

# **TP-6000 SERIES**

## **USER'S MANUAL**

**TOUCH PANEL POS SYSTEM**

**Rev. : Original**





## SOME IMPORTANT NOTES

### FCC NOTES

This equipment generates, uses, and can radiate radio frequency energy and, if not installed and used in accordance with the instructions manual, may cause interference to radio communications. It has been tested and found to comply with limits for a Class A digital device pursuant to subpart J of Part 15 of FCC Rules, which are designed to provide reasonable protection against interference when operated in a commercial environment. Operation of this equipment in a residential area is likely to cause interference in which case the user at his own expense will be required to take whatever measures to correct the interference.

### WARRANTY LIMITS

Warranty will terminate automatically when the machine is opened by any person other than the authorized technicians. The user should consult his/her dealer for the problem happened. Warranty voids if the user does not follow the instructions in application of this merchandise. The manufacturer is by no means responsible for any damage or hazard caused by improper application.

### ABOUT THIS MANUAL

This manual assists the user to utilize the hardware of the TP6000 series that is a member of the POSIFLEX integrated point-of-sale terminal product family. The TP6000 is a compact point-of-sale system that gives the most user friendly human interface by providing touch panel input and combines the performance and affordability of personal computers with the elegance and reliability of business machine. The TP6000 also provides the built-in networking capability for easy communication among multiple terminals in addition to the data transfer and control through back office server.

The manufacturer of the TP6000 series heartily apologizes to the user for reserving the right to change or to modify this manual without notice due to the rapid and constant progress and improvement on science and technology. The user may always obtain the most up to date information through our web sites: <http://www.posiflex.com.tw>, <http://www.posiflexuk.com> or <http://www.posiflexusa.com>

© Copyright Mustek Corp. 2000

All rights are strictly reserved. No part of this documentation may be reproduced, stored in a retrieval system, or transmitted in any form or by any means, electronic, mechanical, photocopying, or otherwise, without the prior written consent of Mustek Corp. the publisher of this documentation.

### TRADE MARKS AND SERVICE MARKS

POSIFLEX is a registered trademark of Mustek Corp..

Other brand and product names are trademarks and registered trademarks and service marks of their respective owners.



# TABLE OF CONTENTS

<b>BRIEF INTRODUCTION</b> .....	1	-	1
<b>THE USER'S MANUAL</b> .....	1	-	1
<b>THE PRODUCT</b> .....	1	-	1
Overview .....	1	-	1
Configuration .....	1	-	1
Available Models .....	1	-	1
Standard Features .....	1	-	2
Optional Items .....	1	-	3
<b>SYSTEM BOX CONTENTS</b> .....	2	-	1
<b>MAIN UNIT &amp; PADDLE ASSEMBLY</b> .....	2	-	1
<b>OPTIONAL DEVICES</b> .....	2	-	2
<b>PARTS IDENTIFICATION</b> .....	3	-	1
<b>FRONT VIEW</b> .....	3	-	1
<b>SIDE VIEWS</b> .....	3	-	2
Right Side View .....	3	-	2
Left Side View .....	3	-	2
<b>REAR VIEW</b> .....	3	-	3
<b>REAR VIEW OF MAIN UNIT</b> .....	3	-	3
<b>ADJUSTABLE PADDLE ASSEMBLY</b> .....	3	-	4
<b>BOTTOM OF PADDLE ASSEMBLY</b> .....	3	-	4
<b>CONNECTORS</b> .....	3	-	4
<b>INSTALLATION GUIDES</b> .....	4	-	1
<b>SEPARATING MAIN UNIT</b> .....	4	-	1
<b>PREPARING PADDLE ASSEMBLY</b> .....	4	-	2
<b>INSTALLING UPS BATTERY</b> .....	4	-	3
<b>ROUTING THE CABLES</b> .....	4	-	3

<b>PREPARING THE MAIN UNIT</b> .....	4	-	4
<b>JOINING MAIN UNIT AND PADDLE</b> .....	4	-	4
<b>OPENING CABLE COVER</b> .....	4	-	5
<b>CONNECTING CABLES</b> .....	4	-	6
<b>INSTALLING CASH DRAWERS</b> .....	4	-	6
<b>WALL MOUNTING</b> .....	4	-	7
<b>LOCATION FOR INSTALLATION</b> .....	4	-	7
<b>USING THE TOUCH POS</b> .....	5	-	1
<b>APPLICATION ENVIRONMENT</b> .....	5	-	1
Ventilation .....	5	-	1
Operating Environment .....	5	-	1
Power Supply .....	5	-	1
I/O Ports Utilization .....	5	-	1
External Monitor .....	5	-	2
Serial Port – COM1 .....	5	-	2
Serial Port – COM2 .....	5	-	2
<b>POWER ON/OFF</b> .....	5	-	3
LED Indicator .....	5	-	3
Hardware Switch .....	5	-	4
Software Support .....	5	-	4
Preset Power On Control .....	5	-	4
<b>MAGNETIC STRIPE READER</b> .....	5	-	5
<b>CASH DRAWER(S)</b> .....	5	-	5
<b>DISPLAY RESOLUTION</b> .....	5	-	6
<b>TOUCH PANEL</b> .....	5	-	6
<b>TOUCH TERMINAL MANAGER</b> .....	5	-	6
<b>RS232 TOUCH MONITOR MOUSE</b> .....	5	-	7

# **BRIEF INTRODUCTION**

## **THE USER'S MANUAL**

The purpose of this manual is to guide the user in the initial installation and general use of the Posiflex fully integrated compact touch terminal system with touch panel input. TP6000 series is a product group of fully integrated PC based touch terminal systems. However, this manual does not intend to explain any application program that may be supplied with the TP6000 systems. The user should consult the software supplier or the VAR that he purchased from for such information. The user is encouraged to visit our web site <http://www.posiflex.com.tw> over the internet for further information of our products.

## **THE PRODUCT**

### **Overview**

The TP6000 series is one of the most compact yet fully integrated touch terminal systems. This series provides on top of its excellent functionality two appearance choices for colors of the enclosure, charcoal and beige.

### **Configuration**

#### **AVAILABLE MODELS**

TP6012P – 12.1” TFT LCD panel, PS2 interfaced touch controller

TP6012R – 12.1” TFT LCD panel, RS232 interfaced touch controller

TP6015P – 15.1” TFT LCD panel, PS2 interfaced touch controller

TP6015R – 15.1” TFT LCD panel, RS232 interfaced touch controller

The choice of color should be specified in addition to the model number identification.

## STANDARD FEATURES

- a) CPU: Celeron 366MHz up to 500 MHz  
HDD: 6.4 GB or above
- b) Support MS DOS, WIN98, WIN NT, WIN 2000 environment (WIN 2000 support starting June 2000)
- c) Power saving support: doze or suspension mode
- d) High quality 12.1" / 15.1" TFT active matrix LCD panel
- e) **Vertical type LCD panel with easy tilt** angle adjustment from 18° to 87°
- f) **Height adjustment:** the high / low adjustment gives 20 mm difference in height
- g) Resistor type touch panel
- h) Extra long life touch panel that endures 10 million up to 35 million touches at same spot
- i) Spill proof water resistant structure allowing easy cleaning
- j) Easy maintenance construction
- k) Various I/O ports supported, including:
  - 1. one PS/2 KB port
  - 2. one PS/2 mouse port
  - 3. 1 (for TP6012R/TP6015R) or 2 (for TP6012P/TP6015P) serial ports with capability for +5V DC support
  - 4. one parallel port
  - 5. 5 USB ports
  - 6. one LAN port 10/100 base T Ethernet
  - 7. one cash drawer connectors for control over 2 cash drawers with drawer open detection
  - 8. one MSR connector
  - 9. one external FDD port
  - 10. one external VGA monitor port
  - 11. one UPS battery connector
- l) **Preprogrammed timer wake up function**
- m) **COM port MODEM ring up function**
- n) **LAN wake up function**

- o) **Built-in UPS function** to support the system from intermittent power failure (battery itself is an option)
- p) **Accidental power off protection** – The power switch is safely located at one side, and this power switch can be defined as a “ON” switch only through software command
- q) **Forced power off** against system malfunction under the power switch on/off mode
- r) **Touch control functions:** left/right button, double click, drag & draw
- s) **Touch sound** can be enabled/disabled or pitch adjusted by software control
- t) High resolution touch sensor: 1024 x 1024
- u) **DRAM memory can extend to 1GB**
- v) Dual display support under OS utilizing multiple display
- w) VGA memory size programmable by software up to **64 MB**
- x) Integrated structure for optional MSR
- y) Software programmable MSR parameters
- z) 2 color choices: **beige** or **charcoal**

### **OPTIONAL ITEMS**

**Note:** The underlined items in the following list means that option must be set prior to shipment from the factory. The rest items can be set by the dealers.

- a) UPS battery
- b) DRAM memory expansion up to 1GB
- c) Integrated MSR of ISO 2 tracks or 3 tracks
- d) 2 in 1 cash drawer control cable CCBLA-238
- e) Preload Windows 98, WIN NT or WIN 2000 (after June 2000)
- f) VFD or graphic LCD stand alone Posiflex pole display
- g) Wall mount kit
- h) External FDD





# SYSTEM BOX CONTENTS

## MAIN UNIT & PADDLE ASSEMBLY

Open the carton

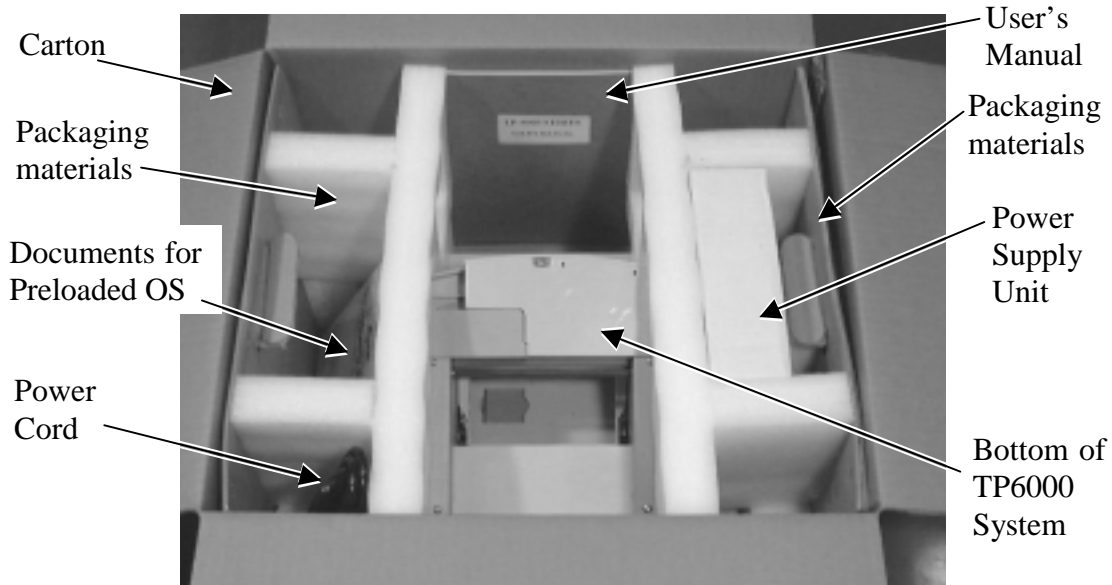

and take all the contents out together with the packaging materials.

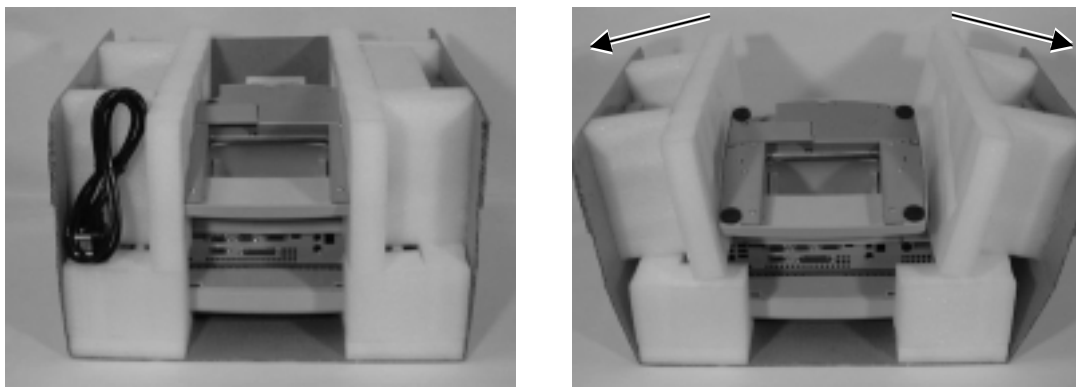

Take out the accessories/options from the partitions in the packaging materials and unfold the packaging materials carefully to unload the upsidedown loaded TP6000 series touch terminal. Put this main unit & paddle assembly aside for the whole Touch POS system installation. Collect if exist other options from the hidden compartments in the packaging materials like external FDD.



The COM1 terminator will be already mounted on the system unit when being shipped. The latch key for cable cover lock will be in a bag.

## OPTIONAL DEVICES

There are several options that will be mounted on/in the main system unit either by the manufacturer if ordered. These optional devices include:

- DRAM expansion – This option includes any possibility from basic 32 MB to maximum 1 GB.
- Built in card reader – This option will be on the right edge when installed. Selectable from two tracks (tracks 1 & 2 or tracks 2 & 3) and three tracks (tracks 1, 2 & 3).
- UPS battery.
- COM1 terminator
- External Floppy disk drive.

There are also some options available to the TP6000 series and they may be delivered in separate packing if ordered. These optional devices include:

- External customer display – Choice between PD2200 series and PD7000 series (or any other Posiflex stand alone customer display).
- POS printer – Choice among PP1000 series, PP2000 series, PP3000 series and PP4000 series with choice between Beige and Charcoal color.
- Cash drawer(s) – Choice among CR3100 series, CR3200 series and CR4000 series. All are provided with two color choices: Beige and Charcoal color.
- Wall mounting kit.
- IW-2000-PSII – RS232 to PS/2 KB wedge convertor.

# PARTS IDENTIFICATION

## FRONT VIEW

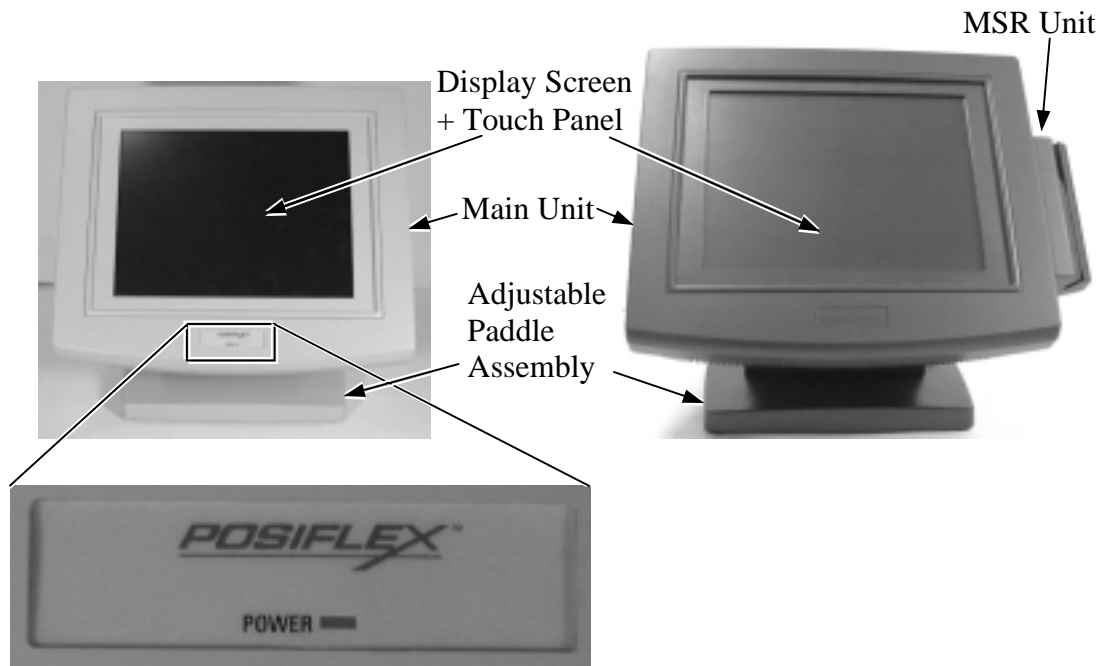

The MSR unit is option to both 12” and 15” models. The LED in the logo area serves for multiple purposes through giving different indication of steady/flashing green/orange light. Please refer to the paragraph discussing the LED indication in the chapter of “USING THE TOUCH POS” of this manual.

## SIDE VIEWS

### Right Side View

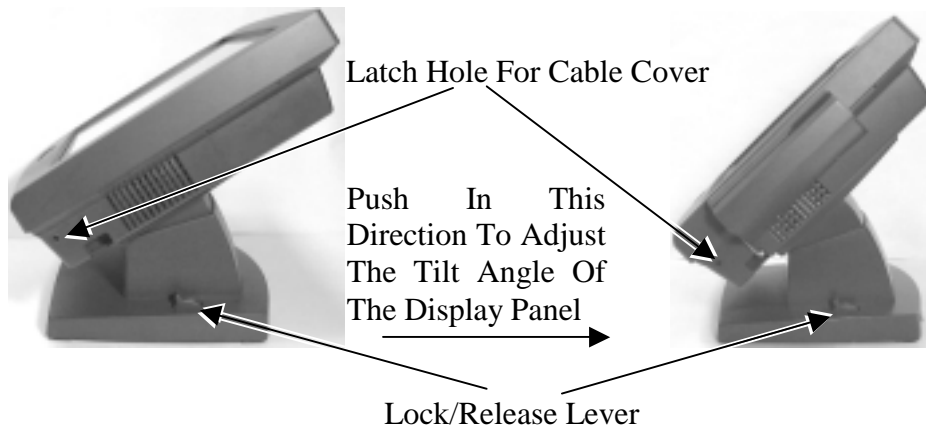

### Left Side View

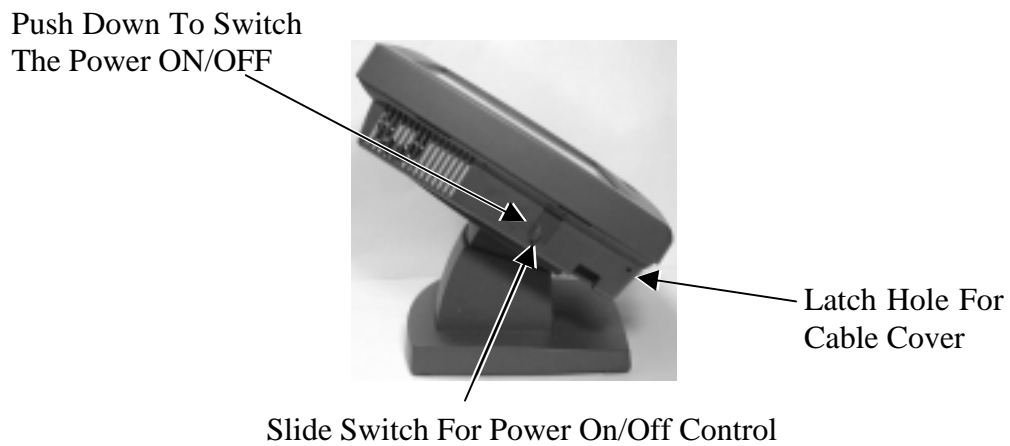

## REAR VIEW

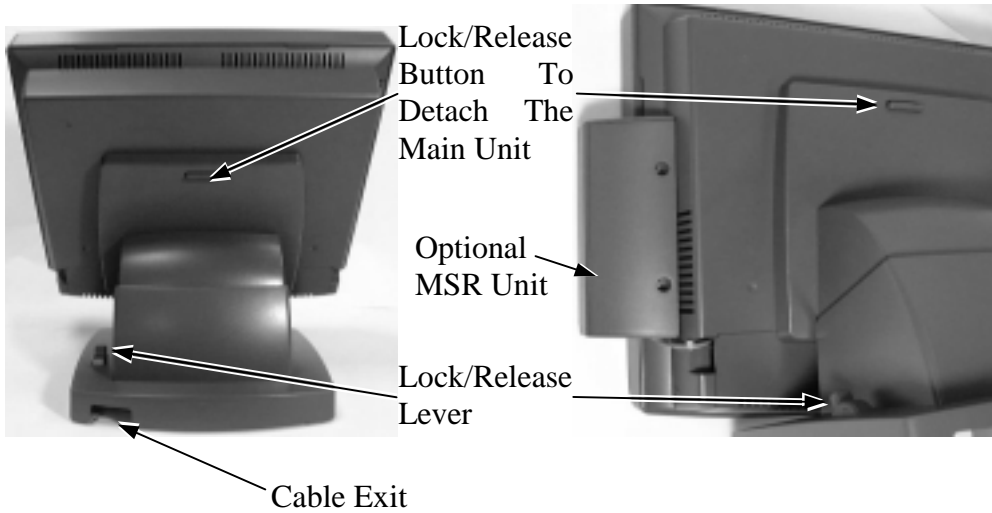

## REAR VIEW OF MAIN UNIT

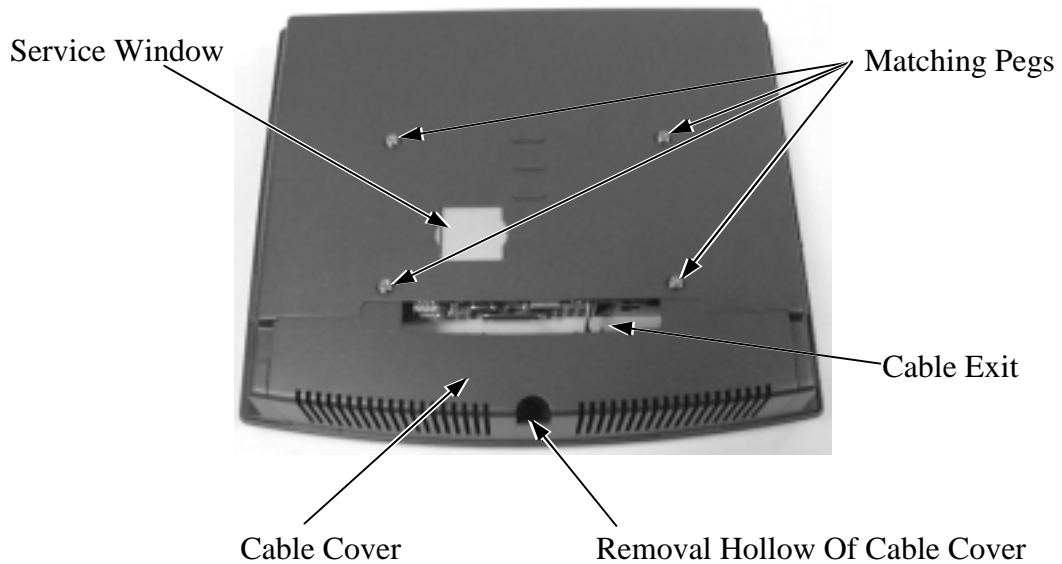

## ADJUSTABLE PADDLE ASSEMBLY

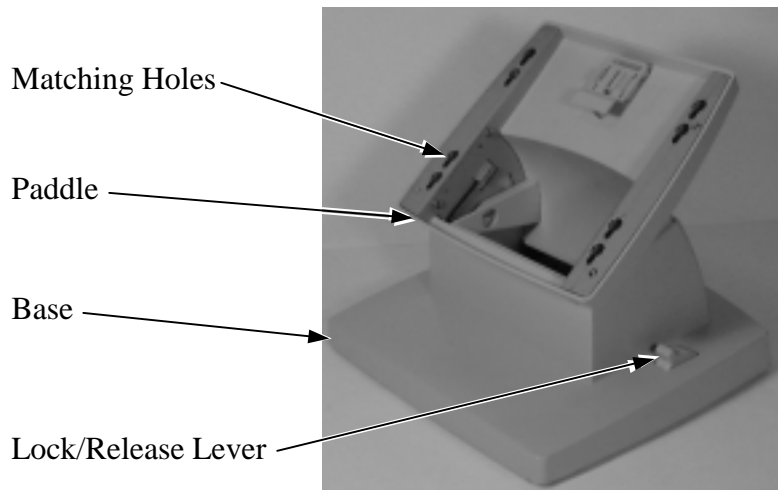

## BOTTOM OF PADDLE ASSEMBLY

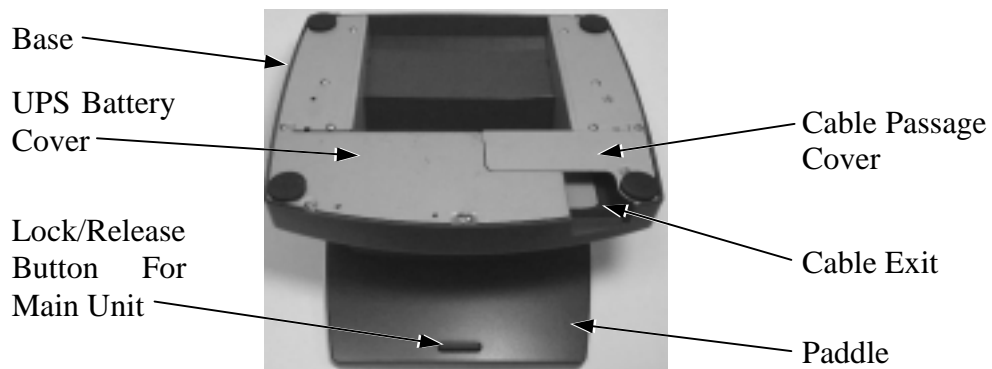

## CONNECTORS

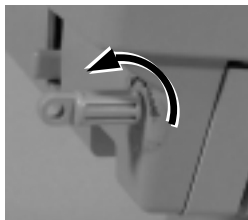

Turn Counterclockwise Then  
Take Out The Latch Key



Pull The Cable Cover  
Out In This Direction

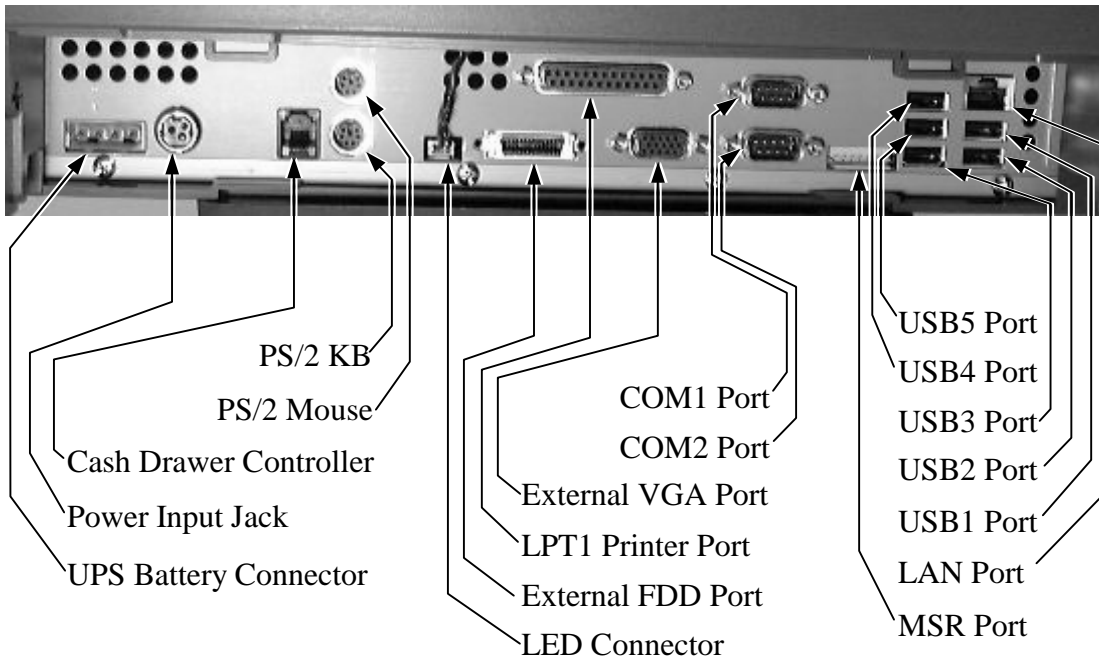





## INSTALLATION GUIDES

**CAUTION:** Before any installation or cable connection to the set, please always make certain that the system is turned off and the external power source to the set is removed to prevent electric hazard! Never touch any metal pin in the connectors or circuits to avoid high voltage hazard or electrostatic discharge damage unless the operator is well grounded.

### SEPARATING MAIN UNIT

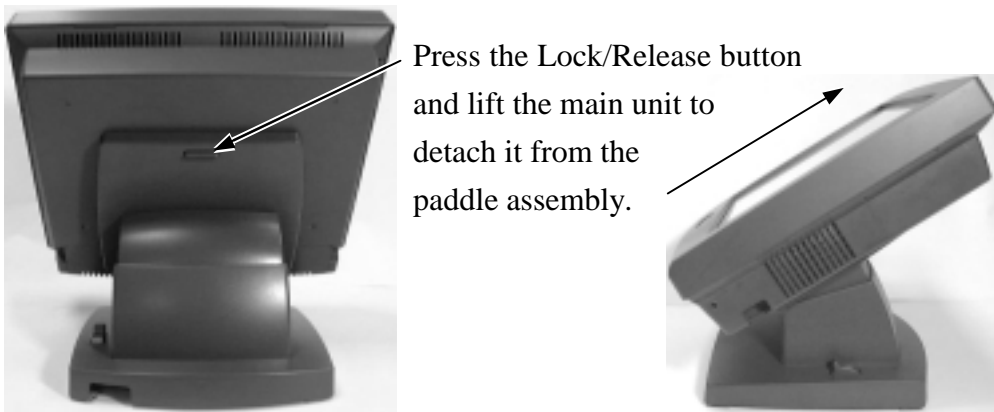

In order to settle the touch terminal properly in a point of sale system, all the cable connections have to be routed through its base, the paddle assembly. Therefore, please press the lock/release button at the rear side to separate the main unit from the paddle assembly.

## PREPARING PADDLE ASSEMBLY

Take the adjustable paddle assembly and turn it up side down to show the bottom of the base.

2 Sets of 4 Matching Holes

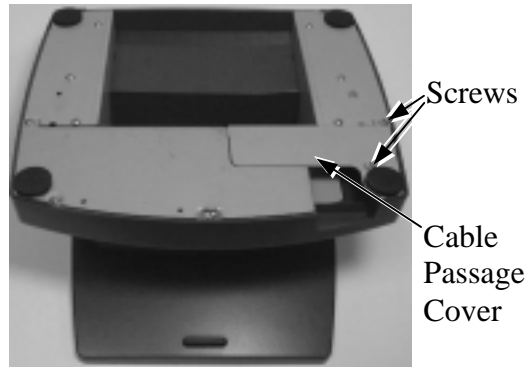
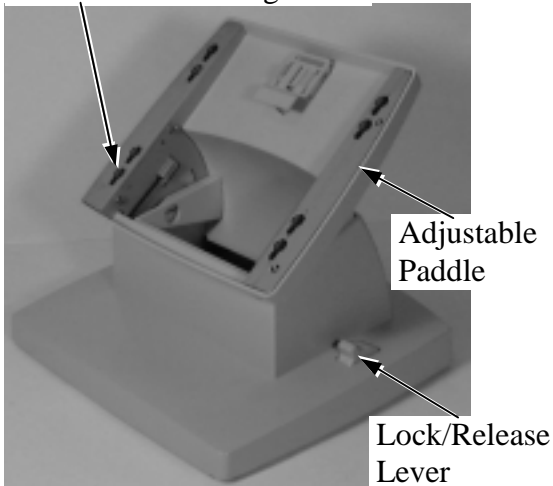

Now, unscrew the 2 screws on the cable passage cover and take the cable passage cover away to show the cable passage.

If there is no need to install the optional UPS battery here (either not to be installed or already installed), please skip the next paragraph and directly start routing cables through the cable passage. Otherwise, please remove the four screws holding battery cover to install the battery.

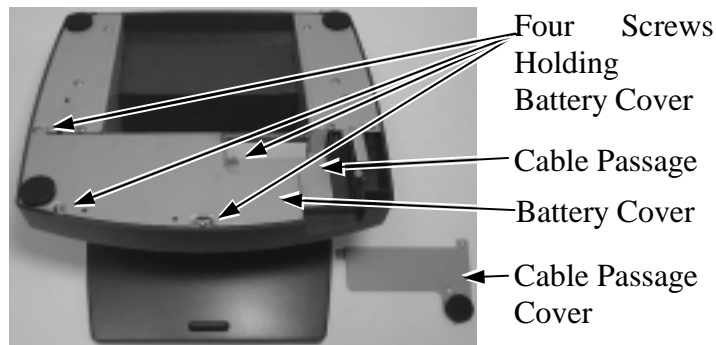

## INSTALLING UPS BATTERY

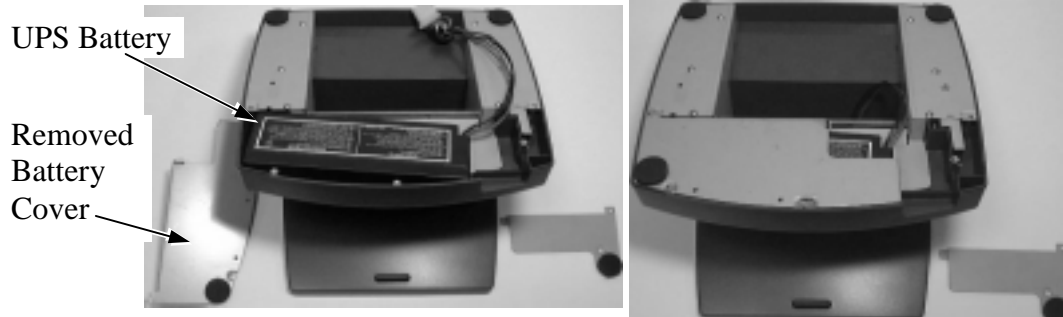

Place the optional UPS battery in the battery compartment in the way as indicated in the picture. Screw on the battery cover and join the battery cable into the cable routing operation. Please enable UPS function in software setting before use.

## ROUTING THE CABLES

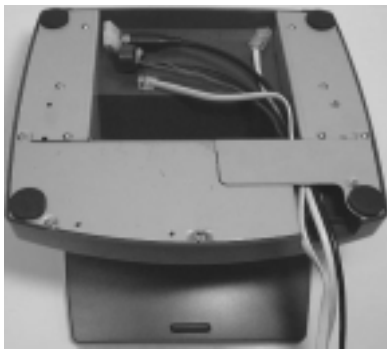

Place all the cables required for connections to the TP6000 series except those for special application purposes into the cable passage. Inset one end of the cable passage cover under the battery cover and screw on the two screws. Be sure not to damage any of the cables during this operation.

Now, turn the adjustable paddle assembly back to normal orientation and arrange all cables to come out of the area for mounting main unit from the bottom edge for ease of later operation.



## PREPARING THE MAIN UNIT

On the back of the main unit, there are 4 matching pegs and a service window. Push open the service window in the direction as indicated in the picture, one can find a button cell battery socket, a 1 x 3 header (JP10) with 1 jumper and a 2 x 3 header (JP8) with 2 jumpers.

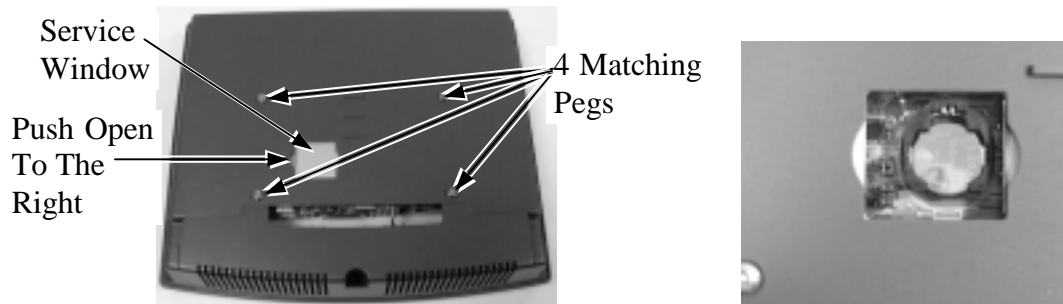

This battery socket accepts a 3 V button cell Lithium battery (CR2032) required to support the system real time clock. The jumpers in this window are designated for COM port power supply and UPS battery detect function. Please consult your dealer for technical support on setup of these jumpers. A new Lithium battery can support the system RTC for about 3 years. After the battery is nearly exhausted, the user must change a new battery otherwise the system RTC and system configuration setup will be lost.

## JOINING MAIN UNIT AND PADDLE

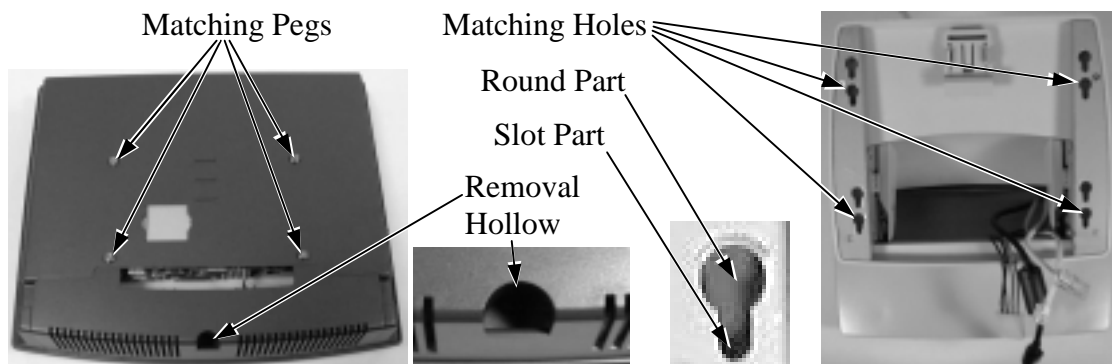

Match the matching pegs on the back of the main unit against one of the two sets of matching holes on the paddle. It is recommended to hook on the lower set of holes for better stability. First aim the matching pegs toward the upper round part of

the hole and make sure that all pegs are inside the holes. Then slide the main unit down to move the pegs into the lower slot part of the holes till it clicks. Note that all the cables come out of the paddle from the lower edge and won't get trapped by this mounting operation. If later on you want to remove the main unit from the paddle, you'll have to press down the lock/release button on back of the paddle at the time lifting the main unit.

## OPENING CABLE COVER

Insert the tip of the latchkey into a latch hole on one side near bottom of the main unit. Turn this key counterclockwise to the end. Do the same on the opposite side. **Be sure to take the key out of the hole.**

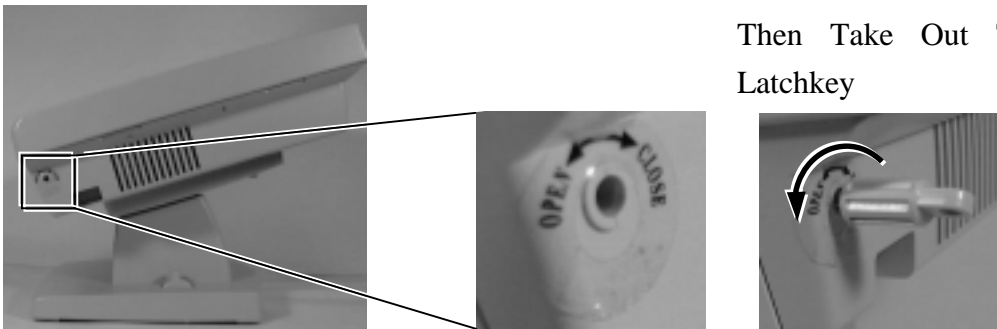

Turn Counterclockwise  
Then Take Out The  
Latchkey

Then push the lock/release lever on the base backward to adjust the paddle to the most horizontal position for ease of operation. Open the cable cover by pulling at the removal hollow.

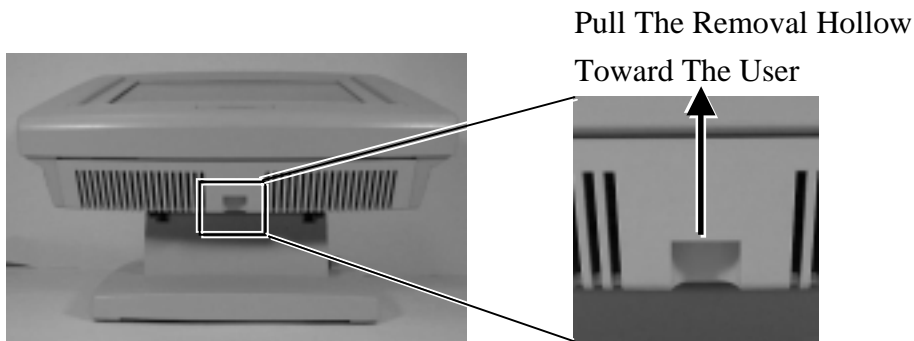

Pull The Removal Hollow  
Toward The User

## CONNECTING CABLES

Connect the cables required to the appropriate connectors. Please make sure that each connector has to be connected to the right port in the right orientation. Some connectors have to be inserted till a click is heard such as the LAN connector, the external FDD connector, the power connector and the cash drawer connector. It is recommended to screw on the connector once it is inserted such as the external VGA connector, the LPT port connector and the COM port connectors. If COM1 port is to be used, you would have to take down the COM1 terminator that is already mounted on the COM1 port. However, it is highly suggested not to use for any serial device that does not provide proper handshaking signals such as a serial mouse in order to keep cash drawer control function. Adjust the slack of each cable and close the cable cover. Use the same latch key as when opening the cable cover but this time turn it clockwise on both sides to secure the cable cover on the main unit. Adjust the tilt angle of the main unit for best viewing effect in the application.

**CAUTION: Before doing any insertion or extraction of the power plug, be sure to pull always the outer sleeve of the plug backward to release the internal latch. Failure to do this could damage the power plug. Such damage is considered as an artificial destruction and is not covered by the warranty.**

## INSTALLING CASH DRAWERS

When there is only one cash drawer to be installed, just connect the standard cable CCBLA-180 that comes with the cash drawer to the right RJ11C jack (be careful, not the adjacent one left for MODEM).

When there are two cash drawers to be installed, please purchase and use the optional split cash drawer control cable CCBLA-238 for the purpose of controlling two cash drawers in the TP6000 series. The CCBLA-238 has a 6 pole plug at one end and two 8 pole plugs at the other. The 6 pole plug should be inserted in the connector marked "CR" found in the rear compartment of the terminal. Each 8 pole plug should be inserted into the connector marked "signal cable from POS Printer" at the rear of one of the cash drawer. The cable lengths for the two 8 pole plugs are different. Use

the shorter one for the original cash drawer “CR1” and use the longer one for the extended cash drawer “CR2” that will be distinguished by the software command. In this way, the TP6000 is capable of controlling two cash drawers independently through software command.

## WALL MOUNTING

The major part in the wall mounting kit is a bracket as shown in the picture. Screw the bracket against the wall for mounting the TP6000 series in the direction that the wider parts of the matching holes are at the top as shown in the picture. Align the four matching pegs on the back of the main unit with the four matching holes in the bracket to hold the main unit in the similar manner as installing the main unit onto the paddle assembly. The paddle assembly is not engaged in wall mount operation.

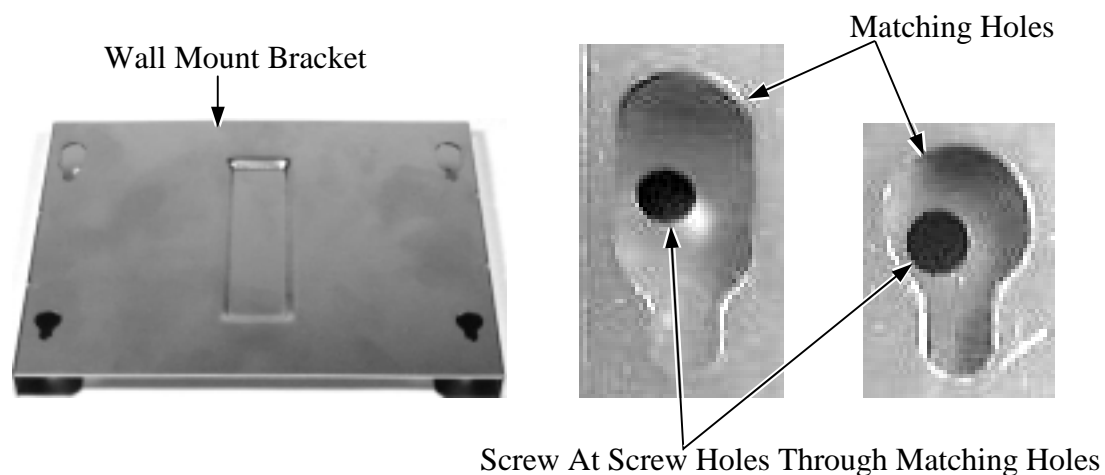

## LOCATION FOR INSTALLATION

As the paddle assembly is not involved in wall mount installation, the space required for wall mount application will take only the main unit into consideration. So the space required is 375 mm in width and 315 mm in height.

For desk top/counter application, the adjustable paddle assembly requires a base of 270 mm deep and 260 mm wide. However, please take also the main unit into consideration. If the main unit is tilted to near vertical position, the total height can be



either 360 mm or 380 mm depending on the position adjusted. When the main unit is tilted to near horizontal position, the total height required is 275 mm.



# USING THE TOUCH POS

## APPLICATION ENVIRONMENT

It is **very** important that you check the following operational guidelines:

### Ventilation

This terminal must **NOT** be operated in an environment with restricted ventilation. The installation should be such that there is at least 25mm air clearance around any top or side ventilation holes. The installation must also be such that there is a free flow of air around the unit at **ALL** times.

### Operating Environment

The equipment must not be operated or stored in extremes of both temperature and humidity/moisture.

(Operating range 5°C to 35°C and up to 80% humidity – non condensing)

### Power Supply

The operating voltage range of the power adaptor should cover the local power supply for proper operation. The power cable, the power outlet and any power fusing arrangements must conform to local safety regulations.

### I/O Ports Utilization

The TP6000 series, designed to accommodate today's and tomorrow's technology, has an adequate yet not vast number of I/O ports as limited by spacial conditions. Therefore, selection on the peripheral device type and the port utilized now requires some special attention. Here are some recommendations on the device application:

- Serial customer display – use USB to RS232 adapter to connect to USB port or directly connect to COM1 port
- MODEM – use USB modem
- MSR – this option is internally connected to KB wedge.

- Parallel printer – connect to Parallel port
- Serial printer – use USB to RS232 adapter to connect to USB port or directly connect to COM1 port
- Serial barcode scanner – use IW-2000PS2 (RS232 to KB wedge converter) to connect to PS2 KB port
- Cash drawer – connect to CR port
- Serial Weight scaler – use IW-2000PS2 (RS232 to KB wedge converter) to connect to PS2 KB port
- Mouse – use PS2 mouse or USB mouse
- KB – use PS2 KB or USB KB
- Touch panel controller – please select the standard PS2 interfaced model to free up a serial port COM2.

Should all the recommendations above fail to satisfy the customer's needs, please check other Posiflex product series such as TP3000 series or other PST series.

## **External Monitor**

The external VGA port in the TP6000 series supports any regular VGA monitor using separate AC power up to resolution 1024 x 768 with true color. Unlike other Posiflex POS terminals, the DC powered 9" VGA mono monitor is not supported by this series.

## **Serial Port – COM1**

**CAUTION: COM1 serial port must always be occupied by either a suitable serial device or COM1 terminator** (as supplied). Without this provision the cash drawer control ports will fail to work correctly.

The most recommended devices for COM1 are either an external customer display or a serial POS printer. When such devices are to be installed to the TP6000 series, please remove the COM1 terminator and store in a safe place for future use.

## **Serial Port – COM2**

This is a standard RS232 serial port. However, this port is not available for the models with RS232 interfaced touch controller (TP6012R, TP6015R). Any attempt to break the cover of this port will void the product warranty.

## POWER ON/OFF

### LED Indicator



There is an LED in the logo area that serves for multiple purposes.

- When the TP6000 is standing by for powering up in the presence of external power supply, the LED is orange.
- When the TP6000 is powered up and working normally with the external power supply, the LED is green.
- When the external power extinguishes and the TP6000 is working on the optional UPS battery power, the green LED flashes.
- When the optional UPS battery is going to exhaust by supporting the TP6000 in the absence of the external power, the orange LED flashes rapidly.
- When the TP6000 is turned off and the external power disappears, the LED is off.

This system will not allow powering the system up in the absence of an external power supply.

The maximum total power consumption of the external power supply unit is 1.6 A at 115 V AC or 0.8 A at 230 V AC.

## Hardware Switch

The power switch located at left side of the main unit is a slide type switch. This switch controls the power on/off of the system. This switch turns the system on when slid downward at original power connection status or power off status. The switch will always spring back to its original position when external force is removed. This switch turns the system off when slid downward again at power on status. However, if the system hangs due to any reason such as software resource conflict a simple slide of the switch may fail to turn off the power. In this case, please utilize the **forced power off feature** by pressing the switch down for continuously 4 seconds.

However, this switch can also be programmed into an ON only switch. That means, if the application program issues certain command according to the technical manual of this TP6000 series, this switch will always turn the system on when activated and meantime the forced power off feature does not apply in this mode. Of course, the application program shall take care of the means for turning the system off.

## Software Support

The TP6000 series provides a software power off command for the application program maneuvers. The TP6000 also provides a specific means for the software to detect if the system is working on external or UPS battery power. So the application program can operate in split strategy against normal and AC fail conditions. The software programmer may take reference from the technical manual of this TP6000 series for above purposes.

## Preset Power On Control

The system may also be turned on according to some predetermined parameter such as Modem Ring Up and Alarm Clock Wake Up or LAN Wake Up.

To utilize such function, the user should enter the CMOS setup by pressing "DEL" key at system boot up, choose for "INTEGRATED PERIPHERALS" and make the "Ring Power Up Control" enabled for Modem Ring Up or select the "Power Up by Alarm" for Alarm Clock Wake Up. Save the configuration and exit the CMOS setup program. The Preset Power On Control will then be ready. However, for LAN Wake Up function, certain specific program has to be executed before power off. This

program shall prepare the terminal to standby for LAN Wake Up during power off so that when the predefined condition is met (LAN status change or receiving certain packet) the TP6000 will be powered on.

When the TP6000 system is turned off after a successful boot up, the defined preset power on functions will keep monitoring for the preset conditions. When a Modem call or LAN Wake Up Packet is received, the system will be turned on and start to work according to the security conditions as the application program defines if the Ring Power Up Control or LAN Wake Up function is enabled. If the Power Up by Alarm is enabled, the TP6000 system will be turned on at the defined time (Hour : Minute : Second) of the preset day of week, day of month, month of year or even every day if these items are not defined.

Please note that if the TP6000 system is improperly turned off before a complete boot up procedure, the above preset power on control functions will be disabled until next turning off after a complete boot up.

## **MAGNETIC STRIPE READER**

The magnetic stripe reader, if installed, will be mounted on the right edge of the TP6000 series. When reading an ISO standard magnetic card, please face the magnetic stripe to the center of TP6000 series and slide the card downward through the slot.

## **CASH DRAWER(S)**

The cash drawer control port, if connected with Posiflex cash drawer, provides not only a way to open the cash drawer through software commands but also a detection method for the software to check the drawer open status for consequent security measures.

The TP6000 series provide one cash drawer connector for control over two cash drawers. This unified CR connector, if connected with a standard cable CCBLA180 that is an accessory of the Posiflex cash drawer CR3100 or CR3200, controls one cash drawer. When an optional split cash drawer control cable CCBLA238 is used with this unified CR1 connector, this connector controls two cash drawers according to the software commands.

## **DISPLAY RESOLUTION**

For best viewing result please set your display resolution of TP6012 at 800 x 600 with true color in the operation system. For TP6015, please set the display resolution at 1024 x 768 with high color.

## **TOUCH PANEL**

The touch panel in TP6000 series, either PS2 interfaced or RS232 interfaced, when its driver is properly installed, works exactly like a standard mouse. However, if the system is running under safe mode due to a previous improper shutdown or any reason else, most drivers are disabled in this mode and the point touched may be off calibrated from the mouse pointer shown. It is recommended to apply a standard PS2 mouse or keyboard for data input in this mode.

All the below mentioned mouse emulation functions can be manipulated through relevant software. The system can give a beep when the touch panel is touched and can respond as if the left button of a PS2 mouse is clicked at the point touched. If the point touched is dragged across the screen surface, it can respond as if the mouse is dragged across with left key pressed. If the point is touched, released and touched within a short time interval, it can work just like double-clicking the mouse. For the standard PS2 interfaced touch panel controller, touching the screen for a while followed by a slight move of the touch without leaving the screen surface can result as a click on the right button of the mouse at that point. For the RS232 interfaced touch panel controller, touching any point on the screen surface after touching the right-click sticky button results as a click on the right button of the mouse at that point. However, the right button function is not applicable under WIN NT environment.

## **TOUCH TERMINAL MANAGER**

The touch panel control parameters are already well calibrated in the factory before delivery. In principal the touch panel requires no further touch up once properly set. However, a program named "Posiflex Touch Terminal Manager" is installed in the preloaded Windows system for the user to maneuver versatile features of the touch terminal with PS2 interfaced touch panel controller. This program can

also be obtained through downloading from our web site. Application of this program provides control over the MSR, the touch panel and the power control of the Posiflex Touch Terminal. For an RS232 interfaced touch panel, the touch panel part of the following description should be disregarded and please refer to the paragraph “RS232 TOUCH MONITOR MOUSE” instead.

This program controls software gating of data read from each MSR track and the way data is sent from the reader to the system including the coding method against language systems, data transmission speed, delivery and selection on leading/ending code of each track to be sent to the system.

This program also controls the beep generated when the touch panel is touched, the detail in right button click emulation and provides touch panel re-calibration.

This program can also be used to define the power switch to be on only or on/off switching, the delay time before software power off and whether an UPS battery is engaged in the power control system.

## **RS232 TOUCH MONITOR MOUSE**

If the product model purchased is TP6012R or TP6015R, the touch panel controller used is the RS232 interfaced controller. The “Touch Panel Manager” of the above “Posiflex Touch Terminal Manager” should be discarded and a separate software Monitor Mouse should be used. In these models, the connector COM2 will be plugged with a cover to inhibit any use of this port other than the connected RS232 touch controller. **Removal of this cover voids the product warranty!!**

In principle, the driver for the RS232 touch controller is installed with the systems equipped with the RS232 touch controller. However, if a re-installation is required, please select “SmartSet Serial Controller on COM2” for controller type selection during the installation process.

Once the RS232 touch controller is installed, the user can utilize it to calibrate the touch screen, to define mouse button emulation mode, to enable right button emulation or to define the click sound’s tone and duration. Please click “Start”, “Setting”, “Control Panel” and “Elo Touchscreen” to engage this utility.



If, for any reason, the user wants to remove the driver for the RS232 touch controller, please select “Monitor Mouse for Windows 95” in the program list for removal.



## Free Manuals Download Website

<http://myh66.com>

<http://usermanuals.us>

<http://www.somanuals.com>

<http://www.4manuals.cc>

<http://www.manual-lib.com>

<http://www.404manual.com>

<http://www.luxmanual.com>

<http://aubethermostatmanual.com>

Golf course search by state

<http://golfingnear.com>

Email search by domain

<http://emailbydomain.com>

Auto manuals search

<http://auto.somanuals.com>

TV manuals search

<http://tv.somanuals.com>