



Displays your heart rate as bpm and % of HR<sub>max</sub>, average heart rate and exercise duration.



Allows you to set 5 exercise sets for interval training with HR target zones and recovery calculation. Records complete files of the exercises.



Predicts your maximal oxygen uptake.



Reduces possible interference from other heart rate monitors.



Sports watch features.



Infra red communication allows two-way exchange of settings and exercise data with a PC.

**S610i™**  
HEART RATE MONITOR

**POLAR®**



USA/GBR

USER'S MANUAL

**S610i™**  
HEART RATE MONITOR

**POLAR®**

## Quick Guide

Signal/Light



▲ Up

- move onward
- increase the selected value

■ Stop

- exit the displayed mode
- return to the Time of Day display

▼ Down

- move backward
- reduce the selected value

○ OK

- start measuring the heart rate
- lock in your selection

### How to Start Measuring Your Heart Rate (BasicUse)

1. Place the transmitter around your chest and wet the electrodes. Place the receiver on your wrist.
2. Press and hold the OK button to start the measurement. The stopwatch and the exercise recording start. Your heart rate will appear in about 15 seconds.

### How to Stop Measuring Your Heart Rate

1. Press the stop button. The stopwatch and other calculations stop. Heart rate measurement continues but exercise data is not recorded into a file anymore.
2. Press the stop button again. The receiver returns to Time of Day display.

# Road Map

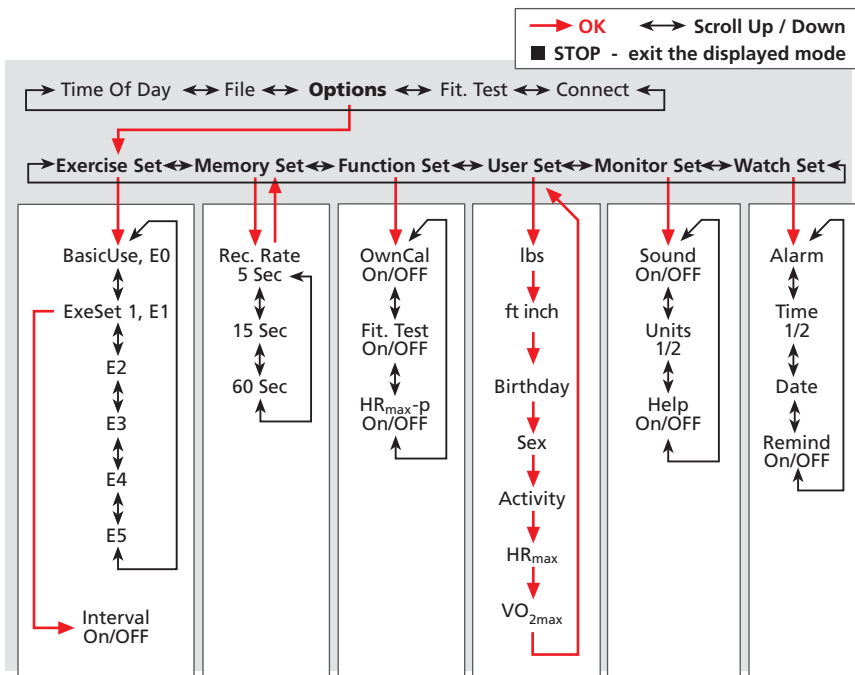

## Dear Customer

Congratulations on purchasing a Polar Heart Rate Monitor! We are proud to assist you in achieving personal fitness and performance goals. If you want to get even more out of your Polar heart rate monitor during training, check our web sites for the best product and training tips, software updates and other value added services:  
 USA and Canada: [www.polarusa.com](http://www.polarusa.com)  
 Other countries: [www.polar.fi](http://www.polar.fi)



Manufactured by:  
 Polar Electro Oy  
 Professorintie 5  
 FIN-90440 KEMPELE  
 Tel. +358-8-520 2100  
 Fax +358-8-520 2300  
[www.polar.fi](http://www.polar.fi)

**POLAR**<sup>®</sup>

The Polar heart rate monitor offers you various ways to customize your exercise sessions so they meet your personal needs.

For example, use the Interval Trainer™ function to guide you through a complete interval training session. Or, you can choose the functions that suit you best: OwnCal® calorie calculation, timers, recovery calculation, etc. After training, you can review your exercise file and transfer it to your computer for analysis with Polar Precision Performance™ software. Monitor your fitness level, and any long-term changes in it, by performing the quick and easy Polar Fitness Test™.

Please read this manual carefully to familiarize yourself with the Polar heart rate monitor. This is where you can find the information you need to use and maintain your equipment. The function road map on the front cover is a quick guide to the versatile features of the Polar heart rate monitor. Please tear it off and save it for your reference.

Please refer to the glossary for special terms, display symbols and text explanations. The alphabetical index will help you quickly find answers to any questions that you might encounter while using your Polar heart rate monitor.

Thank you for choosing Polar!

Download from [Www.Somanuals.com](http://www.Somanuals.com). All Manuals Search And Download.

# CONTENTS

## **A. Getting Going ..... 5**

Heart Rate Monitor Parts .....	5
Buttons and Their Functions .....	6
Easy Start .....	8
How to Prepare the Wrist Receiver ...	8
How to Put the Transmitter On .....	9
How to Start Measuring	
Your Heart Rate .....	9
How to Stop Measuring	
Your Heart Rate .....	10
After Exercising .....	10
Modes and Their Functions .....	11

## **B. How to Enter Settings ..... 16**

User Information Settings .....	18
Exercise Settings .....	21
Selecting Exercise Type .....	21
Setting Exercise Sets .....	22
Setting Timers .....	24
Setting Heart Rate Limits .....	24
Turning Heart Rate Limits on/off ..	24
Setting Interval Type .....	25
Setting Number of Intervals and	
Recoveries .....	26

Setting Recovery Calculation .....	26
Naming Exercise Sets .....	27
Setting Recording Rate .....	28
Turning Functions on/off .....	29
OwnCal Calorie Counter on/off .....	29
Fitness Test on/off .....	29
Predicted Maximum	
Heart Rate on/off .....	30
Monitor Settings .....	30
Turning Activity/Button	
Sound on/off .....	30
Selecting Measuring Units .....	31
Turning Help on/off .....	31
Watch Settings .....	32
Setting Alarm .....	32
Setting Time of Day .....	32
Setting Date .....	33
Turning Reminders on/off .....	33
Setting Tips .....	34
Swap Time 1 or Time 2 .....	34
Shortcut to Watch Settings .....	34
Swap Measuring Units .....	34
Swap Date, User ID number,	
User Name and Logo .....	34

## **C. Exercise ..... 35**

Heart Rate Measure Mode .....	35
Exercise Recording Mode .....	37
Turning Heart Rate Zone Alarm on/off .....	37
Swapping the Heart Rate Limits .....	38
Illuminating the Display .....	38
Storing Lap and Split Time .....	39
Pausing the Exercise .....	39
Swapping the Displayed Exercise Information .....	40
Resetting the Stopwatch to Zero .....	41
Starting an Exercise Set .....	42
Exercising with Interval Training Set ...	42
Warm-up Phase .....	43
Interval Phase .....	44
Cool-down Phase .....	46
Interrupting an Interval Training Exercise .....	47
Exercising with BasicSet .....	47
Starting the Timers .....	47
Starting Recovery Calculation .....	48
Stopping the Exercise .....	48

Tips During the Exercise .....	48
Swapping the Recording Rate .....	48
Swapping the Exercise Type .....	48
Restarting the Interval or Recovery Calculation .....	49
Interrupting an Interval or Recovery Calculation .....	49
Interrupting a Phase of Interval Training Exercise .....	49
Heart Touch Function .....	49

## **D. How to Recall Training Information ..... 50**

Exercise Time .....	53
Recovery Information of BasicSet .....	53
Heart Rate Limits .....	53
Exercise Time within, above and below the Heart Rate Zones .....	54
Calorie Expenditure .....	54
Cumulative Calorie Count .....	54
Cumulative Exercise Time Count .....	54
Interval Training Information .....	55
Lap Information .....	57

Recorded Heart Rate Samples .....	58
Records File .....	58
Resetting Cumulative Counts to Zero ...	58
Deleting a File .....	59
Deleting All Files .....	59

## **E. Connection to Computer .... 60**

Downloading Training Data to Computer .....	60
Uploading Settings from Computer ....	61

## **F. Polar Fitness Test ..... 63**

OwnIndex .....	63
Predicted Maximum Heart Rate .....	65
Fitness Test Settings .....	66
Carrying Out the Test .....	66
Update OwnIndex and $HR_{max-p}$ .....	68
Fitness Classes .....	69

## **G. Care and Maintenance ..... 71**

## **H. Precautions ..... 73**

## **I. Frequently Asked Questions ..... 77**

## **J. Technical Specifications ..... 81**

## **K. Limited Polar International Guarantee ..... 84**

## **L. Disclaimer ..... 85**

## **M. Polar Glossary ..... 86**

Display Symbols .....	88
Display Texts .....	89
Index .....	92

# A. GETTING GOING

## Heart Rate Monitor Parts and Their Functions

The elastic strap holds the transmitter comfortably, yet firmly, in the correct position.

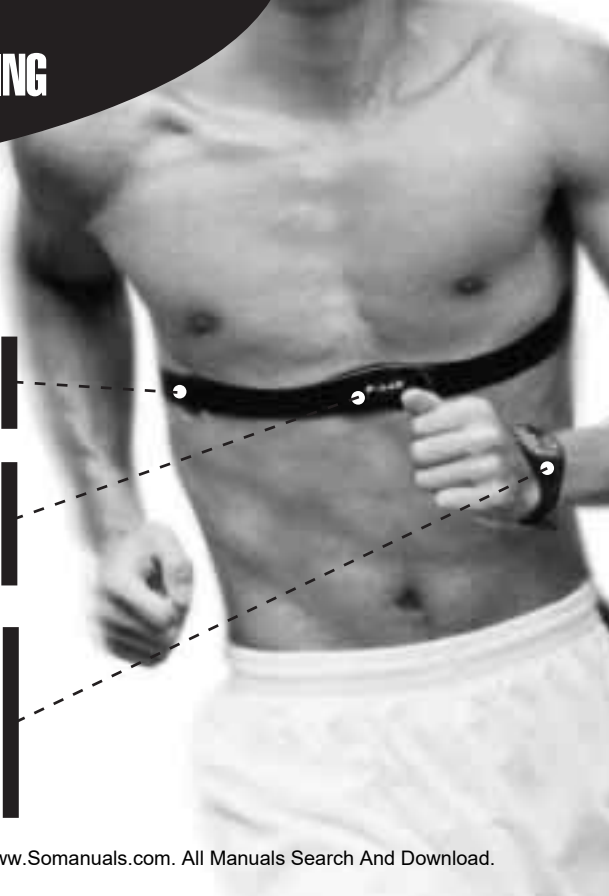
A black and white photograph of a man's torso and arms. He is wearing a black chest strap heart rate monitor. Dashed lines connect three text blocks on the left to specific parts of the device: the top line points to the chest strap, the middle line points to the transmitter on the chest, and the bottom line points to the wrist receiver. The man is also wearing a wristwatch on his left wrist.

The transmitter detects your heart rate and transmits it to the wrist receiver.

The wrist receiver displays your heart rate and other data during exercise. Enter your personal settings into the receiver and analyze the exercise files after you're done.

## Buttons and Their Functions

### Signal/Light

Turns the beep on or off.  
Turns the backlight on.



### Reset

Resets the heart rate monitor.

RESET

### Stop Return

Stops measuring the heart rate.  
Exits the displayed mode and returns to the previous mode level.  
Returns to the Time of Day display from any mode by pressing and holding the stop button.



### OK Accept

Starts measuring the heart rate (start).  
Enters the displayed mode shown on the lower level (start). Locks in your selection (ok). Records lap information (lap). The Help text (start, ok or lap) that appears on the display above the button indicates its use.

OK



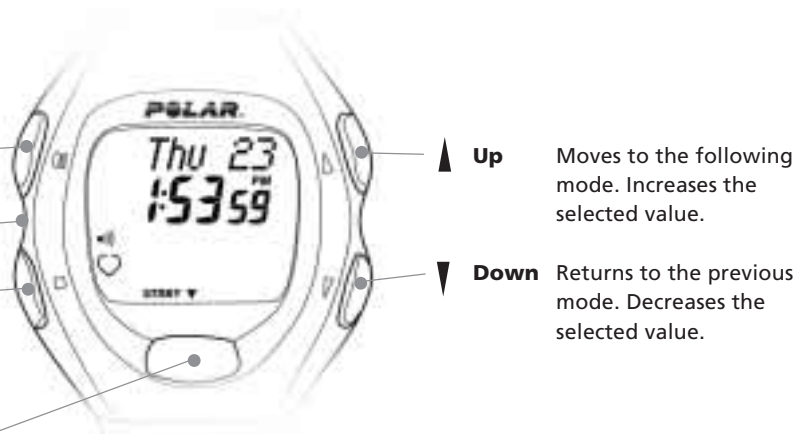

▲ **Up**

Moves to the following mode. Increases the selected value.



**Down**

Returns to the previous mode. Decreases the selected value.



### Useful Tips

- Briefly pressing a button (approximately 1 second) will do different things than pressing and holding the button for a longer period of time (approximately 2 to 5 seconds). If you press the button for a longer period of time, you can use shortcuts.
- The buttons are slightly stiffer than those of an ordinary watch to prevent them from being pressed accidentally.
- You can always return to the Time of Day display from the Options setting or File recalling loops by pressing and holding the stop button.
- See the glossary for display symbols and text interpretation.

Download from [www.Somanuals.com](http://www.Somanuals.com). All Manuals Search And Download.

### How to Prepare the Wrist Receiver

1. Since the display is blank when the receiver leaves the factory, you have to activate the wrist receiver by pressing the OK button twice, after which the Time of Day display appears. This is a one-off procedure; once you have turned on your receiver you can not turn it off anymore.
2. You may start measuring your heart rate right away using the default settings. However, the following settings are ones that it would be useful to change as soon as possible: Time of Day (see section Watch Settings) and personal user settings (see section User information settings).
3. Polar heart rate monitor has various functions that you can use according to your personal training needs. For more information, see section Modes and their functions. You can either manually enter the settings by pressing the receiver buttons or you can define your settings using Polar Precision Performance software, after which the data should be transferred from your computer to the wrist receiver.
4. Wear the wrist receiver as you would wear an ordinary watch. If you go biking, we recommend attaching the wrist receiver to a Polar Bike Mount™.

## How to Put the Transmitter On

1. Attach the transmitter to the elastic strap.
2. Adjust the strap length to fit snugly and comfortably. Secure the strap around your chest, just below the chest muscles, and buckle it.
3. Lift the transmitter off your chest and **moisten the grooved electrode areas** on the back.
4. Check that the wet electrode areas are firmly against your skin and the Polar logo is in a central, upright position.

## How to Start Measuring Your Heart Rate

1. Begin with the display that shows the time of day.
2. Keep the wrist receiver within 3 feet/ 1 meter of your transmitter.
3. Check that you are not near people that have heart rate monitors, high voltage power lines, televisions, mobile phones or other sources of electromagnetic disturbance.



4. Press the OK button to start measuring your heart rate. A heart symbol will start flashing and your heart rate (beats per minute) will appear in a maximum of 15 seconds.
5. Press OK again. The stopwatch starts running and you can start exercising. The exercise data will only be stored in a file if you have turned the stopwatch on.

### **How to Stop Measuring Your Heart Rate**

1. Press the stop button. The stopwatch and other calculations stop. The heart rate measuring continues, although exercise data is no longer recorded.
2. Press the stop button again. The heart rate measuring stops. The receiver shows the Time of Day display again.

### **After Exercising**

1. Carefully wash the transmitter with a mild soap and water solution.
2. Rinse it with pure water.
3. Dry the transmitter carefully with a soft towel.
4. Store the transmitter in a clean and dry place. Dirt impairs the conductivity and functioning of the transmitter. Sweat and moisture can keep the electrodes wet and the transmitter activated, which shortens battery life.

## Modes and Their Functions

Your Polar heart rate monitor has six main modes: Time of Day, Exercise, File, Options, Fitness test and Connection.

### 1. TIME OF DAY

You can use your Polar heart rate monitor as an ordinary watch that shows the date and the day of the week, as well as contains an alarm function. You can also change between two different countries' time zones. In addition, the following functions can be uploaded from a computer and utilized:

- 7 alarm sound reminders
- your personal logo, user number or user name

### 2. EXERCISE

In the Exercise mode, you measure your heart rate and exercise information is recorded in the File mode. You can preset up to five exercise sets for your personal needs. You can also name these exercises on your receiver. When you start exercising, just select one of the saved sets. Or, you can select BasicUse (heart rate measurement without heart rate limits, timers or other exercise guiding functions).

**A. During BasicUse**, you can save 99 split and lap times with current, maximum and average heart rates for each lap. You can configure the display to show information on the following:

- your current heart rate, average heart rate or a reading of your maximum heart rate in percentages
- the current exercise time (stopwatch)
- time of day
- current lap and split time as well as the lap number
- calorie count for your exercise session

**B. Freely programmable BasicSet** will automatically guide you through your exercise session with the help of the following functions:

- three adjustable target heart rate limits
- three adjustable, alternating timers
- time-based or heart-rate-based recovery calculation

**C. Freely programmable Interval Trainer** will automatically guide you through your interval training session with the help of the following, preset exercise phases:

- warm-up with a target heart rate zone and a countdown timer
- up to 30 intervals with a target heart rate zone. After each interval you have a recovery calculation option.
- cool-down with a target zone and a countdown timer

### 3. FILE

Your receiver stores exercise information in 99 exercise files:

- the start date and time of the exercise
- total exercise time
- the average and maximum heart rate readings for the exercise session
- the recovery value (only BasicSet)
- your heart rate limits used during the exercise
- your time spent in, above and below your target zones during exercise
- OwnCal calorie expenditure
- your cumulative calorie expenditure
- your cumulative exercise time
- your interval training information: warm-up, interval and cool-down phases
- your lap information: best lap time; lap and split times; and current, average and maximum heart rate for each lap
- your heart rate samples recorded in the set recording rate

In addition to exercise file, your cumulative calories and exercise time are updated to your records file.

#### 4. OPTIONS

In the Options mode, you can enter the following settings:

**Exercise Settings:** You can select BasicUse with no settings or 5 freely programmable BasicSets or Interval Training Sets

**Memory Settings:** Set the recording rate of your heart rate of 5 seconds, 15 seconds or 1 minute

**Function settings:** OwnCal calorie counter on/off, fitness test on/off, predicted maximum heart rate on/off

**User-specific Information:** weight, height, date of birth, gender, activity level, maximum heart rate and maximal oxygen uptake

**Monitor Settings:** activity/button sound on/off, measurement units, Help on/off

**Watch Settings:** alarm, time of day, date, reminders on/off



## 5. FITNESS TEST

In this mode you can:

- perform the Polar Fitness Test
- recall your latest test results; OwnIndex and  $HR_{max}$ -p values
- update your user information to reflect your most recent OwnIndex and  $HR_{max}$ -p values

## 6. CONNECTION

In this mode you can:

- upload your receiver settings from your computer to receiver with Polar Precision Performance version 3 or later
- download recorded exercise information to your computer for detailed analysis with Polar Precision Performance version 3 or later

## B. HOW TO ENTER SETTINGS



This section describes how to manually enter settings by pressing the receiver buttons. However, heart rate monitor offers you a faster way as well: prepare your settings with Polar Precision Performance software and upload them to your receiver from your computer. See chapter “Uploading settings from computer”.

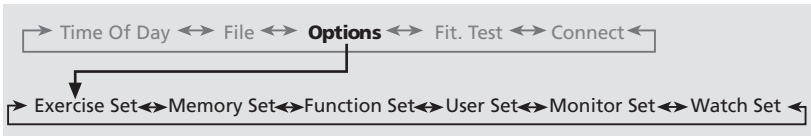

1. In the Time of Day display, scroll up or down until **OPTIONS** is displayed.
  2. Press OK to enter the Options mode. **EXERCISE SET** is displayed.
  3. Scroll up or down until the desired setting mode is displayed.
  4. Press OK to start the settings.
- Move forward and backward by using the up or down buttons.
  - Press OK to start adjusting the value.
  - Scroll up or down to adjust the value.
  - Press OK to lock in your selection.
  - Move backward to the previous setting level by pressing the stop button.
  - To return to the Time of Day display, wherever you are in the Options settings: Press and hold the stop button.
  - The digits run faster if you press and hold the up or down button as you adjust the value. Release the button when approaching the desired value.
  - On the display each function is presented by an abbreviated text. A flashing block on the display indicates how far you are in the setting mode.

## User Information Settings

### Options

User Set

kg/ lbs → cm/ feet inch → Birthday → Sex → Activity → HR<sub>max</sub> → VO<sub>2max</sub>

! In the User Set loop you can move forward only by pressing OK.

Measuring units depend on your choice in Options/ Monitor Set/ Unit 1 or Unit 2.

	Units 1	Units 2
Weight	kg	lbs
Height	cm	ft/ inch
Date of Birth setting order	day - month - year	month - day - year

1. In the Time of Day display scroll up or down until OPTIONS is displayed.
2. Press OK to enter the Options mode. EXERCISE SET is displayed.
3. Scroll up or down until USER SET is displayed.
4. Press OK to start the user information settings.

### Weight (lbs or kg)

5. Scroll up or down to adjust your weight. Press OK.

### Height (ft/ inch or cm)

6. Scroll up or down to adjust your height. Press OK.

Press and hold signal/light button to change the units for weight or height.

### **Date of Birth** (Birthday)

7. Scroll up or down to select your month / day of birth. Press OK.
8. Day / Month appears. Scroll up or down to select the day / month. Press OK.
9. Year appears. Scroll up or down to adjust the year of birth. Press OK.

Units 1: setting order  
is day - month - year.

Units 2: setting order  
is month - day - year.

### **Sex**

10. Scroll up or down to select your gender. Press OK.

### **Activity Level** (Activity)

11. Scroll up or down to select your activity level for Polar Fitness Test. Press OK.

Assess your long-term physical activity level. Do not change your activity level description if your regular exercise habits have changed during the last six months.

- Low** You do not participate regularly in programmed recreational sport or heavy physical activity. Ex. you walk only for pleasure or occasionally exercise sufficiently to cause heavy breathing or perspiration.
- Middle** You participate regularly in recreational sports. Ex. you run 3-6 miles / 5-10 km per week or spend 1/2-2 hours per week in comparable physical activity or, your work requires modest physical activity.
- High** You participate regularly, at least 3 times a week, in heavy physical exercise. Ex. you run 6-12 miles / 10-20 km per week or spend 2-3 hours per week in comparable physical activity.

Download from [www.Somahuals.com](http://www.Somahuals.com). All Manuals Search And Download.

- Top You participate regularly in heavy physical exercise at least 5 times a week.  
Ex. you exercise to improve performance for competitive purposes.

### **Maximum Heart Rate Value** ( $HR_{max}$ )

12. Your age-predicted maximum heart rate value is displayed as a default setting when you set this value for the first time. **If you know your exact clinically tested current maximum heart rate value**, set the value by scrolling up or down.
13. Press OK.

If you do not know this value, update it in the Fitness Test mode after having carried out the Polar Fitness Test.

### **Maximal Oxygen Uptake Value** ( $VO_{2max}$ )

14. The wrist receiver suggests value 35 for females and value 45 for males as a default setting when you set this value for the first time. **If you know your exact clinically tested current maximal oxygen uptake value**, set the value by scrolling up or down.
15. Press OK. USER SET appears.

If you do not know this value, update it in the Fitness Test mode after having carried out the Polar Fitness Test.

To continue your settings, press the stop button. To return to the Time of Day display, press and hold the stop button.

## Exercise Settings

When you start setting your exercise preferences your first choice is to select whether you want to set your personal exercise set or to exercise with BasicUse option. If you select to start setting the exercise sets, your second choice is whether you want to select BasicSet or an Interval Training Set.

### Selecting Exercise Type

#### **BasicUse (E0)**

BasicUse is a simple mode for exercising. You do not have to do any settings before exercising with this Exercise mode. While exercising, you can see the following optional values on the display:

- current heart rate or average heart rate of the exercise
- stopwatch
- time of day
- split- and lap times

Additionally, you can follow calories of your exercise session and percentage of your maximum heart rate, if you have set all the user information and turned the functions

#### **Exercise Set (E1-E5)**

During exercising with this mode you can see the same optional values as in the BasicUse mode. Additionally, the exercise set will guide you through your exercise according to the settings you have made. You can also name the exercise sets Ex. after an exercise type.

You can set following exercise guiding functions:

- 3 heart rate limits
- 3 countdown timers
- interval function
- recovery calculation

## Setting Exercise Sets

Preset exercise sets ready for five exercise sets; when you start exercising, just select one of the sets.

### Interval Training Set



If you choose interval on, you can set 3 different exercise phases for each exercise set in following order:

Warm-up phase

- countdown timer 1 On/OFF
- heart rate limits 1 On/OFF

Interval phase

- interval calculation type: manual, time- or heart-rate-based interval
- number of repeated interval phases
- heart rate limits 2 On/OFF
- time- or heart-rate-based recovery calculation On/OFF

Cool-down phase

- countdown timer 3 On/OFF
- heart rate limits 3 On/OFF

If you set the countdown timers of the phase off, you have to manually stop the phase.

### BasicSet

If you choose interval off, you can set the following functions to your exercise:

- timer 1 On/OFF
- timer 2 On/OFF
- timer 3 On/OFF
- heart rate limits 1 On/OFF
- heart rate limits 2 On/OFF
- heart rate limits 3 On/OFF
- recovery calculation On/OFF



You should select the timers on sequentially. Ex. you cannot set timer 2 on if timer 1 is off.



1. In the Time of Day display scroll up or down until OPTIONS is displayed.
2. Press OK to enter the Options mode. EXERCISE SET is displayed.
3. Press OK to start the exercise settings. BasicUse E0 or exercise set E1-E5 is displayed.
4. Scroll up or down until the desired exercise type is displayed. Press OK.

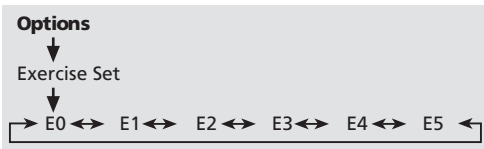

If you chose BasicUse (E0): to return to the Time of Day display, press and hold the stop button and skip the rest of the exercise settings.

If you chose exercise set (E1-E5) Interval On/OFF is displayed.

5. Scroll up or down to turn the interval function on or off. Press OK. Timer 1 is displayed.

### Exercise Set 1 - 5

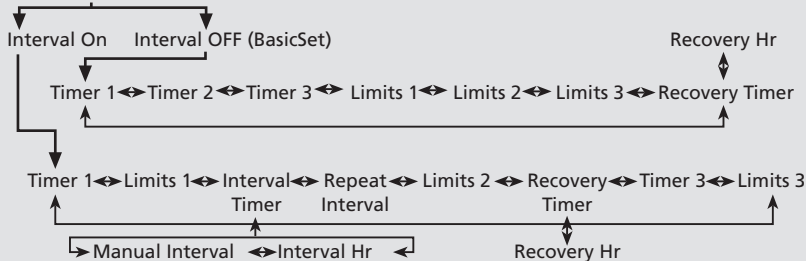

## **Setting Timers**

*If you start from Time of Day display, repeat steps 1-5.*

6. Scroll up or down until desired timer is displayed. Press OK to start setting the timer.
7. Scroll up or down to turn the timer on or off. Press OK.  
Timer OFF: skip steps 8-9.
8. Scroll up or down to adjust minutes. Press OK.
9. Scroll up or down to adjust seconds. Press OK.

## **Setting Heart Rate Limits**

*If you start from Time of Day display, repeat steps 1-5.*

6. Scroll up or down until desired Limits is displayed.
7. Press OK to start setting the limits.
8. Lim High appears. Scroll up or down to adjust your upper limit. Press OK.
9. Lim Low appears. Scroll up or down to adjust your lower limit. Press OK.

## **Turning Heart Rate Limits on/off**

*If you start from Time of Day display, repeat steps 1-5.*

6. Scroll up or down until desired Limits is displayed.
7. Press and hold the signal/light button to turn limits on or off. Release.

## Setting Interval Type

You can select 3 optional types of intervals:

**A. Time-based interval**

Ends your interval when you have used the selected time.

**B. Heart-rate-based interval**

Ends your interval as you reach the selected heart rate.



When selecting heart-rate-based interval, recovery calculation must be set on.

**C. Manual interval**

End the interval training session by pressing and holding OK.

*If you start from Time of Day display, repeat steps 1-5.*

6. Scroll up or down until Interval TIMER/ Hr/ MANUAL is displayed. Press OK to start setting the interval type. TIMER/ Hr/ MANUAL is flashing.
7. Scroll up or down to select the interval type that will be used to end the interval. Press OK. If you chose manual interval skip steps 8 - 9.

**A. Time-based interval**

**Or B. Heart-rate-based interval**

8. Scroll up or down to adjust minutes. Press OK.
9. Scroll up or down to adjust seconds. Press OK.  
Interval TIMER appears.

8. Scroll up or down to adjust the heart rate that will end your interval. Press OK.  
Interval Hr appears.

## **Setting the Number of Intervals and Recoveries (Repeat)**

*If you start from Time of Day display, repeat steps 1-5.*

You can set up to 30 intervals and recoveries (if set on) for an interval phase.

6. Scroll up or down until Repeat is displayed.
7. Press OK to start setting the number.
8. Scroll up or down to adjust the number. Press OK.

### **Or**

If you do not know in advance the number of intervals and recoveries select continuous interval. The intervals will succeed until you manually stop the exercise or until 30 intervals have been made.

8. Scroll down until Cont  appears. Press OK.

## **Setting Recovery Calculation**

- |                                     |  |
|-------------------------------------|--|
| <b>A.</b> Time-based recovery       | Ends your recovery as you reach the preset time.       |
| <b>B.</b> Heart-rate-based recovery | Ends your recovery as you reach the preset heart rate. |

*If you start from Time of Day display, repeat steps 1-5.*

6. Scroll up or down until Recovery TIMER/ Hr is displayed.
7. Press OK to start setting recovery calculation on or off. On/OFF is flashing.
8. Scroll up or down to turn the recovery calculation on or off. Press OK.  
OFF: skip steps 9-11.  
On: TIMER/ Hr is flashing.
9. Scroll up or down to select recovery timer or heart rate. Press OK.

**A.** RecoTime is displayed.

10. Scroll up or down to adjust minutes. Press OK.

11. Scroll up or down to adjust seconds. Press OK.

Recovery TIMER appears.

**B.** RecoHr is displayed.

10. Scroll up or down to adjust the value. Press OK.

Recovery Hr appears.

To continue your settings, press the stop button. To return to the Time of Day display, press and hold the stop button.

### **Naming Exercise Sets**

You can name the exercises, with seven letters, numbers or punctual marks. The available digits are: 0-9, space, A-Z, a-z, - % / ( ) \* + : ?.

1. In the Time of Day display scroll up or down until OPTIONS is displayed.

2. Press OK to enter the Options mode. EXERCISE SET is displayed.

3. Press OK. E0-E5 is displayed.

4. Scroll up or down until desired exercise set (E1-E5) is displayed.

5. Press and hold signal/light button. Adjustable letter is flashing.

6. Scroll up or down to select the desired mark. Press OK.

7. Repeat previous step until you have chosen all 7 letters.

To continue your settings, press the stop button. To return to the Time of Day display, press and hold the stop button.

## Setting Recording Rate

You can program your receiver to record data in 5, 15 or 60 seconds intervals.

1. In the Time of Day display scroll up or down until OPTIONS is displayed.
2. Press OK to enter the Options mode. EXERCISE SET is displayed.
3. Scroll up or down until MEMORY SET is displayed.
4. Press OK to start the memory settings. Rec. Rate is displayed.
5. Scroll up or down to select the desired recording rate. As you change the recording rate you can see the memory there is left in the lower row. Press OK.

Options



Memory Set



Rec. Rate 5 Sec / 15 Sec / 60 Sec

The recording time of the receiver depends on the selected recording rate (5 s, 15 s, or 60 s). When the memory is full, you can continue exercising but the exercise is no longer recorded. The following table shows the maximum exercise times for each recording rate.

<b>Recording rate</b>	<b>Maximum exercising time</b>
5 s	22 h 03 min
15 s	66 h 10 min
60 s	99 h 59 min one file and total 260h

To continue your settings, press the stop button. To return to the Time of Day display, press and hold the stop button.

## Turning Functions on/off

1. In the Time of Day display scroll up or down until OPTIONS is displayed.
2. Press OK to enter the Options mode. EXERCISE SET is displayed.
3. Scroll up or down until FUNCTION SET is displayed.
4. Press OK to start the function settings. OwnCal is displayed.

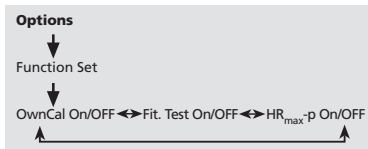

- ! To set the following functions on you have to set your user information. If kg/lbs are displayed as you start setting the function on, the wrist receiver points out that you have not set your all user information.

### OwnCal Calorie Counter on/off

*If you start from Time of Day display, repeat steps 1-4.*

5. Press OK to start setting the OwnCal function. On/OFF starts to flash.
6. Scroll up or down to set the OwnCal on or off. Press OK.

To get the most accurate OwnCal results, update the  $VO_{2max}$  setting and the  $HR_{max}$  setting with clinically measured values (if available). If you do not know your clinically measured values perform Polar Fitness Test and update the OwnIndex and  $HR_{max-p}$  settings in Fitness Test mode.

### Fitness Test on/off

*If you start from Time of Day display, repeat steps 1-4.*

5. Scroll up or down until Fit. Test is displayed.
6. Press OK to start setting the Fitness Test. On/OFF starts to flash.
7. Scroll up or down to set the Fitness Test on or off. Press OK.

## Predicted Maximum Heart Rate on/off (HR<sub>max</sub>-p)

If you start from Time of Day display, repeat steps 1-4.

5. Scroll up or down until HRmax-p is displayed.
6. Press OK to start setting the HR<sub>max</sub>-p. On/OFF starts to flash.
7. Scroll up or down to set the HR<sub>max</sub>-p on or off. Press OK.

HR<sub>max</sub>-p can be turned on only if Polar Fitness Test is on.

To continue your settings, press the stop button. To return to the Time of Day display, press and hold the stop button.

## Monitor Settings

1. In the Time of Day display scroll up or down until OPTIONS is displayed.
2. Press OK to enter the Options mode. EXERCISE SET is displayed.
3. Scroll up or down until MONITOR SET is displayed.
4. Press OK to start the monitor settings. Sound is displayed.

### Options

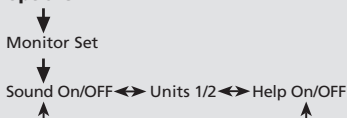

## Turning Activity/Button Sound on/off

If you start from Time of Day display, repeat steps 1-4.

5. Press OK to start setting the sound. On/OFF starts to flash.
6. Scroll up or down to set sound on or off. Press OK.

Your receiver has two distinct sounds: activity/button sound and alarms for heart rate zones, watch and fitness test. This setting includes only the activity/button sound settings.



Certain Measure and Exercise mode settings will be audible: start, stop, interval phase start and end and recovery calculation end.

### **Selecting Measuring Units**

*If you start from Time of Day display, repeat steps 1-4.*

5. Scroll up or down until Units is displayed.
6. Press OK to start setting the units. 1 or 2 starts to flash.
7. Scroll up or down to select the unit which best suits you. Press OK.

The units settings affect the units in the user information settings and the order of your date of birth settings.

**Units 1:** kg, cm, day-month-year      **Units 2:** lbs, feet, month-day-year

### **Turning Help on/off**

*If you start from Time of Day display, repeat steps 1-4.*

5. Scroll up or down until Help is displayed.
6. Press OK to start setting the Help function. On/OFF starts to flash.
7. Scroll up or down to set the Help on or off. Press OK.

If you turn Help on, the flashing arrows guide you to use the correct buttons in the Options and File modes. If you want to change the middle row information during exercise, the function name will appear for a few seconds.

To continue your settings, press the stop button. To return to the Time of Day display, press and hold the stop button.

Download from [Www.Somanuals.com](http://www.Somanuals.com). All Manuals Search And Download.

## Watch Settings

1. In the Time of Day display scroll up or down until OPTIONS is displayed.
2. Press OK to enter the Options mode. EXERCISE SET is displayed.
3. Scroll up or down until WATCH SET is displayed.
4. Press OK to start the watch settings. ALARM is displayed.

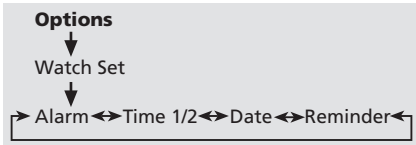

### Setting Alarm

*If you start from Time of Day display, repeat steps 1-4.*

5. Press OK to start alarm settings.
    - )) On/OFF starts to flash.
  6. Scroll up or down to set alarm on or off. Press OK. 24h: skip step 7.
  7. 12h: AM/PM starts to flash. Scroll up or down to select AM or PM. Press OK.
  8. The hours start to flash. Scroll up or down to adjust the hours. Press OK.
  9. The minutes start to flash. Scroll up or down to adjust the minutes. Press OK.
- When the alarm comes on, it will sound for one minute. You can turn it off by pressing any of the buttons.

OFF: skip  
steps 7-9.

### Setting Time of Day

*If you start from Time of Day display, repeat steps 1-4.*

5. Scroll up or down until TIME1/ TIME2 is displayed.
6. Press OK to start setting the time of day.
7. Time is flashing. Scroll up or down to select time 1 or time 2. Press OK.

- 12h/ 24h starts to flash. Scroll up or down to select 12h or 24h time mode. Press OK. 24h: skip step 9.
- AM/ PM starts to flash. Scroll up or down to select AM or PM. Press OK.
- The hours start to flash. Scroll up or down to adjust the hours. Press OK.
- The minutes start to flash. Scroll up or down to adjust the minutes. Press OK.

## Setting Date

*If you start from Time of Day display, repeat steps 1-4.*

The date is displayed differently depending on whether you have set 12h or 24h time mode.

**12h time:** month-day-year    **24h time:** day-month-year

- Scroll up or down until DATE is displayed.
- Press OK to start adjusting the date.
- Month / Day appears. Scroll up or down to select the desired value. Press OK.
- Day / Month appears. Scroll up or down to select the desired value. Press OK.
- Year digits start to flash. Scroll up or down to select the year. Press OK.

12h Time mode:  
month - day - year.  
24h Time mode:  
day - month - year.

## Turning Reminders on/off

*If you start from Time of Day display, repeat steps 1-4.*

- Scroll up or down until REMIND is displayed.
- Press OK to start setting the reminders.
- Scroll up or down until desired reminder is displayed. The number of the reminder is displayed in the corner of the display.
- Press OK. On/OFF starts to flash.
- Scroll up or down to set the reminder on or off. Press OK.

You can upload 7 reminders, each including time and name, to your wrist receiver from Polar Precision Performance software.

The reminder sounds an alarm only when time of day is displayed. When the reminder alarm comes on, it will sound for 15 seconds or you can turn it off by pressing any of the buttons except the signal/light button. Erase the reminder text by pressing any of the buttons except the signal/light button.

To continue your settings, press the stop button. To return to the Time of Day display, press and hold the stop button.

## Setting Tips

### Swap Time 1 or Time 2

In the Time of Day display press and hold the down button. Time 1 or Time 2 is displayed in the uppermost row for a couple of seconds. Displayed time will now be used in all watch and alarm functions. If you chose time 2, "2" is displayed in the Time of Day display.

### Shortcut to Watch Setting Loop

Press and hold the signal/light button for a few of seconds to enter into the watch setting loop. If you want to skip some parts and go directly to a watch function, scroll up or down until the desired watch function is displayed. Set the function as in the "Watch settings" section.

**Swap Measuring Units** as you set your user information on weight and height. Press and hold the signal/light button until the units are swapped. Release the button.

### Swap Date, User ID Number, User Name and Logo

You are able to set a user ID number, user name and logo by Polar Precision Performance software. These settings are shown on the upper row of the Time of Day display. You can swap between the user ID, user name, logo and date.

# C. EXERCISE

## Time of Day



Heart Rate Measure Mode



Exercise Recording Mode

You can use two modes in your exercise: **Measure or Exercise mode.** In the **Measure mode** you can see your heart rate but your exercise is not recorded. In the **Exercise mode** your exercise is recorded and stopwatch and other calculations are started.

## Heart Rate Measure Mode

1. Wear the transmitter and the wrist receiver as described in "Easy start" section.
2. To make sure that the code search will be successful:
  - Keep the wrist receiver within 3 feet/ 1 meter of your transmitter.
  - Check that you are not near: people with heart rate monitors, high voltage power lines, televisions, mobile phones, cars, motor driven exercise equipment or other electromagnetic disturbance.

3. Start from Time of Day display by pressing the OK to start measuring your heart rate. A heart symbol will start flashing and your heart rate in beats per minute will appear in max. 15 seconds. The frame around the heart symbol indicates that the heart rate reception is coded. You have now entered to the Measure mode.

The following displays start to alternate as you enter the Measure mode:

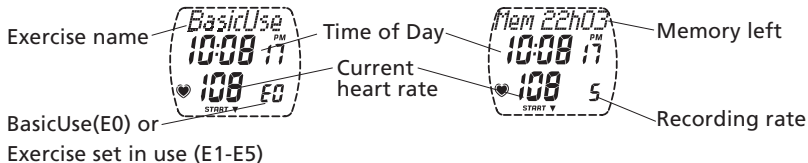

The receiver returns automatically to the Time of Day display within 5 minutes if there is no heart rate reception.

## Exercise Recording Mode

*If you are continuing from Measure mode, press OK.*

*Or, if you are starting from Time of Day display, press and hold OK.*

Exercise information will be stored in an exercise file only when the stopwatch is running. The ongoing recording is indicated with a graphic bar that runs continuously on the display.

**If there is 00 / - - reading** on the display, there is no heart rate reception. Bring the wrist receiver up to your chest near the transmitter's Polar logo. The receiver starts looking for the heart rate signal again.



At the start of your workout, the exercise time is displayed in minutes and seconds. When you have exercised more than 60 minutes, the exercise time is displayed in hours and minutes.

### **Turning the Heart Rate Zone Alarm on/off**

Press and hold the signal/light button.

When «))» appears on the display the zone alarm is on. You will hear a beeping sound with each heartbeat if your heartbeat is outside the heart rate limit. If you do not want to use the zone alarm the flashing heart rate reading indicates if your heartbeat is outside the heart rate limit. This function can be used if you have set heart rate limits on in Interval Training Set or BasicSet.

In addition to the rate zone alarm you can see:

- ▲ if you are exercising above heart rate zone.
- ▼ if you are exercising below heart rate zone.

### **Swapping the Heart Rate Limits**

Press and hold the up button. Repeat until the desired limits are displayed. In the Interval Training mode the limits are automatically swapped when the phase changes to the preset limits.

### **You have three optional Exercise modes depending on the selected exercise:**

- BasicUse
- Interval Training Set (Int On)
- BasicSet (Int OFF)

The following functions can be used during all three optional Exercise modes.

### **Illuminating the Display**

Press the signal/light button.

After you use backlight once in the Measure mode, the receiver automatically illuminates the display if you: start or stop the exercise session, store lap information and at the end of an interval and a recovery calculation.



## Storing Lap and Split Time

Press OK to store lap and split time.

*First*

Lap time  
Average heart  
rate of the lap  
Number of  
the lap



*Then*

Split time



The receiver automatically stores a lap time when you stop recording an exercise. You can store 99 laps if you have not used the interval function. After storing 99 laps FULL appears for a few seconds every time you take a lap. You can continue taking laps but they will not be stored. The wrist receiver continues recording all other information of the exercise, except lap and interval information.

## Pausing the Exercise

Press the stop button.

The exercise recording, stopwatch and other calculations are paused. To continue them, press OK. Or, to return to the Time of Day display, press and hold the stop button.



The receiver automatically returns to the Time of Day display within 5 minutes if you forget to quit the heart rate measuring after having stopped the stopwatch and taken the transmitter off your chest.

Download from [www.Somanuals.com](http://www.Somanuals.com). All Manuals Search And Download.

## Swapping the Displayed Exercise Information

There are three display options, which you can swap between by pressing the down button. The receiver saves the upper and lower row settings for the three display options. If the Help function is on, the name of the displayed function appears for a few seconds. When you start the exercise next time the stopwatch appears on the middle row and the saved functions appear on the upper and lower rows.

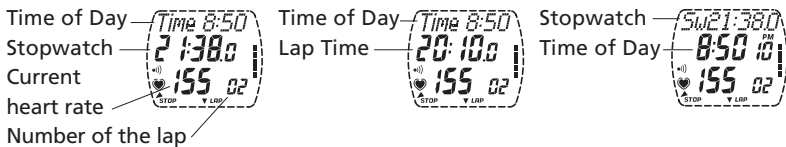

! When you have set your Interval Training Set on, you will have one extra display in addition to the three primary displays. You can only change lower row for this display. See the alternative phase displays from "Exercising with Interval Training Set" section.

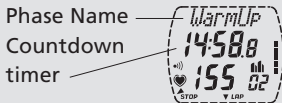

 You can configure the middle and upper rows either in the Measure mode or during the exercise.

### **Select the Middle Row Information**

1. Press the down button to select the desired display alternative. When you swap the middle row information, the upper and lower rows change also. Continue selecting the upper and lower rows.

### **Select the Upper Row Information**

2. Press the up button to select from the following: Time of Day (Time), stopwatch (Sw), lap time (Lp) or calorie expenditure (Cal) if OwnCal is set on.

You cannot select the same displayed function to the upper and middle row i.e. the option on the middle row is no longer available for the upper row.

### **Select the Lower Heart Rate Information Row**

3. Press and hold the down button to select from the following: Current heart rate, average heart rate (AVG) or the reading in percentages of your maximum heart rate (% MAX) if you have set your user information.

You can only change the displayed function of the lower row if the stopwatch is on.

### **Resetting the Stopwatch to Zero**

As a result of resetting your stopwatch the recorded file is deleted.

1. Press the stop button to pause your exercise.
2. Press and hold the down button until the stopwatch is reset. Release.
3. Press OK to restart the stopwatch and recording. Or, to return to the Time of Day display, press and hold the stop button.

Download from [www.Somanuals.com](http://www.Somanuals.com). All Manuals Search And Download.

## Starting an Exercise Set

1. Start from the Time of Day display. Press OK to enter the Measure mode.
2. If you want to swap the preset exercise set, press and hold the up button until the exercise set (E1-E5) is swapped. Release. Repeat until desired exercise set is displayed.
3. To start exercising and recording the preset exercise type press OK.

## Exercising with Interval Training Set (Int On, E1-E5)

In this mode you can also use the functions in "Exercise Recording Mode" section.

The Interval Trainer automatically guides you through your exercise. In order to hear the activity sounds when the phase starts and stops make sure the activity/button sound is on. If you have turned the countdown timer of the phase off, you have to stop the phase manually by pressing and holding the OK button. When the stopwatch starts running  indicates that Interval Trainer is on. As the interval training exercise ends the receiver automatically starts a BasicUse exercise, which is recorded to the same file as your interval training exercise.

## Structure of an interval training exercise:

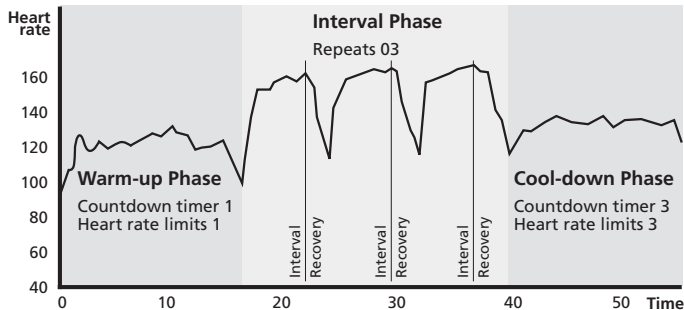

### Warm-up Phase



#### 1. First

Heart rate limits 1 (if set on).



#### 2. Then

Countdown timer 1.

Heart rate information.

Countdown timer starts running if you have set the timer 1 on. If you have set the timer off, press and hold OK and continue from the interval phase.



#### 3. At the end of warm-up phase

Warm-up phase duration.

Average heart rate of the warm-up phase.

## Interval Phase

The receiver records up to 30 repeated interval phases. Your interval phase is divided into interval and recovery calculation (if set on) sections, which alternate continuously through your interval phase.

### Interval Session



1. *First*

Preset heart rate limits 2 (if set on).

2. *Then*

One of the following is displayed depending on your settings:

**A.** manual, **B.** time-based or **C.** heart-rate-based interval.



**A.** Manual interval

Number of set intervals.

Current interval number.

If you selected manual interval your interval will end as you press and hold OK.

**Or**

**B.** Time-based interval

Countdown timer.

If you selected time-based interval your interval will end as you reach the preset time.

**Or**

**C.** Heart-rate-based Interval

The difference between the preset interval heart rate and current heart rate.

If you selected heart-rate-based interval your interval will end as you reach the preset heart rate reading.





3. *At the end of Interval*
- Interval duration.
  - Average heart rate of the interval.

When your interval ends the wrist receiver automatically continues with following preset function: recovery calculation or cool-down phase.

### Recovery Calculation

One of the following is displayed depending on your settings: **A.** time-based recovery calculation or **B.** heart-rate-based recovery calculation.



- A.** Time-based recovery.
- Recovery countdown timer.
  - Current heart rate.

**Or**



- B.** Heart-rate-based recovery.
- The difference between the preset recovery heart rate and current heart rate.
  - Current heart rate.

You will hear two beeps when the recovery calculation is done.



- At the end of recovery*
- Recovery heart rate or time.
  - Recovery duration.
  - Drop in your heart rate.



## Cool-down Phase

### 1. First

Preset heart rate limits 3 (if set on).



### 2. Then

Countdown timer 3.

Heart rate information.

Countdown timer starts running if you have set the timer 3 on. If you have set the timer off press and hold OK to end the cool-down phase.

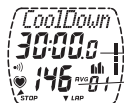

### 3. At the end of cool-down phase

Cool-down phase duration.

Average heart rate of the cool-down phase.



After your cool-down phase has ended the receiver automatically continues recording exercise with BasicUse mode.

You can continue using and swapping the heart rate limits of the previous exercise in this mode too. If you want to do another interval training exercise, press and hold the OK button.



### **Interrupting an Interval Training Exercise**

1. Press the stop button to pause the exercise.
2. Press and hold the stop button to return to the Time of Day display.

#### **Or**

Press the stop button. BasicUse appears. You can continue measuring your heart rate in this mode (Measure mode). To continue exercising with BasicUse and recording your exercise information press OK. You can continue using and swapping the same heart rate limits of the previous exercise. Repeat steps 1 and 2 to return to the Time of Day display.

### **Exercising with BasicSet (Int OFF, E1-E5)**

In this mode you can also use the functions in "Exercise Recording Mode" section.

### **Starting the Timers**

If timers are set on, they automatically start running once you start the stopwatch. Timers alternate in the following order: timer 1, 2, 3, 1, 2, 3, etc. At the end of timer 1 you will hear 1 beep, at the end of timer 2 you will hear 2 beeps and at the end of timer 3 you will hear 3 beeps. Timers stop running when you stop the stopwatch.

## Starting Recovery Calculation

To start the recovery calculation, press and hold the OK button. See “Exercising with Interval Trainer”/ “Recovery calculation” for the displayed information during the recovery calculation. After the recovery calculation is done the exercise is paused. You can continue the exercise by pressing the OK button after the recovery calculation. If you do another recovery calculation, the previous recovery information will be deleted.

## Stopping the Exercise

1. Press the stop button to pause the exercise.
2. Press and hold the stop button until time of day is displayed. Your lap and split time are automatically recorded, when you end the exercise.

## Tips During the Exercise

### Swapping the Recording Rate of the Exercise (5 s, 15 s or 60 s)

In the Measure mode press and hold the down button. Release. Repeat until desired recording rate is displayed.

### Swapping the Exercise Type (E0 or E1-E5)

In the Measure mode press and hold the up button. Release. Repeat until desired exercise set or BasicUse is displayed.

## **Restarting the Interval or Recovery Calculation**

In the Exercise mode press the stop button to pause the interval or recovery calculation. Reset the calculation by pressing and holding the down button. To restart the same calculation press the OK button. To reset the interval training exercise, see "Resetting Stopwatch to Zero" section.

## **Interrupting an Interval or Recovery Calculation**

Press and hold the OK button during your interval training exercise session to interrupt the calculation. The following section automatically starts. Ex. if you interrupt an interval your recovery calculation (if set on) automatically starts.

## **Interrupting a Phase of an Interval Training Exercise**

Press the stop button to pause your phase. Press and hold the OK button. The following phase automatically starts.

## **Heart Touch Function**

The heart touch function is activated as you bring the wrist receiver near the transmitter's Polar logo.

You have three display alternatives for the heart touch function. To select you heart touch display, use your Polar Precision Performance software:

- Checking the current heart rate limits
- Swapping the three or four (if interval on) display options
- Storing lap time

During the heart touch, the backlight is on for a couple of seconds, if you have already used the backlight during the exercise.

Download from [www.Softmanuals.com](http://www.Softmanuals.com). All Manuals Search And Download.

## D. HOW TO RECALL TRAINING INFORMATION



The receiver starts saving exercise information to a file as you start the stopwatch. You can recall the information in the File mode. In the File mode there are up to 99 exercise files and a record file, which keeps track of the cumulative values.

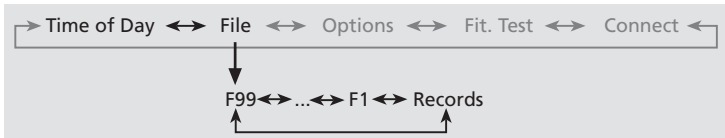

Your first file is F1, then F2 and so on, until you have recorded maximum 99 exercise files. The bigger the file number the more recent it is.

 Some information alternates on the display automatically. You can make the alternation faster by pressing the OK button, Ex. the target heart rate zone information.

### Exercise File

1. In the Time of Day display scroll up or down until FILE is displayed.
2. Press OK to enter the File mode. The main information of your file is displayed.

Starting date and time alternate on the display.

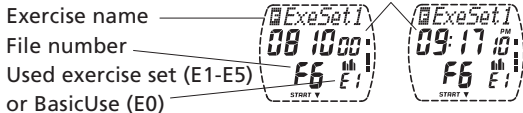

3. Scroll up or down until the desired file is displayed.
4. Press OK to start recalling an exercise file. Exe. Time is displayed.

- Move forward and backward within file loops with up or down buttons.
- Press OK to enter a file or to enter a deeper level in the file loop.
- Press the stop button to move backward to the previous file level.
- Press and hold the stop button to return to the Time of Day display, wherever you are in the File recalling cycle.

### Exercise File (F1-F99)

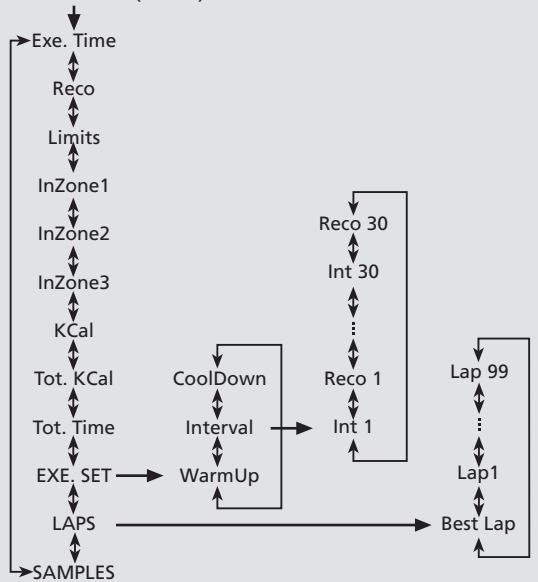



### **Exercise Time (Exe. Time)**

The exercise time is the amount of time that you have exercised with the stopwatch running. Average and maximum heart rates of your exercise alternate on the display. To continue recalling the file, scroll up or down button.



### **Recovery Information of BasicSet Exercise (Reco)**

- Recovery time.
- Recovery duration.
- Drop in your heart rate.

**Or**



- Recovery heart rate.
- Time it took reach the preset heart rate reading.
- Drop in your heart rate.

### **Heart Rate Limits 1, 2 and 3 (Limits 1/ Limits 2/ Limits 3)**

Settings of the heart rate limits alternate on the display. Limits 1 are used for heart rate zone 1, limits 2 for zone 2 and limits 3 for zone 3.

### **Exercise Time within, above and below the Heart Rate Zones**

Indicates the exercise time, which you have spent within (InZone), above and below each heart rate limits during the entire exercise.

### **Calorie Expenditure (KCal)**

You will see how many kilocalories you have expended during the exercise.

### **Cumulative Calorie Count (Tot. KCal)**

Calculates the cumulative calories expended during several exercise sessions starting from the previous value stored in the records file. This function allows you to follow the calorie count as a gauge of effective exercise Ex. during one week.

### **Cumulative Exercise Time Count (Tot. Time)**

This function counts cumulative exercise time expended during several exercise sessions starting from the previous value stored in the records file. It allows you to follow the exercise time count as a gauge of amount of exercise Ex. during one week.



Your cumulative total time is displayed in hours and minutes until 99 hours 59 minutes is reached. After this your cumulative exercise time is displayed in hours until 9999 hours is reached.



## Interval Training Information (EXE. SET)

Start with the display showing EXE. SET.

1. Press OK to start recalling the interval training information.
2. Scroll up or down to see the information on warm-up, interval and cool-down phases.

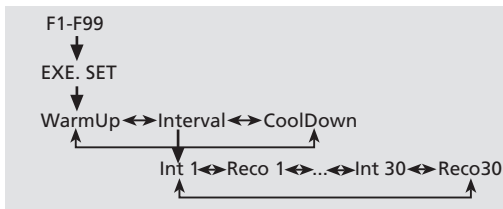

### Warm-up Phase

Warm-up duration.

The heart rate at the end of the warm-up,

average and

maximum heart rates of your warm-up phase.

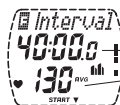

### Interval Phase

Interval phase duration.

Average heart rate of intervals and recoveries.



### Cool-down Phase

Duration of the cool-down.

The heart rate at the end of the cool-down,

average and

maximum heart rates of the cool-down phase.

3. Press the stop button to return to the previous file level and skip steps 4 - 6. Or, continue recalling more detailed information of the interval phase.
4. Start with the display showing Interval. Press OK to see details of each interval and recovery.
5. Scroll up or down between intervals (Int) and recoveries (Reco).

## Interval Information

Interval number

Split time of the interval

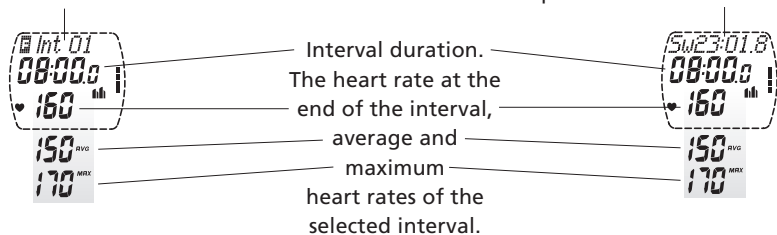

## Recovery Information

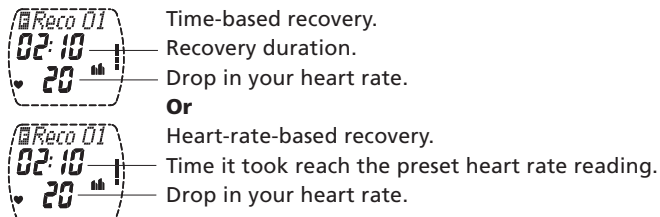

6. To continue recalling, Ex. lap information press the stop button twice.  
Scroll up or down until LAPS is displayed.

### Lap Information (LAPS)

Start with the display showing LAPS and number of the recorded laps.

1. Press OK to start recalling the lap information.
2. Scroll up or down to see the following information:

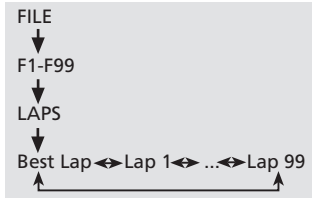

#### Best Lap

Shortest lap time.

The number of the best lap.

The best lap information is displayed if you have stored at least 3 laps. The best lap can not be the last lap.



#### Laps

Split time.

Lap time.

Lap number.

The heart rate at the end of the lap,



average and

maximum heart rates of the lap.

Press the stop button to exit the LAPS display.

## Recorded Heart Rate Samples

Check from the sample file detailed heart rate information of the exercise.

Start with the display showing SAMPLES.

1. Press OK to start recalling the recorded samples of your exercise information. The heart rate and time when the heart rate sample was recorded are displayed.
2. Scroll up or down the samples.  
Press and hold stop to return to the Time of Day display.

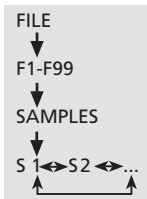

## Records File (cumulative values)

This file is updated as your exercise is recorded to file.

1. In the Time of Day display scroll up or down until FILE is displayed.
2. Press OK to enter the File mode.
3. Scroll up or down until Records is displayed.
4. Press OK to enter the records file. Tot. KCal is displayed.  
You will have a count for cumulative calories expended during several exercise sessions.
5. Scroll up or down to see the cumulative exercise time (Tot. Time)  
You can now return to the Time of Day display by pressing and holding the stop button or continue resetting your cumulative counts.

## Resetting Your Cumulative Counts to Zero

Once you have reset the cumulative count you cannot retrieve it.

Start with the display showing Tot. KCal or Tot. Time in the records file.

1. Press OK to start resetting the desired total count. Reset appears and the value starts to flash.

2. Press and hold the down button. Reset starts to flash. You can still cancel the resetting by releasing the down button before the value is reset. If you are sure that you want to reset the value keep holding the down button until value is reset. Release.
3. Press the stop button to exit the reset display. Press and hold the stop button to return to the Time of Day display.

### **Deleting a File**

1. In the Time of Day display scroll up or down until FILE is displayed.
2. Press OK to enter the File mode.
3. Scroll up or down until desired exercise file is displayed. Press and hold the signal/light button. DELETE FILE and file number are displayed.
4. Press OK. The receiver confirms if you want to delete a file (Are you sure).
5. Press OK to delete the selected file.
6. Press stop to exit the file. Wait appears. The receiver reorganizes your file, which takes few seconds.
7. Repress stop to return to the Time of Day display.

### **Deleting All Files**

1. In the Time of Day display scroll up or down until FILE is displayed.
2. Press and hold the signal/light button. DELETE FILES is displayed.
3. Press OK. The receiver confirms if you want to delete all files (Are you sure).
4. Press OK to delete all exercise files.
5. Press stop to return to the Time of Day display.

# E. CONNECTION TO COMPUTER



There is two-way communication between Polar heart rate monitor and a computer. Polar Precision Performance software offers an easy way to analyse training data. A training log makes it possible to plan future training. Wrist receiver settings are easy to upload from the software instead of entering them manually.

After preparing your settings you can upload options lock function. Your options can no longer be changed until you deactivate the options lock from the “user features” of your software.

## Downloading Training Data to a Computer

! For IR communication you need an IrDA port and Windows® 98 operating system or later in your computer.

If you do not have an IrDA port in your computer you need one of the following:

- A) an optional Polar IR Interface for RS 232 port and Windows® 95 operating system or later in your computer

Download from [www.Somanuals.com](http://www.Somanuals.com). All Manuals Search And Download.

**or**

- B) an optional Polar IR Interface for USB port and Windows® 98 operating system or later in your computer.

Install the Polar Precision software (version 3 or later) first, then connect the optional Interface to the corresponding port of the computer before starting the software.

1. Start the Polar Precision Performance software.
2. Scroll up or down until CONNECT is displayed in the receiver display. Point the infrared window of the receiver towards the infrared window of the computer or an optional Interface. The maximum infrared transfer distance is 20 cm/ 8" and the infrared transfer angle  $\pm 15$  degrees.
3. On the toolbar of the software, click on the heart rate monitor Connection icon  and hold the receiver steady. A new window "Infrared Connection" appears.
4. The receiver automatically starts to communicate with the software as Infrared appears. Follow the instructions on the computer screen to proceed with downloading exercise files or uploading heart rate monitor settings.

## Uploading Settings from Computer

Your heart rate monitor offers you the option of preparing your settings with Polar Precision Performance software. You are also able to set following functions with the software:

- a user ID, user name or logo for easier receiver recognition in multiple receivers.

Download from [www.Somanuals.com](http://www.Somanuals.com). All Manuals Search And Download.

- the heart touch function to show the current heart rate limits, store a lap time or swap the display options during your exercise
- names and alarm times for 7 reminders
- options lock function on or off

You may upload settings from a computer to a wrist receiver either via IR communication or via audible Polar Uplink. For IR communication please see the previous chapter and for the Polar Uplink communication proceed as follows:

1. Start the software.
2. If the receiver is in the Time of Day display scroll up or down until CONNECT is displayed.
3. Place the receiver less than 4" / 10 cm from the loudspeaker.
4. Activate the upload function of the software. Do not move the receiver during the data transfer.
5. The receiver automatically starts to upload the information as UpLink appears. You will hear a chirping sound while information is transferred to the receiver. The receiver automatically returns to the Time of Day display after data transfer.

**If the data transfer was unsuccessful** bring the receiver closer to the loudspeakers or turn the volume level of the loudspeakers up.

! To be able to upload the settings from Polar Precision Performance software via Polar Uplink, you need a personal computer with a sound card (compatible with SoundBlaster™) and dynamic loudspeakers or headphones.



# F. POLAR FITNESS TEST



The Polar Fitness Test is an easy, safe and quick way to estimate individual maximal aerobic power and to get predicted maximum heart rate value. The Polar Fitness Test is targeted to healthy adults.

## OwnIndex

OwnIndex is a value which is comparable to maximal oxygen uptake ( $VO_{2max}$ ), a commonly used descriptor of aerobic fitness. Cardiovascular (aerobic) fitness relates to how well your cardiovascular system works to transport and utilize oxygen in your body. The stronger and more efficient your heart is, the better the cardiovascular fitness is.  $VO_{2max}$  is a good indicator of performance in endurance sports.

If you want to improve your cardiovascular fitness, it takes a minimum of 6 weeks on an average to see a noticeable change in OwnIndex. Less fit individuals see progress even more rapidly and for more fit individuals more time is needed. The better the cardiovascular fitness of an individual, the smaller the improvements in OwnIndex.

Cardiovascular fitness is best improved by exercise types which employ large muscle groups. Such activities include cycling, running, swimming, rowing, skating, cross-country skiing and walking.

To monitor your fitness progress start with measuring your OwnIndex a few times during the first two weeks, to get a baseline value. Thereafter, repeat the test approximately once a month. OwnIndex is based on resting heart rate, heart rate variability at rest, age, gender, height, body weight and self-assessed physical activity.

## Predicted Maximum Heart Rate ( $HR_{\max-p}$ )

The  $HR_{\max-p}$  definition is carried out simultaneously with the Polar Fitness Test.

The  $HR_{\max-p}$  score predicts your individual maximum heart rate value more accurately than the age-based formula ( $220-\text{age}$ ). The age-based method provides a rough estimation and may not be very accurate, especially for people who have been fit for many years or for older people. The most accurate way of determining your individual maximum heart rate is to have it clinically measured (in maximal treadmill or bicycle stress test) by a cardiologist or an exercise physiologist.

Your maximum heart rate changes to some extent in relation to your fitness. Regular endurance exercise tends to decrease  $HR_{\max}$ . There may also be some variation according to the sport you participate in. For example, running  $HR_{\max} >$  cycling  $HR_{\max} >$  swimming  $HR_{\max}$ .

$HR_{\max-p}$  gives the possibility of defining training intensities as percentages of maximum heart rate and of following maximum heart rate changes due to training, without an exhaustive maximal stress test.  $HR_{\max-p}$  is based on resting heart rate, heart rate variability at rest, age, gender, height, body weight and maximal oxygen uptake,  $VO_{2\max}$  (measured or predicted). The most accurate  $HR_{\max-p}$  is obtained by entering your clinically measured  $VO_{2\max}$  into the wrist receiver.

## Fitness Test Settings

To be able to carry out the Polar Fitness Test you need to do the following settings in the Options mode:

- Set your personal user information and long-term physical activity level.
- Set the Polar Fitness Test on.
- Set the HR<sub>max</sub>-p on if you want to get a prediction of your maximum heart rate.

## Carrying Out the Test

To get reliable test results, the following basic requirements apply:

- You should be relaxed and calm.
- The test can take place anywhere – home, office, health club – as long as the testing environment is peaceful. No disturbing noises (Ex. television, radio or telephone), no other people talking to you.
- Keep the testing place, time of day and environment the same every time the test is repeated.
- Avoid eating a heavy meal or smoking 2-3 hours prior to testing.
- Avoid heavy physical effort, alcoholic beverages or pharmacological stimulants on the test day and the day before.

1. In the Time of Day display scroll up or down until FIT. TEST is displayed. If you cannot find Fitness Test mode check that you have turned the function on in the Options mode.
2. Press OK to enter the Fitness Test mode. Your latest OwnIndex and the testing date are displayed.
3. Scroll up or down to see your latest  $HR_{max-p}$  and the testing date.
4. **Lie down and relax** yourself for 1-3 minutes before the test.

### **Start the Test**

It takes 3-5 minutes to carry out the test.

5. Press OK to start the test. The wrist receiver starts searching for your heart rate. TEST On and your heart rate are displayed. The test begins.
6. Lie relaxed. Keep your hands beside your body and avoid body movements. Don't communicate with other people.
7. Your current OwnIndex and the testing date are displayed.
8. If  $HR_{max-p}$  is on: Scroll up or down to see the  $HR_{max-p}$  result and the testing date.

### **Turn the Fitness Test Sound Signal on/off**

The sound signal will alarm you at the end of the test. If the sound signal is on  appears on the display.

- To turn the sound signal on or off either before or during the test, press and hold the signal/light button.

## Interrupt the Test

- You can stop the test any time during the test by pressing the stop button. Failed TEST is displayed for a few seconds.  
The latest OwnIndex and  $HR_{max-p}$  are not replaced.

If the wrist receiver does not succeed in receiving your heart rate at the beginning or during the test, the test will fail. Check that the transmitter electrodes are wet and the elastic strap is snug enough.

## Update OwnIndex and $HR_{max-p}$

You can update your OwnIndex and  $HR_{max-p}$  values to the Options mode/ User information. When you update these values regularly, the reading in percentages of your maximum heart rate and calorie calculation give more accurate individual information.

1. In the Time of Day display scroll up or down until FIT. TEST is displayed.
2. Press OK to enter the Fitness Test mode.
3. Scroll up or down until Update USER SET is displayed. This display appears if you have not updated your latest test results.
4. Press OK to update the OwnIndex and  $HR_{max-p}$  values.
5. To return to the Time of Day display, press and hold the stop button.

! Your maximum heart rate value is updated if the  $HR_{max-p}$  is on.

## Fitness Classes

The Polar Fitness Test result, your OwnIndex, is most meaningful when comparing your individual values and changes in them. OwnIndex can also be interpreted according to your gender and age. Locate your OwnIndex on the table to find your current cardiovascular fitness classification, compared with those who are of the same age and gender.

	Age (years)	1 (very poor)	2 (poor)	3 (fair)	4 (average)	5 (good)	6 (very good)	7 (excellent)
<b>MEN</b>	20-24	< 32	32-37	38-43	44-50	51-56	57-62	>62
	25-29	< 31	31-35	36-42	43-48	49-53	54-59	>59
	30-34	< 29	29-34	35-40	41-45	46-51	52-56	>56
	35-39	< 28	28-32	33-38	39-43	44-48	49-54	>54
	40-44	< 26	26-31	32-35	36-41	42-46	47-51	>51
	45-49	< 25	25-29	30-34	35-39	40-43	44-48	>48
	50-54	< 24	24-27	28-32	33-36	37-41	42-46	>46
	55-59	< 22	22-26	27-30	31-34	35-39	40-43	>43
60-65	< 21	21-24	25-28	29-32	33-36	37-40	>40	
<b>WOMEN</b>	20-24	< 27	27-31	32-36	37-41	42-46	47-51	>51
	25-29	< 26	26-30	31-35	36-40	41-44	45-49	>49
	30-34	< 25	25-29	30-33	34-37	38-42	43-46	>46
	35-39	< 24	24-27	28-31	32-35	36-40	41-44	>44
	40-44	< 22	22-25	26-29	30-33	34-37	38-41	>41
	45-49	< 21	21-23	24-27	28-31	32-35	36-38	>38
	50-54	< 19	19-22	23-25	26-29	30-32	33-36	>36
	55-59	< 18	18-20	21-23	24-27	28-30	31-33	>33
60-65	< 16	16-18	19-21	22-24	25-27	28-30	>30	

The classification is based on literature review of 62 studies where  $VO_{2max}$  was measured directly in healthy adult subjects in the USA, Canada and 7 European countries. Reference: Shvartz E, Reibold RC: Aerobic fitness norms for males and females aged 6 to 75 years: a review. Aviat Space Environ Med; 61:3-11, 1990.

Download from [Www.Somanuals.com](http://www.Somanuals.com). All Manuals Search And Download.

For various fitness classes we recommend the following:

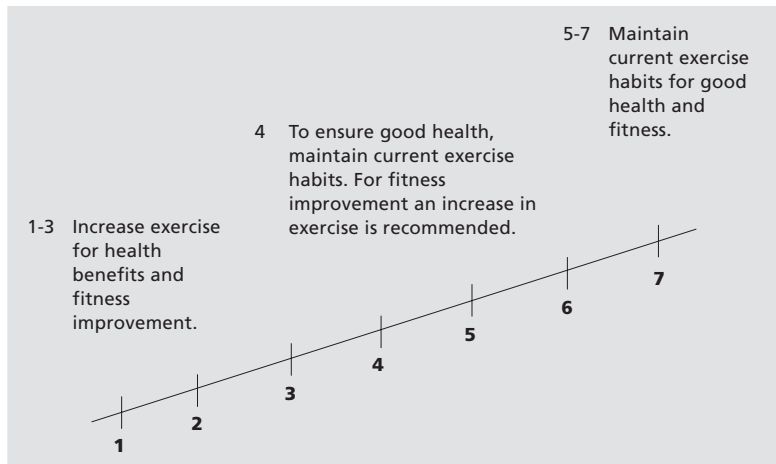

Top athletes typically score OwnIndex values above 70 (men) and 60 (women). Values as high as 95 can be reached by athletes of Olympic caliber. OwnIndex is highest in sports that involve large muscle groups such as cross-country skiing and cycling.



# G. CARE AND MAINTENANCE

Your Polar heart rate monitor is a high-tech instrument of superior design and workmanship and should be treated with care. The suggestions below will help you fulfill the guarantee obligations and enjoy this product for many years to come.

## **Taking Care of Your Polar Heart Rate Monitor**

- Wash the transmitter regularly after use with a mild soap and water solution. Dry it carefully after washing with soft towel.
- Never store the transmitter wet. Sweat and moisture can keep its electrodes wet and the transmitter activated, which shortens the battery life.
- Store your Polar heart rate monitor in a cool and dry place. Do not store it in any kind of non-breathing material, such as a plastic bag or a sports bag if it is wet.
- Do not bend or stretch the transmitter. This may damage the electrodes.
- Do not dry the transmitter in any other way than with a towel. Mishandling may damage the electrodes.
- Keep your Polar heart rate monitor out of extreme cold and heat. The operating temperature is 14 °F to 122 °F/ -10 °C to 50 °C.
- Do not expose the Polar heart rate monitor to direct sunlight for extended periods, such as by leaving it in a car.

## **Batteries**

### **Transmitter**

The estimated average battery life of the transmitter is 2500 hours of use. Contact your authorized Polar service center for a replacement transmitter. Polar recycles used transmitters. See your Customer Care Charter for detailed instructions.

### **Wrist Receiver**

The estimated average battery life of the wrist receiver is 2 years in normal use (2h/ day, 7 days a week). Please note that excessive use of the backlight and the alarm signals will drain the battery more rapidly. Do not open the wrist receiver yourself. To ensure the water resistance properties and the use of qualified components, the wrist receiver battery should be replaced by an authorized Polar Service Center only. At the same time a full periodic check of the Polar heart rate monitor will be done.

## **Service**

Should your Polar heart rate monitor need service, see the Customer Care Charter to contact an authorized Polar Service Center.

**!** Water resistance cannot be guaranteed after unauthorized service.

# H. PRECAUTIONS

## Using the Polar Heart Rate Monitor in a Water Environment

Your Polar heart rate monitor is water resistant to 160 feet/ 50 meters. To maintain the water resistance, do not operate the buttons of the wrist receiver under water.

Users measuring heart rate in a water environment may experience interference for the following reasons:

- Pool water with a high chlorine content and seawater are very conductive. The electrodes of a Polar transmitter may become short circuited which prevents EKG signals from detection by the transmitter unit.
- Jumping into the water or strenuous muscle movement during competitive swimming may cause water resistance that shifts the transmitter on the body to a location where it is not possible to pick up ECG signal.
- The ECG signal strength varies depending on the individual's tissue composition and the percentage of people who have problems in heart rate measuring is considerably higher in a water environment than in other use.

## Polar Heart Rate Monitor and Interference

### Electromagnetic Interference

Disturbances may occur near high voltage power lines, traffic lights, overhead lines of electric railways, electric bus lines or trams, televisions, car motors, bike computers, some motor driven exercise equipment, cellular phones or when you walk through electric security gates.

### Crosstalk

The Polar wrist receiver in non-coded mode (mode is indicated by heart symbol without frames) of operation picks up transmitter signals within 3 feet/ 1 meter. Non-coded signals, from more than one transmitter picked up simultaneously, can cause an incorrect readout.

### Exercise Equipment

Several pieces of exercise equipment with electronic or electrical components such as LED displays, motors and electrical brakes may cause interfering stray signals. To try to tackle these problems, relocate the Polar wrist receiver as follows:

1. Remove the transmitter from your chest and use the exercise equipment as you would normally.
2. Move the wrist receiver around until you find an area in which it displays no stray reading or flashing of the heart symbol. Interference is often worst right in front of the display panel of the equipment, while the left or right side of the display is relatively free of disturbance.
3. Put the transmitter back on the chest and keep the wrist receiver in this interference-free area as far as it is possible.

4. If the Polar heart rate monitor still does not work with the exercise equipment, this piece of equipment may be electrically too noisy for wireless heart rate measurement.

## Minimizing Possible Risks in Exercising with a Heart Rate Monitor

Exercise may include some risk, especially for those who have been sedentary.

Before starting a regular exercise program an individual is recommended to answer to the following questions for health status checking. If the answer is yes to any of the questions, we recommend to consult a doctor before starting an exercise program.

- Have you not exercised for the past 5 years?
- Do you have high blood pressure?
- Do you have high blood cholesterol?
- Do you have symptoms of any disease?
- Are you taking any blood pressure or heart medication?
- Do you have a history of breathing problems?
- Are you recovering from a serious illness or medical treatment?
- Do you use a pacemaker or another implanted electronic device?
- Do you smoke?
- Are you pregnant?

Note that in addition to exercise intensity, medications for heart, blood pressure, psyche, asthma, breathing etc. as well as some energy drinks, alcohol and nicotine can affect heart rate.

**It is important to be sensitive to your body's reactions during the exercise.** If you feel unexpected pain or tiredness regarding your exercise intensity level, it is recommended to stop the exercise or continue at a lighter intensity.

**Notice to persons with pacemakers, defibrillator or other implanted electronic device.** Persons who have a pacemaker use the Polar heart rate monitor at their own risk. Before starting use, we always recommend an exercise test under doctor's supervision. The test is to ensure the safety and reliability of the simultaneous use of the pacemaker and the heart rate monitor.

**If you are allergic to any substance that comes into contact with the skin or if you suspect an allergic reaction due to using the product,** check the listed materials in the "Technical Specifications" chapter. To avoid any skin reaction risk with the transmitter, wear it over a shirt. However, moisten the shirt well under the electrodes to ensure flawless operation.

! The combined impact of moisture and intense abrasion may cause a black color, which might stain light-colored clothes especially, to come off the transmitter's surface.

# I. FREQUENTLY ASKED QUESTIONS

## What should I do if...

### **...I don't know where I am in the Options or File cycle?**

Press and hold the stop button until time of day is displayed.

### **...I cannot find the previous exercise's file?**

You may have used the Measure mode during your exercise, which means that your exercise was not stored. To record the exercise you have to turn the stopwatch on by pressing the OK button in the Measure mode.

### **...I cannot find the expended calories from my exercise file?**

Check that you have set your personal user information and turned the OwnCal function on. Check that your heart rate has reached over 90 bpm or above 60 % of your maximum heart rate during your exercise.

### **...I cannot turn my HR<sub>max</sub>-p on?**

Check that you have set your personal user information and turned the fitness test on before turning the HR<sub>max</sub>-p on.

### **...there is no heart rate reading (- -)?**

1. Check that the electrodes of the transmitter are moistened and that you are wearing it as instructed.
2. Check that you have kept the transmitter clean.
3. Check that you are not near other people that have heart rate monitors, high voltage power lines, televisions, mobile phones or other sources of electromagnetic disturbance.
4. Have you had a cardiac event which may have altered your EKG waveform? In this case consult your physician.

### **...the code search was not successful and the frame around the heart symbol has disappeared?**

Bring the receiver up to your chest near the transmitter's Polar logo. The receiver starts looking for a heart rate signal again. If you still do not succeed in code searching, but your heart rate is displayed and the heart symbol without a frame is flashing, you can start exercising. However, your wrist receiver may become disturbed by other heart rate monitors.

### **...heart symbol flashes irregularly?**

1. Check that the wrist receiver is not further than 3 feet/ 1 meter from the transmitter.
2. Check that the elastic strap has not become loose during exercise.
3. Make sure that the electrodes of the transmitter are moistened.
4. Make sure that there is no other heart rate transmitter within 3 feet/ 1 meter.
5. Cardiac arrhythmia may cause irregular readings. In this case consult your physician.



### **...other person with heart rate monitor is causing interference?**

Keep a distance from your training partner and continue your training session normally.

#### **Or**

1. Take the transmitter off your chest for 30 seconds. Keep a distance from your training partner.
2. Put the transmitter back and bring the receiver up to your chest near the transmitter's Polar logo. The receiver starts looking for a heart rate signal again. Continue your training session normally.

### **...heart rate reading becomes erratic or extremely high?**

You may have come within range of strong electromagnetic signals which cause erratic readings. Check your surroundings and move further away from the source of disturbance.

### **...the display is blank or fading?**

If the display is blank, activate the wrist receiver by pressing the OK button twice, after which the Time of Day display appears. The first sign of a discharged battery is the battery symbol on the display. Also the digits fade when the backlight is used. Have the batteries checked.

### **...there are no reactions to any buttons?**

Reset the Polar heart rate monitor. Resetting clears watch settings which will return to the default settings. User information and measuring units settings will be saved.

1. Press the RESET button with a pen tip. Display becomes full of digits. If you don't press any button after reset within one minute the wrist receiver goes to the Time of Day display.
2. Press any of the buttons once. The time of day is displayed.

### **...the battery of the wrist receiver must be replaced?**

We recommend having all service done by an authorized Polar Service Center. The guarantee does not cover damage or consequential damage caused by service not authorised by Polar Electro. Polar Service will test your wrist receiver for water resistance after battery replacement and make a full periodic check of the complete Polar heart rate monitor.

### **...the data transfer from receiver to computer was unsuccessful?**

1. Check the correct position of the wristwatch receiver with the infrared window of the computer or the optional interface.
2. Check that the surroundings are not too bright. This problem often occurs near windows.
3. Check that there is no obstruction between the infrared windows.

# J. TECHNICAL SPECIFICATION

**Polar heart rate monitor is designed to indicate the level of physiological strain and intensity in sports and exercise. No other use is intended or implied. Heart rate is displayed as number of heartbeats per minute (bpm).**

## **Transmitter**

Battery type:	Built-in Lithium Cell
Battery life:	Average 2500 hours of use
Operating temperature:	14 °F to 122 °F/ -10 °C to +50 °C
Material:	Polyurethane
Waterproof	

## **Elastic Strap**

Buckle material:	Polyurethane
Fabric material:	Nylon, polyester and natural rubber including a small amount of latex

## Wrist Receiver

Battery type:	CR 2430
Battery life:	Average 2 years (2h/ day, 7 days/ week)
Operating temperature:	14 °F to 122 °F/ -10 °C to +50 °C
Water resistance:	to 50 metres / 160 feet
Wrist strap material:	Polyurethane
Backcover and wrist strap buckle material:	Stainless steel complying with EU Directive 94/27/EU and its amendment 1999/C 205/05 on the release of nickel from products intended to come into direct and prolonged contact with the skin.

Watch accuracy better than  $\pm 0,5$  seconds/ day at 77 °F/ 25 °C temperature.  
Polar S610i is a Class 1 Laser Product.

Accuracy of heart rate measurement:  $\pm 1\%$  or  $\pm 1$  bpm, whichever larger, definition applies to steady state conditions.

## Default Settings

In USA and Canada		Activity	Low
Time of day	12 h	HR <sub>max</sub>	220-age
In other countries		VO <sub>2max</sub>	
Time of day	24 h	male	45
Alarm	OFF	female	35
Date of Birth	0	Activity sound	On
(adjustable for year is 1921 - 2020)		In USA and Canada	
Sex	Male	Units	2
Weight	0	In other countries	
Height	0	Units	1
		Help	On

OwnCal	OFF
Fitness test	On
HR <sub>max</sub> -p	OFF
Interval function	OFF/ interval timer
Interval heart rate	160
Amount of intervals	3
Timer 1, 2, 3	OFF/ 2 min
Limits 1, 2, 3	80/ 160
Recovery function	OFF/ recovery timer
Recovery heart rate	80
Recovery timer	1 min
Heart touch function	Shows heart rate limits
Recording rate	5 s

### **Limit Values**

Exercise time	99 h 59 min 59 s
Heart rate limits	30 - 240
Heart rate zone time	99 h 59 min 59 s
Recovery time	99 min 59 s
Calories	99 999 kcal
Cumulative calories	999 999 kcal
Cumulative exercise time	9999 h
Interval phases recorded to memory	30

# K. LIMITED POLAR INTERNATIONAL GUARANTEE

- This limited Polar international guarantee is issued by Polar Electro Inc. for the consumers who have purchased this product in the USA or Canada. This limited Polar international guarantee is issued by Polar Electro Oy for the consumers who have purchased this product in other countries.
- Polar Electro Inc. / Polar Electro Oy guarantees to the original consumer/purchaser of this product that the product will be free from defects in material or workmanship for two years from the date of purchase.
- **Please keep the receipt or International Guarantee Card, which is your proof of purchase!**
- The guarantee does not cover the battery, damage due to misuse, abuse, accidents or non-compliance with the precautions; improper maintenance, commercial use, cracked or broken cases.
- Guarantee does not cover any damage/s, losses, costs or expenses, direct, indirect or incidental, consequential or special, arising out of, or related to the product. During the guarantee period the product will be either repaired or replaced at an authorized service center free of charge.
- This guarantee does not affect the consumer's statutory rights under applicable national or state laws in force, or the consumer's rights against the dealer arising from their sales/ purchase contract.



This CE marking shows compliance of this product with Directive 93/42/EEC.

Copyright © 2000, 2002, 2003 Polar Electro Oy, FIN-90440 KEMPELE, Finland. All rights reserved. No part of this manual may be used or reproduced in any form or by any means without prior written permission of Polar Electro Oy. The names and logos marked with a <sup>TM</sup> symbol in this user's manual or in the package of this product are trademarks of Polar Electro Oy, except that Sound Blaster is a trademark of Creative Technology, Ltd. The names and logos marked with a ® symbol in this user's manual or in the package of this product are registered trademarks of Polar Electro Oy, except that Windows is a registered trademark of Microsoft Corporation.

Download from [Www.Somanuals.com](http://Www.Somanuals.com). All Manuals Search And Download.

# L. DISCLAIMER

- The material in this manual is for informational purposes only. The products it describes are subject to change without prior notice, due to the manufacturer's continuous development program.
- Polar Electro Inc. / Polar Electro Oy makes no representations or warranties with respect to this manual or with respect to the products described herein. Polar Electro Inc. / Polar Electro Oy shall not be liable for any damages, losses, costs or expenses, direct, indirect or incidental, consequential or special, arising out of, or related to the use of this material or the products described herein.

This product is protected by one or several of the following patents:  
FI 88223, DE 4215549, FR 92.06120, GB 2257523, HK 113/1996,  
SG 9591671-4, US 5491474, FI 88972, DE 9219139.8, FR 92.09150,  
GB 2258587, HK 306/1996, SG 9592117-7, US 5486818, FI 96380, US 5611346,  
EP 665947, DE 69414362, FI 68734, DE 3439238, GB 2149514, HK 812/1989,  
US 4625733, FI 100924, FI 100452, US 5840039, FI 4150, DE 20008882.3,  
US 6477397, FR 0006504, FI 4069, US 6272365, FR 9907823, GB 2339833,  
DE 29910633, FI 104463, US 6183422, FI 4157, DE 20008883.1, FR 0006778,  
WO 97/33512, GB 2326240, FI 107776, US 6327486, US 6277080, US 6361502,  
US 5719825, US 5848027, EP 1055158.

Other patents pending.

Download from [Www.Somanuals.com](http://Www.Somanuals.com). All Manuals Search And Download

# M. POLAR GLOSSARY

**Activity level:** A personal assessment of your long term physical activity level that is used in the Polar Fitness Test.

**Coded heart rate transmission:** Polar coded transmitter automatically locks in a code to transmit your heart rate to the wrist receiver. In a coded transmission the receiver accepts heart rate data only from the Polar coded transmitter. Coding significantly reduces crosstalk caused by other users of heart rate monitors. However, it does not necessarily reduce all environmental interference.

**Configuring the display:** During the exercise you can modify display options by selecting information to the lower and upper rows.

**Electrodes:** The grooved areas of the transmitter that rest against the skin and pick up the EKG signal.

**Exercise mode:** The stopwatch is on and your exercise is recorded. You can select between the BasicUse, Interval Training Set and BasicSet.

**Heart rate:** The number of heart beats per minute (bpm).



**Heart touch function:** When you are in Exercise mode, bring your wrist receiver close to the Polar logo on your transmitter.

**Interval training:** Seeks to improve your race pace with different periods of work and rest.

**Maximal oxygen uptake:** (maximal aerobic power,  $VO_{2max}$ )  
Is the maximal rate at which oxygen can be used by the body during maximal work.  $VO_{2max}$  is a good measure of aerobic fitness.

**Maximum heart rate:** ( $HR_{max}$ )  
Is the highest number of heart beats per minute of a person.

**Measure mode:** Measuring your heart rate without recording the exercise.

**Target heart rate zone:** The area between the upper and lower target heart rate limits. Target zone selection is based on personal fitness goals.

## Display Symbols

♥ Indicates an ongoing heart rate measurement and flashes to the beat of your heart. A heart without frames indicates a non-coded heart rate transmission.

♥ Indicates a frame around the heart indicates a coded transmission of heart rate.

⊞ Indicates there has not been heart rate reception for at least 5 seconds.

-- Indicates there is no heart rate reception. Bring the wrist receiver up to your chest near the transmitter's Polar logo. The receiver starts looking for the heart rate signal again.

In the Time of Day display the alarm is on.

ⓘ)) Measure mode: beeps if you are exercising outside your target heart rate zone. Fitness Test mode: sounds an alarm at the end of the fitness test.

▮▮▮ Indicates the Interval Trainer.

▮▮▮: Indicates continuous interval (Cont).

▲ Exercise mode: indicates the heart rate above the target zone.

▼ Exercise mode: indicates the heart rate below the target zone.

▮▮▮▮▮ The graphic bar consists of five blocks. A flashing block indicates in which level you are in the Options settings or File recalling loops.  
▮▮▮▮▮ Continuously running bars indicate that the exercise is recorded.

⊞ Indicates low battery.

Download from [Www.Somanuals.com](http://Www.Somanuals.com). All Manuals Search And Download.

## Display Texts

**ALARM:** Indicates the alarm in watch settings.

**AM or PM:** Are used in 12h time mode. Ex. in 24h time mode 13:00 means 1:00 PM.

**AVG:** Together with a reading indicates average heart rate.

**BasicUse:** Exercising without settings.

**BestLap:** Indicates the shortest lap time information.

**CONNECT:** Communication mode between wrist receiver and computer.

**Cont:** Up to 30 intervals succeed one another unless the Interval phase is manually stopped.

**CoolDown:** Cool-down phase at the end of an interval training exercise.

**E0:** BasicUse settings.

**E1-E5:** Indicates which exercise set you have used for the exercise.

**ExeSet:** Start setting your BasicSet (Int OFF) or Interval Training Set (Int On).

**Exe. Time:** Exercise duration.

**FILE:** Indicates file mode.

**FIT. TEST:** Indicates fitness test mode.

**FULL:** After having stored 99 laps (the use of intervals reduces the amount). FULL appears in the display. You can continue taking lap times or intervals but they won't be recorded into the file.

**HR<sub>max</sub> -p:** Predicted maximum heart rate value.

**Interval, Int:** Options mode: indicates Interval Training Set.

Exercise mode: Indicates interval exercise session including warm-up, interval and cool-down phases.

**InZone/ Above/ Below:** Indicate the time spent within, above and below the target zone.

**KCal:** Indicates the energy expenditure of your exercise.

**LAPS:** Indicates how many lap times have been stored.

**Lim High:** The higher heart rate limit of the target zone.

**Lim Low:** The lower heart rate limit of the target zone.

**Limits 1, 2, 3:** Heart rate limits for Target Zones 1, 2 and 3.

**MAX:** Together with a heart rate reading indicates the highest heart rate.

**MAX %:** Together with a heart rate reading indicates what percentage your current heart rate is of your maximum heart rate.

**Mem full:** Appears on the display when the memory is full. You can continue your exercise and taking lap times but they won't be recorded into the file.

**OPTIONS:** Indicates the Options mode.

**OwnCal:** Calculates energy expenditure during exercise in kilocalories. 1 kilocalorie (kcal) = 1000 calories (cal). You can follow how much energy you lose by exercising in one exercise session or in a day, week or even a year. The OwnCal can be used as a dose measure of exercise Ex. in nutrition

planning. OwnCal calorie calculation starts when your heart rate reaches 90 bpm or is above 60% of your maximum heart rate, whichever is smaller. These limits are set to count only exercise calories. The higher the heart rate, the faster the energy expenditure. OwnCal is individually calibrated by your preset weight, maximal oxygen uptake ( $VO_{2max}$ ) and maximum heart rate ( $HR_{max}$ ). The most accurate OwnCal is received by entering your clinically measured (in maximal treadmill or bicycle stress test)  $VO_{2max}$  and  $HR_{max}$  into the wrist receiver. Energy expenditure measurement is most accurate in continuous activities such as cycling and running.

**OwnINDEX:** Result of Polar Fitness Test and comparable score with maximal oxygen uptake ( $VO_{2max}$ ) in ml/kg/min.

### **RecoHr, heart-rate-based**

**recovery:** You set the heart rate, which will end your recovery calculation. In the File mode you

will see the drop in your heart rate and the recovery duration.

**RecoTime, time-based recovery:**

You set the recovery time in the Options mode. In the File mode you will see the drop in your heart rate and the recovery duration.

**Split Time:** The elapsed time from the beginning of the exercise until storing the split time.

**Sw:** Indicates stopwatch.

**Timer1, 2, 3:** Interval Training mode: Countdown timers for the Interval Training set.

**WarmUp:** Warm-up phase in the beginning of an Interval Training exercise.

## Free Manuals Download Website

<http://myh66.com>

<http://usermanuals.us>

<http://www.somanuals.com>

<http://www.4manuals.cc>

<http://www.manual-lib.com>

<http://www.404manual.com>

<http://www.luxmanual.com>

<http://aubethermostatmanual.com>

Golf course search by state

<http://golfingnear.com>

Email search by domain

<http://emailbydomain.com>

Auto manuals search

<http://auto.somanuals.com>

TV manuals search

<http://tv.somanuals.com>