

**2008  
Outlaw 450 S  
Outlaw 525 S**

**Owner's Manual  
for Maintenance  
and Safety**



**POLARIS®**  
The Way Out.



*This Category "S" (Sport) ATV is a high-performance ATV for off-road use only. It is for sport-type recreational and competitive use by operators with advanced skills and substantial experience. Operation is prohibited for anyone under 16 years of age.*

**Read this manual carefully.  
It contains important safety information.**

# **⚠️ WARNING**

**Improper vehicle use can result in  
SEVERE INJURY or DEATH.**



**ALWAYS USE  
AN APPROVED  
HELMET AND  
PROTECTIVE  
GEAR**



**NEVER USE  
ON PUBLIC  
ROADS**



**NEVER CARRY  
PASSENGERS**



**NEVER USE  
WITH DRUGS  
OR ALCOHOL**

**READ OWNER'S MANUAL. FOLLOW  
ALL INSTRUCTIONS AND WARNINGS.**

## **NEVER:**

- Operate without proper training or instruction.
- Operate on public roads. A collision can occur with another vehicle.
- Operate at speeds too fast for your skills or conditions.
- Use **ALCOHOL** or **DRUGS** before or while operating this vehicle.
- Carry Passengers.

## **ALWAYS:**

- Avoid paved surfaces, which may adversely affect handling and control.
- Use proper **RIDING TECHNIQUES** to avoid vehicle overturns on hills, on rough terrain and in turns.
- Wear eye protection, helmet and protective apparel.



**POLARIS**  
The Way Out.®

**For your nearest Polaris dealer, call 1-800-POLARIS  
or visit [www.polarisindustries.com](http://www.polarisindustries.com)**

**Polaris Sales Inc., 2100 Hwy 55**

**Medina, MN 55340**

**Phone 1-888-704-5290**

**Part No. 9921184 Rev 01**

**Printed in USA**

**⚠ WARNING**

The engine exhaust from this product contains chemicals known to the State of California to cause cancer, birth defects or other reproductive harm.

A card containing important ATV safety information should be attached to the owner's manual on the next page. If you cannot locate this card, or if it has been removed, please call 1-800-342-3764 for assistance.

**Visit us at [www.polarisindustries.com](http://www.polarisindustries.com)**



POLARIS and POLARIS THE WAY OUT are registered trademarks of Polaris Industries Inc.

Copyright 2007 Polaris Sales Inc. All information contained within this publication is based on the latest product information at the time of publication. Due to constant improvements in the design and quality of production components, some minor discrepancies may result between the actual vehicle and the information presented in this publication. Depictions and/or procedures in this publication are intended for reference use only. No liability can be accepted for omissions or inaccuracies. Any reprinting or reuse of the depictions and/or procedures contained within, whether whole or in part, is expressly prohibited.

Printed in U.S.A.

2008 Outlaw 450 S/525 S ATV Owner's Manual

P/N 9921184

## Welcome

Thank you for purchasing a Polaris vehicle, and welcome to our world-wide family of Polaris owners. We proudly produce an exciting line of utility and recreational products.

- Snowmobiles
- All-terrain vehicles (ATVs)
- *RANGER* utility vehicles
- Victory motorcycles

## Welcome

We believe Polaris sets a standard of excellence for all utility and recreational vehicles manufactured in the world today. Many years of experience have gone into the engineering, design, and development of your Polaris vehicle, making it the finest machine we've ever produced.

For safe and enjoyable operation of your vehicle, be sure to follow the instructions and recommendations in this owner's manual. Your manual contains instructions for minor maintenance, but information about major repairs is outlined in the Polaris Service Manual and should be performed only by a Factory Certified Master Service Dealer (MSD) Technician. Your Polaris dealer knows your vehicle best and is interested in your total satisfaction. Be sure to return to your dealership for all of your service needs during, and after, the warranty period.

We also take great pride in our Parts, Apparel and Accessories (PAA) products, available through our online store at [www.purepolaris.com](http://www.purepolaris.com). Have your accessories and clothing delivered right to your door!

## Table of Contents

Know Your Vehicle . . . . .	6	Emission Control Systems . . . . .	95
Safety Decals . . . . .	8	Maintenance . . . . .	97
Safety . . . . .	12	Specifications . . . . .	182
Features and Controls . . . . .	50	Polaris Products . . . . .	186
Break-In Period. . . . .	70	Troubleshooting. . . . .	188
Pre-Ride Inspection . . . . .	72	Warranty . . . . .	200
Operation . . . . .	74	Maintenance Log . . . . .	209
		Index . . . . .	213



## **Know Your Vehicle**

As the operator of the vehicle, you are responsible for your personal safety, the safety of others, and the protection of our environment. Read and understand your owner's manual, which includes valuable information about all aspects of your vehicle, including safe operating procedures.

### **Vehicle Identification Numbers**

Record your vehicle's identification numbers and key number in the spaces provided. Remove the spare key and store it in a safe place. An ignition key can be duplicated only by ordering a Polaris key blank (using your key number) and mating it with one of your existing keys. The ignition switch must be replaced if all keys are lost.

# Know Your Vehicle

## Vehicle Identification Numbers

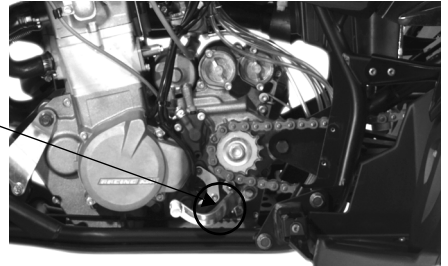

Vehicle Model Number: \_\_\_\_\_

Frame Vehicle Identification Number (1): \_\_\_\_\_

Engine Serial Number (2): \_\_\_\_\_

Key Number (on the key): \_\_\_\_\_

## Safety Decals

Warning decals have been placed on the vehicle for your protection. Read and follow the instructions on each decal carefully. If any of the decals shown in this manual differ from the decals on your vehicle, always read and follow the instructions of the decals on the vehicle.

If any decal becomes illegible or comes off, contact your Polaris dealer to purchase a replacement.

Replacement *safety* decals are provided by Polaris at no charge. The part number is printed on the decal.

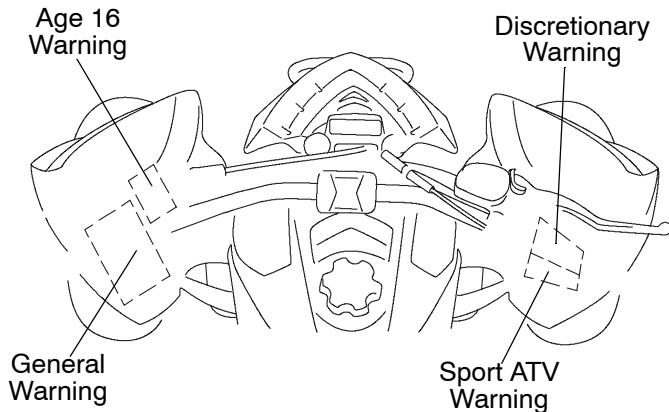

## General Warning

### WARNING

Improper ATV use can result in SEVERE INJURY OR DEATH.

Always use an approved helmet and protective gear. Never use on public roads. Never carry passengers. Never use with drugs or alcohol.

NEVER operate:

- without proper training or instruction
- at speeds too fast for your skills or the conditions
- on public roads - a collision can occur with another vehicle
- with a passenger - passengers affect balance and steering and increase risk of losing control

ALWAYS:

- use proper riding techniques to avoid vehicle overturns on hills and rough terrain and in turns
- avoid paved surfaces - pavement may seriously affect handling and control.

LOCATE AND READ OWNER'S MANUAL.  
FOLLOW ALL INSTRUCTIONS AND  
WARNINGS.

IF OWNER'S MANUAL IS MISSING, CONTACT  
A POLARIS DEALER FOR A REPLACEMENT.

7172560

## Safety Decals

### Age 16 Warning

#### WARNING

Operating this ATV if you are under the age of 16 increases your chance of severe injury or death. NEVER operate this ATV if you are under age 16.

7172559

### Sport ATV Warning

#### WARNING

This ATV may exceed the performance of other ATVs you may have ridden in the past. This category S (Sport) ATV is a high performance vehicle for off-road use only, in sport type recreation and competitive use by operators with advanced skills and substantial experience.

7173837

### Discretionary Warning

- Never operate this ATV on HILLS steeper than 25 degrees  $\angle$  25°. To prevent flipover on hilly terrain, use throttle and brakes gradually.
- REVERSE operation can be dangerous even at low speeds. Steering becomes difficult. To prevent flipover, avoid sudden braking or sharp turns.
- PARKING BRAKE may relax when used for more than 5 minutes. When parking on grades, leave ATV in gear.

7173837

## Safety Decals

### No Passenger Warning

WARNING

NEVER ride as a passenger.

Passengers can cause a loss of control, resulting in SEVERE INJURY or DEATH.

7172566

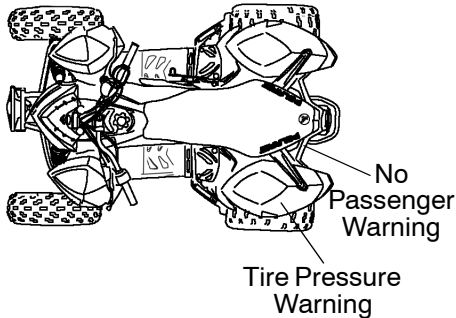

### Tire Pressure/Load Warning

WARNING

IMPROPER TIRE PRESSURE OR OVERLOADING can cause loss of control, resulting in SEVERE INJURY OR DEATH.

TIRE PRESSURE IN PSI (KPa): FRONT 4 (27.6)  
REAR 4 (27.6)

MAXIMUM WEIGHT CAPACITY

215 LBS. (97.5 KG)

INCLUDES WEIGHT OF OPERATOR, CARGO AND ACCESSORIES

Reduce speed and allow greater distance for braking when carrying cargo. Overloading or carrying tall, off-center, or unsecured loads will increase your risk of losing control. For stability on rough or hilly terrain, reduce speed and cargo.

Read Owner's Manual for more detailed loading information.

7174881

## Safety Riding Gear

Always wear clothing suited to the type of riding. ATV riding requires special protective clothing for comfort and to reduce the chance of injury.

### Helmet

Wearing a helmet can prevent a severe head injury. Whenever riding a Polaris vehicle, always wear a helmet that meets or exceeds established safety standards.

Approved helmets in the USA and Canada bear a U.S. Department of Transportation (DOT) label.

Approved helmets in Europe, Asia and Oceania bear the ECE 22.05 label. The ECE mark consists of a circle surrounding the letter E, followed by the distinguishing number of the country which has granted approval. The approval number and serial number will also be displayed on the label.

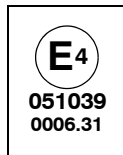
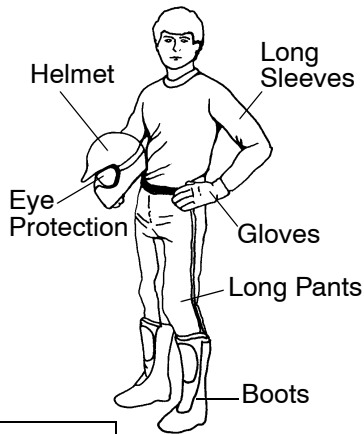

## Riding Gear

### Eye Protection

Do not depend on eyeglasses or sunglasses for eye protection. Whenever riding a Polaris vehicle, always wear shatterproof goggles or use a shatterproof helmet face shield. Polaris recommends wearing approved Personal Protective Equipment (PPE) bearing markings such as VESC 8, V-8, Z87.1, or CE. Make sure protective eye wear is kept clean.

### Gloves

Off-road style gloves with knuckle pads are the best for comfort and protection.

### Boots

The best footwear is a pair of strong over-the-calf boots with low heels.

### Clothing

Always wear long sleeves and long pants to protect arms and legs. Riding pants with knee-pads and a jersey with shoulder pads provide the best protection.



# Safety

## Operator Safety

### **WARNING**

Failure to follow the warnings in this manual can result in severe injury or death.

A Polaris ATV is not a toy and can be hazardous to operate. This vehicle handles differently than other vehicles such as motorcycles and cars. A collision or rollover can occur quickly, even during routine maneuvers like turning, or driving on hills or over obstacles, if you fail to take proper precautions.

Read and understand the owner's manual and all warnings before operating a Polaris ATV.

### **Operator Restrictions/Age Restrictions**

This vehicle is an **ADULT VEHICLE ONLY**. Operation is prohibited for anyone under 16 years of age. This category S (Sport) ATV is a high performance vehicle intended for off road use only, for sport-type recreation and for competitive use by operators with advanced skills and substantial experience.

## Operator Safety Safety Training

ATV safety training is a top priority for Polaris. When you purchased your new ATV, your dealer instructed you on the authorized *ATV RiderCourse*<sup>sm</sup> available to you and your eligible family members. This training is included in the purchase price of your ATV. Polaris strongly encourages you and your age eligible family members who will be riding the ATV to take the *ATV RiderCourse*<sup>sm</sup>.

You were also provided with printed materials that explain safe operating procedures. You should review this information on a regular basis.

If you purchased a used Polaris ATV, you can take the *ATV RiderCourse*<sup>sm</sup> by calling ATV Enrollment Express at (800) 887-2887 or by visiting [www.atvsafety.org](http://www.atvsafety.org). Purchasers of a used Polaris ATV will be charged for this training.

A Polaris ATV is an off-road vehicle. Familiarize yourself with all laws and regulations concerning the operation of this vehicle in your area.

Follow the recommended maintenance program outlined in your owner's manual. This program is designed to ensure that all critical components on your vehicle are thoroughly inspected at specific intervals.

# Safety

## Operator Safety

The following signal words and symbols appear throughout this manual and on your vehicle. Your safety is involved when these words and symbols are used. Become familiar with their meanings before reading the manual.



The *safety alert symbol*, on your vehicle or in this manual, alerts you to the potential for injury.

### **WARNING**

The *safety alert warning* indicates a potential hazard that may result in serious injury or death.

### **CAUTION**

The *safety alert caution* indicates a potential hazard that may result in minor injury or damage to the vehicle.

### **CAUTION**

A *caution* indicates a situation that may result in damage to the vehicle.

### **NOTE:**

A *note* will alert you to important information or instructions.

## Operator Safety

### **WARNING**

Serious injury or death can result if you do not follow these instructions and procedures, which are outlined in further detail within your owner's manual.

- Read this manual and all labels carefully. Follow all operating procedures.
- Never operate an ATV without proper instruction. *Take a training course.* Purchasers of a new Polaris ATV and age eligible family members are entitled to take the *ATV RiderCourse<sup>sm</sup>*. Contact ATV Enrollment Express at (800) 887-2887 or visit [www.atvsafety.org](http://www.atvsafety.org) for information on enrollment in the *ATV RiderCourse<sup>sm</sup>*.
- Never allow anyone under 16 years of age to operate this ATV.
- Never permit a guest to operate the ATV unless the guest has read this manual and all product labels and has completed a certified safety training course.
- Always avoid operating an ATV on any paved surfaces, including sidewalks, driveways, parking lots and streets.

# Safety

## Operator Safety

- Never operate an ATV on a public street, road or highway, including a dirt or gravel road.
- Never operate an ATV without wearing an approved helmet that fits properly. Always wear eye protection (goggles or face shield), gloves, boots, a long-sleeved shirt or jacket, and long pants.
- Never consume alcohol or drugs before or while operating an ATV.
- Never operate at excessive speeds. Travel at speeds appropriate for the terrain, visibility and operating conditions, and your experience.
- Never attempt jumps or other stunts.
- Never tow or pull an object behind the ATV.
- Always inspect your ATV before each use to make sure it's in safe operating condition. Always follow the inspection and maintenance procedures and schedules outlined in your owner's manual.
- Always keep both hands on the handlebars and both feet on the footpegs of the ATV during operation.
- Always travel slowly and use extra caution when operating on unfamiliar terrain. Be alert to changing terrain conditions.

## Operator Safety

- Never operate on excessively rough, slippery or loose terrain.
- Always follow proper turning procedures as described in this manual. Practice turning at low speeds before attempting to turn at faster speeds. Do not turn at excessive speeds.
- Always have the ATV inspected by an authorized Polaris dealer if it's been involved in an accident.
- Never operate the ATV on hills too steep for the ATV or for your abilities. Practice on smaller hills before attempting larger hills.
- Always follow proper procedures for climbing hills. Check the terrain carefully before ascending a hill. Never climb hills with excessively slippery or loose surfaces. Shift your weight uphill. Never open the throttle suddenly or make sudden gear changes. Never go over the top of a hill at high speed
- Always follow proper procedures for going downhill and for braking on hills. Check the terrain carefully before you start down a hill. Shift your weight uphill. Never go down a hill at high speed. Avoid going down a hill at an angle, which would cause the vehicle to lean sharply to one side. Drive straight downhill.

# Safety

## Operator Safety

- Always follow proper procedures for crossing the side of a hill. Avoid hills with excessively slippery or loose surfaces. Shift your weight uphill. Never attempt to turn the ATV around on any hill until you've mastered (on level ground) the turning technique outlined in this manual. Avoid crossing the side of a steep hill when possible.
- Always use proper procedures if you stall or roll backwards while climbing a hill. To avoid stalling, maintain a steady speed when climbing a hill. If you stall or roll backwards, follow the special procedure for braking described in this manual. Always dismount on the uphill side, or to either side if the ATV is pointed straight uphill. Turn the ATV around and remount following the procedure described in this manual.

### Operator Safety

- Always be careful of skidding or sliding. On slippery surfaces like ice, travel slowly and use extra caution to reduce the chance of skidding or sliding out of control.
- Always check for obstacles before operating in a new area. Never attempt to operate over large obstacles, such as rocks or fallen trees. Always follow proper procedures when operating over obstacles as described in this manual.
- Avoid operating the ATV through deep or fast-flowing water. If it's unavoidable, travel slowly, balance your weight carefully, avoid sudden movements, and maintain a slow and steady forward motion. Do not make sudden turns or stops, and do not make sudden throttle changes.
- Wet brakes may have reduced stopping ability. Test the brakes after leaving water. If necessary, apply them lightly several times to allow friction to dry out the pads.



# Safety

## Operator Safety

- Always check for obstacles or people behind the ATV before operating in reverse. When it's safe to proceed in reverse, move slowly and avoid turning at sharp angles.
- Always use the size and type of tires specified for your ATV, and always maintain proper tire pressure.
- Never modify an ATV through improper installation or use of accessories.
- Never exceed the stated load capacity for your ATV.
- Always remove the ignition key when the vehicle is not in use to prevent unauthorized use or accidental starting.

**FOR MORE INFORMATION ABOUT ATV SAFETY, call the Consumer Product Safety Commission at 1-800-638-2772, or visit [www.cpsc.gov](http://www.cpsc.gov), visit [www.atvsafety.org](http://www.atvsafety.org), or call Polaris at 1-800-342-3764.**

## Operator Safety

### Equipment Modifications

We are concerned for the safety of our customers and for the general public. Therefore, we strongly recommend that consumers do not install on a Polaris ATV any equipment that may increase the speed or power of the vehicle, or make any other modifications to the vehicle for these purposes. Any modifications to the original equipment of the vehicle create a substantial safety hazard and increase the risk of bodily injury.

The warranty on your Polaris ATV is terminated if any equipment has been added to the vehicle, or if any modifications have been made to the vehicle, that increase its speed or power.

**NOTE:** The addition of certain accessories, including (but not limited to) mowers, blades, tires, sprayers, or large racks, may change the handling characteristics of the vehicle. Use only Polaris-approved accessories, and familiarize yourself with their function and effect on the vehicle.

# Safety

## Operator Safety

### WARNING

#### POTENTIAL HAZARD

Operating this ATV without proper instruction.

#### WHAT CAN HAPPEN

The risk of an accident is greatly increased if the operator does not know how to operate the ATV properly in different situations and on different types of terrain.

#### HOW TO AVOID THE HAZARD

Beginning and inexperienced operators should complete the *ATV RiderCourse*<sup>sm</sup> offered by Polaris through the SVIA. They should then regularly practice the skills learned in the course and the operating techniques described in the Owner's Manual.

For more information about the *ATV RiderCourse*<sup>sm</sup> contact ATV Enrollment Express at (800) 887-2887 or visit [www.atvsafety.org](http://www.atvsafety.org).

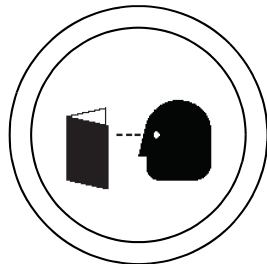

## Operator Safety

### **WARNING**

#### POTENTIAL HAZARD

Failure to follow the skill and experience recommendations for this ATV.

#### WHAT CAN HAPPEN

Severe injury and/or death could occur if a beginner or inexperienced driver operates this ATV.

#### HOW TO AVOID THE HAZARD

Only operators with advanced skills and substantial experience should operate this ATV.

# Safety

## Operator Safety

### **⚠ WARNING**

#### POTENTIAL HAZARD

Failure to follow the age recommendations for this ATV.

#### WHAT CAN HAPPEN

Severe injury and/or death could occur if a child under the minimum age recommendation operates this ATV.

Even though a child may be within the recommended age group for operating some ATVs, he/she may not have the skills, abilities, or judgment needed to operate an ATV safely and could be susceptible to accident or injury.

#### HOW TO AVOID THE HAZARD

No one under the age of 16 should operate this ATV. Only operators with advanced skills and substantial experience should operate this ATV.



## Operator Safety

### **WARNING**

#### POTENTIAL HAZARD

Carrying a passenger on an ATV.

#### WHAT CAN HAPPEN

Carrying a passenger greatly reduces the operator's ability to balance and control the ATV, which could cause an accident and injury to the operator and/or passenger.

#### HOW TO AVOID THE HAZARD

Never carry a passenger. The purpose of the long seat is to allow the operator to shift position as needed during operation. It is not intended for carrying passengers.



# Safety

## Operator Safety

### **⚠ WARNING**

#### POTENTIAL HAZARD

Operating an ATV on paved surfaces, including sidewalks, paths, parking lots, and driveways.

#### WHAT CAN HAPPEN

ATV tires are designed for off-road use. Operating on paved surfaces may adversely affect the handling of the ATV and could result in loss of control, accident, and/or injury.

#### HOW TO AVOID THE HAZARD

Avoid operating the ATV on pavement. If it's unavoidable, travel slowly and avoid sudden turns or stops.



## Operator Safety

### **WARNING**

#### POTENTIAL HAZARD

Operating this ATV on public streets, roads or highways.

#### WHAT CAN HAPPEN

The ATV could collide with another vehicle.

#### HOW TO AVOID THE HAZARD

Never operate the ATV on any public street, road or highway, including dirt and gravel roads. In many states it's illegal to operate ATVs on public streets, roads and highways.

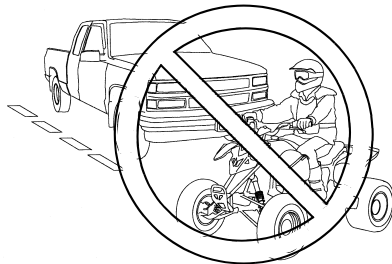



# Safety

## Operator Safety

### **⚠ WARNING**

#### POTENTIAL HAZARD

Operating this ATV without wearing an approved helmet, eye protection and protective clothing.

#### WHAT CAN HAPPEN

Operating an ATV without an approved helmet increases the risk of a severe head injury or death in the event of an accident.

Operating without eye protection could result in an accident and could increase the chance of a severe injury in the event of an accident.

#### HOW TO AVOID THE HAZARD

Always wear an approved helmet that fits properly.

Always wear eye protection (goggles or face shield), gloves, boots, long-sleeved shirt or jacket, and long pants.



## Operator Safety

### **WARNING**

#### POTENTIAL HAZARD

Operating the ATV after consuming alcohol or drugs.

#### WHAT CAN HAPPEN

Consumption of alcohol and/or drugs could seriously affect operator judgment. Reaction time may be slower and operator balance and perception could be affected.

Consuming alcohol and/or drugs before or while operating an ATV could result in an accident causing severe injury or death.

#### HOW TO AVOID THE HAZARD

Never consume alcohol or drugs before or while operating an ATV.



# Safety

## Operator Safety

### **WARNING**

#### POTENTIAL HAZARD

Operating the ATV at excessive speeds.

#### WHAT CAN HAPPEN

Excessive speed increases the operator's chance of losing control of the ATV, which can result in an accident causing severe injury or death.

#### HOW TO AVOID THE HAZARD

Always operate the ATV at a speed that's proper for the terrain, visibility and operating conditions, and your experience.

### **WARNING**

#### POTENTIAL HAZARD

Failure to inspect the ATV before operating.  
Failure to properly maintain the ATV.

#### WHAT CAN HAPPEN

Increases the possibility of an accident or equipment damage.

#### HOW TO AVOID THE HAZARD

Always inspect your ATV each time you use it to make sure the ATV is in safe operating condition. Always follow the inspection and maintenance procedures and schedules described in the Owner's Manual.

## Operator Safety

### **WARNING**

#### POTENTIAL HAZARD

Attempting jumps and other stunts.

#### WHAT CAN HAPPEN

Attempting stunts increases the chance of an accident, including an overturn.

#### HOW TO AVOID THE HAZARD

Never attempt jumps or other stunts. Avoid exhibition driving.



# Safety

## Operator Safety

### **WARNING**

#### POTENTIAL HAZARD

Towing or pulling an object behind the ATV.

#### WHAT CAN HAPPEN

A wagon, sled or other object towed behind an ATV does not have brakes or steering. The object may overturn or collide with other objects and cause serious injuries.

#### HOW TO AVOID THE HAZARD

Never tow or pull an object behind the ATV.



## Operator Safety

### **WARNING**

#### POTENTIAL HAZARD

Failure to use extra caution when operating the ATV on unfamiliar terrain.

#### WHAT CAN HAPPEN

Unfamiliar terrain may contain hidden rocks, bumps, or holes that could cause loss of control or overturn.

#### HOW TO AVOID THE HAZARD

Travel slowly and use extra caution when operating on unfamiliar terrain. Always be alert to changing terrain conditions.

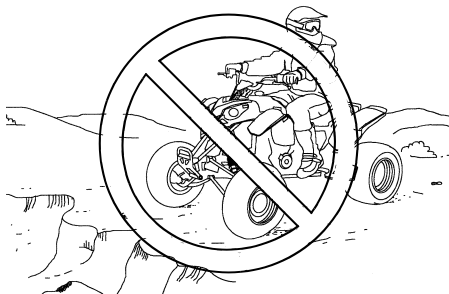

# Safety

## Operator Safety

### **⚠ WARNING**

#### POTENTIAL HAZARD

Failure to use extra caution when operating on excessively rough, slippery or loose terrain.

#### WHAT CAN HAPPEN

Operating on excessively rough, slippery or loose terrain could cause loss of traction or loss of control, which could result in an accident or overturn.

#### HOW TO AVOID THE HAZARD

Do not operate on excessively rough, slippery or loose terrain until you've learned and practiced the skills necessary to control the ATV on such terrain.

Always use extra caution on rough, slippery or loose terrain.

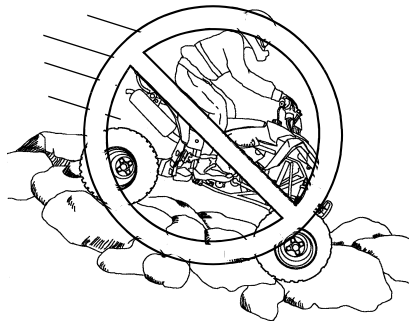

## Operator Safety

### **WARNING**

#### POTENTIAL HAZARD

Turning improperly.

#### WHAT CAN HAPPEN

Improper turns could cause loss of control and lead to a collision or overturn.

#### HOW TO AVOID THE HAZARD

Always follow proper procedures for turning as described in the owner's manual. Practice turning at slow speeds before attempting to turn at faster speeds. Never turn at excessive speed.

### **WARNING**

#### POTENTIAL HAZARD

Improperly operating in reverse.

#### WHAT CAN HAPPEN

The ATV could collide with an obstacle or person, resulting in severe injury.

#### HOW TO AVOID THE HAZARD

Before shifting into reverse gear, always check for obstacles or people behind the ATV. When it's safe to proceed, back slowly.



# Safety

## Operator Safety

### **WARNING**

#### POTENTIAL HAZARD

Removing hands from the handlebars or feet from the footpegs during operation.

#### WHAT CAN HAPPEN

Removing even one hand or foot can reduce ability to control the vehicle or could cause loss of balance and ejection from the ATV.

If the operator's foot is not firmly planted on the footpeg, it could contact the rear wheels and lead to accident or injury.

#### HOW TO AVOID THE HAZARD

Always keep both hands on the handlebars and both feet on the footpegs of the ATV during operation.



## Operator Safety

### **WARNING**

#### POTENTIAL HAZARD

Operating on excessively steep hills.

#### WHAT CAN HAPPEN

The vehicle may overturn.

#### HOW TO AVOID THE HAZARD

Never operate on hills too steep for the ATV or for your abilities. Never operate the ATV on hills steeper than 25 degrees  $\angle 25^\circ$ .

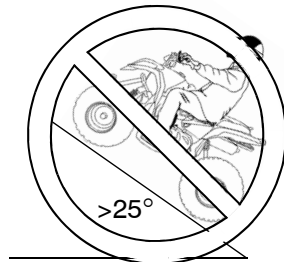

# Safety

## Operator Safety

### **WARNING**

#### POTENTIAL HAZARD

Climbing hills improperly.

#### WHAT CAN HAPPEN

Improper hill climbing could cause loss of control or overturn.

#### HOW TO AVOID THE HAZARD

Always follow proper procedures for climbing hills as described in the Owner's Manual beginning on page 82.

Always check the terrain carefully before ascending any hill.

Never operate the ATV on hills steeper than 25 degrees  $\angle 25^\circ$ .

Never climb hills with excessively slippery or loose surfaces.

Shift your weight forward. Never open the throttle suddenly while traveling uphill. The ATV could flip over backwards. Never go over the top of any hill at high speed. An obstacle, a sharp drop, or another vehicle or person could be on the other side of the hill.

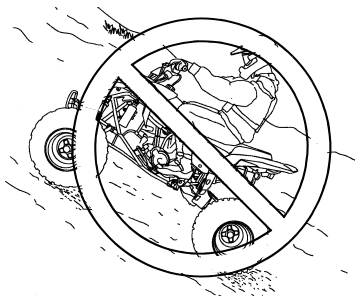

## Operator Safety

### **WARNING**

#### POTENTIAL HAZARD

Traveling downhill improperly.

#### WHAT CAN HAPPEN

Improperly descending a hill could cause loss of control or overturn.

#### HOW TO AVOID THE HAZARD

Always follow proper procedures for traveling down hills as described in the owner's manual. **NOTE:** A special technique is required when braking while traveling downhill. See page 88. Always check the terrain carefully before descending a hill. Shift your weight backward. Never travel down a hill at high speed. Avoid traveling down a hill at an angle, which would cause the vehicle to lean sharply to one side. Travel straight down the hill when possible.



# Safety

## Operator Safety

### **WARNING**

#### **POTENTIAL HAZARD**

Improperly crossing hills and turning on hills.

#### **WHAT CAN HAPPEN**

Improperly crossing or turning as hills could cause loss of control or overturn.

#### **HOW TO AVOID THE HAZARD**

Never try to turn the ATV around on any hill until you've mastered the turning technique (on level ground) as described in the owner's manual. See page 86. Use extra caution when turning on any hill. Avoid crossing the side of a steep hill.

When crossing the side of a hill:

Always follow proper procedures as described in the owner's manual. Avoid hills with excessively slippery or loose surfaces. Shift your weight to the uphill side of the ATV.



## Operator Safety

### **WARNING**

#### POTENTIAL HAZARD

Stalling, rolling backwards or improperly dismounting while climbing a hill.

#### WHAT CAN HAPPEN

The vehicle could overturn.

#### HOW TO AVOID THE HAZARD

Maintain steady speed when climbing a hill

*If all forward speed is lost:* Keep your weight uphill. Apply the front brakes gradually (right lever). When fully stopped, apply the foot brake as well and then lock the parking brake.

*If the ATV begins rolling backwards:* Keep weight uphill. Never apply engine power. Never apply the rear brake while rolling backwards. Apply the front brake slowly. When fully stopped, apply rear brake as well, and then lock the parking brake. Dismount on uphill side, or to either side if pointed straight uphill. Use the K-Turn to turn the ATV around and remount. See page 86.

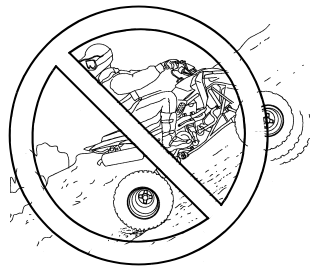

# Safety

## Operator Safety

### **WARNING**

#### POTENTIAL HAZARD

Skidding or sliding.

#### WHAT CAN HAPPEN

Skidding or sliding can cause loss of control.

If the tires regain traction unexpectedly, the ATV could overturn.

#### HOW TO AVOID THE HAZARD

On slippery surfaces such as ice, travel slowly and use extra caution to reduce the chance of skidding or sliding out of control.

### **WARNING**

#### POTENTIAL HAZARD

Improperly operating over obstacles.

#### WHAT CAN HAPPEN

Operating over obstacles could cause loss of control or overturn.

#### HOW TO AVOID THE HAZARD

Before operating in a new area, check for obstacles.

Avoid operating over large obstacles such as rocks and fallen trees when possible. If unavoidable, use extreme caution and always follow proper procedures as outlined in the owner's manual.

## Operator Safety

### **⚠ WARNING**

#### POTENTIAL HAZARD

Operating on frozen bodies of water.

#### WHAT CAN HAPPEN

Severe injury or death can result if the ATV and/or the operator fall through the ice.

#### HOW TO AVOID THE HAZARD

Never operate the ATV on a frozen body of water.

### **⚠ WARNING**

#### POTENTIAL HAZARD

Operating this ATV with improper tires, or with improper or uneven tire pressure.

#### WHAT CAN HAPPEN

Use of improper tires, or operation of the ATV with improper or uneven tire pressure, could cause loss of control or accident.

#### HOW TO AVOID THE HAZARD

Always use the size and type of tires specified for the ATV. Always maintain proper tire pressure as described in the owner's manual and on safety decals.



# Safety

## Operator Safety

### **WARNING**

#### POTENTIAL HAZARD

Operating the ATV through deep or fast-flowing water.

#### WHAT CAN HAPPEN

Tires may float, causing loss of traction and loss of control, which could lead to an accident or overturn.

#### HOW TO AVOID THE HAZARD

Avoid operating the ATV through deep or fast-flowing water. If it's unavoidable to enter water that exceeds the recommended maximum depth (see page 90), travel slowly, balance your weight carefully, avoid sudden movements, and maintain a slow and steady forward motion. Do not make sudden turns or stops, and do not make sudden throttle changes.

Wet brakes may have reduced stopping ability. Always test the brakes after leaving water. If necessary, apply them several times to let friction dry out the pads.

## Operator Safety

### **WARNING**

#### POTENTIAL HAZARD

Overloading the ATV or carrying/towing cargo.

#### WHAT CAN HAPPEN

Overloading or carrying/towing cargo can cause changes in vehicle handling, which could lead to loss of control or an accident.

#### HOW TO AVOID THE HAZARD

Never haul cargo or tow a load with this ATV.  
Never exceed the stated load capacity for this ATV.

### **WARNING**

#### POTENTIAL HAZARD

Operating the ATV with improper modifications.

#### WHAT CAN HAPPEN

Improper installation of accessories or modification of the ATV may cause changes in handling which could lead to an accident.

#### HOW TO AVOID THE HAZARD

Never modify the ATV through improper installation or use of accessories. All parts and accessories added to the vehicle must be genuine Polaris Industries Inc. or equivalent components designed for use on this ATV and should be installed and used according to approved instructions.

# Safety

## Operator Safety

### **WARNING**

Safe operation of this rider-active vehicle requires good judgement and physical skills. Persons with cognitive or physical disabilities who operate this vehicle have an increased risk of overturn and loss of control, which could result in severe injury or death.

### **WARNING**

Operating a damaged ATV can result in an accident with serious injury or death. After any overturn or accident, have a qualified service dealer inspect the entire machine for possible damage, including (but not limited to) brakes, throttle and steering systems.

## Operator Safety

### **WARNING**

Exhaust system components are very hot during and after use of the vehicle. Hot components can cause serious burns and fire. Do not touch hot exhaust system components. Always keep combustible materials away from the exhaust system. Use caution when traveling through tall grass, especially dry grass.

### **WARNING**

Leaving the keys in the ignition can lead to unauthorized use of the vehicle resulting in serious injury or death. Always remove the ignition key when the vehicle is not in use.

## Features and Controls

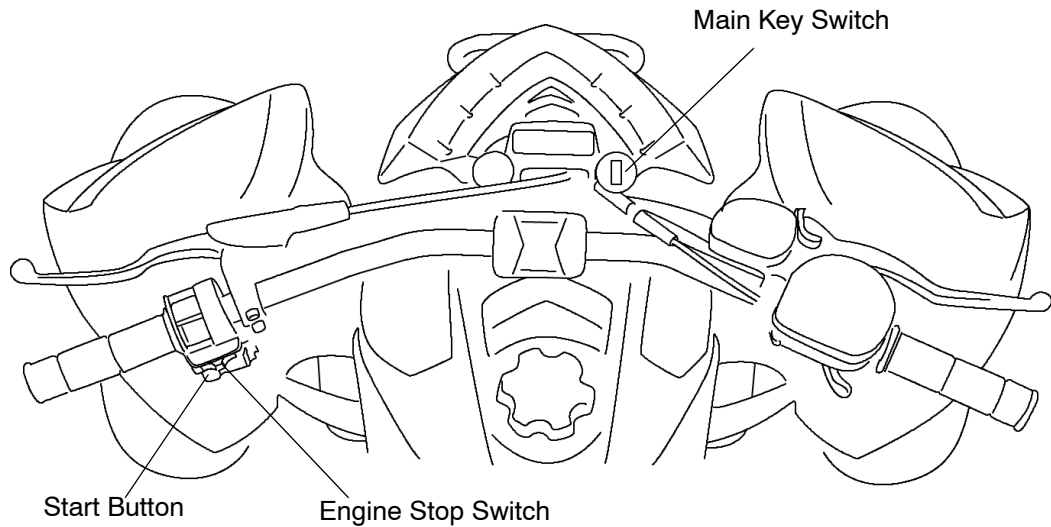

# Features and Controls

## Main Key Switch

The main key switch must be in the RUN position to start the engine. See page 75 for starting procedures.

## Start Button

Press the start button to engage the starter. Always release the start button promptly when the engine starts.

**NOTE:** If the starter fails to engage, replace the blown fuse or see your Polaris dealer.

## Engine Stop Switch

Move the stop switch either left or right to the OFF position to stop the engine quickly. The engine will not start or run when the switch is off.

**NOTE:** Both the main switch and the engine stop switch will shut off all electrical power to the vehicle, including lights.

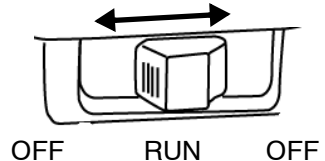

# Features and Controls

## Lights

### Indicator Lights

An illuminated light in the indicator window will alert you to the following conditions.

- Hot engine
- Reverse gear is selected
- Neutral gear is selected

**NOTE:** If indicator lights fail to operate, check connections. See your Polaris dealer for inspection of the capacitor and voltage regulator.

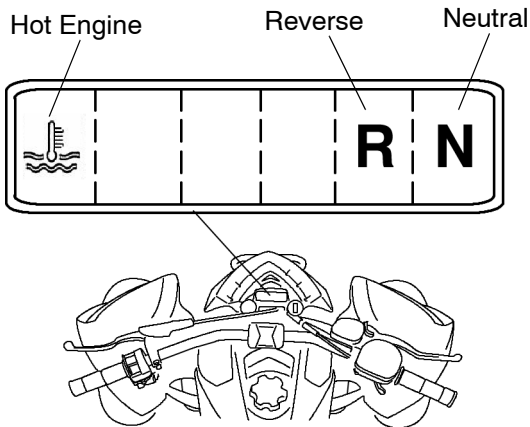

## Lights

### Headlights

#### **⚠ WARNING**

Operating the ATV on streets or roads, especially in darkness, could result in an accident and serious injury or death. This vehicle is not equipped with highway-approved lights. It's designed for and must be used for off-road use only. Use caution and drive at reduced speeds in conditions of reduced visibility such as fog, rain and darkness.

Use the light switch to turn the lights on and off and to switch the lights from high beam to low beam.

**NOTE:** The lights won't work unless the key is in the ON position and the engine stop switch is in the RUN position.

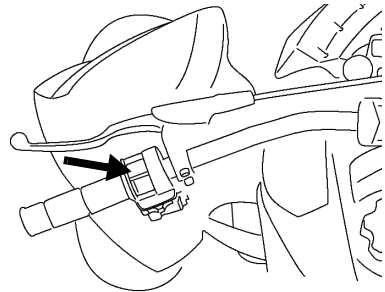



## Features and Controls

### Clutch Lever

The hydraulic clutch lever is located on the left handlebar. Squeeze the clutch lever toward the handlebar to disengage the clutch. Disengage the clutch before shifting gears.

The clutch is self-adjusting, but lever position can be changed to fit the operator's hand. Turn the adjusting knob counterclockwise to move the lever closer to the handlebar. Turn the adjusting knob clockwise to move the lever away from the handlebar.

**NOTE:** The adjustment range is limited. Never apply excessive force to the knob. Always turn the knob manually.

Always check the lever for smooth operation before riding. If the lever does not operate smoothly, check the fluid level at the master cylinder. See page 55.

If the lever begins to feel unresponsive, bleed the clutch system as outlined on page 152.

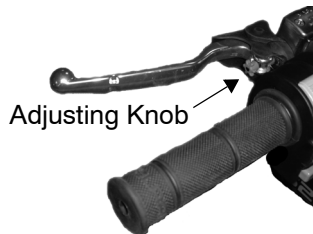

## Features and Controls

### Clutch Fluid

The clutch fluid master cylinder is located on the left handlebar. Check the fluid level in the reservoir before each ride. The level should be 4mm below the upper edge of the reservoir. Do not overfill.

Polaris recommends the use of KTM Hydraulic Clutch Oil. *Do not use brake fluid. Do not mix clutch fluid with any other hydraulic fluids.* See page 186 for the part numbers of Polaris products.

1. Position the vehicle on a level surface.
2. Turn the handlebar until the master cylinder is in a horizontal position.
3. Remove the two cover screws, the cover and the rubber boot.
4. Add the recommended fluid as needed.
5. Reinstall the cover, boot and screws securely.

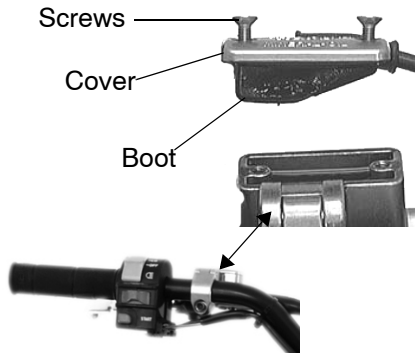

# Features and Controls

## Throttle Lever

### **⚠ WARNING**

Operating with sticking or improperly operating throttle controls could cause an accident and lead to severe injury or death. Never start or operate the vehicle with an improperly operating throttle. Always contact your dealer for service if throttle problems arise.

Failure to check or maintain proper operation of the throttle system can result in an accident if the throttle lever sticks during operation. Always check the lever for free movement and return before starting the engine. Also check occasionally during operation.

The throttle lever is located on the right handlebar. Squeeze the lever toward the handlebar to increase engine speed and vehicle movement. Engine speed returns to idle when the lever is released. See page 155 for throttle adjustment procedures.

**NOTE:** Fuel is injected into the intake passage each time throttle is applied. Do not squeeze the throttle lever while starting the engine. Do not squeeze the throttle lever when the engine is stopped.

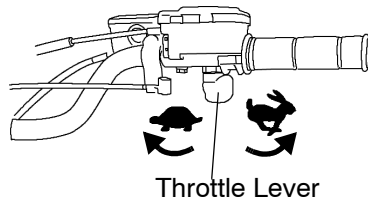

### Throttle Lever

This ATV is equipped with an Electronic Throttle Control (ETC), which is designed to reduce the risk of a frozen or stuck throttle. If the throttle cable should stick in an open position when the operator releases the throttle lever, the engine will stop.

#### **WARNING**

The Electronic Throttle Control (ETC) stops the engine in the event of a throttle system malfunction and is provided for your safety. Do not attempt to modify the ETC system or replace it with any after market throttle mechanism.

## Features and Controls

### Foot Brake

The foot brake operates the rear brakes. The brake pedal is located in front of the right-hand footpeg. If the rear wheels slide while using the foot brake, reduce brake pedal pressure to brake the wheels without skidding.

Check the brake fluid level frequently for the foot brake system. The reservoir is located under the seat. Maintain the fluid level between the minimum and maximum marks.

Check the rear brake light for proper operation before each use of the vehicle. See page 132.

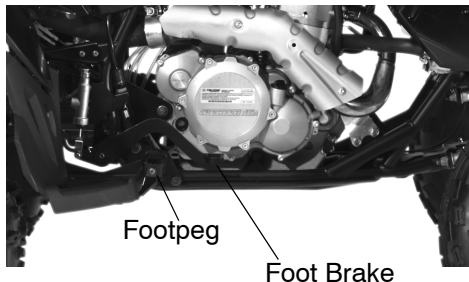

### **⚠ WARNING**

Aggressively applying the foot brake when backing down a hill may cause rear tipover, which could result in serious injury or death. Use caution when applying the foot brake. Do not aggressively apply the foot brake when going forward. The rear wheels may skid and slide sideways, causing loss of control and serious injury or death.

## Features and Controls

### Hand Brake

The hand brake operates the front brakes. The hand brake is located on the right handlebar.

Squeeze the brake lever toward the handlebar to engage the front brakes. These brakes are hydraulically activated disc type brakes.

Always test brake lever travel and master cylinder fluid level before riding. When squeezed, the lever should feel firm. Any sponginess would indicate a possible fluid leak or low master cylinder fluid level, which must be corrected before riding. Contact your dealer for proper diagnosis and repairs.

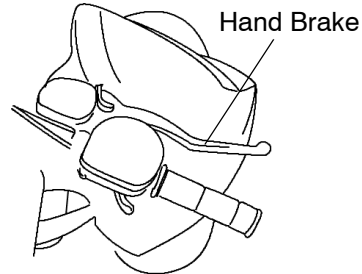

### **⚠ WARNING**

Operating the ATV with a spongy brake lever can result in loss of braking, which could cause an accident. Never operate the ATV with a spongy-feeling brake lever.

## Features and Controls

### Master Cylinder/Brake Fluid

Under normal operation, the diaphragm extends into the reservoir as fluid level drops. If the fluid level is low and the diaphragm is not extended, a leak is likely and the diaphragm should be replaced. Always fill the reservoir as needed whenever the cover is loosened or removed to ensure proper diaphragm operation. Do not overfill.

#### **WARNING**

An over-full master cylinder may cause brake drag or brake lock-up, which could result in serious injury or death. Maintain brake fluid at the recommended level. Do not overfill.

#### **WARNING**

Never store or use a partial bottle of brake fluid. Brake fluid is hygroscopic, meaning it rapidly absorbs moisture from the air. The moisture causes the boiling temperature of the brake fluid to drop, which can lead to early brake fade and the possibility of accident or severe injury. After opening a bottle of brake fluid, always discard any unused portion.

## Features and Controls

### Master Cylinder/Brake Fluid

Check the brake fluid in the master cylinder before each ride. If the fluid level is low add DOT 4 brake fluid only. Do not overfill. See page 186 for the part numbers of Polaris products.

**NOTE:** When checking the fluid level, the ATV must be on level ground with the handlebars straight.

### Hand Brake Fluid Level

View the fluid level through the indicator window on the side of the master cylinder. Maintain the fluid level at or slightly above the mark near the center of the sight glass. Do not overfill.

### Foot Brake Fluid Level

The brake fluid reservoir is located under the seat. Maintain the fluid level between the maximum and minimum marks.

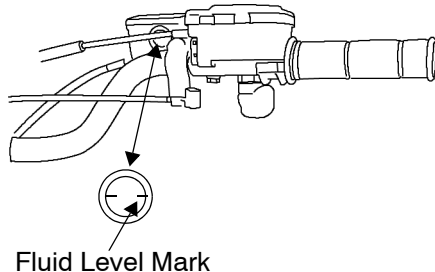



## Features and Controls

### Parking Brake

1. Place the transmission in first gear.
2. Squeeze and release the brake lever two or three times, then squeeze and hold.
3. Push the parking brake lock down to engage the lock. Release the brake lever.
4. To release the parking brake lock, squeeze and release the brake lever. The lock will automatically disengage.

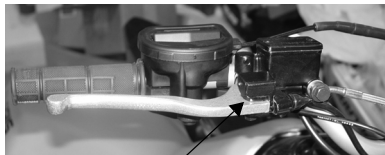

Locked

Unlocked



### **⚠ WARNING**

Operating the ATV while the parking brake is engaged could result in an accident and serious injury or death. Always check to be sure the parking brake is disengaged before operating.

# Features and Controls

## Parking Brake

### Important Safeguards

- The parking brake may relax if left on for a long period of time. Always block the wheels to prevent rolling.
- Always block the wheels on the downhill side of the ATV if leaving it parked on a hill. Another option is to park the ATV in a sidehill position.
- Never depend on the parking brake alone if the ATV is parked on a hill. Always block the wheels to prevent rolling.
- Place the transmission in first gear before locking the parking brake.

# Features and Controls

## Manual Shift

### Shift Pedal

The gear shift pedal is located in front of the left-hand footpeg. One full stroke of the pedal shifts the transmission to the next gear in the shifting sequence. The pedal automatically returns to a horizontal position when released.

To upshift to a higher gear, place the toe of your boot under the gear shift pedal and raise the pedal one full stroke.

To downshift, place your foot on the gear shift pedal and depress the pedal one full stroke. See page 65.

**NOTE:** To shift into reverse, see page 66.

### **WARNING**

Shifting without releasing the throttle and disengaging the clutch could cause loss of control or vehicle overturn. Always release the throttle and fully squeeze the clutch lever while shifting gears.

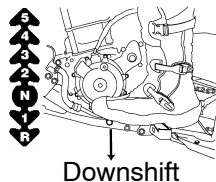
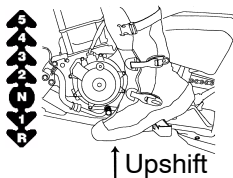

### Manual Shift Shifting Gears

**NOTE:** Always allow a cold engine to warm up before shifting gears.

1. When starting from a stopped position, place the transmission in neutral.
2. Squeeze and hold the brake lever.

**NOTE:** Do not squeeze the throttle lever.

3. Squeeze the clutch lever to disengage the clutch.
4. Depress the gear shift pedal one full stroke to shift into first gear.
5. Release the brake lever.
6. Gradually squeeze the throttle lever while slowly releasing the clutch lever.
7. As engine speed (RPM) increases in first gear, simultaneously release the throttle, disengage the clutch and shift to second gear by raising the gear shift pedal one full stroke. Repeat this procedure to progressively upshift to additional gears.
8. Use the same procedure to downshift.

# Features and Controls

## Manual Shift

### Reverse Lock-Out Switch

The reverse lock-out switch prevents the operator from shifting into reverse unintentionally.

1. Place the transmission in first gear. See page 64.
2. Push the lock-out lever forward toward the handlebar to unlock the transmission.
3. Shift down into reverse gear.

**NOTE:** The lock will automatically re-engage when the transmission is shifted out of reverse gear.

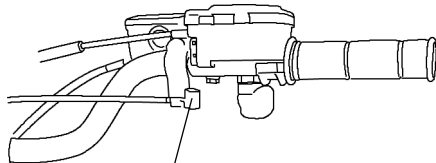

Lock-Out Lever

## Manual Shift

### Deceleration

To slow or stop the vehicle, release the throttle lever and apply the brakes smoothly and evenly. As the vehicle slows and engine RPM decreases, disengage the clutch and shift to a lower gear.

**NOTE:** Be sure the engine RPM has sufficiently decreased before shifting to a lower gear.

### **WARNING**

Improper use of the brakes, or shifting when the engine RPM is too high can cause the tires to lose traction or stop rotating, which could lead to loss of control, accident, and injury. It could also cause engine or drive train damage.

Make sure the engine RPM has sufficiently decreased before shifting to a lower gear.

## Features and Controls

### Choke

The choke assists in starting a cold engine. The choke knob is located on the left side of the carburetor. Refer to the engine starting procedure on page 75 for correct choke and throttle settings during starting.

### Fuel Tank

The fuel tank filler cap is located directly below the handlebar. Polaris recommends the use of 91 octane or higher fuel. *Do not use E-85 fuel.*

### Fuel Filter

The fuel valve has an internal fuel filter. Do not attempt to clean the fuel filter. See your Polaris dealer for service if you suspect the fuel filter is plugged.

Choke Knob



# Features and Controls

## Fuel Valve

The fuel valve is located on the left side of the ATV. It has three positions:

OFF: For vehicle storage and when transporting.

ON: For normal operation.

RES: For reserve supply if main supply is exhausted.

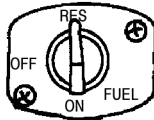
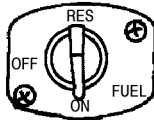
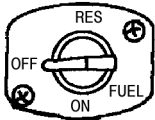

**NOTE:** There's about a 5 to 8 mile (8 to 13 km) range on reserve gas. Always refill the gas tank as soon as possible after using the main supply.

Always return the valve to the ON position after refueling.

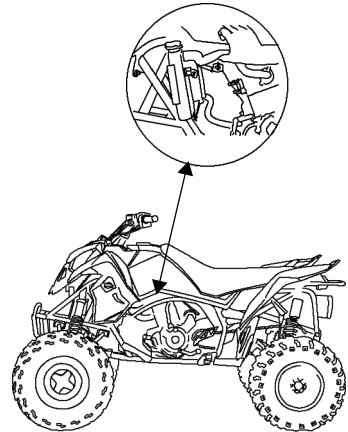



## Break-In Period

Careful treatment of a new engine and transmission will result in more efficient performance and longer life for both. The break-in period for your new Polaris ATV is the first three hours of operation, or the time it takes to use 5-6 gallons (20 liters) of fuel. Do not allow engine speed to exceed 7000 RPM during the break-in period. Follow the break-in period with an additional 12 hours of cautious operation, with engine speed below 75% of capacity.

No single action on your part is as important as following the procedures for a proper break-in. Perform the following break-in and maintenance procedures carefully.

### **CAUTION**

Excessive heat build-up during the first three hours of operation will damage close-fitted engine parts. Do not allow engine speed to exceed 7000 RPM during the first three hours of use.

Mixing brands or using a non-recommended oil may cause serious engine damage. Always use the recommended oil. Never substitute or mix oil brands.

## Break-In Period

1. Fill the fuel tank with gasoline. See page 74.
2. Check the oil level. Add the recommended oil as needed to maintain the oil level in the proper range. See page 109.
3. Allow the engine sufficient time to warm up before operating.
4. Drive slowly at first. Select an open area that allows room to familiarize yourself with vehicle operation and handling.
5. Vary throttle positions. Do not operate at sustained idle.
6. Perform regular checks on fluid levels, controls and areas outlined on the daily pre-ride inspection checklist. See page 72.
7. At the end of the break-in period (3 hours), change the engine oil and the long and short oil filters. See page 110. Clean the oil screen and drain plug magnet.

### CAUTION

Failure to perform the recommended break-in maintenance procedures can result in serious engine damage. Change the oil and filters after the first three hours of operation.

# Pre-Ride Inspection

## **WARNING**

If a proper inspection is not done before each use, severe injury or death could result. Always inspect the vehicle before each use to ensure it's in proper operating condition.

<b>Pre-Ride Checklist</b>		<b>Page</b>
Brake systems / lever travel	Ensure proper operation	58-63 156-157
Brake fluid	Ensure proper level	60
Clutch lever	Check for proper operation and adjustment	54
Clutch fluid	Ensure proper level	55
Suspension, front and rear	Inspect, lubricate if necessary	104
Steering	Check for free operation/loose components	--
Frame nuts, bolts, fasteners	Inspect, ensure tightness	--
Fuel and oil	Ensure proper levels	68, 109

## Pre-Ride Inspection

<b>Pre-Ride Checklist</b>		<b>Page</b>
Coolant (if applicable)	Ensure proper level	119
Coolant hoses (if applicable)	Inspect for leaks	--
Throttle	Ensure smooth operation	56
Indicator lights / switches	Ensure operation	52, 53
Engine stop switch	Ensure proper operation	51
Air filter	Inspect, clean, replace as needed	122
Air box sediment tubes	Drain deposits when visible	--
Headlamp	Check operation, apply Polaris dielectric grease to the socket when the lamp is replaced	129
Brake light / tail lamp	Check operation, adjust brake light switch	132
Riding gear	Wear helmet, goggles, protective clothing	12
A-arm ball joints	Check freeplay. If the tire moves excessively, do not operate. See your Polaris dealer.	--

## Operation

### Fuel System

#### **WARNING**

Gasoline is highly flammable and explosive under certain conditions.

- Always exercise extreme caution whenever handling gasoline.
- Always refuel with the engine stopped, and outdoors or in a well ventilated area.
- Do not smoke or allow open flames or sparks in or near the area where refueling is performed or where gasoline is stored.
- Do not overfill the tank. Do not fill the tank neck.
- If gasoline spills on your skin or clothing, immediately wash it off with soap and water and change clothing.
- Never start the engine or let it run in an enclosed area. Engine exhaust fumes are poisonous and can cause loss of consciousness or death in a short time.
- Turn the fuel valve off whenever the vehicle is stored or parked. See page 69.
- Make sure the vent line is in good condition and is routed properly.

## Starting the Engine

The engine can be started when the transmission is in neutral, or while in gear if the clutch is disengaged. If starting a warm engine, do not use the choke.

**NOTE:** Fuel is injected into the intake passage each time the throttle lever is depressed. Do not depress the throttle lever while starting the engine. Do not depress the throttle lever when the engine is stopped.

### **WARNING**

Engine exhaust contains poisonous carbon monoxide and can cause loss of consciousness resulting in severe injury or death. Never run an engine in an enclosed area.

### **CAUTION**

Operating the ATV immediately after starting could cause engine damage. Allow the engine to warm up for several minutes before operating.

# Operation

## Starting the Engine

1. Shift the transmission to neutral.
2. Lock the parking brake.
3. Turn the fuel valve on.
4. Sit on the vehicle.
5. Disengage the clutch.
6. If the engine is cold, pull the choke knob out until it stops. Do not use the choke if starting a warm engine.
7. Move the engine stop switch to the RUN position.
8. Turn the ignition key to ON.

Choke Knob

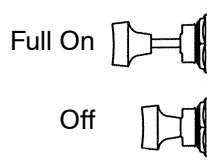
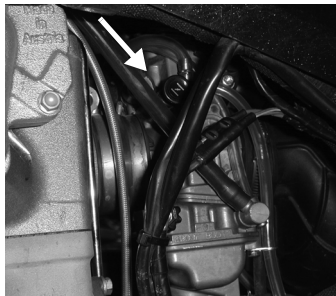

## Starting the Engine

**NOTE:** If starting the engine while in gear, apply the hand brake and squeeze the clutch lever fully to disengage the clutch. If starting the engine while in neutral, the neutral indicator light should be on. If it isn't, disengage the clutch and shift the foot pedal to find neutral. See page 64.

9. Press the start button to start the engine. Activate the starter for a maximum of five seconds. Release the start button immediately when the engine starts.

**NOTE:** Fuel is injected into the intake passage each time the throttle lever is depressed. Do not depress the throttle lever while starting the engine. Do not depress the throttle lever when the engine is stopped.

**NOTE:** Excessive engagement may result in starter damage.

10. If the engine does not start, wait five seconds after releasing the start button, then activate the starter for another five seconds. Repeat until the engine starts.

**NOTE:** If the engine does not start, review the engine troubleshooting information beginning on page 188. If all conditions are favorable and the engine still does not start, see your Polaris dealer for service.

11. Push the choke knob completely in.
12. Vary engine speed slightly with the throttle to aid in warm-up.



# Operation

## Driving Procedure

1. Sit upright with both feet on the footpegs and both hands on the handlebars.
2. Start the engine and allow it to warm up.
3. Shift the transmission into gear. See page 64.
4. Check your surroundings and determine your path of travel.
5. Release the parking brake.
6. Slowly depress the throttle with your right thumb while slowly releasing the clutch lever to begin driving.
7. Drive slowly. Practice maneuvering and using the throttle, clutch and brakes on level surfaces.



## Making Turns

Practice making turns at slow speeds before attempting to turn at faster speeds.

### **⚠ WARNING**

Turning at sharp angles or at excessive speeds can result in vehicle overturn and lead to serious injury or death. Avoid turning at sharp angles. Never turn at high speeds.

Your ATV is equipped with a solid rear axle, which drives both rear wheels equally at all times. The wheel on the outside of the turn travels a greater distance than the inside wheel when turning, and the inside tire slips traction slightly.

To turn, steer in the direction of the turn, leaning your upper body to the inside of the turn while supporting your weight on the outer footpeg. This technique alters the balance of traction between the rear wheels, allowing the turn to be made smoothly.

The same leaning technique should be used for turning in reverse.

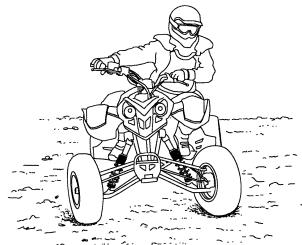

## Operation

### Driving on Slippery Surfaces

#### **WARNING**

Failure to exercise care when operating on slippery surfaces can result in loss of tire traction and cause loss of control, accident, and serious injury or death.

Never apply the brakes during a skid.

Do not operate on excessively slippery surfaces.

Always reduce speed and use additional caution, especially when downshifting.

## Driving on Slippery Surfaces

Whenever riding on slippery surfaces such as wet trails or loose gravel, or during freezing weather, follow these precautions:

1. Slow down when entering slippery areas.
2. Maintain a high level of alertness, reading the trail and avoiding quick, sharp turns, which can cause skids.
3. Correct a skid by turning the handlebars in the direction of the skid and shifting your body weight forward.



## Operation

### Driving Uphill

#### **WARNING**

Braking and handling are greatly affected when operating in hilly terrain. Improper procedure could cause loss of control or overturn and result in serious injury or death.

Avoid climbing steep hills (25° maximum).

Use extreme caution when operating on hills, and follow proper operating procedures outlined in the owner's manual.

## Driving Uphill

Whenever traveling uphill, follow these precautions:

1. Always travel straight uphill.
2. Avoid steep hills (25° maximum).
3. Keep both feet on the footpegs.
4. Transfer your weight forward.
5. Proceed at a steady rate of speed and throttle opening.
6. Remain alert and be prepared to take emergency action. This may include quick dismounting of the vehicle.

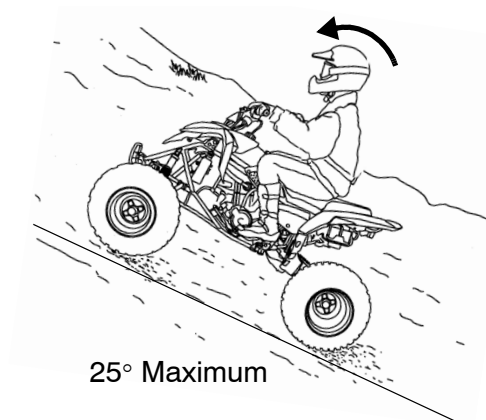

## Operation

### Driving Across Hillsides

#### **WARNING**

Improperly crossing hills or turning on hills can result in loss of control or vehicle overturn, resulting in severe injury or death. Avoid crossing the side of a hill when possible. Follow proper procedures as outlined in the owner's manual.

## Driving Across Hillside

If you enter into a situation where sidehilling is unavoidable, follow these precautions:

1. Slow down.
2. Lean into the hill, transferring your upper body weight uphill while keeping your feet on the footpegs.
3. Steer slightly into the hill to maintain direction.

**NOTE:** If the vehicle begins to tip, quickly turn the front wheels downhill, if possible, or dismount on the uphill side *immediately!*

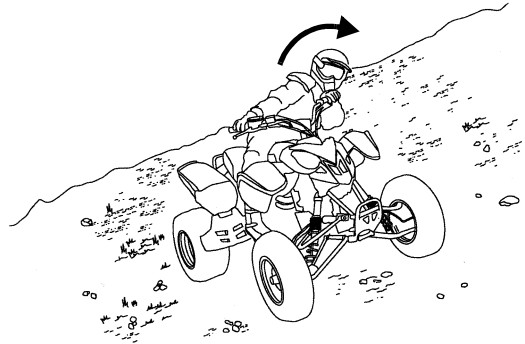



## Operation

### Turning Around on a Hill

#### **WARNING**

Improper hill climbing procedures could cause loss of control or overturn and result in serious injury or death. Avoid climbing steep hills (25° maximum). Use extreme caution when operating on hills, and follow proper operating procedures outlined in the owner's manual.

If the vehicle stalls while climbing a hill, never back it down the hill! One maneuver that can be used when it's necessary to turn around while climbing a hill is the K-turn:

1. Keep your body weight uphill.
2. Pull in the clutch lever and apply the front and rear brakes.
3. When completely stopped, shut off the engine. Leaving the transmission in gear, release the clutch lever and lock the parking brake.
4. Dismount on the uphill side of the vehicle, or on the left side if the vehicle is pointing straight uphill.
5. Staying uphill of the ATV, turn the handlebars full left.

## Turning Around on a Hill

6. Reach across the handlebar and apply the front brakes to unlock the parking brake.
7. With the front brakes applied, pull in the clutch lever. Use the brakes to slowly allow the vehicle to roll around to your right until it's pointing across the hill or slightly downward.
8. With the front brakes still applied, release the clutch lever and lock the parking brake. Remount from the uphill side, keeping body weight uphill.
9. Pull in the clutch lever, shift into neutral and restart the engine.
10. Release the parking brake and slowly release the clutch lever, allowing the ATV to proceed slowly. Stay in first gear, using the brakes for additional speed control if necessary, until more level ground is reached. Do not apply the brakes abruptly when driving downhill.

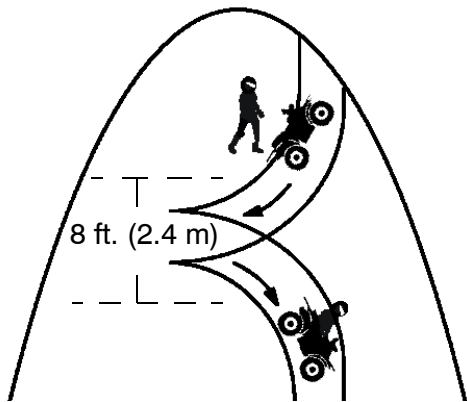

## Operation

### Driving Downhill

Whenever descending a hill, follow these precautions:

1. Drive directly downhill.
2. Transfer your weight to the rear of the vehicle.
3. Slow down.
4. Shift to the lowest gear possible while maintaining a safe speed.
5. Apply the foot brake *slightly* to aid in slowing.

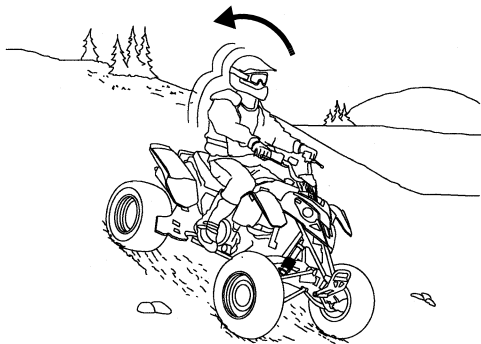

### **⚠ WARNING**

Excessive speed can cause loss of control and lead to serious injury or death. Always operate slowly when traveling downhill.

## Parking on a Hill or Incline

Avoid parking on a hill or incline if possible. If it's unavoidable, follow these precautions:

1. Turn the engine off.
2. Place the transmission in first gear.
3. Lock the parking brake.
4. Always block the rear wheels on the downhill side. See illustration.
5. Turn the fuel valve off.

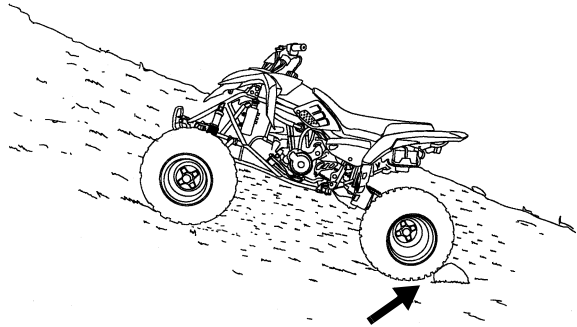

# Operation

## Driving Through Water

Your ATV can operate through water with a maximum recommended depth equal to the level of the footpegs. Follow these procedures when operating through water:

1. Determine water depths and current before crossing.
2. Choose a crossing where both banks have gradual inclines.
3. Proceed slowly, avoiding rocks and obstacles if possible.
4. After driving through water, dry the brakes by applying light pressure to the lever (while moving) until braking action is normal. If you do not perform this procedure, your brakes may be ineffective.



Maximum Depth

### Driving Through Water

Avoid operating your ATV through deep or fast flowing water. If the ATV is operated in deeper water than recommended, it's critical to have it serviced as outlined in the maintenance chart beginning on page 97. Engine oil and all grease fittings need special attention.

#### CAUTION

Major engine damage can result if the vehicle is not thoroughly inspected after operation in water. Perform the services outlined in the maintenance chart. If your vehicle becomes immersed or is operated in water that exceeds the footpeg level, take it to your dealer for service before starting the engine.

**NOTE:** Avoid operating the vehicle through deep or fast-flowing water. If you cannot avoid water that exceeds the recommended maximum depth, go slowly, balance your weight carefully, avoid sudden movements, and maintain a slow and steady forward motion. Do not make sudden turns or stops, and do not make sudden throttle changes.

If your vehicle becomes immersed, and it's impossible to take it to a dealer before starting it, follow the steps described on page 140. Have the vehicle serviced by your dealer at the first opportunity.

## Operation

### Driving in Reverse

Follow these guidelines when operating in reverse:

1. Back slowly.
2. Apply the brakes *lightly* for stopping.
3. Avoid turning at sharp angles.
4. Always avoid backing downhill.
5. Never open the throttle suddenly while backing.
6. Always look left, right and behind the ATV before backing.

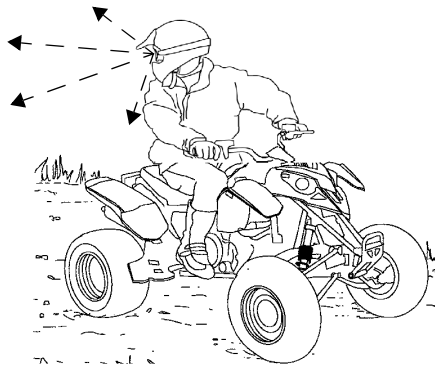

## Driving in Reverse

### **WARNING**

Failure to use caution when operating in reverse can result in serious injury or death. Before shifting into reverse, always check for obstacles or people behind the vehicle. Follow the reverse operation procedures outlined in this manual.

This Polaris ATV is equipped with a reverse speed limiter. Do not operate at full throttle. Use just enough throttle to maintain a desired speed.

### **CAUTION**

Excessive throttle operation while in the speed limit mode may cause fuel to build in the exhaust, resulting in engine popping and/or engine damage.



## Operation

### Driving Over Obstacles

Be alert! Look ahead and learn to read the terrain you're traveling on. Be constantly alert for hazards such as logs, rocks and low hanging branches.

#### **⚠ WARNING**

Severe injury or death can result if your vehicle comes in contact with a hidden obstacle. Not all obstacles are immediately visible. Travel with caution in unfamiliar terrain.

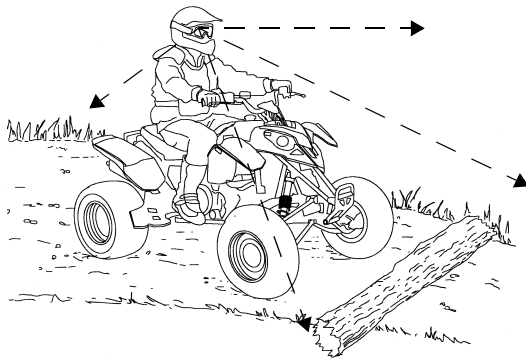

# Emission Control Systems

## Noise Emission Control System

Do not modify the engine, intake or exhaust components, as doing so may affect compliance with U.S.A. EPA noise control requirements (40 CFR 205) and local noise level requirements.

## Operation on Public Lands in the U.S.A.

Your Polaris vehicle has a spark arrestor that was tested and qualified to be in accordance with the USDA Forest Service Standard 5100-1C. Federal law requires that this spark arrestor be installed and functional when the vehicle is operated on public lands.

Operation of off-road vehicles on public lands in the U.S.A. is regulated by 43 CFR 8343. Violations are subject to monetary penalties. Federal regulations can be viewed online at [www.gpoaccess.gov/ecfr/](http://www.gpoaccess.gov/ecfr/).

## Electromagnetic Interference

This spark ignition system complies with Canadian ICES-002.

This vehicle complies with European directives 97/24/EC and 89/336/EEC.

# **Emission Control Systems**

## **Crankcase Emission Control System**

This engine is equipped with a closed crankcase system. Blow-by gases are forced back to the combustion chamber by the intake system. All exhaust gases exit through the exhaust system.

## **Exhaust Emission Control System**

The emissions from the exhaust of this vehicle are controlled by engine design, including factory-set fuel delivery and ignition. The engine and related components must be maintained at Polaris specifications to achieve optimal performance.

Engine idle speed is the only adjustment Polaris recommends that the operator perform. Any other adjustments should be performed by an authorized Polaris dealer.

The emissions label is located on the front frame tube near the steering post.

## Periodic Maintenance Chart

Routine inspection and service are critical to the performance and reliability of your high performance engine. Failure to perform the recommended maintenance procedures outlined in the Periodic Maintenance Chart will result in forfeited warranty coverage as well as decreased performance and reliability of the vehicle.

The recommended service intervals are based on average riding conditions. Vehicles subjected to severe use must be inspected and serviced more frequently.

### Severe Use Definition

- Frequent immersion in mud, water or sand
- Racing or race-style high RPM use
- Prolonged low speed, heavy load operation
- Extended idle
- Short trip cold weather operation

# Maintenance

## Periodic Maintenance Chart

Inspect, clean, lubricate, adjust and replace parts as necessary. When inspection reveals the need for replacement parts, use genuine Polaris parts available from your Polaris dealer. Record maintenance and service in the Maintenance Log beginning on page 209.

**NOTE:** Service and adjustments are critical. If you're unable to perform the required service and adjustment procedures, have a qualified dealer perform these operations.

## Periodic Maintenance Chart

### **WARNING**

Improperly performing the procedures marked with a ■ could result in component failure and lead to serious injury or death. Have an authorized Polaris dealer perform these services.

### **Maintenance Chart Key**

- ▶ Perform these operations more often under severe use.
- E** Emission-related service (Failure to conduct this maintenance will not void the emissions warranty but may affect emissions.)
- Have an authorized Polaris dealer perform these services.
- Use Polaris Premium All Season Grease or grease conforming to NLGI No. 2.

# Maintenance

## Periodic Maintenance Chart

Item		Maintenance Interval (whichever comes first)			Remarks	See Page
		Hours	Calendar	Fuel Used		
	Brake systems/brake fluid	--	Pre-ride	--	Check each day before operating the vehicle. Make adjustments as needed. See the Pre-Ride Checklist.	72
	Tires	--		--		
	Wheels/lug nuts	--		--		
	Frame fasteners	--		--		
	Coolant	--		--		
	Fuel	--		--		
	Engine oil	--		--		
	Transmission oil	--		--		
	Throttle	--		--		
	Clutch system/clutch fluid	--		--		
	Lights	--		--		
	Engine stop switch	--		--		
	Steering	--		--		

# Maintenance

## Periodic Maintenance Chart

Item		Maintenance Interval (whichever comes first)			Remarks	See Page
		Hours	Calendar	Fuel Used in gallons (liters)		
	Air box sediment tubes	--	Pre-ride	--	Check each day before operating the vehicle. Make adjustments as needed. See the Pre-Ride Checklist.	72
	Headlamp	--		--		
	Tail lamp/brake lamp	--		--		
	A-arm ball joint	--		--		
	Rear shaft assembly	--		--		
	Oil and filter change	3	Break-in	5 (20)	Change the oil and filters	110
	Oil screen/drain plug				Clean screen and plug magnet	112
	Idle speed				Check idle speed setting	123
	Engine mounting bolts				Check torque	--
<b>E</b>	Valve clearance				Check; adjust	--

- ▶ Perform these procedures more often for vehicles subjected to severe use
- E** Emission-Related Service
- Have an authorized Polaris dealer perform these services
- Use Polaris Premium All Season Grease



# Maintenance

## Periodic Maintenance Chart

Item		Maintenance Interval (whichever comes first)			Remarks	See Page
		Hours	Calendar	Fuel Used in gallons (liters)		
	Brake pad wear	10	Monthly	--	Inspect regularly	157
	Battery	10	Monthly	--	Check terminals; clean; test	143
▶E	Air filter	15	Weekly	--	Inspect; clean; replace as needed	122
▶	Oil and filter change	15	6 M	26 (100)	Perform initial oil change after first 3 hours of operation.	110
▶	Oil screen/drain plug	15	6 M	26 (100)	Clean screen and plug magnet	112
	Idle speed	15	6 M	26 (100)	Check; adjust as needed	123
	Engine mounting bolts	15	6 M	26 (100)	Check torque	--
	Shift lever bolt	15	6 M	26 (100)	Check torque	--
E	Valve clearance	15	6 M	26 (100)	Check; adjust	--
	Clutches	30	6 M	52 (200)	Check discs for wear	--
E	Spark plug	30	6 M	52 (200)	Replace	135

# Maintenance

## Periodic Maintenance Chart

Item		Maintenance Interval (whichever comes first)			Remarks	See Page
		Hours	Calendar	Fuel Used in gallons (liters)		
▶●	General lubrication	45	3 M	78 (300)	Lubricate all fittings, pivots, cables, etc.	--
	Carburetor float bowl	45	6 M	78 (300)	Drain bowl periodically and prior to storage	125
■E	Throttle cable/ETC switch	45	6 M	78 (300)	Inspect; adjust; replace as needed	155
▶	Drive chain(s)	45	6 M	78 (300)	Inspect daily; adjust; lubricate if needed	160
▶■	Brake pad replacement	45	6 M	78 (300)	See your Polaris dealer	--
	Coolant strength	45	6 M	78 (300)	Inspect strength seasonally	118

- ▶ Perform these procedures more often for vehicles subjected to severe use
- E Emission-Related Service
- Have an authorized Polaris dealer perform these services
- Use Polaris Premium All Season Grease

# Maintenance

## Periodic Maintenance Chart

Item		Maintenance Interval (whichever comes first)			Remarks
		Hours	Calendar	Fuel Used in gallons (liters)	
▶●	Upper steering post (1)	45	6 M	--	Inspect; tighten fasteners; grease after washing ATV/driving in water
▶●	Front A-Arms (2)	45	6 M	--	Inspect; tighten fasteners; grease (also after washing ATV or driving in water)
▶●	Rear axle/eccentric (3)	30	3 M	--	

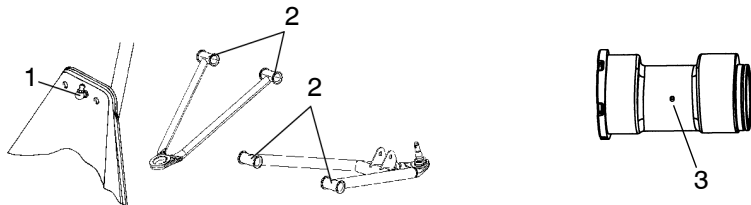

# Maintenance

## Periodic Maintenance Chart

Item		Maintenance Interval (whichever comes first)			Remarks	See Page
		Hours	Calendar	Fuel Used in gallons (liters)		
	Clutch springs	60	12 M	104 (400)	Check spring length (see dealer)	--
	Cam chain tensioner	60	12 M	104 (400)	Check ratchet teeth for wear	--
	Coolant system	90	12 M	156 (600)	Pressure test system annually	--
▶	Cooling system hoses	90	12 M	156 (600)	Inspect	--
	Radiator	90	12 M	156 (600)	Inspect; clean external surface; change coolant every 2 years	--
■E	Fuel system	90	12 M	156 (600)	Check for leaks at tank cap, lines, fuel valve, filter, carburetor; replace lines every two years	--
E	Cylinder and piston	90	--	156 (600)	Inspect; measure; replace as needed	--
	Piston pin circlip groove	90	--	156 (600)	Visual inspection for wear	--

- ▶ Perform these procedures more often for vehicles subjected to severe use
- E Emission-Related Service
- Have an authorized Polaris dealer perform these services
- Use Polaris Premium All Season Grease

# Maintenance

## Periodic Maintenance Chart

Item		Maintenance Interval (whichever comes first)			Remarks
		Hours	Calendar	Fuel Used in gallons (liters)	
E	Compression ring	90	--	156 (600)	See your dealer or refer to the Dealer Service Manual; measure ring gap and replace if at or below service limit
E	Oil scraper ring	90	--	156 (600)	
	Camshaft	90	--	156 (600)	Visual inspection for wear
	Valve spring cap	90	--	156 (600)	Visual inspection for wear
E	Camshaft bearings	90	--	156 (600)	Replace
E	Valve springs	90	--	156 (600)	See your dealer or refer to the Dealer Service Manual; perform measurements; replace as needed
E	Valve seats/guides	90	--	156 (600)	
E	Rocker arm rollers	90	--	156 (600)	
E	Timing chain	90	--	156 (600)	Measure elongation; replace as needed
	Cam chain tensioner	90	--	156 (600)	Check ratchet teeth for wear
E	Bearings (connecting rod, balance shaft, crankshaft main)	90	--	156 (600)	Replace
	Crankshaft run-out	90	--	156 (600)	Measure; adjust as needed

# Maintenance

## Periodic Maintenance Chart

Item		Maintenance Interval (whichever comes first)			Remarks	See Page
		Hours	Calendar	Fuel Used in gallons (liters)		
	Oil pressure valve	90	--	156 (600)	Measure spring; replace as needed	
	Transmission	90	--	156 (600)	Check entire transmission/bearings for wear; replace as needed	
■E	Ignition Timing	--	12 M	--	Inspect; adjust as needed	
	Clutch fluid	90	12 M	--	Bleed as needed; change yearly	152
■E	Jet needle/needle jet	180	24 M	--	Replace	
■	Brake fluid	180	24 M	--	Replace	
	Spark arrestor	300	36 M	--	Clean out	138
■	Front/rear wheel bearings	300	36 M	--	Inspect; replace as needed	
■	Toe adjustment	As required			Inspect periodically; adjust when parts are replaced	158
	Headlight aim	As required			Adjust as needed	128

- ▶ Perform these procedures more often for vehicles subjected to severe use
- E Emission-Related Service
- Have an authorized Polaris dealer perform these services
- Use Polaris Premium All Season Grease

## Maintenance

### Engine Oil Recommendations

Always check and change the engine oil at the intervals outlined in the Periodic Maintenance Chart beginning on page 97. Polaris recommends the use of Polaris PS-4 *PLUS Performance* Synthetic 2W-50 4-cycle oil or a similar oil designed for use in 4-stroke manual clutch ATV and motorcycle applications. See page 186 for the part numbers of Polaris products.

**NOTE:** Do not use Polaris PS-4 *Performance* Synthetic 10W-40 Oil. Always use 2W-50.

### CAUTION

Mixing brands or using a non-recommended oil may cause serious engine damage. Always use the recommended oil. Never mix oil brands.

**NOTE:** If the ATV is used year-round, check the oil level frequently. A rising oil level could indicate the accumulation of contaminants such as water or excess fuel in the bottom of the crankcase. Water in the bottom of the crankcase can lead to engine damage and must be drained. Change the oil immediately if the oil level rises.

### Engine Oil Level

Check the oil level before each use of the vehicle. If the engine is cold, the oil level should be visible at the lower edge of the sight glass. If the engine is warm, the oil level should be visible between the 1/2 and 3/4 levels in the sight glass.

1. Position the vehicle on a level surface.
2. View the oil level through the sight glass on the right side of the vehicle.
3. Remove the fill plug and add the recommended oil as needed.
4. Reinstall the fill plug.

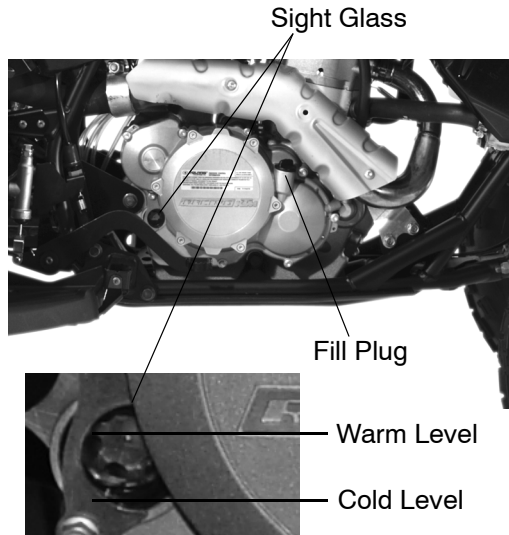



## Maintenance

### Engine Oil Change

#### CAUTION

If the ATV is left without oil in the system for extended periods, the oil pump may lose its prime, which could result in engine damage. Do not allow the vehicle to be without oil and filter overnight. Always replace the oil and filters within a few hours of draining the oil.

Always change the oil at the intervals outlined in the Periodic Maintenance Chart beginning on page 97. Perform the initial break-in oil change after the first three hours of operation. Always change both oil filters and clean the oil screens whenever changing oil.

**NOTE:** Change the oil more frequently on vehicles subjected to severe use.

## Engine Oil Change

1. Position the vehicle on a level surface.
2. Start the engine. Allow it to idle for two to three minutes. Stop the engine.
3. Place a drain pan beneath the crankcase. Remove the drain plug. Allow the oil to drain completely.

### **⚠ CAUTION**

Hot oil can cause serious burns to skin. Do not allow hot oil to contact skin.

4. Clean the crankcase sealing surface and the drain plug (with magnet) thoroughly.
5. Replace the sealing ring. Reinstall the drain plug. Torque to 15 ft. lbs. (20 Nm).

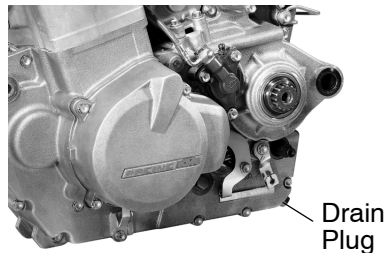

# Maintenance

## Engine Oil Change

### Cleaning the Short Oil Screen

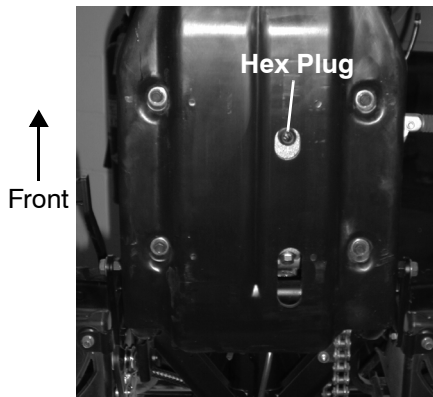

View from bottom of vehicle

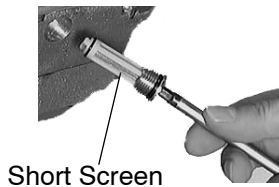

### Engine Oil Change

#### Cleaning the Short Oil Screen

1. Insert a hex key into the plug at the bottom of the engine. See illustration on preceding page.
2. Using a hammer, tap lightly on the key a few times to loosen the seal. Remove the plug.
3. Remove the short oil screen. Clean the screen components thoroughly and blow well with compressed air.
4. Check the O-rings. If damaged, install new O-rings.
5. Reinstall the screen to the plug.
6. Lubricate the threads and reinstall the plug. Torque to 7.5 ft. lbs. (10 Nm).

# Maintenance

## Engine Oil Change

### Cleaning the Long Oil Screen

1. Remove the long screen plug, located on the side of the engine near the engine number.
2. Remove the oil screen. Clean the screen thoroughly and blow with compressed air.
3. Check the O-rings. If damaged, install new O-rings.
4. Place the long oil screen on a pin-type key or similar tool of about 12 inches (300 mm) in length.

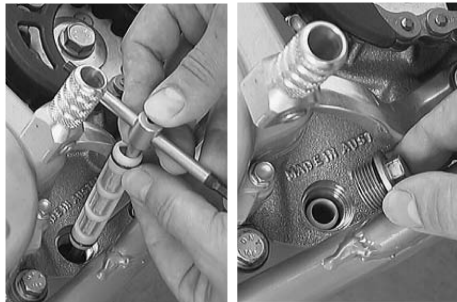
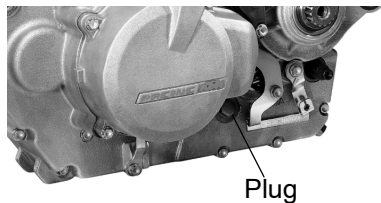

## Engine Oil Change

### Cleaning the Long Oil Screen

#### CAUTION

An improperly installed oil screen will function poorly and result in increased engine wear. Install the screen securely at the angle shown in the illustration.

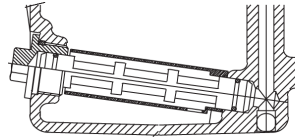

5. Insert the tool through the opening and into the bore of the opposite engine casing wall. Push the oil screen into the casing as far as possible. Remove the tool.
6. Reinstall the plug. Torque to 11 ft. lbs. (15 Nm).

# Maintenance

## Engine Oil Change

### Changing Oil Filters

1. Place a drain pan under the engine.
2. Remove the four oil filter cover screws (1). Remove the covers.
3. Using circle clip (snap ring) pliers, pull the oil filter inserts (2) out of the housing.
4. Thoroughly clean the engine casing, filter covers and sealing surfaces of the O-rings. Check the O-rings. If damaged, install new O-rings.
5. Fill each oil filter with oil. Install the long filter at the front of the filter box. Install the short filter at the rear of the box.

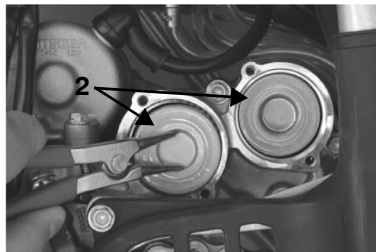
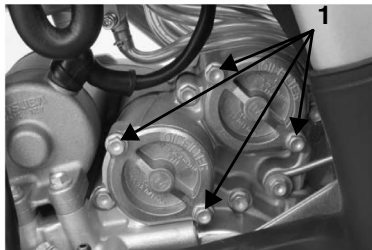

## Engine Oil Change

### Changing Oil Filters

- Grease the filter cover O-rings (3).
- Reinstall the covers and the screws. Tighten screws to 4.5 ft. lbs. (6 Nm).
- Remove the oil fill plug (4). Add 40 oz. (1.2 liters) of the recommended engine oil (see page 108). Reinstall the fill plug.
- Start the engine. Allow it to idle for at least one minute to fully distribute the new oil. Stop the engine.
- Check for leaks at all threaded connections and at the oil filter covers.
- View the oil level in the sight glass. Add oil as needed to maintain the level as recommended (see page 109).

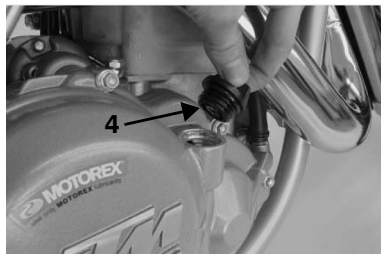



## Maintenance

### Engine Cooling System

The engine coolant level is controlled or maintained by the recovery system. The recovery system components are the recovery bottle, radiator filler neck, radiator pressure cap and connecting hose.

To ensure that the coolant maintains its ability to protect the engine, we recommend that you completely drain the cooling system every two years and add a fresh mixture of antifreeze and water.

Polaris recommends the use of Polaris Premium 60/40 anti-freeze/coolant or a 50/50 mixture of high quality aluminum compatible anti-freeze/coolant and distilled water. See page 186 for the part numbers of Polaris products.

**NOTE:** Polaris Premium 60/40 is already premixed and ready to use. Do not dilute with water.

**NOTE:** Always follow the manufacturer's mixing recommendations for the freeze protection required in your area.

### Engine Cooling System

#### Coolant Level

The recovery bottle is located on the right side of the vehicle under the front fender. The fluid level must be maintained between the FULL and ADD marks on the side panel (when the fluid is cool).

As coolant operating temperature increases, the expanding (heated) excess coolant is forced out of the radiator, past the pressure cap, and into the recovery bottle. As engine coolant temperature decreases, the contracting (cooled) coolant is drawn back up from the tank, past the pressure cap, and into the radiator.

**NOTE:** Some coolant level drop on new machines is normal, as the system is purging itself of trapped air. Observe coolant levels and maintain as recommended by adding coolant to the recovery bottle.

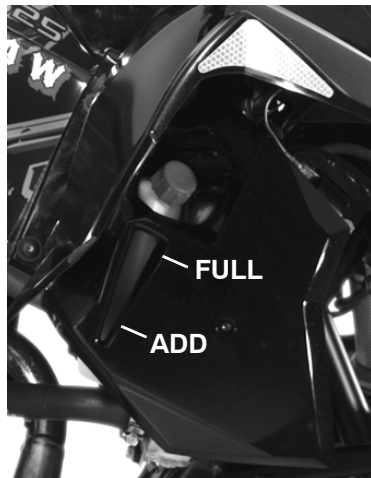

# Maintenance

## Engine Cooling System

### **⚠ WARNING**

Escaping steam can cause severe burns. Never remove the pressure cap while the engine is warm or hot. Always allow the engine to cool before removing the cap.

### **Radiator Coolant Level**

If the recovery bottle has run dry, inspect the level in the radiator and add coolant if necessary. The radiator pressure cap is located on the left side of the vehicle.

1. Remove the pressure cap.
2. Using a funnel, slowly add coolant as necessary through the radiator filler neck.
3. Reinstall the pressure cap.

**NOTE:** Use of a non-standard pressure cap will not allow the recovery system to function properly. Contact your dealer for the correct replacement part.



### Engine Cooling System

#### Cooling System Bleeding

Bleeding the cooling system is required only if the system has been drained for maintenance and/or repair. Always allow the engine to cool sufficiently before removing the radiator pressure cap.

1. Remove the pressure cap.
2. Using a funnel, slowly add the recommended coolant. Fill the radiator to the bottom of the filler neck.
3. Reinstall the pressure cap.
4. Start the engine and allow it to idle for five minutes, or until operating temperature is reached.
5. Stop the engine.
6. After the engine has cooled, add additional coolant to refill the radiator to the bottom of the filler neck.
7. Operate the vehicle for 20 minutes, allow the engine to cool, then recheck the coolant level in the radiator. Add coolant as needed.

# Maintenance

## Air Filter Systems

1. Remove the seat.
2. Release the airbox cover clips and remove the cover.
3. Remove the wing nuts securing the filter to the airbox.
4. Pull the filter assembly out of the air box. Note the placement of the rubber ring for reinstallation.
5. Wash the filter in soapy water, then rinse and let dry.
6. Apply a commercially available foam filter lubricant to the foam filter.
7. Reinstall the rubber ring properly to the filter assembly, and reinstall the filter into the air box.
8. Secure the wing nuts and reinstall the air box cover.
9. Check the boots for cracks, deterioration, abrasion, or leaks. Replace as needed.

### **Carburetor**

Normal wear from engine vibrations may cause the carburetor to supply an overly rich fuel mixture. Replace the jet needle and the needle jet after every 180 hours of operation.

### **Idle Speed**

Carburetor idle adjustments affect engine starting behavior. A proper idle speed of 1700-1800 RPM will result in easier starting. If idle speed is unsatisfactory, make adjustments as outlined on page 124.

# Maintenance

## Carburetor

### Idle Speed

1. Position the vehicle on a level surface.
2. Lock the parking brake. Place the transmission in neutral.
3. Start the engine and allow it to idle for five minutes, or until operating temperature is reached.
4. Turn the idle adjusting wheel (1) until idle speed reaches 1700-1800 RPM.

**NOTE:** If idle speed is unsatisfactory after performing this procedure, see your Polaris dealer for information about jetting changes.



### Carburetor

#### Carburetor Draining

Drain the carburetor float bowl at the intervals outlined in the Periodic Maintenance Chart beginning on page 97. Always drain the bowl after exposure to wet conditions. Perform this procedure when the engine is cool.

1. Turn the fuel valve off.
2. Place a suitable container under the carburetor to collect drained fluid.
3. Remove the hex plug (1). Allow fluids to drain.
4. Reinstall the hex plug securely.

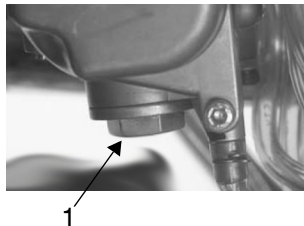



# Maintenance

## Carburetor Jetting

Carburetor re-jetting can be performed to compensate for altitude and/or temperature changes. If the vehicle is to be operated at various altitudes and temperatures, certain adjustments can be made to improve its operation and driveability. Above 6000 feet (1800 m) the engine air/fuel mixture becomes overly rich. An engine loses approximately 3% of its power for each 1000-foot (305 m) increase in elevation. Although this power cannot be regained, changes to the carburetor and drive system can be made to allow more efficient operation.

**NOTE:** Contact your dealer for altitude adjustments. Your dealer has the training and special tools required to perform these modifications.

### Lights

When servicing a halogen lamp, don't touch the lamp with bare fingers. Oil from your skin leaves a residue, causing a hot spot that will shorten the life of the lamp.

#### **WARNING**

Poor lighting while driving can result in severe injury or death. Headlight and taillight lenses become dirty during normal operation. Wash the headlights frequently to maintain lighting quality.

Hot components can cause serious burns to skin. Do not service the headlamps until they've cooled sufficiently.

# Maintenance

## Lights

### Headlight Adjustment

1. Position the vehicle on a level surface with the headlight approximately 25 ft. (7.6 m) from a flat wall.
2. Measure the distance from the floor to the center of the headlight and make a mark on the wall at the same height.
3. Start the engine and turn the headlight switch to high beam.
4. Observe the headlight aim on the wall. The most intense part of the headlight beam should be aimed 2" (5 cm) below the mark placed on the wall.

**NOTE:** Include rider weight on the seat when measuring.

5. Loosen the pivot screw and adjust the beam to the desired position.
6. Tighten the screw and torque to 27 in. lbs. (3 Nm).

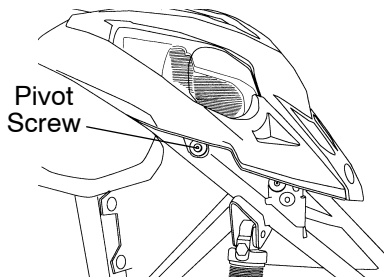

## Lights

### Headlight Lamp Replacement

1. Remove the wire harness connector from the back of the headlight.
2. On the left headlamp, grasp the bulb housing and turn it *counterclockwise* to remove the bulb. On the right headlamp, turn the bulb housing *clockwise* to remove the bulb.
3. Apply dielectric grease to the socket and install the new bulb. Rotate firmly.

**NOTE:** The bulb must be positioned so the harness installs into the lamp at outer side.

4. Reinstall the connector to the back of the headlight.

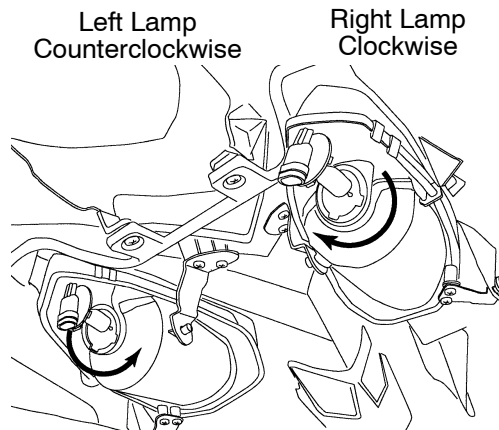

# Maintenance

## Lights

### Headlight Assembly Replacement

1. Remove the wire harness connector from the headlights.
2. Remove the front cab (see page 133).
3. Remove the small adjuster bracket. Install it on the new lamp.
4. Remove the large pivot bracket and remove the headlamp.
5. Install the new headlamp by inserting the outboard pivot pin in the hole of the mounting tab on the cab.

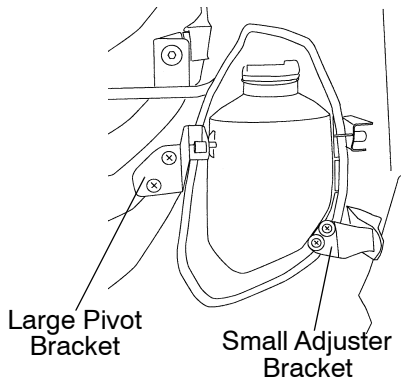

## Lights

### Headlight Assembly Replacement

6. Install the adjuster bracket onto the inboard pivot pin of the headlamp. Adjust for approximately 1/16" clearance between the bracket and the edge of the headlight. Tighten the mounting screws. **IMPORTANT:** Be sure the bracket is 90 degrees to the pivot pin so the lamp can move freely.
7. Install the adjusting screw, leaving it loose so the headlight can be adjusted.
8. Reinstall the front cab. Connect the wire harness to the headlamp.
9. Adjust the lamps as needed (see page 128), then tighten the adjuster screw.

# Maintenance

## Lights

### Brake Light Adjustment

If your model is equipped with a mechanical brake light switch, perform the following procedure to check the rear brake light for proper operation before each use of the vehicle.

1. Turn the ignition key on.
2. Lightly apply and release the foot brake several times. A properly operating rear brake light will immediately flash on and off with each movement of the brake pedal.
3. If the light does not operate properly, grasp the switch body with a pliers or similar tool and hold it lightly, but securely. Using a wrench, rotate the adjustment nut clockwise to increase tension on the spring.

**NOTE:** Rotate the adjusting nut counter-clockwise to decrease tension on the spring if the brake light comes on when there is no pressure on the brake pedal.

4. Recheck and readjust as needed until the brake light operates properly.

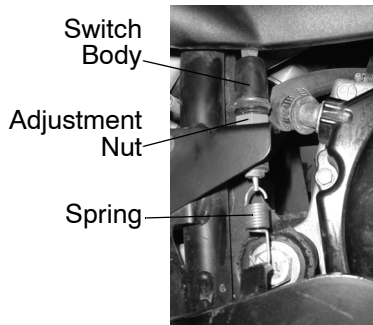

### Front Cab Removal

1. Remove the left and right cab mount screws (1).
2. Remove the wire harness connector from the cab. The connector is located under the left fender.
3. Remove the fuel tank cover screws (2).
4. Remove the four side panel screws (3).
5. Gently pull the cab upward to disengage it from the stand-off. Place the cab upside down on a soft protective surface to prevent scratching.

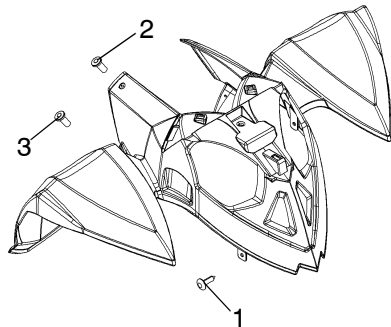



## Maintenance

### Side Panel Removal

1. Unlatch and remove the seat. Remove the front cab.
2. Remove the two screws securing the side panel.
3. Remove the side panel.

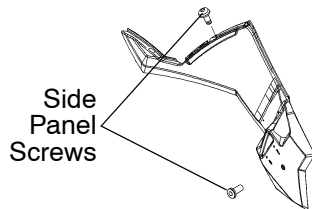

### Rear Cab Removal

1. Unlatch and remove the seat.
2. Remove the two lower bolts (1) on the rear fenders of the cab.
3. Remove the two bolts (2), washers and grommets (3) on the top of the cab.
4. Remove the cab.

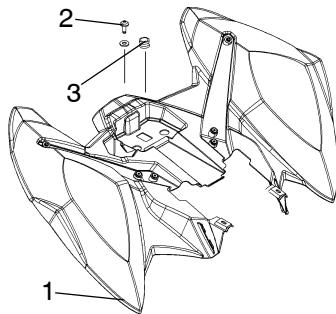

### Spark Plugs

Refer to the specifications section beginning on page 182 for recommended spark plug type and gap.

#### **CAUTION**

Using non-recommended spark plugs may result in serious engine damage and may void your emission-related warranty. Always use Polaris-recommended spark plugs.

Spark plug condition is indicative of engine operation. The spark plug firing end condition should be read after the engine has been warmed up and the vehicle has been driven at higher speeds. Immediately check the spark plug for correct color.

#### **WARNING**

A hot exhaust system and engine can cause serious burns. Wear protective gloves when removing a spark plug for inspection. Allow components to cool before continuing.

# Maintenance

## Spark Plugs

### Normal Plug

The normal insulator tip is gray, tan or light brown. There will be few combustion deposits. The electrodes are not burned or eroded. This indicates the proper type and heat range for the engine and the service.

**NOTE:** The tip should not be white. A white insulator tip indicates overheating, caused by use of an improper spark plug or incorrect carburetor/throttle body adjustments.

### Wet Fouled Plug

The wet fouled insulator tip is black. A damp oil film covers the firing end. There may be a carbon layer over the entire nose. Generally, the electrodes are not worn. General causes of fouling are excessive oil, use of non-recommended oil, improper use of the choke, or incorrect carburetion adjustments.

## Spark Plugs

### Spark Plug Removal

1. Access the spark plug at the right side of the engine.
2. Using the spark plug socket and a wrench, rotate counterclockwise to remove the spark plug.
3. After reinstalling the spark plug, torque to 14 ft. lbs. (19 Nm).

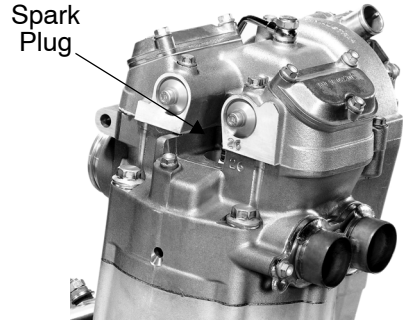

## Maintenance

### Spark Arrestor Clean-Out

To remove accumulated carbon, clean the spark arrestor at the intervals recommended in the Periodic Maintenance Chart beginning on page 97.

#### **WARNING**

Failure to heed these warnings could result in serious injury or death.

Do not perform clean-out immediately after the engine has been run, as the exhaust system becomes very hot. Serious burns could result from contact with the exhaust components.

Wear eye protection and gloves.

Never run the engine in an enclosed area. Exhaust contains poisonous carbon monoxide gas.

### Spark Arrestor Clean-Out

Periodically clean the spark arrestor to remove accumulated carbon.

1. Remove the retaining screw and remove the arrestor from the end of the muffler.
2. Use a non-synthetic brush to clean the arrestor screen. A synthetic brush may melt if components are warm.

**NOTE:** If necessary, blow debris from the screen with compressed air.

3. Inspect the screen for wear and damage. Replace a worn or damaged screen.
4. Reinstall the arrestor. Torque screws to 5-7 ft. lbs. (7-9 Nm).

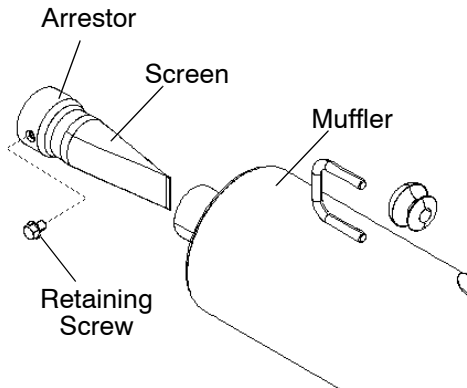

## Maintenance

### Vehicle Immersion

If your ATV has been submerged or overturned in water deeper than the footpeg level, it's critical to dry it promptly and properly before starting the engine.

#### CAUTION

Do not start the engine after an ATV has been in water that exceeds the recommended depth. Serious engine damage WILL occur. Tow or trailer the ATV to your dealer for service. In an emergency, perform the temporary drying out procedure outlined below, which will allow *short-term operation only*, to drive the ATV to a trailer or towing vehicle.

Do not perform the following procedures if you don't feel completely capable, or if you suspect that water has entered the fuel tank (likely if the water was deep or if the ATV overturned). Tow or trailer the ATV to your dealer for immediate service.

### Vehicle Immersion

1. Turn the fuel valve off.
2. Drain water from the air box and clean the air filter. See page 122.
3. Drain the carburetor bowl. See page 125.
4. Remove the spark plug. See page 137.

<p><b> WARNING</b></p>
---

<p>Fluids will be ejected through the spark plug hole and may cause serious injury to face or other body parts. Stand clear of the spark plug while performing the following steps.</p>
---

5. Intermittently and briefly touch the starter button in half-second intervals to SLOWLY rotate the engine three or four times. Water will eject from the spark plug hole.  
(continued on following page)



## Maintenance

### Vehicle Immersion

6. Press and hold the starter button for 10 second intervals for about one minute or until water vapor is no longer ejecting from the spark plug hole.
7. Check the oil level. If the level is higher than the pre-ride inspection level, water has entered the crankcase. *Do not start the engine.* Transport the vehicle to your dealer for inspection and service. If the oil level is unchanged from the pre-ride inspection level, replace the spark plug, start the engine and move the ATV promptly to a trailer or towing vehicle.

### CAUTION

If water isn't removed promptly from a submerged ATV, rust will form in precision components, gears, bearings, the cylinder and other areas and result in serious engine damage. Always see your dealer promptly after an ATV has been submerged.

### Battery

The sealed battery is already filled with electrolyte and has been sealed and fully charged at the factory. *Never* pry the sealing strip off or add any other fluid to this battery.

Keep the battery terminals and connections free of corrosion. If cleaning is necessary, remove the corrosion with a stiff wire brush. Wash with a solution of one tablespoon baking soda and one cup water. Rinse well with tap water and dry off with clean shop towels. Coat the terminals with dielectric grease or petroleum jelly.

#### **WARNING**

Improperly connecting or disconnecting battery cables can result in an explosion and cause serious injury or death. When removing the battery, always disconnect the negative (black) cable first. When reinstalling the battery, always connect the negative (black) cable last.

## **Maintenance**

### **Battery Storage**

Whenever the vehicle is not used for a period of three months or more, remove the battery from the vehicle, ensure that it's fully charged, and store it out of the sun in a cool, dry place. Check battery voltage each month during storage and recharge as needed to maintain a full charge.

### **Battery Removal**

1. Remove the rear cab (see page 133).
2. Disconnect the hold-down strap securing the battery in position.
3. Disconnect the black (negative) battery cable first.
4. Disconnect the red (positive) battery cable last.
5. Lift the battery out of the ATV.

### Battery Installation

**NOTE:** Always install a fully charged battery. Using a new battery that has not been fully charged can damage the battery and result in a shorter life. It can also hinder vehicle performance. If recharging is necessary, use a .5 amp battery charger.

1. Place the battery in the battery holder.
2. Connect and tighten the red (positive) cable first.
3. Connect and tighten the black (negative) cable last.
4. Attach the hold-down strap.
5. Reinstall the rear cab.
6. Verify that cables are properly routed.

# Maintenance

## Battery Charging (Sealed Battery)

On a sealed battery, the sealing strip cannot be removed. Use a voltmeter or multimeter to measure DC voltage. A fully charged battery will register 12.8 V or higher. If the voltage is less than 12.8 volts, recharge the battery.

### **⚠ WARNING**

Improperly connecting or disconnecting battery cables can result in an explosion and cause serious injury or death. When removing battery cables, always disconnect the negative (black) cable first. When installing battery cables, always connect the negative (black) cable last.

The battery may be recharged without removing it from the vehicle. Attach cables in the following order:

1. Attach the positive (+) cable clamp to the solenoid lead (directly wired to the battery).
2. Attach the negative (-) cable clamp to the negative (-) battery terminal.

2. Negative (-) Terminal

1. Solenoid Lead

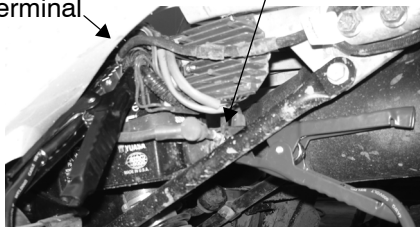

### Battery Charging (Sealed Battery)

**NOTE:** The Polaris Battery Tender battery charger can be left connected during the storage period and will automatically charge the battery if the voltage drops below a pre-determined point.

**NOTE:** If the battery fails to recharge during vehicle operation, check voltage regulator connections. See your Polaris dealer for inspection of the voltage regulator and generator.

When using an automatic charger such as the Polaris Battery Tender, refer to the manufacturer's instructions for recharging. When using a constant current charger, use the guidelines on the following page for recharging.

#### **WARNING**

An overheated battery could explode, causing severe injury or death. Always watch charging times carefully. Stop charging if the battery becomes very warm to the touch. Allow it to cool before resuming charging.

# Maintenance

## Battery Charging (Sealed Battery)

**NOTE:** Always verify battery condition before and 1-2 hours after the end of charging.

<b>State of Charge</b>	<b>Voltage</b>	<b>Action</b>	<b>Charge Time</b> (Using constant current charger @ standard amps specified on top of battery)
100%	12.8-13.0 volts	None, check at 3 months from date of manufacture	None required
75%-100%	12.5-12.8 volts	May need slight charge, if no charge given, check in 3 months	3-6 hours
50%-75%	12.0-12.5 volts	Needs charge	5-11 hours
25%-50%	11.5-12.0 volts	Needs charge	At least 13 hours, verify state of charge
0%-25%	11.5 volts or less	Needs charge with desulfating charger	At least 20 hours

## Tires

### **⚠ WARNING**

Operating your ATV with worn tires, improperly inflated tires, non-standard tires or improperly installed tires will affect vehicle handling and could cause an accident resulting in serious injury or death.

Maintain proper tire pressure as described on the decal on your ATV and in the owner's manual.

Always use original equipment size and type when replacing tires.

Make sure the wheels are installed properly.

Always replace tires when the tread depth measures 1/8" (3 mm) or less.

### **Tire Tread Depth**

Always replace tires when tread depth is worn to 1/8" (3 mm) or less.

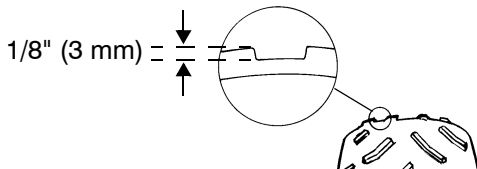



## Maintenance

### Wheel Nut Torque Specifications

Check the wheel nut torques occasionally and when they've been loosened for maintenance.

Bolt Location & Size	Torque Specification
Front 3/8"	30-35 ft. lbs. (40-47 Nm)
Rear 3/8"	30-35 ft. lbs. (40-47 Nm)

### Wheel Hub Tightening

Front wheel bearing tightness and spindle nut retention are critical component operations. All service must be performed by your authorized Polaris dealer.

### Wheel Removal

1. Stop the engine. Place the transmission in gear. Lock the parking brake.
2. Loosen the wheel bolts slightly.
3. Elevate the side of the vehicle by placing a suitable stand under the frame.
4. Remove the wheel nuts and remove the wheel.

## Wheel Installation

### **⚠ WARNING**

Improperly installed wheels can adversely affect tire wear and vehicle handling, which can result in serious injury or death. Never install the rim with the valve stem to the inside of the vehicle. Always ensure that all nuts are torqued to specification.

1. Place the transmission in gear. Lock the parking brake.
2. Place the wheel on the wheel hub with the valve stem toward the outside and rotation arrow on the tire pointing toward forward rotation.
3. Install the wheel bolts and finger tighten them.
4. Lower the vehicle to the ground.
5. Securely tighten the bolts to specification. See page 150.

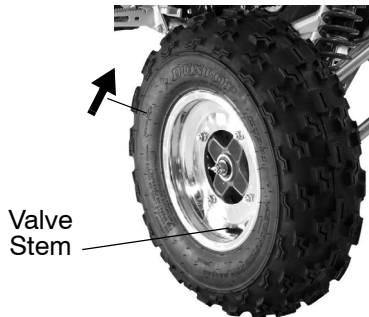

# Maintenance

## Clutch System Bleeding

Always bleed the clutch system at the intervals outlined in the Periodic Maintenance Chart beginning on page 97. Always bleed the clutch system any time the clutch lever feels unresponsive.

Always use the recommended fluid when bleeding the clutch system. See page 55.

1. Position the vehicle on a level surface. Turn the handlebar until the master cylinder is in a horizontal position.
2. Remove the two cover screws, the cover and the rubber boot.
3. Fill a bleeder syringe (1) with the recommended hydraulic clutch oil.



### Clutch System Bleeding

4. Remove the bleeder screw (2) from the slave cylinder.
5. Press fluid into the system until the fluid runs out of the hole (3) in the master cylinder without producing bubbles.

**NOTE:** Extract fluid from the master cylinder during the process to prevent overflowing.

6. When finished, remove the bleeder syringe.
7. Reinstall the bleeder screw.
8. Add or remove fluid as needed to maintain the level 4mm below the top edge of the master cylinder reservoir.
9. Reinstall the cover, boot and screws securely.

## Maintenance

### Throttle Lever Freeplay

Periodically check throttle lever freeplay. Maintain freeplay between 1/16" and 1/8" (1.5 - 3 mm).

If adjustments are needed, use the procedure on page 155.

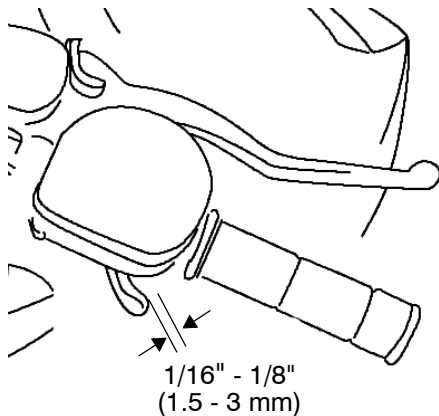

## Throttle Cable Freeplay Adjustment

### **⚠ WARNING**

Improper adjustment of throttle cable freeplay can result in loss of control, which could result in serious injury or death. Polaris recommends that this procedure be performed by a Polaris dealer to ensure that it's done correctly. Mechanically knowledgeable persons who perform this procedure must follow the adjustment procedures exactly.

1. Locate the throttle cable at the handlebar.
2. Slide the boots off the inline cable adjuster sleeve and loosen the locking nut.
3. Turn the adjuster until  $1/16"$  to  $1/8"$  (1.5-3 mm) freeplay is achieved at the thumb lever.

**NOTE:** While adjusting freeplay, be sure to flip the throttle lever back and forth.

4. Tighten the locknut and slide the boots over the cable adjuster until they touch at the midpoint of the adjuster.

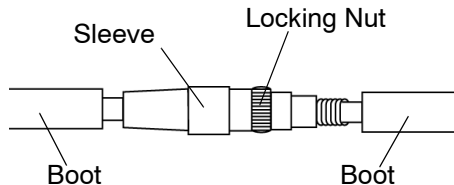

## Maintenance

### Brakes

#### **WARNING**

An over-full master cylinder may cause brake drag or brake lock-up, which could result in serious injury or death. Maintain brake fluid at the recommended level. Do not overfill.

Both brakes are self-adjusting, but the following checks are recommended to keep the brake systems in good operating condition. Check more often if brakes are used heavily under normal operation.

## Maintenance

### Brakes

1. Always maintain brake fluid at the recommended level. See pages 60-61.
2. Check the brake system for fluid leaks.
3. Check the brakes for excessive travel or spongy feel.
4. Check the friction pads for wear, damage and looseness.
5. Check the security and surface condition of the disc.
6. Inspect the rear brake disc spline and pad wear surface for excessive wear.

**NOTE:** Pads should be changed when worn to 3/64" (1 mm).

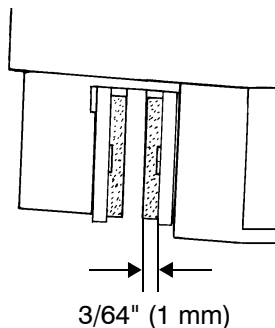



## Maintenance

### Toe Alignment

#### **WARNING**

Severe injury or death can result from improper toe alignment and adjustment. Do not attempt to adjust tie rod alignment. All tie rod adjustments should be performed by an authorized Polaris dealer.

Use the following procedure to check the toe alignment of the vehicle. The vehicle is designed for a neutral toe setting.

1. Position the vehicle on a level surface.
2. Place the handlebars in a straight-ahead position. Use tie straps to secure the handlebars to the rear grab bar so they can't move.

### Toe Alignment

3. Tie a length of string between two stands as shown in the illustration. Position the stands so that the string is flush with the side of the rear tire.

**NOTE:** If available, you may use a long straight-edge instead of string.

4. Measure the distance from the string to the rim at the front (1) and rear (2) of the front rim. The rear measurement should be between 0" and 1/16" (0-1.5 mm) more than the front measurement.
5. Repeat the measurement procedure on the other side of the vehicle.

**NOTE:** If you discover improper alignment, see your Polaris dealer for service.

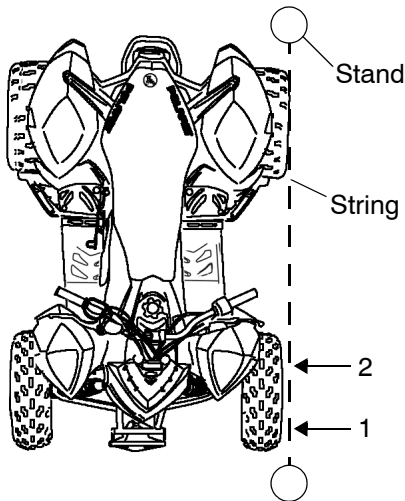

# Maintenance

## Chain Tension Inspection

### CAUTION

Never adjust or operate the vehicle with the rear drive chain too loose or too tight. Severe damage to the transmission and drive components can result. Chain tension must be inspected with the swing arm in the position shown in the illustration so that the axle, swing arm pivot and drive sprocket are aligned horizontally (2).

Check the amount of chain slack by moving the vehicle slightly forward to remove slack at the top side of the chain.

**NOTE:** The chain has a press-on master link. A chain tool must be used if it's necessary to remove the chain for service.

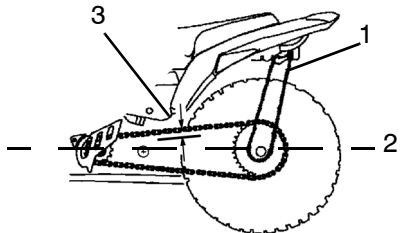

### Chain Tension Inspection

1. Collapse the suspension with an adjustable (buckle type) trailer tie down strap (1). Fasten the strap around the axle and rear bumper tube.
2. Tighten the strap until a straight line (2) can be drawn from the axle to the transmission output shaft, intersecting the swing arm pivot. This establishes the tightest chain position.
3. At the center point of the chain (3) deflection should be 1/4" - 3/8" (6-9 mm). Use the procedure on the following page if the chain needs adjustment.

# Maintenance

## Chain Tension Adjustment

1. Loosen the two eccentric locking bolts.

**NOTE:** Refer to the illustration on the following page.

2. Insert a pin punch into the eccentric axle housing.

3. Roll the vehicle slightly to adjust chain slack to the proper dimension.

4. Tighten the eccentric locking bolts to 35 ft. lbs. (47.5 Nm).

## Chain Tension Adjustment

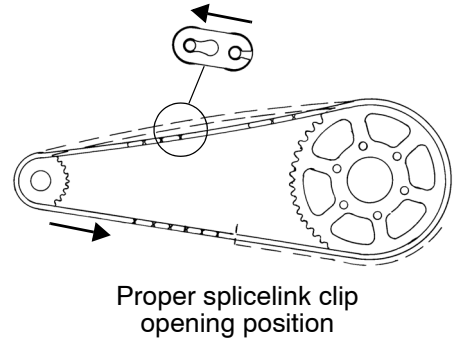
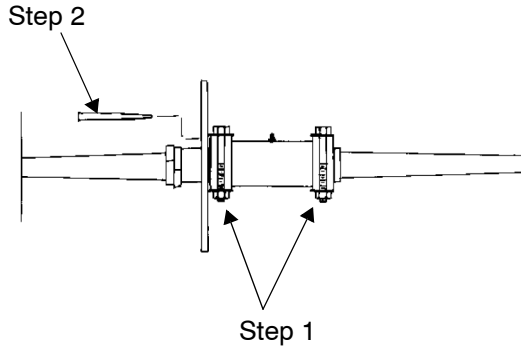

# Maintenance

## Handlebar Adjustment

### **⚠ WARNING**

Improper adjustment of the handlebars or incorrect torquing of the adjuster block tightening bolts can cause limited steering or loosening of the handlebars, resulting in loss of control and possible serious personal injury or death. Follow the adjustment procedures exactly, or see your Polaris dealer for service.

The handlebars can be adjusted for rider preference.

1. Loosen the four handlebar bolts.
2. Adjust the handlebar to the desired height. Be sure the handlebars do not contact the gas tank or any other part of the machine when turned fully to the left or right.
3. Torque the two front bolts to 10-12 ft. lbs. (14-16 Nm), then torque the two rear bolts.

**NOTE:** A gap of up to 1/8" (3 mm) will remain at the rear bolts.

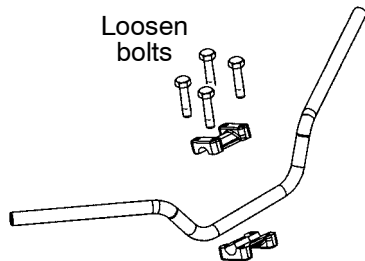

### Steering Inspection

Check the steering assembly periodically for loose nuts and bolts. If loose nuts and bolts are found, or if you notice any freeplay in the steering post, see your Polaris dealer for service before operating the vehicle.

### Camber and Caster

The camber and caster are non-adjustable.



# Maintenance

## Suspension Settings

Use a flat-blade screwdriver to make damping adjustments.

**NOTE:** When the adjuster screw is turned clockwise until it stops, the damping is in the fully closed position.

### Rear Shock (Standard and Limited Edition)

Setting	Compression Damping	Rebound Damping
Softest	20 clicks from closed	24 clicks from closed
Factory	10 clicks from closed	16 clicks from closed
Firmer	2 clicks from closed	2 clicks from closed

### Front Shock (Limited Edition)

Setting	Compression
Softest	20 clicks from closed
Factory	10 clicks from closed
Firmer	2 clicks from closed

### Front Suspension

#### Compression Damping (Limited Edition)

To adjust the front suspension compression damping, use the adjustment procedures outlined for the rear suspension compression damping on page 171.

#### Spring Preload

The front suspension preload may be adjusted to suit different riding conditions and operator weight. See page 168.

#### **WARNING**

Uneven adjustment may cause poor handling of the ATV, which could result in an accident and serious injury or death. Always adjust both the left and right spring preloads equally or have your Polaris dealer perform the adjustments.

# Maintenance

## Front Suspension

### Spring Preload

1. Raise and safely support the front of the vehicle off the ground to allow the suspension to fully extend.
2. Turn the adjuster to the left (1) to increase preload for a stiffer ride. Turn the adjuster to the right (2) to decrease preload for a softer ride.

**NOTE:** See Suspension Settings on page 166.

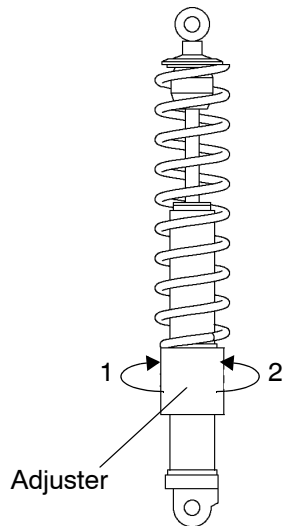

## Maintenance

### Rear Suspension

The rear suspension spring preload, shock rebound damping and shock compression damping may be adjusted to suit different riding conditions and operator weight.

#### Spring Preload

1. Raise and safely support the rear of the vehicle off the ground to allow the suspension to fully extend.
2. Loosen the jam nut and back it away from the adjusting ring.
3. Turn the adjusting ring to the left (1) to increase preload. Turn the ring to the right (2) to decrease preload.

**NOTE:** See Suspension Settings on page 166.

4. Tighten the jam nut firmly against the adjuster ring.

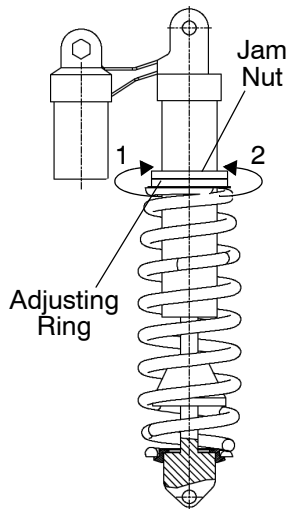

# Maintenance

## Rear Suspension

### Rebound Damping

Use a flat-blade screwdriver to make damping adjustments.

1. Locate the rebound damping clicker drum between the lower spring seat and the lower shock mount.
2. Turn the clicker counter-clockwise (1) to decrease the rebound damping. Turn the clicker clockwise (2) to increase rebound damping.

**NOTE:** The rebound damping is factory set at 16 clicks from fully closed. See Suspension Settings on page 166.

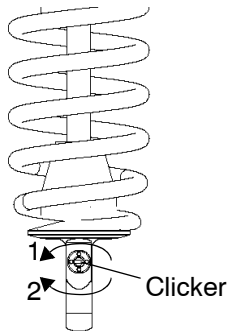

### Rear Suspension Compression Damping

Use a flat-blade screwdriver to make damping adjustments.

The compression damping clicker is located on top of the shock reservoir, under the right rear fender.

Turn the clicker clockwise (1) to increase compression damping. Turn the clicker counter-clockwise (2) to decrease compression damping.

**NOTE:** The factory setting is at 10 clicks from fully closed. See Suspension Settings on page 166.



## Maintenance

### Cleaning

Keeping your vehicle clean will not only improve its appearance but it can also extend the life of various components.

#### **CAUTION**

High water pressure may damage components. Polaris recommends washing the vehicle by hand or with a garden hose, using mild soap.

Certain products, including insect repellents and chemicals, will damage plastic surfaces. Do not allow these types of products to contact the vehicle.

### Cleaning

#### Washing the Vehicle

The best and safest way to clean your Polaris vehicle is with a garden hose and a pail of mild soap and water.

1. Use a professional-type washing cloth, cleaning the upper body first and the lower parts last.
2. Rinse with clean water frequently.
3. Dry surfaces with a chamois to prevent water spots.



# Maintenance

## Cleaning

### Washing the Vehicle

#### Washing Tips

- Avoid the use of harsh cleaners, which can scratch the finish.
- Do not use a power washer to clean the vehicle.
- Do not use medium to heavy duty compounds on the finish.
- Always use clean cloths and pads for cleaning and polishing. Old or reused cloths and pads may contain dirt particles that will scratch the finish.

## Cleaning

### Washing the Vehicle

If a high pressure water system is used for cleaning (not recommended), exercise extreme caution. The water may damage components and could remove paint and decals. Avoid directing the water stream at the following items:

- Wheel bearings
- Electrical components and wiring
- Transmission seals
- Brakes
- Cab and body panels
- Labels and decals

**NOTE:** If warning and safety labels are damaged, contact your Polaris dealer for free replacement.

Grease all zerk fittings immediately after washing. Allow the engine to run for a while to evaporate any water that may have entered the engine or exhaust system.

## **Maintenance**

### **Polishing**

Polaris recommends the use of common household aerosol furniture polish for polishing the finish on your Polaris vehicle. Follow the instructions on the container.

#### **Polishing Tips**

- Avoid the use of automotive products, some of which can scratch the finish of your vehicle.
- Always use clean cloths and pads for cleaning and polishing. Old or reused cloths and pads may contain dirt particles that will scratch the finish.

## Storage

### CAUTION

Starting the engine during the storage period will disturb the protective film created by fogging and damage could occur. Never start the engine during the storage period.

## Exterior

Make necessary repairs and clean the vehicle as recommended. See page 172.

## Battery Storage

Refer to pages 143-148 for battery storage and battery charging procedures.

## **Maintenance**

### **Storage**

#### **Engine Oil**

Change the oil and both filters. Clean the oil screens. See page 110.

#### **Air Filter / Air Box**

Inspect and clean (or replace) the air filter. Clean the air box. Drain the sediment tube.

#### **Fluid Levels**

Inspect fluid levels. Change fluids as recommended in the Periodic Maintenance Chart beginning on page 97.

- Transmission Oil
- Engine Oil
- Coolant (test strength/fill)
- Brake Fluid
- Clutch Fluid

## Storage

### Stabilize the Fuel

1. Fill the fuel tank with fuel.
2. Add Polaris Carbon Clean Fuel Treatment or Polaris Fuel Stabilizer. Follow the instructions on the container for the recommended amount.

**NOTE:** Carbon Clean removes water from fuel systems, stabilizes fuel and removes carbon deposits from pistons, rings, valves and exhaust systems. It also prevents bacterial growth and promotes better starting after the storage period.

3. Start the engine and allow it to run for 15-20 minutes so the stabilizer can disperse through the fuel in the tank and carburetor.
4. Stop the engine. Turn the fuel valve off.
5. Start the engine. Allow the engine to operate until it stops.
6. Drain the carburetor bowl. See page 125.
7. Remove the spark plug. Pour approximately 5 cc of engine oil into the cylinder through the opening. Using the start button, rotate the engine several times to distribute the oil onto the cylinder walls. Reinstall the spark plug. Torque to specification.

# Maintenance

## Storage

### Lubricate

Inspect all cables and lubricate all areas of the vehicle as recommended in the Periodic Maintenance Chart beginning on page 97.

### Storage Area/Covers

1. Make sure tire pressure is at specification.
2. Be sure the storage area is well ventilated.
3. Using suitable supports under the frame, raise the vehicle slightly so that the tires are not touching the ground.
4. Cover the vehicle with an appropriate cover.

**NOTE:** Do not use plastic or coated materials. They do not allow enough ventilation to prevent condensation, and may promote corrosion and oxidation.

## Maintenance

### Transporting the ATV

Follow these procedures when transporting the vehicle.

1. Stop the engine.
2. Place the transmission in first gear.
3. Lock the parking brake.
4. Remove the key to prevent loss during transporting.
5. Secure the fuel cap, oil cap and seat.
6. Turn the fuel valve off.
7. Always tie the *frame* of the ATV to the transporting unit securely with suitable straps or rope.

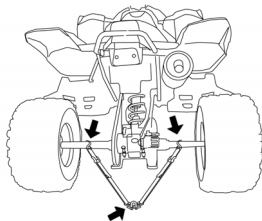
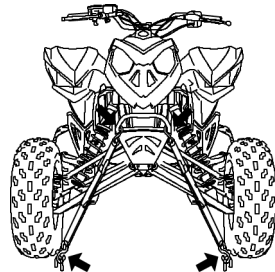



# Specifications

<b>Outlaw 450 S</b>				
Max. Weight Capacity	215 lbs./97.5 kg		Pilot Jet	See your owner's manual supplement or your Polaris dealer
Dry Weight	365 lbs./166 kg		Main Jet	
Fuel Capacity	3.9 gal./14.8 l		Needle Jet	
Overall Length	71.5 in./182 cm		Jet Needle	
Overall Width	47 in./119 cm		Alternator Output	200 w @ 3000 RPM
Overall Height	45 in./114 cm		Compression Ratio	11:1
Wheelbase	50.5 in./128 cm		Starting System	Electric
Ground Clearance	5 in./13 cm		Carburetor	Keihin FCR-MX 39mm
Min. Turning Radius	67 in./170 cm		Ignition System	CDI
Engine Oil Capacity	1.9 qts./1.8 l		Ignition Timing	25° +/- 3° @ 3500 RPM in neutral
Coolant Capacity	2.25 qts./2.1 l		Spark Plug Type	NGK DCPR8E
Engine	ES45KLE		Spark Plug Gap	0.6 mm / .024 in.
Displacement	448 cc		Lubrication System	Dry Sump/Internal Reservoir
Bore x Stroke	89 x 72 mm			

# Specifications

Outlaw 450 S				
Driving System Type	Rear Two-Wheel Drive		Tire Size - Front	20 x 6R10
Shift Type	5-Speed Manual Shift		Tire Size - Rear	18 x 10R9
Primary Ratio	2.516		Tire Pressure - All	4 psi/27.6 KPa
Gear Ratio - 1st	2.500		Front Brake	Hydraulic Disc, Dual Bore
Gear Ratio - 2nd	1.941		Rear Brake	Hydraulic Disc
Gear Ratio - 3rd	1.579		Parking Brake	Hydraulic lock, front wheel
Gear Ratio - 4th	1.333		Headlights	2 Dual Beam (35w/35w)
Gear Ratio - 5th	1.130		Taillights	LED
Gear Ratio - Reverse	2.429		Brakelight	26.9w

## Outlaw 450 S Jetting Chart

Please see your owner's manual supplement or your Polaris dealer for jetting information.

# Specifications

<b>Outlaw 525 S</b>				
Max. Weight Capacity	215 lbs./97.5 kg		Pilot Jet	#45
Dry Weight	375 lbs./170 kg		Main Jet	#138
Fuel Capacity	3.9 gal./14.8 l		Clip Position	4
Overall Length	71.5 in./182 cm		Jet Needle	OBDVS
Overall Width	47.5 in./121 cm		Alternator Output	200 w @ 3000 RPM
Overall Height	45 in./114 cm		Compression Ratio	11:1
Wheelbase	50.5 in./128 cm		Starting System	Electric
Ground Clearance	5 in./13 cm		Carburetor	Keihin FCR-MX 39mm
Min. Turning Radius	67 in./170 cm		Ignition System	CDI
Engine Oil Capacity	1.9 qts./1.8 l		Ignition Timing	25° +/- 3° @ 3500 RPM in neutral
Coolant Capacity	2.25 qts./2.1 l		Spark Plug Type	NGK DCPR8E
Engine	ES51KLE		Spark Plug Gap	0.6 mm / .024 in.
Displacement	510 cc		Lubrication System	Dry Sump/Internal Reservoir
Bore x Stroke	95 x 72 mm			

# Specifications

<b>Outlaw 525 S</b>				
Driving System Type	Rear Two-Wheel Drive		Tire Size - Front	21 x 7R10
Shift Type	5-Speed Manual Shift		Tire Size - Rear	20 x 11R9
Primary Ratio	2.516		Tire Pressure - All	4 psi/27.6 KPa
Gear Ratio - 1st	2.500		Front Brake	Hydraulic Disc, Dual Bore
Gear Ratio - 2nd	1.941		Rear Brake	Hydraulic Disc
Gear Ratio - 3rd	1.579		Parking Brake	Hydraulic lock, front wheel
Gear Ratio - 4th	1.333		Headlights	2 Dual Beam (35w/35w)
Gear Ratio - 5th	1.130		Taillights	LED
Gear Ratio - Reverse	2.429		Brakelight	26.9w

## Outlaw 525 S Jetting Chart

ALTITUDE Meters (Feet)	AMBIENT TEMPERATURE	
	Below 40° F (Below 5° C)	+40°F and above (+5°C and above)
0-1800 (0-6000)	Main Jet: 148 Needle Clip Position: #4	Main Jet: 138 Needle Clip Position: #4
1800-3700 (6000-12000)	Main Jet: 138 Needle Clip Position: #3	Main Jet: 128 Needle Clip Position: #3

## Polaris Products

Part Number	Description
<b>Engine Lubricant</b>	
2876244	PS-4 PLUS Performance Synthetic 2W-50 4-Cycle Oil (qt.)
2876245	PS-4 PLUS Performance Synthetic 2W-50 4-Cycle Oil (gal.)
<b>Grease / Specialized Lubricants</b>	
2871312	Grease Gun Kit, Premium All Season (3 oz.)
2871322	Premium All Season Grease (3 oz. cartridge)
2871423	Premium All Season Grease (14 oz. cartridge)
2871460	Starter Drive Grease (2 oz.)
2871329	Dielectric Grease (Nyogel™)
2872073	Chain Lube, Aerosol (6.25 oz.)
2872348	Chain Lube, Aerosol (16 oz.)
1350046	Rear Shaft Grease (30 g)

## Polaris Products

<b>Part Number</b>	<b>Description</b>
<b>Coolant</b>	
2871323	60/40 Coolant (gal.)
2871534	60/40 Coolant (qt.)
<b>Additives / Miscellaneous</b>	
2871326	Carbon Clean Plus (12 oz.)
2870652	Fuel Stabilizer (16 oz.)
2872189	DOT4 Brake Fluid (12 oz.)
2876335	Hydraulic Clutch Oil (qt.)

# Troubleshooting

See your Polaris dealer if you're unable to identify solutions using the following charts.

## Engine Turns Over, Fails to Start

Possible Cause	Solution
Out of fuel	Turn the fuel valve to reserve, refuel
Water is present in carburetor or fuel supply	Clean carburetor and/or drain fuel system and refuel
Fuel valve is turned off	Turn the fuel valve on
Engine is cold	Use choke to start a cold engine
Interrupted fuel supply	Turn the fuel valve off; remove the fuel hose at the carburetor and place in a drain pan; turn the fuel valve on. <ul style="list-style-type: none"><li>• If fuel leaks out, clean the carburetor.</li><li>• If no fuel leaks out, clean the fuel valve.</li></ul>
Clogged fuel valve or filter	Inspect and clean or replace
Old or non-recommended fuel	Replace with new fuel
Fouled or defective spark plug(s)	Inspect and clean or replace plug(s)
Incorrect spark plug gap	Adjust gap to specification

# Troubleshooting

## Engine Turns Over, Fails to Start

Possible Cause	Solution
No spark to spark plug	Inspect, clean and/or replace spark plugs See your Polaris dealer
Overuse of choke/flooded engine	Engage starter 2 times for 5 seconds each, then restart. If engine fails to start, inspect, clean and/or replace spark plugs.
Low battery voltage	Recharge battery to 12.8 VDC
Ignition system or other mechanical failure	See your Polaris dealer
Throttle ETC switch not opening	Adjust throttle freeplay
The plug connection of the CDI-unit, pulse generator or ignition coil has oxidized	Clean the plug connection and treat with contact spray



## Troubleshooting

### Engine Doesn't Turn Over

Possible Cause	Solution
Fuseable link	See Polaris dealer for replacement
Low battery voltage	Recharge battery to 12.8 VDC
Loose battery connections	Check all connections and tighten
Loose solenoid connections	Check all connections and tighten

### Engine Pings or Knocks

Possible Cause	Solution
Poor quality or low octane fuel	Replace with recommended fuel
Incorrect ignition timing	See your Polaris dealer
Incorrect spark plug gap or heat range	Set gap to specs or replace plugs

## Engine Backfires

Possible Cause	Solution
Weak, fouled or defective spark plug	Inspect, clean and/or replace spark plugs
Incorrect spark plug gap or heat range	Set gap to specs or replace plugs
Old or non-recommended fuel	Replace with new fuel
Exhaust leak	Inspect system for leaks; see your Polaris dealer
Incorrectly installed spark plug wire	See your Polaris dealer
Incorrect ignition timing	See your Polaris dealer
Mechanical failure	See your Polaris dealer

# Troubleshooting

## Engine Runs Irregularly, Stalls or Misfires

Possible Cause	Solution
Fouled or defective spark plug	Inspect, clean and/or replace spark plug
Worn or defective spark plug wire	See your Polaris dealer
Incorrect spark plug gap or heat range	Set gap to specs or replace plug
Loose ignition connections	Check all connections and tighten
Defective ignition system	See your Polaris dealer
Water present in fuel	Replace with new fuel
Low battery voltage	Recharge battery to 12.8 VDC or replace
Kinked or plugged fuel vent line	Inspect and replace
Old or non-recommended fuel	Replace with recommended fuel

# Troubleshooting

## Engine Runs Irregularly, Stalls or Misfires

Possible Cause	Solution
Clogged air filter	Inspect and clean or replace
Electronic throttle control malfunction	See your Polaris dealer
Incorrect idle adjustment	Adjust idle speed or see your Polaris dealer
Clogged idle jet	Disassemble carburetor and clean the jets
Other mechanical failure	See your Polaris dealer

# Troubleshooting

## Engine Runs Irregularly, Stalls or Misfires

<b>Possible Lean Fuel Mixture Cause</b>	<b>Solution</b>
Low or contaminated fuel	Add or change fuel, clean the fuel system
Low octane fuel	Replace with recommended fuel
Old or non-recommended fuel	Replace with recommended fuel
Clogged fuel valve screen	See your Polaris dealer
Incorrect jetting	See your Polaris dealer
<b>Possible Rich Fuel Mixture Cause</b>	<b>Solution</b>
Overuse of choke	Inspect, clean and/or replace spark plugs
Fuel is very high octane	Replace with recommended octane fuel
Incorrect jetting	See your Polaris dealer
Plugged, dirty or wet air filter	Clean pre-filter, replace main filter as needed

# Troubleshooting

## Engine Fails to Reach High RPM

Possible Cause	Solution
Worn or dirty needle valve	Clean and/or replace needle valve
Loose carburetor jets	Tighten jets
Faulty ignition timing	See your Polaris dealer

## Engine Uses Excessive Oil

Possible Cause	Solution
Bent engine ventilation hose	Install a new hose
Excessive oil in system	Check oil level, maintain at recommended level
Use of non-recommended oil (too thin)	Replace with a recommended oil

# Troubleshooting

## Engine Stops or Loses Power

Possible Cause	Solution
Out of fuel	Turn the fuel valve to reserve, refuel
Interrupted fuel supply	Clean fuel system and carburetor
Clogged, dirty or wet air filter	Inspect and clean or replace
Electronic throttle control malfunction	See your Polaris dealer
Other mechanical failure	See your Polaris dealer
Overheated engine	Clean radiator screen and core if equipped Clean engine exterior See your Polaris dealer

## Engine Stops or Loses Power

Possible Cause	Solution
Kinked or plugged fuel vent line	Inspect and replace
Water present in fuel	Replace with new fuel
Overuse of choke	Inspect, clean and/or replace spark plugs
Fouled or defective spark plug	Inspect, clean and/or replace spark plugs
Worn or defective spark plug wire	See your Polaris dealer
Incorrect spark plug gap or heat range	Set gap to specs or replace plugs
Loose ignition connections	Check all connections and tighten
Low battery voltage	Recharge battery to 12.8 VDC
Old or non-recommended fuel	Replace with recommended fuel



# Troubleshooting

## Engine Overheats

Possible Cause	Solution
Debris lodged in screen	Remove and clean the screen
Plugged radiator	Use a garden hose to flush any debris from the radiator fins. NOTE: High pressure washers can deform the radiator fins and reduce cooling efficiency.
Insufficient coolant	Check levels and fill as needed; check for leaks
Insufficient air flow due to slow operation	Operate at a faster speed to increase air flow
Cooling system has not been bled	Bleed the cooling system
Foam has formed in cooling system	Drain and replace coolant with recommended coolant
Bent cooling hose	Shorten or replace hose
Defective thermostat or thermoswitch	See your Polaris dealer
Blown fan fuse or defective fan	Replace fuse and check fan for proper operation or see your Polaris dealer

# Troubleshooting

## Engine Fails to Reach Full Power

Possible Cause	Solution
Interrupted fuel supply	Clean fuel system and carburetor
Float leaks	Replace the float
Clogged, dirty or wet air filter	Inspect and clean or replace
Faulty exhaust system	Check system for damage; see your Polaris dealer
Valve gap is too small	Adjust valve gap
Faulty ignition timing	See your Polaris dealer

# Warranty

## LIMITED WARRANTY

Polaris Sales Inc., 2100 Highway 55, Medina, MN 55340, gives a SIX MONTH LIMITED WARRANTY on all components of the Polaris All Terrain Vehicle (ATV) against defects in material or workmanship. Polaris also gives a one year limited warranty on the final drive chain for failure due to defects. This warranty covers the parts and labor charges for repair or replacement of defective parts which are covered by this warranty. This warranty begins on the date of purchase. This warranty is transferable to another consumer during the warranty period through a Polaris dealer.

## REGISTRATION

At the time of sale, the Warranty Registration Form must be completed by your dealer and submitted to Polaris within ten days. Upon receipt of this registration, Polaris will record the registration for warranty. No verification of registration will be sent to the purchaser as the copy of the Warranty Registration Form will be the warranty entitlement. If you have not signed the original registration and received the “customer copy”, please contact your dealer immediately. **NO WARRANTY COVERAGE WILL BE ALLOWED UNLESS YOUR ATV IS REGISTERED WITH POLARIS.**

Initial dealer preparation and set-up of your ATV is very important in ensuring trouble-free operation. Purchasing a machine in the crate or without proper dealer set-up will void your warranty coverage.

## **WARRANTY COVERAGE AND EXCLUSIONS: LIMITATIONS OF WARRANTIES AND REMEDIES**

The Polaris limited warranty excludes any failures that are not caused by a defect in material or workmanship. This warranty does not cover accidental damage, normal wear and tear, abuse or improper handling. This warranty also does not cover any ATV that has been altered structurally, modified, neglected, improperly maintained, used for racing, or used for purposes other than for which it was manufactured, or for any damages which occur during trailer transit or as a result of unauthorized service or the use of unauthorized parts. In addition, this warranty does not cover physical damage to paint or finish, stress cracks, tearing or puncturing of upholstery material, corrosion, or defects in parts, components or the ATV due to fire, explosions or any other cause beyond Polaris' control.

This warranty does not cover the use of unauthorized lubricants, chemicals, or fuels that are not compatible with the ATV. The exclusive remedy for breach of this warranty shall be, at Polaris' exclusive option, repair or replacement of any defective materials, or components or products. **THE REMEDIES SET FORTH IN THIS WARRANTY ARE THE ONLY REMEDIES AVAILABLE TO ANY PERSON FOR BREACH OF THIS WARRANTY. POLARIS SHALL HAVE NO LIABILITY TO ANY PERSON FOR INCIDENTAL, CONSEQUENTIAL OR SPECIAL DAMAGES OF ANY DESCRIPTION, WHETHER ARISING OUT OF EXPRESS OR IMPLIED WARRANTY OR ANY OTHER CONTRACT, NEGLIGENCE, OR OTHER TORT OR OTHERWISE.** Some states do not permit the exclusion or limitation of incidental or consequential damages or implied warranties, so the above limitations or exclusions may not apply to you if inconsistent with controlling state law.

# Warranty

## **WARRANTY COVERAGE AND EXCLUSIONS:**

### **LIMITATIONS OF WARRANTIES AND REMEDIES**

ALL IMPLIED WARRANTIES (INCLUDING BUT NOT LIMITED TO THE IMPLIED WARRANTIES OF MERCHANTABILITY AND FITNESS FOR A PARTICULAR PURPOSE) ARE LIMITED IN DURATION TO THE ABOVE SIX MONTH WARRANTY PERIOD. POLARIS FURTHER DISCLAIMS ALL EXPRESS WARRANTIES NOT STATED IN THIS WARRANTY. Some states do not allow limitations on how long an implied warranty lasts, so the above limitation may not apply to you if inconsistent with controlling state law.

## HOW TO OBTAIN WARRANTY SERVICE

If your ATV requires warranty service, you must take it to a Polaris dealer authorized to repair Polaris ATVs. When requesting warranty service you must present your copy of the Warranty Registration form to the dealer. (THE COST OF TRANSPORTATION TO AND FROM THE DEALER IS YOUR RESPONSIBILITY). Polaris suggests that you use your original selling dealer; however, you may use any Polaris Servicing Dealer to perform warranty service.

Please work with your dealer to resolve any warranty issues. Should your dealer require any additional assistance they will contact the appropriate personnel at Polaris.

This warranty gives you specific legal rights, and you may also have other rights which vary from state to state.

If any of the above terms are void because of state or federal law, all other warranty terms will remain in effect.

### Engine Oil

1. Mixing oil brands or using non-recommended oil may cause engine damage. We recommend the use of Polaris engine oil.
2. Damage resulting from the use of non-recommended lubricants may not be covered by warranty.

### Spark Arrestor

Polaris warrants that the spark arrestor in this vehicle will meet the efficiency requirements of 43 CFR 8340.1(c) for at least 1000 hours when subjected to normal use and when maintenance and installation are in accordance with Polaris recommendations.

# Warranty

## EXPORTED VEHICLES

EXCEPT WHERE SPECIFICALLY REQUIRED BY LAW, THERE IS NO WARRANTY OR SERVICE BULLETIN COVERAGE ON THIS VEHICLE IF IT IS SOLD OUTSIDE THE COUNTRY OF THE SELLING DEALER'S AUTHORIZED LOCATION.

This policy does not apply to vehicles that have received authorization for export from Polaris Industries. Dealers may not give authorization for export. You should consult an authorized dealer to determine this vehicle's warranty or service bulletin coverage if you have any questions.

This policy does not apply to vehicles registered to government officials or military personnel on assignment outside the country of the selling dealer's authorized location.

This policy does not apply to Safety Recalls.

## EXPORTED VEHICLES

### How to Get Service

#### *In the country where your vehicle was purchased:*

Warranty or Service Bulletin repairs must be done by an authorized Polaris dealer. If you move or are traveling within the country where your vehicle was purchased, Warranty or Service Bulletin repairs may be requested from any authorized Polaris dealer who sells the same line as your vehicle.

#### *Outside the country where your vehicle was purchased:*

If you are traveling temporarily outside the country where your vehicle was purchased, you should take your vehicle to an authorized Polaris dealer. You must show the dealer photo identification from the country of the selling dealer's authorized location as proof of residence. Upon residence verification, the servicing dealer will be authorized to perform the warranty repair.

#### *If You Move:*

If you move to another country, be sure to contact Polaris Customer Assistance and the customs department of the destination country before you move. Vehicles importation rules vary considerably from country to country. You may be required to present documentation of your move to Polaris Industries in order to continue your warranty coverage. You may also be required to obtain documentation from Polaris Industries in order to register your vehicle in your new country.



# Warranty

## EXPORTED VEHICLES

### How to Get Service

#### *If Purchased From A Private Party:*

If you purchase a Polaris product from a private citizen outside of the country in which the vehicle was originally purchased, all warranty coverage will be denied.

### Notice

If your vehicle is registered outside of the country where it was purchased, and you have not followed the procedure set out above, your vehicle will no longer be eligible for warranty or service bulletin coverage of any kind. (Vehicles registered to Government officials or military personnel on assignment outside of the country where the vehicle was purchased will continue to be covered by the basic warranty.)

#### *For questions call Polaris Customer Assistance:*

United States: 1-888-704-5290

Canada: 1-204-925-7100

## U.S.A. EPA Emissions Limited Warranty

This All Terrain Vehicle (ATV) or Off Road Utility Vehicle (ORUV) emissions limited warranty is in addition to the Polaris standard limited warranty for this vehicle.

Polaris warrants that this vehicle is; (1) designed, built, and equipped to conform at the time of initial sale with the requirements of 40 CFR 1051 and, (2) free from defects in materials and workmanship that may keep it from meeting these requirements.

The emissions warranty period for this vehicle begins on the date the vehicle is delivered to the original retail purchaser and ends 30 months (2.5 years) after that date, after 5000 km (3100 miles), or after 500 hours of operation, whichever comes first.

This emission-related warranty covers components whose failure would increase an engine's emissions, including electronic controls, fuel injection, exhaust-gas recirculation, aftertreatment, or any other system utilized in this vehicle to control emissions. Replacing or repairing other components not covered by this emissions warranty or the standard warranty is the responsibility of the owner; including the parts, labor and other costs associated with recommended maintenance.

# Warranty

## U.S.A. EPA Emissions Limited Warranty

The exclusive remedy for breach of this limited warranty shall be, at the exclusive option of Polaris, repair or replacement of any defective materials, components or products. THE REMEDIES SET FORTH IN THIS LIMITED WARRANTY ARE THE ONLY REMEDIES AVAILABLE TO ANY PERSON FOR BREACH OF THIS WARRANTY. POLARIS SHALL HAVE NO LIABILITY TO ANY PERSON FOR INCIDENTAL, CONSEQUENTIAL OR SPECIAL DAMAGES OF ANY DESCRIPTION, WHETHER ARISING OUT OF EXPRESS OR IMPLIED WARRANTY OR ANY OTHER CONTRACT, NEGLIGENCE OR OTHER TORT OR OTHERWISE.

ALL IMPLIED WARRANTIES (INCLUDING BUT NOT LIMITED TO ANY IMPLIED WARRANTIES OF MERCHANTABILITY AND FITNESS FOR A PARTICULAR PURPOSE) ARE LIMITED IN DURATION TO THE WARRANTY PERIOD DESCRIBED HEREIN. POLARIS DISCLAIMS ALL EXPRESS WARRANTIES NOT STATED IN THIS WARRANTY. Some states do not allow limitations on how long an implied warranty lasts, so the above limitation may not apply if it is inconsistent with the controlling state law.

This limited warranty excludes failures not caused by a defect in material or workmanship. This limited warranty does not cover damage due to accidents, abuse or improper handling, maintenance or use. This limited warranty also does not cover any engine that has been structurally altered, or any engine that has been used in racing competition. This limited warranty also does not cover physical damage, corrosion or defects caused by fire, explosions or other similar causes beyond the control of Polaris.

If you have any questions regarding your warranty rights and responsibilities, you should contact the Polaris Warranty Department at 1-888-704-5290.

# Maintenance Log

Present this section of your manual to your dealer each time your vehicle is serviced. This will provide you and future owners with an accurate log of maintenance and services performed.

DATE	SERVICE INTERVAL (HOURS)	TECHNICIAN	SERVICE PERFORMED / COMMENTS
	3 Hours (Break-in)		
	15		
	30		
	45		

# Maintenance Log

DATE	SERVICE INTERVAL (HOURS)	TECHNICIAN	SERVICE PERFORMED / COMMENTS
	60		
	90		

# Maintenance Log

DATE	SERVICE INTERVAL (HOURS)	TECHNICIAN	SERVICE PERFORMED / COMMENTS

# Maintenance Log

DATE	SERVICE INTERVAL (HOURS)	TECHNICIAN	SERVICE PERFORMED / COMMENTS

# Index

## A

- Age Restrictions . . . . . 14
- Air Filter Systems . . . . . 122

## B

### Battery

- Charging . . . . . 146-148
- Installation . . . . . 145
- Maintenance . . . . . 143
- Removal . . . . . 144
- Storage . . . . . 144, 177
- Bleeding the Cooling System . . . 121
- Boots . . . . . 13
- Brake Fluid . . . . . 60-61
- Brake Light Adjustment . . . . . 132
- Brake Maintenance . . . . . 156-157
- Brakes**
  - Foot Brake . . . . . 58
  - Hand Brake . . . . . 59
  - Parking Brake . . . . . 62-63
- Break-in Period . . . . . 70-71

## C

- Cab Removal, Front . . . . . 133
- Cab Removal, Rear . . . . . 134
- Camber and Caster . . . . . 165
- Carburetor . . . . . 123-125
- Carburetor Draining . . . . . 125
- Carburetor Jetting . . . . . 126
- Chain Tension Adjustment . . . 162-163
- Chain Tension Inspection . . . 160-161
- Choke . . . . . 70
- Cleaning . . . . . 172-175
- Clothing . . . . . 13
- Clutch Fluid . . . . . 55
- Clutch Lever . . . . . 54
- Clutch System Bleeding . . . . 152-153
- Compression Damping . . . . . 167
- Compression Damping, Rear . . . 171
- Consumer Product Safety . . . . . 22
- Coolant Level, Radiator . . . . . 120
- Coolant Level, Recovery Bottle . . 119
- Cooling System . . . . . 118-121
- Cooling System Bleeding . . . . . 121

## D

- Deceleration . . . . . 67
- Driving Across Hillside . . . . . 84-85
- Driving Downhill . . . . . 88
- Driving in Reverse . . . . . 92-93
- Driving on Slippery Surfaces . . 80-81
- Driving Over Obstacles . . . . . 94
- Driving Procedure . . . . . 78
- Driving Through Water . . . . . 90-91
- Driving Uphill . . . . . 82-83

## E

- Electronic Throttle Control . . . . . 57
- Emission Control Systems . . . . 95-96
- Engine Idle Speed . . . . . 123-124
- Equipment Modifications . . . . . 23
- Eye Protection . . . . . 13



# Index

## F

<b>Fluid</b>	
Brake	60-61
Clutch	55
Foot Brake	58
Foot Brake Fluid Level	61
Fuel Filter	68
Fuel Stabilizer	179
Fuel System	74
Fuel Tank	68
Fuel Valve	69

## G

Gloves	13
--------	----

## H

Hand Brake	59
Hand Brake Fluid Level	61
Handlebar Adjustment	164
Headlight Adjustment	128
Headlight Assembly	130-131
Headlights	53
Helmet	12

## I-J-K

Idle Speed	123-124
Indicator Lights	52
Jetting	126
Jetting, Outlaw 425 S	183
Jetting, Outlaw 525 S	185
Key Switch	51
K-Turn	86

## L

<b>Lights</b>	<b>52-53, 127-132</b>
Brake Light	132
Headlight Adjustment	128
Headlight Assembly	130-131
Headlights	53
Indicator Lights	52

## M

Main Key Switch	51
Maintenance Chart	97-107
Making Turns	79
Manual Shift	64-67
Master Cylinder	60-61
Modifications	23

## O

Oil Change, Engine	110-117
Oil Level, Engine	109
Oil Recommendations	108
Operator Restrictions	14
Operator Safety	14-49

## P

Parking Brake	62-63
Parking on a Hill or Incline	89
Passenger Warning	11
Periodic Maintenance Chart	97-107
Polaris Products	186
Polishing	176
Pre-Ride Inspection	72-73

## R

Rebound Damping, Rear	170
Restrictions	14
Reverse Lock-Out Switch	66
Riding Gear	12-13

# Index

## S

### Safety Decals

- Age 16 Warning . . . . . 10
- Discretionary Warning . . . . . 10
- General Warning . . . . . 9
- No Passenger Warning . . . . . 11
- Sport ATV Warning . . . . . 10
- Tire Pressure/Load Warning . . . . . 11
- Safety Training . . . . . 15
- Severe Use . . . . . 97
- Shift Pedal . . . . . 64
- Shifting Gears . . . . . 65
- Side Panel Removal . . . . . 134
- Signal words . . . . . 16
- Spark Arrestor Clean-Out . . . . . 138-139
- Spark Plug Removal . . . . . 137
- Spark Plugs . . . . . 135-137
- Spring Preload . . . . . 167
- Spring Preload, Front . . . . . 168
- Spring Preload, Rear . . . . . 169
- Starting the Engine . . . . . 75-77
- Steering Inspection . . . . . 165

## S

- Storage . . . . . 177-180

### Suspension

- Front . . . . . 167-168
- Rear . . . . . 169-171
- Suspension Settings . . . . . 166

### Switches

- Engine Stop Switch . . . . . 51
- Main Key Switch . . . . . 51
- Reverse Lock-Out Switch . . . . . 66
- Start Button . . . . . 51

## T

- Throttle Cable Freeplay . . . . . 155
- Throttle Lever . . . . . 56-57
- Throttle Lever Freeplay . . . . . 154

### Tires

- Installation . . . . . 151
- Removal . . . . . 150
- Tread Depth . . . . . 149
- Wheel Hub Tightening . . . . . 150

## T

- Toe Alignment . . . . . 158-159
- Transporting the ATV . . . . . 181
- Turning Around on a Hill . . . . . 86-87

## V

- Vehicle Immersion . . . . . 140-142

## W

- Warranty, Emissions . . . . . 207-208
- Washing the Vehicle . . . . . 173-175
- Wheel Hub Tightening . . . . . 150
- Wheel Installation . . . . . 151
- Wheel Removal . . . . . 150

## Free Manuals Download Website

<http://myh66.com>

<http://usermanuals.us>

<http://www.somanuals.com>

<http://www.4manuals.cc>

<http://www.manual-lib.com>

<http://www.404manual.com>

<http://www.luxmanual.com>

<http://aubethermostatmanual.com>

Golf course search by state

<http://golfingnear.com>

Email search by domain

<http://emailbydomain.com>

Auto manuals search

<http://auto.somanuals.com>

TV manuals search

<http://tv.somanuals.com>