

POLARIS®
The Way Out.



Sportsman 6X6

Owner's Manual for Maintenance and Safety

Read this manual carefully. It contains important safety information.

This is an adult vehicle only.

Operation is prohibited for those under 16 years of age.

WARNING

Improper vehicle use can result in SEVERE INJURY or DEATH.

NEVER:

- **Operate on public roads.** A collision can occur with another vehicle.
- **Carry passengers.** Passengers affect balance and steering and increase risk of losing control.
- **USE ALCOHOL or DRUGS** before or while operating this vehicle.
- **Operate at speeds too fast for your skills or the conditions.**
- **Operate this vehicle on HILLS** steeper than 25 degrees. To prevent flipover on hilly terrain, use throttle and brakes gradually.

ALWAYS:

- **Use an approved HELMET AND PROTECTIVE GEAR.**
- **Avoid paved surfaces.** Pavement may seriously affect handling and control.
- **Use proper RIDING TECHNIQUES** to avoid vehicle overturns on hills and rough terrain and in turns.
- **Use OVERRIDE** for reverse speed limiter with caution. To prevent loss of control, never activate override button with open throttle.

REVERSE operation can be dangerous, even at low speeds. Steering becomes difficult. To prevent flipover, avoid sharp turns.

PARKING BRAKE may relax when used for more than 5 minutes. When parking on grades, leave shift in forward.

LOCATE AND READ OWNER'S MANUAL.

FOLLOW ALL INSTRUCTIONS AND WARNINGS.



For your nearest Polaris dealer,
call 1-800-POLARIS
or visit www.polarisindustries.com
Polaris Sales Inc.,
2100 Hwy. 55, Medina, MN 55340
Phone 1-888-704-5290
Part No. 9922027 Rev 02
Printed in USA

⚠ WARNING

The engine exhaust from this product contains chemicals known to the State of California to cause cancer, birth defects or other reproductive harm.

WELCOME

Thank you for purchasing a Polaris vehicle, and welcome to our world-wide family of Polaris owners. We proudly produce an exciting line of utility and recreational products.

- Snowmobiles
- All-terrain vehicles (ATVs)
- *RANGER* utility vehicles
- Victory motorcycles

We believe Polaris sets a standard of excellence for all utility and recreational vehicles manufactured in the world today. Many years of experience have gone into the engineering, design, and development of your Polaris vehicle, making it the finest machine we've ever produced.

For safe and enjoyable operation of your vehicle, be sure to follow the instructions and recommendations in this owner's manual. Your manual contains instructions for minor maintenance, but information about major repairs is outlined in the Polaris Service Manual and should be performed only by a Factory Certified Master Service Dealer (MSD) Technician.

Your Polaris dealer knows your vehicle best and is interested in your total satisfaction. Be sure to return to your dealership for all of your service needs during, and after, the warranty period.

We also take great pride in our complete line of apparel, parts and accessories, available through our online store at www.purepolaris.com. Have your accessories and clothing delivered right to your door!



POLARIS and POLARIS THE WAY OUT are registered trademarks of Polaris Industries Inc.

Copyright 2008 Polaris Sales Inc. All information contained within this publication is based on the latest product information at the time of publication. Due to constant improvements in the design and quality of production components, some minor discrepancies may result between the actual vehicle and the information presented in this publication. Depictions and/or procedures in this publication are intended for reference use only. No liability can be accepted for omissions or inaccuracies. Any reprinting or reuse of the depictions and/or procedures contained within, whether whole or in part, is expressly prohibited.

Printed in U.S.A.

2009 Sportsman 800 6X6 Owner's Manual

P/N 9922027

TABLE OF CONTENTS

Introduction	4
Safety	7
Features and Controls	26
Operation	46
Emission Control Systems	66
Maintenance	67
Adjustments	116
Troubleshooting	118
Specifications	122
Polaris Products	124
Warranty	125
Maintenance Log	131
Index	134

INTRODUCTION

The following signal words and symbols appear throughout this manual and on your vehicle. Your safety is involved when these words and symbols are used. Become familiar with their meanings before reading the manual.



The safety alert symbol indicates a potential personal injury hazard.

WARNING

A **WARNING** indicates a hazardous situation which, if not avoided, may result in death or serious injury.

CAUTION

A **CAUTION** indicates a hazardous situation which, if not avoided, may result in minor or moderate injury.

NOTICE

A **NOTICE** indicates a situation that may result in property damage.



The Prohibition Safety Sign indicates an action **NOT** to take in order to avoid a hazard.



The Mandatory Action Sign indicates an action that **NEEDS** to be taken to avoid a hazard.

INTRODUCTION

WARNING

Failure to heed the warnings and safety precautions contained in this manual can result in severe injury or death. This Polaris vehicle is not a toy and can be hazardous to operate. This vehicle handles differently than other vehicles, such as motorcycles and cars. A collision or rollover can occur quickly, even during routine maneuvers like turning, or driving on hills or over obstacles, if you fail to take proper precautions.

- Read this owner's manual. Understand all safety warnings, precautions and operating procedures before operating this vehicle. Keep this manual with the vehicle.
- Never operate this vehicle without proper instruction. Take a training course. Purchasers of a new Polaris vehicle and their eligible family members are entitled to take the *ATV RiderCourse*sm. Contact ATV Enrollment Express at (800) 887-2887 or visit www.atvsafety.org for information on enrollment in the *ATV RiderCourse*sm.
- This vehicle is an **ADULT VEHICLE ONLY**. Operation is prohibited for anyone under 16 years of age.
- Never permit a guest to operate this vehicle unless the guest has read this manual and all product labels and has completed a certified safety training course.

INTRODUCTION

Vehicle Identification Numbers

Record your vehicle's identification numbers and key number in the spaces provided. Remove the spare key and store it in a safe place. An ignition key can be duplicated only by ordering a Polaris key blank (using your key number) and mating it with one of your existing keys. The ignition switch must be replaced if all keys are lost.

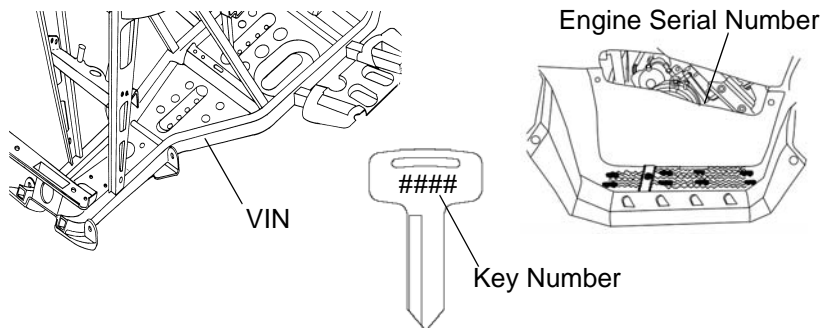

Vehicle Model Number: _____

Frame VIN: _____

Engine Serial Number: _____

Key Number: _____

Safety Training

Safety training is a top priority for Polaris. When you purchased your new vehicle, your dealer instructed you on the authorized *ATV RiderCourse*sm available to you and your eligible family members. This training is included in the purchase price of your vehicle. Polaris strongly encourages you and your eligible family members who will be riding this vehicle to take the *ATV RiderCourse*sm. You were also provided with printed materials that explain safe operating procedures. You should review this information on a regular basis.

If you purchased a used Polaris vehicle, you can take the *ATV RiderCourse*sm by calling ATV Enrollment Express at (800) 887-2887 or by visiting www.atvsafety.org. Purchasers of a used Polaris vehicle will be charged for this training.

This Polaris vehicle is an off-road vehicle. Familiarize yourself with all laws and regulations concerning the operation of this vehicle in your area.

We strongly advise you to strictly follow the recommended maintenance program outlined in your owner's manual. This preventive maintenance program is designed to ensure that all critical components on your vehicle are thoroughly inspected at specific intervals.

FOR MORE INFORMATION ABOUT ATV SAFETY, call the Consumer Product Safety Commission at 1-800-638-2772, or visit www.cpsc.gov, visit www.atvsafety.org, or call Polaris at 1-800-342-3764.

SAFETY

Safe Riding Gear

Always wear appropriate clothing when riding this vehicle. Wear protective clothing for comfort and to reduce the chance of injury.

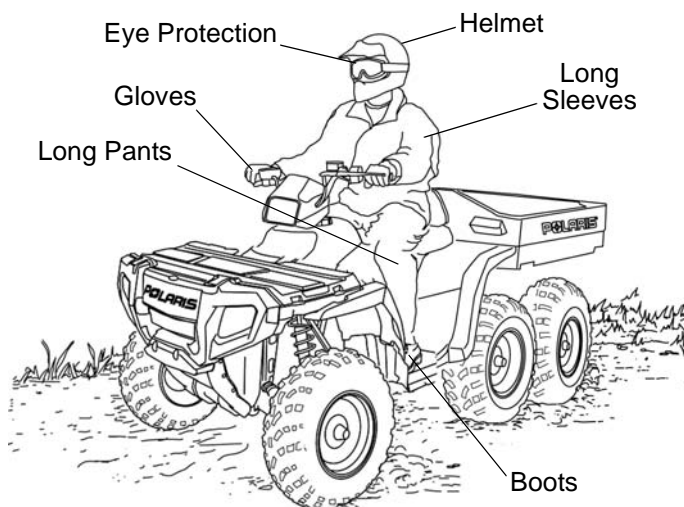

Helmet

Wearing a helmet can prevent a severe head injury. Whenever riding a Polaris vehicle, always wear a helmet that meets or exceeds established safety standards.

Approved helmets in the USA and Canada bear a U.S. Department of Transportation (DOT) label.

Approved helmets in Europe, Asia and Oceania bear the ECE 22.05 label. The ECE mark consists of a circle surrounding the letter E, followed by the distinguishing number of the country which has granted approval. The approval number and serial number will also be displayed on the label.

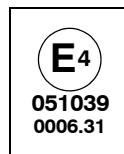

Safe Riding Gear

Eye Protection

Do not depend on eyeglasses or sunglasses for eye protection. Whenever riding a Polaris vehicle, always wear shatterproof goggles or use a shatterproof helmet face shield. Polaris recommends wearing approved Personal Protective Equipment (PPE) bearing markings such as VESC 8, V-8, Z87.1, or CE. Make sure protective eye wear is kept clean.

Gloves

Off-road style gloves with knuckle pads are the best for comfort and protection.

Boots

The best footwear is a pair of sturdy over-the-calf boots with low heels.

Clothing

Always wear long sleeves and long pants to protect arms and legs. Riding pants with kneepads and a jersey with shoulder pads provide the best protection.

Equipment Modifications

We strongly recommend that consumers do not install on a Polaris vehicle any equipment that may increase the speed or power of the vehicle, or make any other modifications to the vehicle for these purposes.

The warranty on your Polaris vehicle is terminated if any equipment has been added to the vehicle, or if any modifications have been made to the vehicle, that increase its speed or power.

The addition of certain accessories, including (but not limited to) mowers, blades, tires, sprayers, or large racks, may change the handling characteristics of the vehicle. Use only Polaris-approved accessories, and familiarize yourself with their function and effect on the vehicle.

SAFETY

⚠ WARNING

Failure to operate the vehicle properly can result in a collision, loss of control, accident or overturn, which may result in serious injury or death. Heed all safety warnings outlined in this section of the owner's manual. See the OPERATION section of the owner's manual for proper operating procedures.

Operating Without Instruction

Operating this vehicle without proper instruction increases the risk of an accident. The operator must understand how to operate the vehicle properly in different situations and on different types of terrain.

Beginning and inexperienced operators should complete the recommended safety training before operating this vehicle. See page 7.

Never permit a guest to operate the vehicle unless the guest has read this manual and all product labels and has completed a certified safety training course.

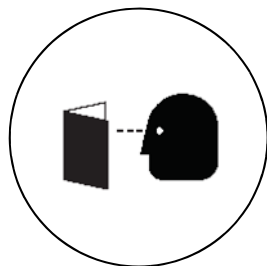

Age Restrictions

This vehicle is an **ADULT VEHICLE ONLY**. Operation is prohibited for anyone under 16 years of age.

Even though a child may be within the recommended age group for operating some Polaris vehicles, he/she may not have the skills, abilities, or judgment needed to operate this vehicle safely and could be susceptible to accident or injury.



Safety Warnings

Handling Gasoline

Gasoline is highly flammable and explosive under certain conditions.

- Always exercise extreme caution whenever handling gasoline.
- Always refuel with the engine stopped, and outdoors or in a well ventilated area.
- Do not smoke or allow open flames or sparks in or near the area where refueling is performed or where gasoline is stored.
- Do not overfill the tank. Do not fill the tank neck.
- If gasoline spills on your skin or clothing, immediately wash it off with soap and water and change clothing.

Exposure to Exhaust

Engine exhaust fumes are poisonous and can cause loss of consciousness or death in a short time. Never start the engine or let it run in an enclosed area.

The engine exhaust from this product contains chemicals known to cause cancer, birth defects or other reproductive harm. Operate this vehicle only outdoors or in well-ventilated areas.

Failure to Inspect Before Operating

Failure to inspect and verify that the vehicle is in safe operating condition before operating increases the risk of an accident.

Always inspect the vehicle before each use to make sure it's in safe operating condition.

Always follow all inspection and maintenance procedures and schedules described in the owner's manual.

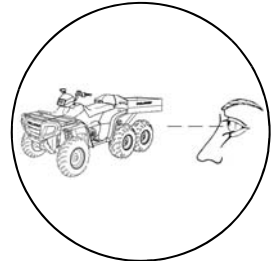

SAFETY

Safety Warnings

Protective Apparel

Riding in this vehicle without wearing an approved helmet and protective eyewear increases the risk of a serious injuries in the event of an accident.

Operator and passenger must always wear an approved helmet that fits properly and eye protection (goggles or face shield).

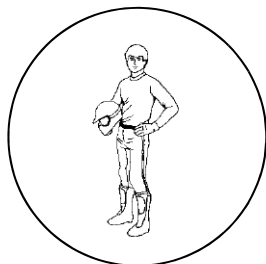

Using Alcohol or Drugs

Operating the vehicle after consuming alcohol or drugs could adversely affect operator judgment, reaction time, balance and perception.

Never consume alcohol or drugs before or while operating this vehicle.



Carrying a Passenger

Carrying a passenger greatly reduces the operator's ability to balance and control the vehicle, which may result in an accident or overturn.

Never carry a passenger on this vehicle.



Safety Warnings

Operating on Pavement

Operating this vehicle on paved surfaces (including sidewalks, paths, parking lots and driveways) may adversely affect the handling of the vehicle and could result in loss of control and accident or overturn.

Avoid operating the vehicle on pavement. The tires are designed for off-road use. If it's unavoidable, travel slowly and avoid sudden turns or stops.



Operating on Public Roads

Operating this vehicle on public streets, roads or highways could result in a collision with another vehicle.

Never operate the vehicle on any public street, road or highway, including dirt and gravel roads. In many states it's unlawful to operate this type of vehicle on public streets, roads and highways.



Operating at Excessive Speeds

Operating the vehicle at excessive speeds increases the operator's risk of losing control.

Always operate at a speed that's appropriate for the terrain, the visibility and operating conditions, and your experience.

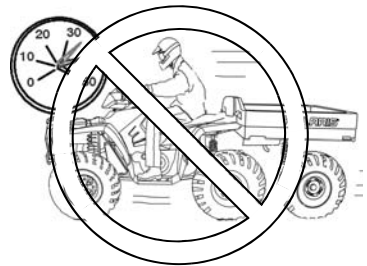

SAFETY

Safety Warnings

Physical Control of the Vehicle

Removing a hand from the handlebars or feet from the footrests during operation can reduce your ability to control the vehicle or cause loss of balance and ejection from the vehicle. If the operator's foot is not firmly planted on the footrest, it could also contact the rear wheels.

Never remove your hands from the handlebars while operating, and always keep both feet on the footrests.

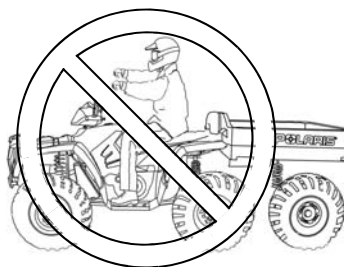

Turning Improperly

Turning improperly could cause loss of traction, loss of control, accident or overturn.

Always follow proper procedures for turning as described in the owner's manual.

Never turn abruptly or at sharp angles. Never turn at high speeds. Practice turning at slow speeds before attempting to turn at faster speeds.



Jumps and Stunts

Attempting wheelies, jumps and other stunts increases the risk of an accident or overturn.

Never attempt wheelies, jumps, or other stunts. Avoid exhibition driving.



Improper Hill Climbing

Improper hill climbing could cause loss of control or overturn. Always follow proper procedures for climbing hills as described in the owner's manual. See page 55. Always move the 4X4 switch to ADC 4X4 (if equipped) before ascending or descending a hill.

Safety Warnings

Descending Hills Improperly

Improperly descending a hill could cause loss of control or overturn.

- Always follow proper procedures for traveling down hills as described in the owner's manual. **NOTE:** A special technique is required when braking while traveling downhill. See page 57.
- Always descend a hill with the transmission in forward gear. Do not descend a hill with the transmission in neutral. Always move the 4X4 switch to ADC 4X4 (if equipped) before ascending or descending a hill. See page 36.
- Always check the terrain carefully before descending a hill.
- Shift your weight rearward.
- Never travel down a hill at high speed.
- Avoid traveling down a hill at an angle, which would cause the vehicle to lean sharply to one side. Travel straight down the hill when possible.



Crossing Hillsides

Driving on a sidehill is not recommended. Improper procedure could cause loss of control or overturn. Avoid crossing the side of any hill unless absolutely necessary.

If crossing a hillside is unavoidable, always follow proper procedures as described in the owner's manual. See page 56.

Never attempt to turn the vehicle around on any hill until you've mastered the turning technique (on level ground) as described in the owner's manual. See page 58.

SAFETY

Safety Warnings

Stalling While Climbing a Hill

Stalling, rolling backwards or improperly dismounting while climbing a hill could cause an overturn.

- Always maintain a steady speed when climbing a hill.
- Always move the 4X4 switch to ADC 4X4 (if equipped) before ascending or descending a hill. See page 36.

If all forward speed is lost:

- Keep body weight uphill.
- Apply the service brakes.
- Lock the parking brake when fully stopped.
- Dismount on uphill side, or to either side if the vehicle is pointed straight uphill.
- Turn the vehicle around and remount, following the procedure described in the owner's manual. See page 58.

If the vehicle begins rolling downhill:

- Keep body weight uphill.
- Never apply engine power.
- Never apply the rear brake while rolling backwards. Apply the service brake gradually.
- When fully stopped, apply the rear brake as well, and then lock the parking brake.
- Dismount on uphill side, or to either side if the vehicle is pointed straight uphill.
- Turn the vehicle around and remount, following the procedure described in the owner's manual. See page 58.

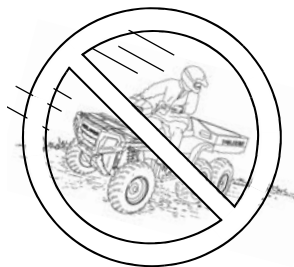

Safety Warnings

Operating on Steep Hills

Operating on excessively steep hills could cause an overturn.

Never operate on hills too steep for the vehicle or for your abilities. Never operate the vehicle on hills steeper than 25 degrees.



Operating on Slippery Terrain

Failure to use extra caution when operating on excessively rough, slippery or loose terrain could cause loss of traction, loss of control, accident or overturn.

Do not operate on excessively rough, slippery or loose terrain. Always use extra caution on rough, slippery or loose terrain.



Operating in Unfamiliar Terrain

Failure to use extra caution when operating on unfamiliar terrain could result in an accident or overturn.

Unfamiliar terrain may contain hidden rocks, bumps, or holes that could cause loss of control or overturn.

Travel slowly and use extra caution when operating on unfamiliar terrain. Always be alert to changing terrain conditions.



SAFETY

Safety Warnings

Improper Tire Maintenance

Operating this vehicle with improper tires or with improper or uneven tire pressure could cause loss of control or accident.

Always use the size and type of tires specified for your vehicle.

Always maintain proper tire pressure as described in the owner's manual and on safety labels.



Operating Over Obstacles

Improperly operating over obstacles could cause loss of control or overturn.

Before operating in a new area, check for obstacles. Avoid operating over large obstacles such as rocks and fallen trees. If unavoidable, use extreme caution and always follow proper operating procedures as outlined in this manual. See page 60.

Skidding or Sliding

Skidding or sliding can cause loss of control or overturn (if tires regain traction unexpectedly).

On slippery surfaces such as ice or loose gravel, travel slowly and use extra caution to reduce the chance of skidding or sliding. Do not operate on excessively slippery surfaces.

Safety Warnings

Improper Cargo Loading

Overloading the vehicle or carrying/towing cargo improperly may cause changes in handling, which could cause loss of control or an accident.

- Never exceed the stated load capacity for this vehicle.
- Cargo should be properly distributed and securely attached.
- Reduce speed when carrying cargo or pulling a trailer. Allow a greater distance for braking.
- Always follow the instructions in the owner's manual for carrying cargo or pulling a trailer.

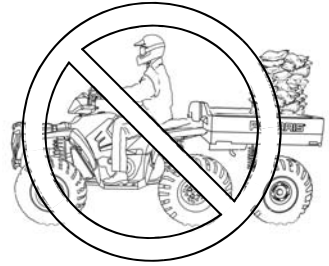

Operating Improperly in Reverse

Improperly operating in reverse could result in a collision with an obstacle or person. Always follow proper operating procedures as outlined in this manual. See page 61.

Before shifting into reverse gear, always check for obstacles or people behind the vehicle. When it's safe to proceed, back slowly.

Poor Visibility

Operating the vehicle in darkness or inclement weather could result in a collision or accident, especially if operating on a road or street. This vehicle is not equipped with highway-approved lights. Operate this vehicle off-road only. Use caution and drive at reduced speeds in conditions of reduced visibility such as fog, rain and darkness. Clean headlights frequently and replace burned out headlamps promptly.

SAFETY

Safety Warnings

Operating Through Deep Water

Operating the vehicle through deep or fast-flowing water could cause the tires to float, causing loss of control or overturn.

Avoid operating the vehicle through deep or fast-flowing water. If it's unavoidable to enter water that exceeds the recommended maximum depth (see page 59):

- Travel slowly.
- Balance your weight carefully.
- Avoid sudden movements.
- Maintain a slow and steady forward motion. Do not make sudden turns or stops, and do not make sudden throttle changes.
- Wet brakes may have reduced stopping ability. After leaving water, test the brakes. Apply them lightly several times while driving slowly. The friction will help dry out the pads.



Operating on Frozen Bodies of Water

Operating on frozen bodies of water may result in serious injury or death if the vehicle and/or the operator fall through the ice.

Never operate the vehicle on a frozen body of water.



Safety Warnings

Operating a Damaged Vehicle

Operating a damaged vehicle can result in an accident. After any overturn or accident, have a qualified service dealer inspect the entire machine for possible damage, including (but not limited to) brakes, throttle and steering systems.

Physical Skills

Safe operation of this rider-active vehicle requires good judgement and physical skills. Persons with cognitive or physical disabilities who operate this vehicle have an increased risk of overturn and loss of control.

Hot Exhaust Systems

Exhaust system components are very hot during and after use of the vehicle. Hot components can cause burns and fire. Do not touch hot exhaust system components. Always keep combustible materials away from the exhaust system. Use caution when traveling through tall grass, especially dry grass.

Unauthorized Use of the Vehicle

Leaving the keys in the ignition can lead to unauthorized use of the vehicle, which could result in an accident or overturn. Always remove the ignition key when the vehicle is not in use.

SAFETY

Safety Labels and Locations

Warning labels have been placed on the vehicle for your protection. Read and follow the instructions of the labels on the vehicle carefully. If any of the labels depicted in this manual differ from the labels on your vehicle, always read and follow the instructions of the labels on the vehicle.

If an informational or graphic label becomes illegible or comes off, contact your Polaris dealer to purchase a replacement. Replacement *safety* labels are provided by Polaris at no charge. The part number is printed on the label.

General Warning

WARNING

Improper vehicle use can result in SEVERE INJURY or DEATH

NEVER:

- Operate on public roads. A collision can occur with another vehicle.
- Carry passengers. Passengers affect balance and steering and increase risk of losing control.
- USE ALCOHOL or DRUGS before or while operating this vehicle.
- Operate at speeds too fast for your skills or the conditions.
- Operate this vehicle on HILLS steeper than 25 degrees. To prevent flipover on hilly terrain, use throttle and brakes gradually.

ALWAYS:

- Use an approved HELMET AND PROTECTIVE GEAR.
- Avoid paved surfaces. Pavement may seriously affect handling and control.
- Use proper RIDING TECHNIQUES to avoid vehicle overturns on hills and rough terrain and in turns.
- Use OVERRIDE for reverse speed limiter with caution. To prevent loss of control, never activate override button with open throttle.

REVERSE operation can be dangerous, even at low speeds. Steering becomes difficult. To prevent flipover, avoid sharp turns.

PARKING BRAKE may relax when used for more than 5 minutes. When parking on grades, leave shift in forward.

LOCATE AND READ OWNER'S MANUAL. FOLLOW ALL INSTRUCTIONS AND WARNINGS. IF OWNER'S MANUAL IS MISSING, CONTACT A POLARIS DEALER FOR A REPLACEMENT.

7175784

Safety Labels and Locations

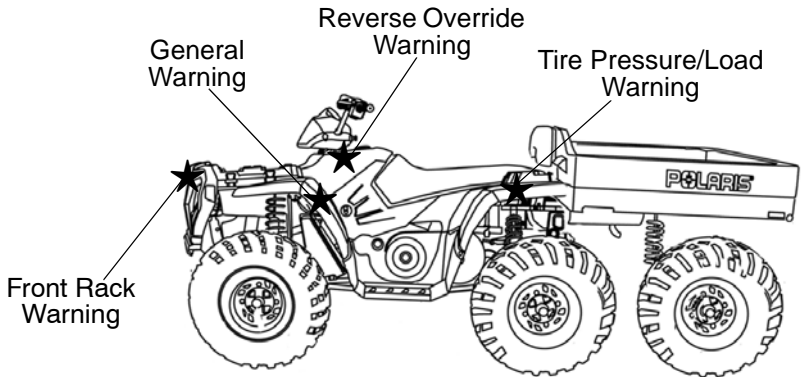

Tire Pressure/Load Warning

WARNING

Improper tire pressure or overloading can cause loss of control. Loss of control can result in severe injury or death.

- Cold tire pressure:
 - Front: 7.0 psi (48.3 kPa)
 - Center: 10.0 psi (68.9 kPa)
 - Rear: 10.0 psi (68.9 kPa)
- Maximum weight capacity: 1115 lbs. (507 kg)

7175651

Front Rack/Box Warning

WARNING

- DO NOT TOW FROM RACK OR BUMPER. Vehicle damage or tipover may result causing severe injury or death. Tow only from tow hooks or hitch.
- Max. Rack Loads: 100 lbs. (45 kg)

7175662

Reverse Override Warning

WARNING

Improper use of override button can lead to loss of control resulting in severe injury or death. Do not activate override while throttle is engaged. Always apply throttle gradually, while in reverse.

7175486

SAFETY

Safety Labels and Locations

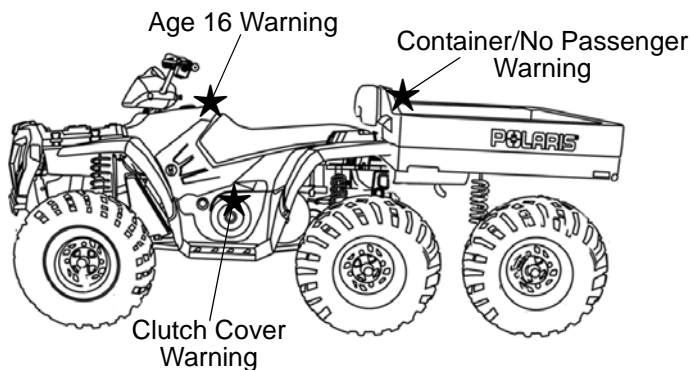

Container/No Passenger Warning

WARNING

Remove flammable containers from box before refueling.

WARNING

- Passengers can be thrown off. This can cause serious injury or death.
- Never carry passengers.

Maximum Box Load 800 lbs. (363 kg)

7079316

Safety Labels and Locations

Age 16 Warning

WARNING

Operating this ATV if you are under the age of 16 increases your chance of severe injury or death.

NEVER operate this ATV if you are under age 16.

7172588

Clutch Cover Warning

WARNING

- Moving parts hazard under belt-clutch guard. To prevent serious injury, do not operate vehicle with guard removed.
- Do not modify engine or clutch. Doing so can cause part failure, possible imbalance, and excessive engine RPM, which can result in serious injury or death.

NO STEP

7172563

Hitch Capacity Label

TRAILER MAX WEIGHT:

1500 LBS. (682 KG) ON LEVEL GROUND

850 LBS. (386 KG) UP TO 15° GRADE

HITCH MAX. VERTICAL WEIGHT: 150 LBS. (68 KG)

9921509

FEATURES AND CONTROLS

Switches

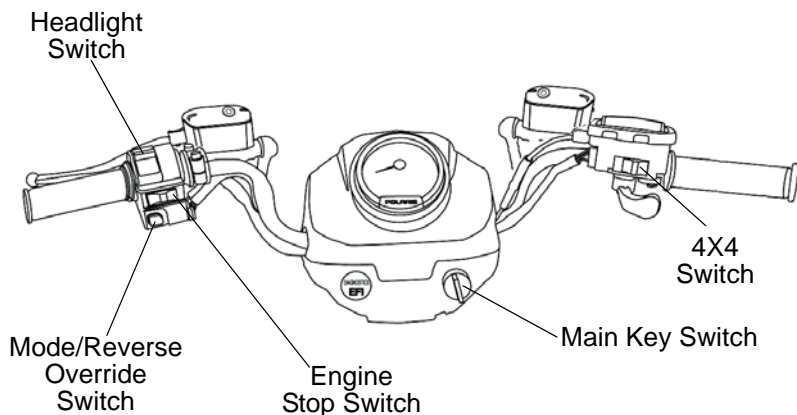

Mode/Reverse Override Switch

This vehicle is equipped with a reverse speed limiter system. To gain additional wheel speed while backing, release the throttle and depress the override button.

WARNING! Pressing the override button while the throttle is open can cause loss of control, which may result in serious injury or death. Always release the throttle before pressing the override button.

The override switch also allows activation of 4X4 in reverse, if the 4X4 switch is on. This switch is also used to toggle through the modes of the rider information center. See page 37.

All Wheel Drive (AWD) Switch

See page 34 for AWD information.

FEATURES AND CONTROLS

Switches

Engine Stop Switch

Move the stop switch either left or right to the OFF position to stop the engine quickly. The engine will not start or run when the switch is off.

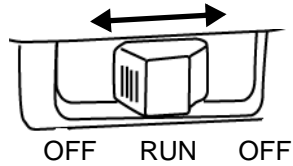

Both the main switch and the engine stop switch will shut off all electrical power to the vehicle, including lights.

Main Key Switch

Use the main key switch to start the engine. See page 51 for starting procedures.

Headlight Switch

Use the headlight switch to turn the lights on and off and to change the lights from high beam to low beam. The key must be in the ON position and the engine stop switch must be in the RUN position to operate the headlights.

FEATURES AND CONTROLS

Throttle Lever

⚠ WARNING

Operating this vehicle with sticking or improperly operating throttle controls could cause an accident. Never start or operate the vehicle if it has a sticking or improperly operating throttle. Always contact your dealer for service before operating the vehicle.

Failure to check or maintain proper operation of the throttle system can result in an accident if the throttle lever sticks during operation. Always check the lever for free movement and return before starting the engine. Also check occasionally during operation.

Modifications to the electronic throttle control could result in failure to perform as designed, which could result in an accident. Do not attempt to modify the throttle control system or replace it with any after market throttle mechanisms. Always ensure that the throttle cable is installed and properly routed to the throttle control.

Engine speed and vehicle movement are controlled by pressing the throttle lever. The throttle lever is spring loaded. Engine speed returns to idle when the lever is released.

This vehicle is equipped with Polaris Electronic Throttle Control (ETC), which is designed to reduce the risk of a frozen or stuck throttle.

If the throttle cable should stick in an open position when the operator releases the throttle lever, the engine will stop, and power to the rear wheels will cease.

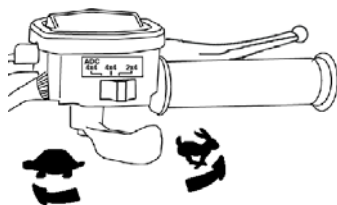

FEATURES AND CONTROLS

Brake Systems

⚠ WARNING

Aggressively applying the rear brake when backing down a hill may cause rear tipover, which could result in serious injury or death. Never back down a hill.

Use caution when applying the rear brake. Do not aggressively apply the rear brake when going forward. The rear wheels may skid and slide sideways, causing loss of control, which may result in serious injury or death.

⚠ WARNING

Operating the vehicle with a spongy brake lever can result in loss of braking, which could cause an accident. Never operate the vehicle with a spongy-feeling brake lever. Always contact your dealer for service before operating the vehicle.

The braking system is controlled by the two brake levers located on the handlebars. The service brake (left lever) is an all-wheel brake. Use the service brake for normal braking. The auxiliary brake (right lever) is a middle axle rear brake only.

FEATURES AND CONTROLS

Brake Systems

Service Brake Lever

Squeeze the service brake lever (left lever) toward the handlebar to apply the front and rear brakes. These brakes are hydraulically activated disc brakes.

Always test brake lever travel and master cylinder fluid level before riding. When squeezed, the lever should feel firm. Any sponginess would indicate a possible fluid leak or low master cylinder fluid level, which must be corrected before riding. Contact your dealer for proper diagnosis and repairs.

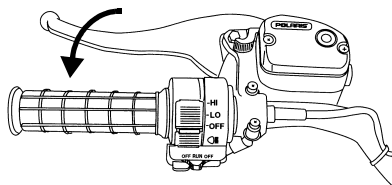

Auxiliary Brake Lever

Squeeze the auxiliary brake lever (right lever) toward the handlebar to apply the middle axle (rear brake) only.

Use the auxiliary brakes for additional braking or for backup if the service brake system fails.

If the rear wheels slide while using the auxiliary brake, *reduce* brake lever pressure to brake the rear wheels without skidding.

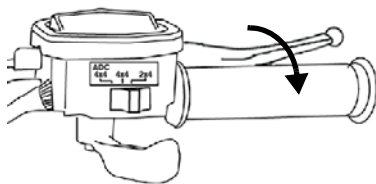

FEATURES AND CONTROLS

Master Cylinder/Brake Fluid

⚠ WARNING

An over-full master cylinder may cause brake drag or brake lock-up, which could result in an accident. Maintain brake fluid at the recommended level. Do not overfill.

Never store or use a partial bottle of brake fluid. Brake fluid is hygroscopic, meaning it rapidly absorbs moisture from the air. The moisture causes the boiling temperature of the brake fluid to drop, which can lead to early brake fade and the possibility of brake failure, which could result in an accident. After opening a bottle of brake fluid, always discard any unused portion.

The master cylinders are located on the left and right handlebars. Check the fluid levels of both master cylinders before each use of the vehicle.

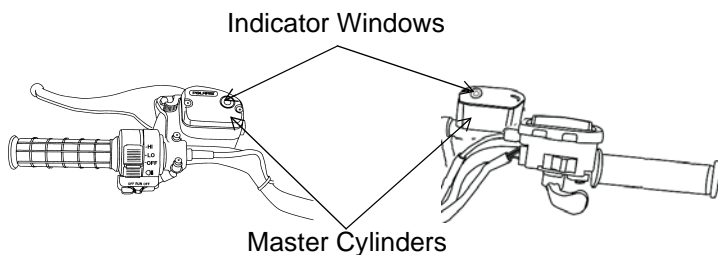

1. Position the vehicle on a level surface.
2. Position the handlebars so the master cylinders are level.
3. View the brake fluid level through the indicator window on the top of the master cylinder. The eye will appear dark when the fluid level is full. When fluid is low, the eye will be clear.
4. If the fluid level is low add DOT 4 brake fluid only. Do not overfill.

FEATURES AND CONTROLS

Parking Brake

Locking the Parking Brake

1. Place the transmission in park.
2. Squeeze and release the brake lever two or three times, then squeeze and hold.
3. Push the parking brake lock forward to engage the lock.
4. Release the brake lever.
5. To release the parking brake lock, squeeze and release the brake lever. It will return to its unlocked position.

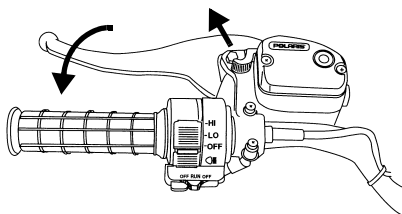

WARNING! Operating the vehicle while the parking brake is engaged could result in an accident or fire. Always check to be sure the parking brake is disengaged before operating.

The parking brake may relax if left on for a long period of time. Always block the wheels to prevent rolling. Always block the wheels on the downhill side of the vehicle if leaving it parked on a hill. Another option is to park the vehicle in a sidehill position. Never depend on the parking brake alone if the vehicle is parked on a hill. Always block the wheels to prevent rolling.

FEATURES AND CONTROLS

Automatic Transmission Gear Selector

The transmission gear selector is located on the right side of the vehicle.

H: High Gear

L: Low Gear

N: Neutral

R: Reverse

P: Park

To shift gears, brake to a complete stop. When the engine is idling, move the lever to the desired gear.

NOTICE: Shifting gears with the engine speed above idle or while the vehicle is moving could cause transmission damage.

Always place the transmission in park and lock the parking brake whenever the vehicle is left unattended.

Belt Life

To extend belt life, use low forward gear in heavy pulling situations and when operating at less than 7 mph (11 km/h) for extended periods of time.

Fuel Tank Cap

Always refuel with the engine stopped, and outdoors or in a well ventilated area. Refuel on a level surface.

Remove the fuel tank cap to add fuel to the fuel tank. Use either leaded or unleaded gasoline with a minimum pump octane number of $87 = (R + M/2)$ octane. *Do not use E-85 fuel.*

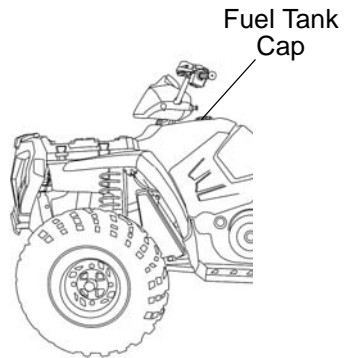

FEATURES AND CONTROLS

All Wheel Drive (AWD) System

The All Wheel Drive system is controlled by the 4X4 (AWD) switch.

ADC 4X4 Mode (if equipped)

When the switch is on ADC 4X4, the ADC system allows engine braking to all six wheels when the vehicle descends a hill or incline. Always move the 4X4 switch to ADC 4X4 before ascending or descending a hill. See page 36.

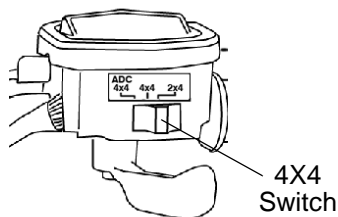

AWD Mode

When the switch is on 4X4, the vehicle is in all wheel drive, and the AWD indicator light in the instrument cluster will be on.

When in AWD, the demand drive unit will automatically engage any time the rear wheels lose traction. When the rear wheels regain traction, the demand drive unit will automatically disengage.

There is no limit to the length of time the vehicle may remain in AWD.

Tip: The override switch allows activation of AWD in reverse if the 4X4 switch is on. See page 26.

2X4 Mode

When the switch is on 2X4, the middle and rear wheels drive at all times.

FEATURES AND CONTROLS

All Wheel Drive System

Engaging AWD

The 4X4 switch may be turned on or off while the vehicle is moving. Initially, the vehicle's electronic system will not enable AWD until the engine RPM is below 3100. Once enabled, AWD remains enabled until the 4X4 switch is turned off. If the switch is turned off while the demand drive unit is moving, it will not disengage until the rear wheels regain traction.

Engage the 4X4 switch before getting into conditions where front wheel drive may be needed. If the rear wheels are spinning, release the throttle before switching to AWD.

NOTICE: Switching to 4X4 or ADC 4X4 while the rear wheels are spinning may cause severe drive shaft and gearcase damage. Always switch to 4X4 or ADC 4X4 while the rear wheels have traction or are at rest.

FEATURES AND CONTROLS

Active Descent Control (ADC) System

The ADC system (if equipped) allows engine braking to all four wheels when the vehicle descends a hill or incline. Always move the 4X4 switch to ADC 4X4 before ascending or descending a hill.

Engaging Active Descent Control

The ADC system will automatically engage when *all four* of the following conditions occur:

- The 4X4 switch must be in the ADC 4X4 position
- Vehicle speed must be 15 mph (24 km/h) or less
- The throttle must be closed (throttle lever released)
- The transmission must be in gear (high, low or reverse)

Disengaging Active Descent Control

The ADC system will automatically disengage if *at least one* of the following conditions occur:

- The 4X4 switch is moved out of the ADC 4X4 position
- Vehicle speed exceeds 15 mph (24 km/h)
- The throttle is open (throttle is applied)
- The transmission is shifted to neutral or park

FEATURES AND CONTROLS

Instrument Cluster

Your vehicle is equipped with an instrument cluster that senses vehicle speed from the right front wheel. In addition to showing vehicle speed, the speedometer needle flashes when a warning condition exists.

The instrument cluster measures distance in miles as well as hours of operation. It also includes a reverse speed limiter function that limits the vehicle's speed to approximately 7-9 mph (11-14 km/h). Refer to page 26 for additional information.

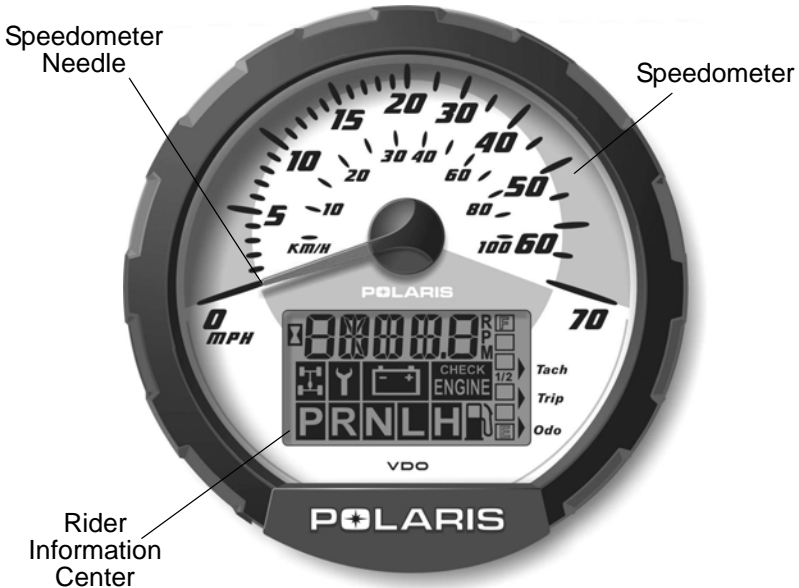

NOTICE: High water pressure may damage vehicle components. Wash the vehicle by hand or with a garden hose using mild soap.

Certain products, including insect repellents and chemicals, will damage the speedometer lens and other plastic surfaces. Do not use alcohol to clean the instrument cluster. Do not allow insect sprays to contact the lens. Immediately clean off any gasoline that splashes on the instrument cluster.

FEATURES AND CONTROLS

Instrument Cluster

Rider Information Center

The rider information center is located in the instrument cluster. All segments will light up for 2.5 seconds at start-up. If the instrument cluster fails to illuminate, a battery over-voltage may have occurred and the instrument cluster may have shut off to protect the electronic speedometer. If this occurs, take the vehicle to your Polaris dealer for proper diagnosis.

1. **Gear Indicator** - This indicator displays gear shifter position.
H = High Gear
L = Low Gear
N = Neutral
R = Reverse Gear
P = Park

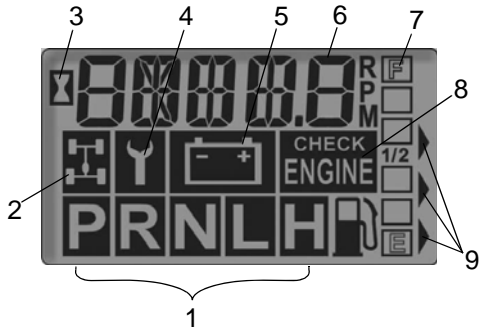

2. **4X4 Indicator** - This indicator illuminates when the 4X4 switch is on either ADC 4X4 or 4X4.
3. **Engine Hour Display Indicator**
4. **Service Interval/Diagnostic Mode Indicator**
5. **Low Battery and Over Voltage** - This warning usually indicates that the vehicle is operating at an RPM too low to keep the battery charged. It may also occur when the engine is at idle and high electrical load (lights, cooling fan, accessories) is applied. Drive at a higher RPM or recharge the battery to clear the warning.
6. **Odometer/Tachometer/Tripmeter/ Hour Meter/Clock**
7. **Fuel Gauge** - The segments of the fuel gauge show the level of fuel in the fuel tank. When the last segment clears, a low fuel warning is activated. All segments will flash, FUEL will display in the LCD, and the speedometer needle will blink. Refuel immediately.
8. **Check Engine Warning Indicator** - This indicator serves two purposes. The word HOT displays if the engine overheats. It also appears if an EFI-related fault occurs. Do not operate the vehicle if this warning appears. Serious engine damage could result.
9. **Mode Indicator**

FEATURES AND CONTROLS

Instrument Cluster

Rider Information Center

Standard Modes

Use the MODE button to toggle through the mode options. The reverse override button is also the MODE button. See page 26. The transmission cannot be in reverse when using this feature.

Odometer Mode

The odometer records the miles traveled by the vehicle.

Trip Meter Mode

The trip meter records the miles traveled by the vehicle on each trip if it's reset before each trip. To reset the trip meter, select the trip meter mode. Press and hold the mode button (override button) until the total changes to 0. In the Rider Information Center, the trip meter display contains a decimal point, but the odometer displays without a decimal point.

Hour Meter Mode

This mode logs the total hours the engine has been in operation.

Tachometer Mode

The engine RPM is displayed digitally. Small fluctuations in the RPM from day to day may be normal because of changes in humidity, temperature and elevation.

Clock Mode

The clock displays time in a 12-hour format. To reset the clock, see page 40.

FEATURES AND CONTROLS

Instrument Cluster

Rider Information Center

Diagnostic Mode

The wrench icon will display when the gauge is in the diagnostic mode. To exit the diagnostic mode, turn the key switch off and on. Any movement of the tires will also cause the gauge to exit the diagnostic mode.

To enter the diagnostics mode:

1. Turn the key switch off and wait 10 seconds.
2. Lock the parking brake.
3. Place the transmission in neutral.
4. Hold the mode/reverse override button and turn the key switch on. Release the switch as soon as the display is activated.
5. Use the mode button to toggle through the diagnostic screens.

Clock Screen

To reset the clock:

1. Enter the diagnostic mode.
2. Toggle to the clock screen.
3. Press and hold the mode button until the hour display flashes. Release the button.
4. Press and release the mode button once to advance the setting by one hour. Press and *hold* the mode button to advance the hours quickly.
5. When the desired hour is displayed, wait approximately four seconds, until the minute display flashes.
6. Use the same procedure to reset the minutes.
7. When the display stops flashing, the mode has been set.
8. Do not turn the key switch off until the display stops flashing or the new setting will not be locked into the memory.

FEATURES AND CONTROLS

Instrument Cluster

Rider Information Center

Diagnostic Mode

Battery Voltage Screen

View this screen to check battery voltage level.

Tachometer Screen

View the tachometer to check engine speed.

4X4 Diagnostic Screen

The gauge indicates whether or not current is flowing through the all-wheel-drive coil. This screen is for informational purposes only. Please see your dealer for all major repairs.

Gear Circuit Diagnostic Screen

This screen displays the resistance value (in ohms) being read at the gear switch input of the gauge. This screen is for informational purposes only. Please see your dealer for all major repairs.

Programmable service interval

When the hours of engine operation equal the programmed service interval setting, the wrench icon will flash for 5 seconds each time the engine is started. When this feature is enabled, it provides a convenient reminder to perform routine maintenance. See page 42.

The service interval is programmed at 50 hours at the factory.

FEATURES AND CONTROLS

Instrument Cluster

Rider Information Center

Diagnostic Mode

Programmable service interval

To enable or disable the service interval:

1. Enter the diagnostic mode.
2. Toggle to the service interval screen.
3. Press and hold the mode button for about 7 seconds, until either ON or OFF appears in the Rider Information Center, depending on your preference.

To reset the service interval:

1. Enter the diagnostic mode.
2. Toggle to the service interval screen.
3. Press and hold the mode button for 2-3 seconds, until the wrench icon flashes. Release the button.
4. Press and release the mode button once to advance the setting by one hour. Press and *hold* the mode button to advance the hours quickly.
5. If you scroll past the intended number, press and hold the button until the hours cycle back to zero.
6. When the desired setting is displayed, wait until the wrench icon stops flashing. The new service interval is now programmed.

Miles/Kilometers toggle

The display in the tripmeter and odometer can be changed to display either standard or metric units of measurement.

1. Enter the diagnostic mode.
2. Toggle to the screen that displays either kilometers (KM) or miles (MP).
3. Press and hold the mode button until the letters flash, then press and release the button once. When the display stops flashing, the mode has been set.

FEATURES AND CONTROLS

Instrument Cluster

Rider Information Center

Downloading Codes

The EFI diagnostic mode is for informational purposes only. Please see your Polaris dealer for all major repairs.

See page 45 for Blink Codes and Failure Descriptions. Use the following procedure to download blink codes (failure codes) from the EFI module.

1. Place the transmission in park.
2. Stop the engine.
3. Turn the key switch to the ON position.
4. Turn the key switch off and on three times in less than five seconds, then leave the switch on. Any blink code numbers stored in the EFI module will display, one at a time, on the screen. The number "61" and the word "END" displays after all codes have been transmitted.

FEATURES AND CONTROLS

Instrument Cluster

Rider Information Center

Downloading Codes

Code Definitions

Open Load: There is a break in the wires that lead to the item listed in the chart (injector, fuel pump, etc.), or the item has failed.

Short-to-Ground: The wire is shorted to ground between the electronic control unit and the item listed in the chart.

Shorted Load: The wires leading to the item listed in the chart are shorted together, or the item has shorted internally.

Short-to-Battery: The wire leading from the item listed in the chart to the electronic control unit is shorted to a wire at battery voltage.

FEATURES AND CONTROLS

Instrument Cluster

Rider Information Center

Downloading Codes

Blink Code	Failure Description
12	BEGIN SEQUENCE
22	Throttle Position Sensor Low
22	Throttle Position Sensor High
22	Throttle Position Sensor Out of Adjustment
25	Gear Sensor Signal
31	System Voltage Low
31	System Voltage High
36	Ignition Coil A Prim/Sec Circuit Malfunction: Open Load/Short-to-Ground
36	Ignition Coil A Prim/Sec Circuit Malfunction: Shorted Load/Short-to-Battery
37	Ignition Coil B Prim/Sec Circuit Malfunction: Open Load/Short-to-Ground
37	Ignition Coil B Prim/Sec Circuit Malfunction: Shorted Load/Short-to-Battery
41	Air Temp Sensor Low Voltage
41	Air Temp Sensor High Voltage
42	Engine Coolant Temp Low Voltage
42	Engine Coolant Temp High Voltage
44	Crank Position Sensor Circuit Fault
45	Barometric Pressure/Manifold Air Pressure Sensor Low
46	Barometric Pressure/Manifold Air Pressure Sensor High
47	IAC Stepper Motor: Open Load
47	IAC Stepper Motor: Short-to-Ground
51	Injector Circuit Malfunction - Cyl 1: Open Load/Short-to-Ground
51	Injector Circuit Malfunction - Cyl 1: Shorted Load/Short-to-Battery
52	Injector Circuit Malfunction - Cyl 2: Open Load/Short-to-Ground
52	Injector Circuit Malfunction - Cyl 2: Shorted Load/Short-to-Battery
55	MIL Circuit: Open Load/Short-to-Ground
55	MIL Circuit: Shorted Load/Short-to-Battery
56	Fuel Pump: Open Load/Short-to-Ground
56	Fuel Pump: Shorted Load/Short-to-Battery
58	Fan Circuit: Open Load/Short-to-Ground
58	Fan Circuit: Shorted Load/Short-to-Battery
59	ADC: Open Load/Short-to-Ground
59	ADC: Shorted Load/Short-to-Battery
63	Starter Enable: Open Load/Short-to-Ground
63	Starter Enable: Shorted Load/Short-to-Battery
72	Gear Sensor Signal
73	4X4: Open Load/Short-to-Ground
73	4X4: Shorted Load/Short-to-Battery
74	Rear Differential Enable: Open Load/Short-to-Ground (if equipped)
74	Rear Differential Enable: Shorted Load/Short-to-Battery (if equipped)
61	END SEQUENCE

OPERATION

WARNING

Failure to operate the vehicle properly can result in a collision, loss of control, accident or overturn, which may result in serious injury or death. Read and understand all safety warnings outlined in the safety section of this owner's manual.

Break-In Period

The break-in period for your new Polaris vehicle is the first ten hours of operation, or the time it takes to use the first two full tanks of gasoline. No single action on your part is as important as following the procedures for a proper break-in. Careful treatment of a new engine and drive components will result in more efficient performance and longer life for these components.

NOTICE: Excessive heat build-up during the first three hours of operation will damage close-fitted engine parts and drive components. Do not operate at full throttle or high speeds during the first three hours of use.

Break-In Period

Engine and Drivetrain Break-in

1. Fill the fuel tank with gasoline. See page 33. Always exercise extreme caution whenever handling gasoline.
2. Check the engine oil level on the dipstick. See page 72. Add oil if necessary to maintain the level between the safe and add marks.
3. Drive slowly at first. Select an open area that allows room to familiarize yourself with vehicle operation and handling.
4. Vary the throttle positions. Do not operate at sustained idle.
5. Perform regular checks on fluid levels, controls and areas outlined on the daily pre-ride inspection checklist. See page 48.
6. Pull only light loads.
7. Change both the oil and the filter at 20 hours or one month, whichever comes first.

PVT Break-in (Clutches/Belt)

A proper break-in of the clutches and drive belt will ensure a longer life and better performance. Break in the clutches and belt by operating at slower speeds during the break-in period as recommended. Pull only light loads. Avoid aggressive acceleration and high speed operation during the break-in period.

OPERATION

Pre-Ride Checklist

Failure to inspect and verify that the vehicle is in safe operating condition before operating increases the risk of an accident. Always inspect the vehicle before each use to make sure it's in safe operating condition.

Item	Remarks	Page
Brake system/lever travel	Ensure proper operation	29 84
Brake fluid	Ensure proper level	31
Auxiliary brake	Ensure proper operation	30
ADC Fluid	Ensure proper level	80
Front suspension	Inspect, lubricate if necessary	71
Rear suspension	Inspect, lubricate if necessary	71
Steering	Ensure free operation	-
Tires	Inspect condition and pressure	87
Wheels/fasteners	Inspect, ensure fastener tightness	87 88
Frame nuts, bolts, fasteners	Inspect, ensure tightness	-
Fuel and oil	Ensure proper levels	33 72
Coolant level (if applicable)	Ensure proper level	82 83
Coolant hoses (if applicable)	Inspect for leaks	-
Throttle	Ensure proper operation	28 117
Indicator lights/switches	Ensure operation	26
Engine stop switch	Ensure proper operation	27
Air filter, pre-filter	Inspect, clean	89
Air box sediment tube	Drain deposits whenever visible	-
Headlamp	Check operation, apply Polaris dielectric grease when lamp is replaced	27 91
Brake light/tail lamp	Check operation, apply Polaris dielectric grease when lamp is replaced	95
Dump box latch	Check condition and operation of the mechanism	-
Riding gear	Wear approved helmet, goggles, and protective clothing	8

Safe Operation Practices

1. Complete the recommended safety training before operating this vehicle. See page 7.
2. Do not allow anyone under 16 years of age to operate this vehicle. Do not allow anyone with cognitive or physical disabilities to operate this vehicle.
3. Never carry a passenger on this vehicle.
4. Engine exhaust fumes are poisonous. Never start the engine or let it run in an enclosed area.
5. Before operating, learn how to use the auxiliary brake for emergency situations (if service brakes become inoperable).
6. Operate this vehicle off-road only. Never operate the vehicle on pavement or on any public street, road or highway, including dirt and gravel roads.
7. Use caution and drive at reduced speeds in conditions of reduced visibility such as fog, rain and darkness. Clean headlights frequently and replace burned out headlamps promptly.
8. Drive in a manner appropriate for your skills and operating conditions. Never operate at excessive speeds. Never attempt wheelies, jumps, or other stunts. Never remove your hands from the handlebars while operating, and always keep both feet on the footrests.
9. Never consume alcohol or drugs before or while operating this vehicle.
10. Always use the size and type of tires specified for your vehicle. Always maintain proper tire pressure.
11. Never operate a damaged vehicle. After any overturn or accident, have a qualified service dealer inspect the entire machine for possible damage.
12. Never operate the vehicle on a frozen body of water.
13. Do not touch hot exhaust system components. Always keep combustible materials away from the exhaust system.
14. Always remove the ignition key when the vehicle is not in use to prevent unauthorized use.

OPERATION

Know Your Riding Area/Tread Lightly

Familiarize yourself with all laws and regulations concerning the operation of this off-road vehicle in your area. Respect the environment in which you ride. Find out where the designated riding areas are by contacting your Polaris dealer, a local riding club or local officials.

Help keep our trails open for recreational vehicle use. As an off-road enthusiast, you represent the sport and can set a good example (or a poor example) for others to follow. Tread lightly. Operate with respect for the terrain, avoid littering, and always stay on the designated trails.

Trail Etiquette

Always practice good etiquette when riding. Allow a safe distance between your vehicle and other vehicles operating in the same area. Communicate to oncoming operators by signaling the number of vehicles in your group. When stopping, move your vehicle to the edge of the trail as far as possible to allow others to pass safely.

Starting the Engine

1. Position the vehicle on a level surface outdoors or in a well-ventilated area.
2. Place the transmission in park.
3. Lock the parking brake.

Tip: The starter interlock will prevent the engine from starting if the transmission is in gear and the brake is not engaged.

4. Sit on the vehicle and move the engine stop switch to RUN.
5. Do not press the throttle while starting the engine.
6. Turn the ignition key past the ON position to engage the starter. Activate the starter for a maximum of five seconds, releasing the key when the engine starts.
7. If the engine does not start, return the key to the OFF position and wait five seconds before attempting to start again. Activate the starter for another five seconds if necessary. Repeat this procedure until the engine starts.

NOTICE: Operating the vehicle immediately after starting could cause engine damage. Allow the engine to warm up for several minutes before operating the vehicle.

Cold Weather Operation

If the vehicle is used year-round, check the oil level frequently. A rising oil level could indicate the accumulation of contaminants such as water or excess fuel in the bottom of the crankcase. Water in the bottom of the crankcase can lead to engine damage and must be drained. Water accumulation increases as outside temperature decreases.

See your Polaris dealer for engine heater kits, which provide quicker warm-ups and easier starting in colder weather.

OPERATION

Driving Procedures



1. Wear a helmet and eye protection. See page 8.
2. Sit upright with both feet on the footrests and both hands on the handlebars.
3. Start the engine and allow it to warm up.
4. Shift the transmission into gear.
5. Check your surroundings and determine your path of travel.
6. Release the parking brake.
7. Slowly depress the throttle with your right thumb and begin driving.
8. Drive slowly. Practice maneuvering and using the throttle and brakes on level surfaces.

Turning the Vehicle

Your vehicle is equipped with a solid rear axle, which drives both rear wheels equally at all times. This means that the wheel on the outside of the turn must travel a greater distance than the inside wheel when turning and the inside tire must slip traction slightly.

To turn, steer in the direction of the turn, leaning your upper body to the inside of the turn while supporting your weight on the outer footrest. This technique alters the balance of traction between the rear wheels, allowing the turn to be made smoothly. The same leaning technique should be used for turning in reverse.

Practice making turns at slow speeds before attempting to turn at faster speeds.

WARNING! Turning improperly can result in vehicle overturn. Never turn abruptly or at sharp angles. Never turn at high speeds.



OPERATION

Driving on Slippery Surfaces

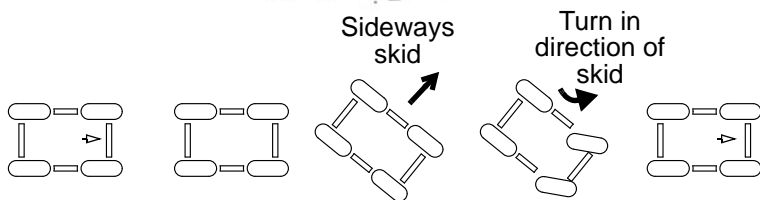

Whenever riding on slippery surfaces such as wet trails or loose gravel, or during freezing weather, follow these precautions:

1. Do not operate on excessively rough, slippery or loose terrain.
2. Slow down when entering slippery areas.
3. Engage 4X4 before wheels begin to lose traction.

NOTICE: Severe damage to drive train may occur if the 4X4 is engaged while the wheels are spinning. Allow the rear wheels to stop spinning before engaging 4X4, or engage 4X4 before wheels begin to lose traction.

4. Maintain a high level of alertness, reading the trail and avoiding quick, sharp turns, which can cause skids.
5. Never apply the brakes during a skid. Correct a skid by turning the handlebars in the direction of the skid and shifting your body weight forward.

Driving Uphill

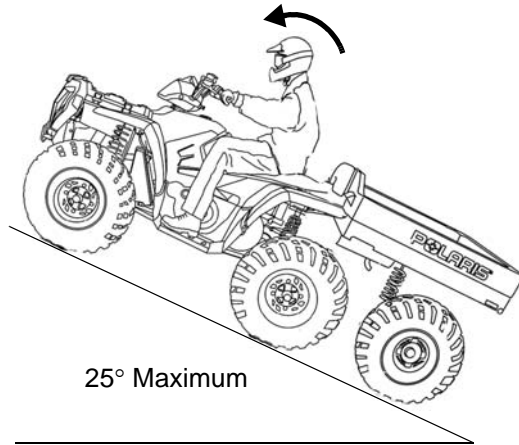

Braking and handling are greatly affected when operating in hilly terrain. Improper procedure could cause loss of control or overturn. Whenever traveling uphill, follow these precautions:

1. Always move the 4X4 switch to ADC 4X4 (if equipped) before ascending or descending a hill. See page 36.
2. Drive straight uphill.
3. Avoid steep hills (25° maximum).
4. Always check the terrain carefully before ascending any hill.
5. Never climb hills with excessively slippery or loose surfaces.
6. Keep both feet on the footrests.
7. Shift body weight uphill.
8. Proceed at a steady rate of speed and throttle opening. Opening the throttle suddenly could cause the vehicle to flip over backwards.
9. Remain alert and be prepared to take emergency action. This may include quick dismounting of the vehicle.

OPERATION

Driving on a Sidehill (Sidehilling)



Driving on a sidehill is not recommended. Improper procedure could cause loss of control or overturn. Avoid crossing the side of any hill unless absolutely necessary.

If crossing a sidehill is *unavoidable*, follow these precautions:

1. Slow down.
2. Avoid crossing the side of a steep hill.
3. Shift body weight uphill.
4. Keep your feet on the footrests.
5. If the vehicle begins to tip, quickly turn the front wheel downhill, if possible, or dismount on the uphill side *immediately*!

Driving Downhill



When driving downhill, follow these precautions:

1. Always move the 4X4 switch to ADC 4X4 (if equipped) before ascending or descending a hill. See page 36.
2. Avoid steep hills (25° maximum).
3. Shift body weight uphill.
4. Drive straight downhill.
5. Slow down. Excessive speed when traveling downhill can cause loss of control.
6. Squeeze the brake lever gradually. Applying the brakes too firmly may cause the rear wheels to lock, which could result in loss of control.

OPERATION

Turning Around on a Hill (K-Turn)

If the vehicle stalls while climbing a hill, never back it down the hill!
Use the K-turn to turn around.

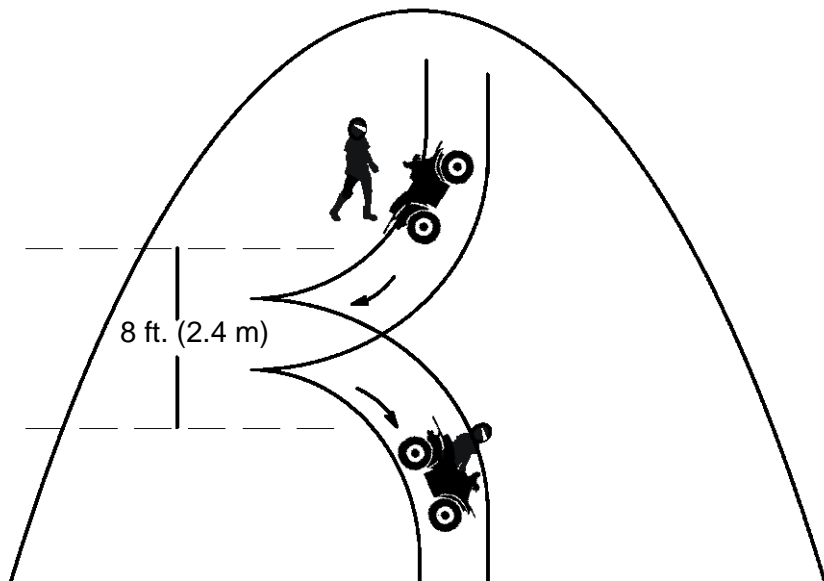

1. Stop and lock the parking brake while keeping body weight uphill.
2. Always move the 4X4 switch to ADC 4X4 (if equipped) before ascending or descending a hill. See page 36.
3. Leave the transmission in forward and shut off the engine.
4. Dismount on the uphill side of the vehicle, or on the left if the vehicle is pointing straight uphill.
5. Staying uphill of the vehicle, turn the handlebars full left.
6. While holding the service brake, release the parking brake lock and slowly allow the vehicle to roll around to your right until it's pointing across the hill or slightly downward.
7. Lock the parking brake and remount the vehicle from the uphill side, keeping body weight uphill.
8. Restart the engine with the transmission still in forward.
9. Release the parking brake and proceed *slowly*, controlling speed with the service brake, until the vehicle is on more level ground.

Driving Through Water

Your vehicle can operate through water with a maximum recommended depth equal to the bottom of the footrests. Follow these procedures when operating through water:

1. Determine water depths and current before entering water.
2. Choose a crossing where both banks have gradual inclines.
3. Avoid operating through deep or fast-flowing water.



NOTICE: Major engine damage can result if the vehicle is not thoroughly inspected after operation in water. Perform the services outlined in the maintenance chart. See page 67. The following areas need special attention: engine oil, transmission oil, demand drive fluid, rear gearcase oil, and all grease fittings.

If the vehicle tips or overturns in water, or if the engine stops during or after operating in water, restarting can result in serious engine damage. Transport the vehicle to your dealer for service before restarting the engine. If this is not possible, follow the vehicle immersion inspection and drying procedures outlined on page 98, then see your dealer for service at the first opportunity.

4. After leaving water, test the brakes. Apply them lightly several times while driving slowly. The friction will help dry out the pads.

If it's unavoidable to enter water deeper than the footrest level:

- Proceed slowly. Avoid rocks and obstacles.
- Balance your weight carefully. Avoid sudden movements.
- Maintain a steady rate of speed. Do not make sudden turns or stops. Do not make sudden throttle changes.

OPERATION

Driving Over Obstacles

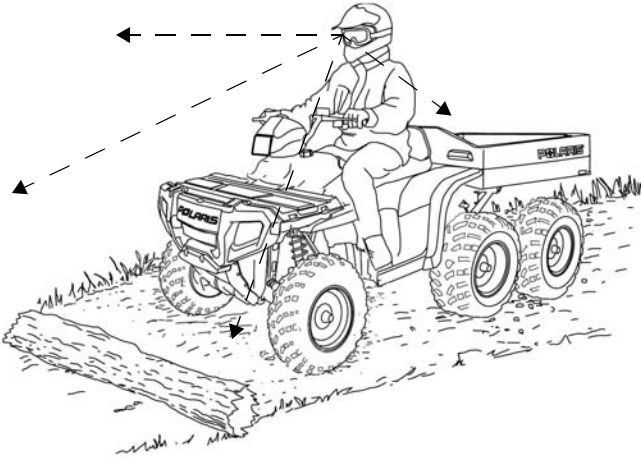

Follow these precautions when operating over obstacles:

1. Always check for obstacles before operating in a new area.
2. Look ahead and learn to read the terrain. Be constantly alert for hazards such as logs, rocks and low hanging branches.
3. Travel slowly and use extra caution when operating on unfamiliar terrain. Not all obstacles are immediately visible.
4. Never attempt to operate over large obstacles, such as rocks or fallen trees.

Driving in Reverse

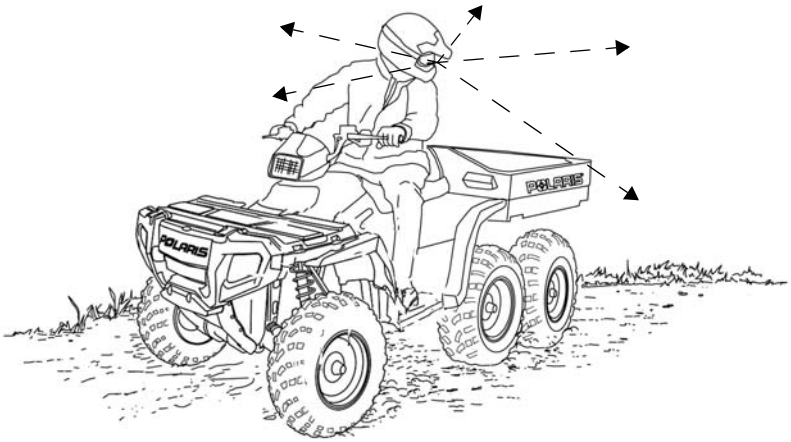

Follow these precautions when operating in reverse:

1. Always check for obstacles or people behind the vehicle.
2. Always avoid backing downhill.
3. Back slowly.
4. Apply the brakes *lightly* for stopping.
5. Avoid turning at sharp angles.
6. Never open the throttle suddenly.
7. Do not use the override button unless additional wheel speed is required for vehicle movement. Use the override with caution as rearward vehicle speed is greatly increased. Do not operate at wide open throttle. Operate the throttle just enough to maintain a desired speed.

NOTICE: Excessive throttle operation while in the speed limit mode may cause fuel to build in the exhaust, resulting in engine popping and/or engine damage.

OPERATION

Hauling Cargo

⚠ WARNING

Overloading the vehicle or carrying or towing cargo improperly can alter vehicle handling and may cause loss of control or brake instability, which can result in serious injury or death. Always follow these precautions when hauling cargo:

- Never exceed the maximum weight capacity of the vehicle. When determining the weight you are adding to the vehicle, include the weight of the operator, accessories, loads in the rack or box and the load on the trailer tongue. The combined weight of these items must not exceed the maximum weight capacity.
- Reduce speed and allow a greater distance for braking.
- Cargo should be properly distributed and carried as low and forward in the cargo box as possible.
- Always attach the tow load to the hitch point designated for your vehicle.
- Use extreme caution when applying brakes with a loaded vehicle. Avoid terrain or situations that may require backing downhill.
- Do not block the front headlight beam when carrying loads on the front rack.
- Do not tow any trailer on a grade steeper than 15°.
- Vehicle should never exceed 10 mph (16 km/h) while towing a load on a level surface. Vehicle speed should never exceed 5 mph (8 km/h) when towing loads in rough terrain, while cornering, or while ascending or descending a hill.

Maximum Cargo Capacities (Level Ground)	
Total Cargo	900 lbs. (408 kg)
Front Rack Cargo	100 lbs. (45 kg)
Cargo Box	800 lbs. (363 kg)

Maximum Towing Capacities	
Towed Load (level ground)	1500 lbs. (681 kg)
Towed Load (up to 15° incline)	850 lbs. (386 kg)
Vertical Hitch Weight	150 lbs. (68 kg)
Towing Grade	15°

Hauling Cargo

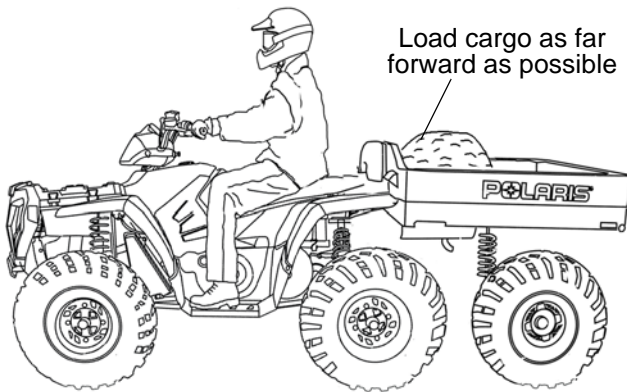

1. Always read and understand the load distribution warning labels on the vehicle, and never exceed the weight capacities outlined in the specifications section of the owner's manual and on the safety labels. The total load (operator, accessories, cargo and weight on hitch) must not exceed the maximum weight capacity of the vehicle.
2. Always load the cargo box with the load as far forward as possible.
3. Always operate the vehicle with extreme caution whenever hauling or towing loads. Balance, handling and control may be affected.
4. Slow down.
5. The cargo box dump latch must be securely latched before loading and operating. Unintentional box tilting will result if weight is placed in the rear of the box and the latch is not secured.
6. Always attach a towed load to the hitch point.

NOTICE: Using an improper hitch or exceeding the maximum tongue weight capacity can result in serious damage to the vehicle and will void your vehicle warranty. Never install a hitch longer than 8.25" (21 cm). Never install automotive accessories on your Polaris vehicle. Always install Polaris-approved (or equivalent) accessories designed for use on this vehicle.

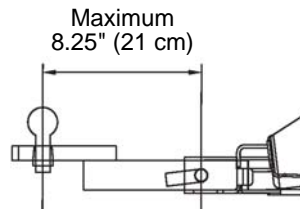

OPERATION

Hauling Cargo

Dumping Cargo

1. Select a level site to dump the cargo.
Do not attempt to dump or unload the vehicle while parked on an incline.
2. Lock the parking brake.
3. Dismount the vehicle.
4. Check cargo distribution. If cargo has shifted to the rear of the box, exercise caution.

WARNING! If the weight distribution in the box is located toward the rear of the box when the release lever is pulled forward, the box may dump on its own, which could cause serious injury. Never operate the dump lever without checking the position of the load. This will prevent unexpected dumping of the cargo box. Never carry passengers in the cargo box.

5. Pull the cargo box release lever forward.
6. Lift the front of the cargo box to dump the cargo.
7. Lower the cargo box. Make sure the latch is secure before operating.

WARNING! Operating with the cargo box in the raised position can cause serious injury and damage to the vehicle. The cargo box could close unexpectedly and injure the driver. The rear tires will also catch the rear of the box, damaging the vehicle and creating hazardous driving conditions. Never operate this vehicle with the cargo box in the raised position.

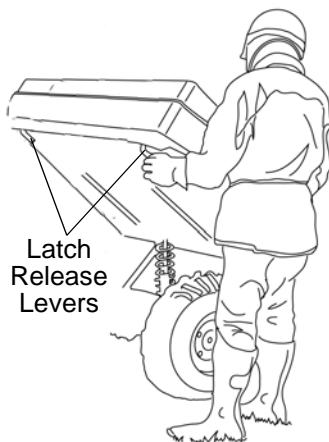

Parking on an Incline

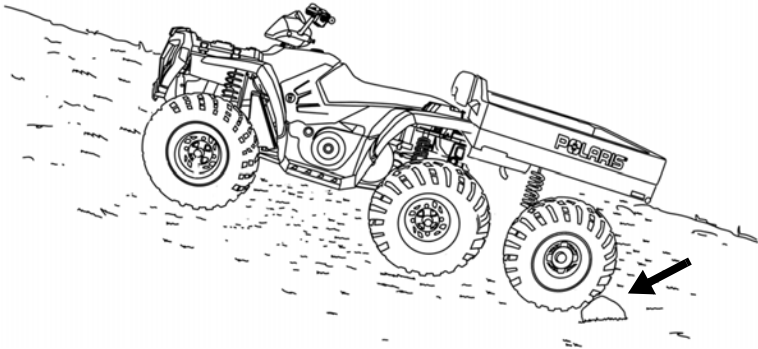

Avoid parking on an incline if possible. If it's unavoidable, follow these precautions:

1. Stop the engine.
2. Place the transmission in park.
3. Lock the parking brake.
4. Always block the rear wheels on the downhill side.

EMISSION CONTROL SYSTEMS

Noise Emission Control System

Do not modify the engine, intake or exhaust components, as doing so may affect compliance with U.S.A. EPA noise control requirements (40 CFR 205) and local noise level requirements.

Operation on Public Lands in the U.S.A.

Your Polaris vehicle has a spark arrestor that was tested and qualified to be in accordance with the USDA Forest Service Standard 5100-1C. Federal law requires that this spark arrestor be installed and functional when the vehicle is operated on public lands.

Operation of off-road vehicles on public lands in the U.S.A. is regulated by 43 CFR 8343.1(c). Violations are subject to monetary penalties. Federal regulations can be viewed online at www.gpoaccess.gov/ecfr/.

Crankcase Emission Control System

This engine is equipped with a closed crankcase system. Blow-by gases are forced back to the combustion chamber by the intake system. All exhaust gases exit through the exhaust system.

Exhaust Emission Control System

Exhaust emissions are controlled by engine design. An electronic fuel injection (EFI) system controls fuel delivery. The engine and EFI components are set at the factory for optimal performance and are not adjustable.

The vehicle compliance labels can be found on the frame tubing of the vehicle.

Electromagnetic Interference

This spark ignition system complies with Canadian ICES-002.

This vehicle complies with European directives 97/24/EC and 2004/108/EC.

Periodic Maintenance Chart

Careful periodic maintenance will help keep your vehicle in the safest, most reliable condition. Inspection, adjustment and lubrication of important components are explained in the periodic maintenance chart.

Inspect, clean, lubricate, adjust and replace parts as necessary. When inspection reveals the need for replacement parts, use genuine Polaris parts available from your Polaris dealer.

Record maintenance and service in the Maintenance Log beginning on page 131.

Service and adjustments are important for proper vehicle operation. If you're not familiar with safe service and adjustment procedures, have a qualified dealer perform these operations.

Maintenance intervals in the following chart are based upon average riding conditions and an average vehicle speed of approximately 10 miles per hour. Vehicles subjected to severe use must be inspected and serviced more frequently.

Severe Use Definition

- Frequent immersion in mud, water or sand
- Racing or race-style high RPM use
- Prolonged low speed, heavy load operation
- Extended idle
- Short trip cold weather operation

Pay special attention to the oil level. A rise in oil level during cold weather can indicate contaminants collecting in the oil sump or crankcase. Change oil immediately if the oil level begins to rise. Monitor the oil level, and if it continues to rise, discontinue use and determine the cause or see your dealer.

MAINTENANCE

Periodic Maintenance Chart

⚠ WARNING

Improperly performing the procedures marked with a ■ could result in component failure and cause an accident, which may result in serious injury or death. Always have an authorized Polaris dealer perform these services.

Maintenance Chart Key

- ▶ Perform these operations more often for vehicles subjected to severe use.
- E Emission-related service (Failure to conduct this maintenance will not void the emissions warranty but may affect emissions.)
- Have an authorized Polaris dealer perform these services.

Perform all services at whichever maintenance interval is reached first.

Item	Maintenance Interval (whichever comes first)			Remarks
	Hours	Calendar	Miles (Km)	
■ Steering	-	Pre-Ride	-	Make adjustments as needed. See Pre-Ride Checklist on page 48.
▶ Front suspension	-	Pre-Ride	-	
▶ Rear suspension	-	Pre-Ride	-	
Tires	-	Pre-Ride	-	
▶ Brake fluid level	-	Pre-Ride	-	
▶ Brake lever travel	-	Pre-Ride	-	
Brake system	-	Pre-Ride	-	
Wheels/fasteners	-	Pre-Ride	-	
Frame fasteners	-	Pre-Ride	-	
▶ Engine oil level	-	Pre-Ride	-	
▶ E Air filter, pre-filter	-	Daily	-	Inspect; clean often; replace as needed
▶ Air box sediment tube	-	Daily	-	Drain deposits when visible
Coolant (if applicable)	-	Daily	-	Check level daily, change coolant every 2 years
▶ ADC fluid (ADC models)	-	Daily	-	Check level daily, add as needed
Headlamp/taillight	-	Daily	-	Check operation; apply dielectric grease if replacing

MAINTENANCE

Periodic Maintenance Chart

	Item	Maintenance Interval (whichever comes first)			Remarks
		Hours	Calendar	Miles (Km)	
▶ E	Air filter, main element	-	Weekly	-	Inspect; replace as needed
▶ ■	Brake pad wear	10 H	Monthly	60 (100)	Inspect periodically
▶	Engine oil change (break-in)	20 H	1 M	125 (200)	Perform a break-in oil change
	Battery	20 H	Monthly	125 (200)	Check terminals; clean; test
▶	Front gearcase (demand drive) oil	25 H	Monthly	155 (250)	Inspect level; change yearly
▶	Middle gearcase oil (if equipped)	25 H	Monthly	155 (250)	Inspect level; change yearly
▶	Rear gearcase oil (if equipped)	25 H	Monthly	155 (250)	Inspect level; change yearly
▶	Transmission oil	25 H	Monthly	155 (250)	Inspect level; change yearly
▶ E	Engine breather filter (if equipped)	25 H	Monthly	155 (250)	Inspect; clean if needed
▶	General lubrication	50 H	3 M	310 (500)	Lubricate all fittings, pivots, cables, etc.
	Shift linkage	50 H	6 M	310 (500)	Inspect, lubricate, adjust
■	Steering	50 H	6 M	310 (500)	Lubricate
▶	Front suspension	50 H	6 M	310 (500)	Lubricate
▶	Rear suspension	50 H	6 M	310 (500)	Lubricate
■ E	Throttle Cable/ ETC Switch	50 H	6 M	310 (500)	Inspect; adjust; lubricate; replace if necessary
E	Throttle Body Intake Duct	50 H	6 M	310 (500)	Inspect duct for proper seal- ing/air leaks
▶	Front hub bear- ings (if equipped)	50 H	6 M	310 (500)	Inspect; clean; replace as needed
	Drive belt	50 H	6 M	310 (500)	Inspect; adjust; replace as needed
	Cooling system (if applicable)	50 H	6 M	620 (1000)	Inspect coolant strength seasonally; pressure test system yearly

MAINTENANCE

Periodic Maintenance Chart

Item		Maintenance Interval (whichever comes first)			Remarks
		Hours	Calendar	Miles (Km)	
▶	Engine oil change	100 H	6 M	620 (1000)	Perform a break-in oil change at one month
▶	Oil filter change	100 H	6 M	620 (1000)	Replace with oil change
■ E	Valve clearance	100 H	12 M	620 (1000)	Inspect; adjust
	Fuel system	100 H	12 M	620 (1000)	Check for leaks at tank cap, lines, filter, pump; replace lines every two years
▶	Radiator (if applicable)	100 H	12 M	620 (1000)	Inspect; clean external surfaces
▶	Cooling hoses (if applicable)	100 H	12 M	620 (1000)	Inspect for leaks
▶	Engine mounts	100 H	12 M	620 (1000)	Inspect
	Exhaust muffler/pipe	100 H	12 M	620 (1000)	Inspect
■ E	Spark plug	100 H	12 M	620 (1000)	Inspect; replace as needed
▶	Wiring	100 H	12 M	620 (1000)	Inspect for wear, routing, security; apply dielectric grease to connectors subjected to water, mud, etc.
■	Clutches (drive and driven)	100 H	12 M	620 (1000)	Inspect; clean; replace worn parts
■	Shift selector lubricant	200 H	24 M	1240 (2000)	Inspect; replace as needed
■	Brake fluid	200 H	24 M	1240 (2000)	Change every two years
■	ADC fluid (ADC models)	200 H	24 M	1240 (2000)	Change every two years
▶ ■ E	Fuel filter	200 H	24 M	1240 (2000)	Check for leaks around lines. Replace every 2 years, more often under extreme conditions.
	Spark arrestor	300 H	36 M	1860 (3000)	Clean out
■	Toe adjustment	-			Inspect periodically; adjust when parts are replaced
▶ ■	Auxiliary brake	-			Inspect daily; adjust as needed
	Headlight aim	-			Adjust as needed

▶ Perform these procedures more often for vehicles subjected to severe use.

E Emission-Related Service

■ Have an authorized Polaris dealer perform these services.

MAINTENANCE

Lubrication Recommendations

Check and lubricate all components at the intervals outlined in the Periodic Maintenance Chart beginning on page 67. Items not listed in the chart should be lubricated at the General Lubrication interval.

The a-arms and lower control arms are lubricated at the factory, and no additional lubrication will be needed. However, if these components are subjected to severe use, grease zerks have been provided for additional lubrication at the user's discretion.

Item	Lube	Method
Engine Oil	PS-4 PLUS Performance Synthetic 2W-50	See page 72.
Brake Fluid	DOT 4 Only	See page 31.
Drive Chains	O-ring chain lube or SAE 80/90	Lubricate as often as required (before each ride in wet conditions).
Gear Selector Oil	PS-4 PLUS Performance Synthetic 2W-50	Maintain oil level at the center of the shift rail. Do not overfill.
Transmission Oil	Polaris Premium Synthetic Gearcase Lube	See page 75.
Front Gearcase (Demand Drive) Oil	Demand Drive LT Premium Fluid	See page 76.
Middle Gearcase Oil	Premium ATV Angle Drive Fluid (or GL5 80-90 weight gear lube)	See page 79.
Rear Gearcase Oil		See page 78.
ADC Fluid	Polaris ADC Fluid	See page 80.
Front Prop Shaft Yoke	Polaris Premium U-Joint Lube	Grease fittings (3 pumps maximum) every 500 miles, before long periods of storage, or after pressure washing or submerging

► = Perform more often for vehicles subjected to severe use

Front Prop Shaft Yoke

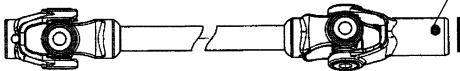

MAINTENANCE

Engine Oil

Oil Recommendations

Polaris recommends the use of Polaris PS-4 *PLUS Performance Synthetic* 2W-50 4-cycle oil or a similar oil for this engine. Oil may need to be changed more frequently if Polaris oil is not used. Always use 2W-50 oil. Follow the manufacturer's recommendations for ambient temperature operation. See page 124 for the part numbers of Polaris products.

NOTICE: Mixing brands or using a non-recommended oil may cause serious engine damage. Always use the recommended oil. Never substitute or mix oil brands.

Oil Level

Access the oil dipstick and fill tube from the left side of the vehicle.

1. Position the vehicle on a level surface.
2. Lift the lever lock to remove the dipstick. Wipe it dry with a clean cloth.
3. Reinstall the dipstick completely, but do not lock it. The dipstick must be inserted completely to keep the angle and depth of the stick consistent.
4. Remove the dipstick and check the oil level. Maintain the oil level in the safe range. Do not overfill.

Tip: Due to the dipstick entry angle into the crankcase, the oil level will read higher on the bottom side of the dipstick. Always read the level on the upper surface of the dipstick.

5. After reinstalling the dipstick, seat the lever lock.

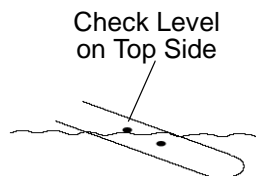
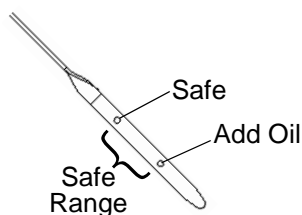
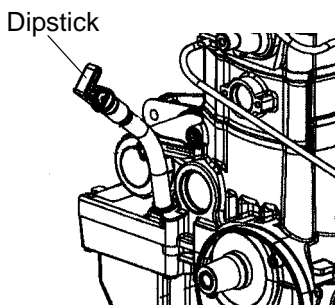

Engine Oil Oil and Filter Change

Always change the oil and filter at the intervals outlined in the Periodic Maintenance Chart beginning on page 67. Always change the oil filter whenever changing oil.

1. Position the vehicle on a level surface.
2. Start the engine.
Allow it to warm up at idle for two to three minutes. Stop the engine.
3. Clean the area around the drain plug.
4. Place a drain pan under the crankcase.
5. Remove the drain plug. Allow the oil to drain completely.

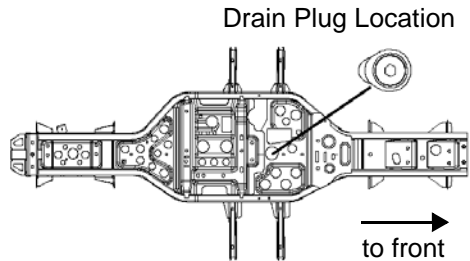

- CAUTION!** Hot oil can cause burns to skin. Do not allow hot oil to contact skin.
6. Install a new sealing washer on the drain plug. The sealing surfaces on drain plug and crankcase should be clean and free of burrs, nicks or scratches.
 7. Reinstall the drain plug. Torque to 20 ft. lbs. (27 Nm).
 8. Place shop towels beneath the oil filter. Using an oil filter wrench (available from your Polaris dealer), turn the filter counter-clockwise to remove it.
 9. Using a clean dry cloth, clean the filter sealing surface on the crankcase.

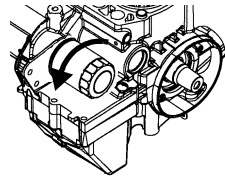

MAINTENANCE

Engine Oil

Oil and Filter Change

10. Lubricate the o-ring on the new filter with a film of fresh engine oil. Check to make sure the o-ring is in good condition.
11. Install the new filter and rotate it clockwise by hand until the filter gasket contacts the sealing surface, then turn it an additional 1/2 turn.
12. Remove the dipstick.
13. Add two quarts (1.9 l) of recommended oil.
14. Place the transmission in park.
15. Lock the parking brake.
16. Start the engine. Allow it to idle for one to two minutes.
17. Stop the engine.
18. Check for leaks.
19. Check the oil level. Add oil as needed to bring the level to the upper mark on the dipstick.
20. Dispose of used filter and oil properly.

Transmission Oil

Always check and change the transmission oil at the intervals outlined in the Periodic Maintenance Chart beginning on page 67. Maintain the oil level at the bottom of the fill plug hole. The fill plug is located on the right side of the ATV behind the footwell. The drain plug is located on the bottom left side of the gearcase.

We recommend the use of Polaris Premium AGL Synthetic Gearcase Lubricant. See page 124 for the part numbers of Polaris products.

Access the transmission fill plug from the right side of the vehicle. Access the drain plug from the left side of the vehicle.

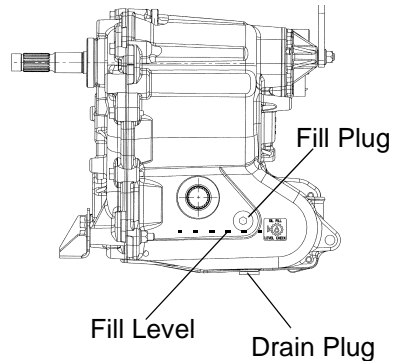

Oil Check

1. Position the vehicle on a level surface.
2. Remove the footwell (see page 86).
3. Remove the fill plug. Check the oil level.
4. Reinstall the fill plug. Torque to 14 ft. lbs. (19 Nm).
5. Reinstall the footwell.

Oil Change

1. Remove the footwell (see page 86).
2. Place a drain pan under the gearcase. Remove the drain plug. Allow the oil to drain completely.
3. Clean and reinstall the drain plug. Torque to 14 ft. lbs. (19 Nm).
4. Remove the fill plug. Add 15 oz. (450 ml) of the recommended oil.
5. Reinstall the fill plug. Torque to 14 ft. lbs. (19 Nm).
6. Check for leaks.
7. Reinstall the footwell.
8. Dispose of used oil properly.

MAINTENANCE

Front Gearcase (Demand Drive) Fluid

Always check and change the demand drive fluid at the intervals outlined in the Periodic Maintenance Chart beginning on page 67. We recommend the use of Demand Drive LT Premium Fluid. Use of other fluids may result in improper operation of components. See page 124 for the part numbers of Polaris products.

Maintain the fluid level at the bottom of the fill hole threads. See below for capacity.

Demand Drive Capacities	
Demand Drive with ADC	9.3 oz. (275 ml)

The fill plug is located on the right side of the demand drive unit. The drain plug is located on the bottom right side of the unit.

Fluid Check

1. Position the vehicle on a level surface. Remove the fill plug. Check the fluid level.
2. Add the recommended fluid as needed to bring the level to the bottom of the fill hole threads.
3. Reinstall the fill plug. Torque to 8-10 ft. lbs. (11-14 Nm).

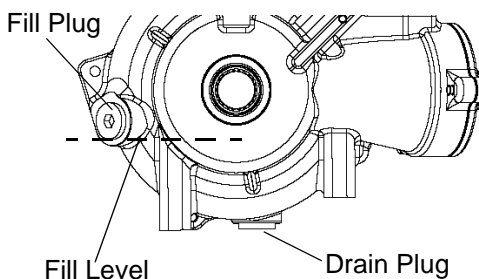

Front Gearcase (Demand Drive) Fluid Fluid Change

1. Position the vehicle on a level surface. Remove the fill plug.
2. Place a drain pan under the demand drive unit.
3. Remove the drain plug. Allow the fluid to drain completely.
4. Clean and reinstall the drain plug. Torque to 11 ft. lbs. (15 Nm).
5. Add the recommended fluid.
6. Reinstall the fill plug. Torque to 8-10 ft. lbs. (11-14 Nm).
7. Check for leaks.
8. Dispose of used fluid properly.

MAINTENANCE

Rear Gearcase Oil

Always check and change the rear gearcase oil at the intervals outlined in the Periodic Maintenance Chart beginning on page 67. Maintain the fluid level at the bottom of the fill hole threads. The oil capacity is 5 oz. (150 ml). Do not overfill.

The fill plug is located on the rear of the gearcase. The drain plug is located on the bottom of the gearcase.

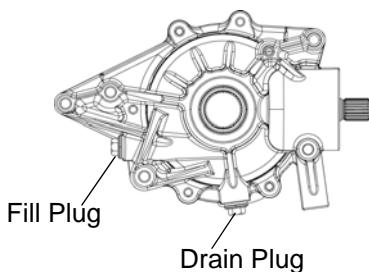

We recommend the use of Polaris ATV Angle Drive Fluid (or GL5 80-90 weight gear lube). See page 124 for the part numbers of Polaris products.

Oil Check

1. Position the vehicle on a level surface.
2. Remove the fill plug. Check the oil level.
3. Add the recommended oil as needed to bring the level to the bottom of the fill hole threads. *Do not overfill.*
4. Reinstall the fill plug. Torque to 14 ft. lbs. (19 Nm).

Oil Change

1. Position the vehicle on a level surface.
2. Place a drain pan under the drain hole.
3. Remove the drain plug. Allow the oil to drain completely.
4. Clean and reinstall the drain plug with a new sealing washer. Torque to 14 ft. lbs. (19 Nm).
5. Remove the fill plug. Add 5 oz. (150 ml) of the recommended oil. *Do not overfill.*
6. Reinstall the fill plug. Torque to 14 ft. lbs. (19 Nm).
7. Check for leaks.
8. Dispose of used oil properly.

Middle Gearcase Oil

Always check and change the middle gearcase oil at the intervals outlined in the Periodic Maintenance Chart beginning on page 67.

We recommend the use of Polaris ATV Angle Drive Fluid (or GL5 80-90 weight gear lube). See page 124 for the part numbers of Polaris products.

The middle gearcase fill plug is located on the side of the gearcase. Maintain the oil level even with the bottom thread of the fill plug hole.

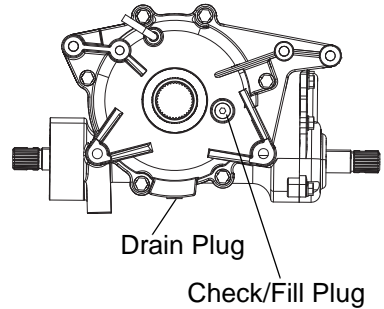

Oil Check

1. Position the vehicle on a level surface.
2. Remove the fill plug. Check the oil level.
3. Add the recommended oil as needed.
4. Reinstall the fill plug. Torque to 14 ft. lbs. (19 Nm).

Oil Change

1. Remove the fill plug.
2. Remove the drain plug from the bottom of the gearcase. Drain the oil into a drain pan. Discard used oil properly.
3. Clean and reinstall the drain plug. Torque to 14 ft. lbs. (19 Nm).
4. Add 17 oz. (500 ml) the recommended fluid.
5. Reinstall the fill plug. Torque to 14 ft. lbs. (19 Nm).
6. Check for leaks

MAINTENANCE

Active Descent Control (ADC) Fluid

If your vehicle is equipped with Active Descent Control, there are two fluid levels that must be maintained (demand drive fluid and ADC fluid). See page 76 for demand drive fluid maintenance. Check and change the ADC fluid level at the intervals outlined in the Periodic Maintenance Chart beginning on page 67. Maintain the fluid level between the minimum and maximum marks on the reservoir. We recommend the use of Polaris ADC Fluid. See page 124 for the part numbers of Polaris products.

NOTICE: Do not use brake fluid. Brake fluid will damage rubber components in the hydraulic system.

1. Open the front box cover and pull open the access door.
2. View the fluid level in the reservoir.
3. If the level is below the minimum mark, remove the cap and add the recommended fluid.
4. Reinstall the cap. Secure the access door. Secure the box cover.

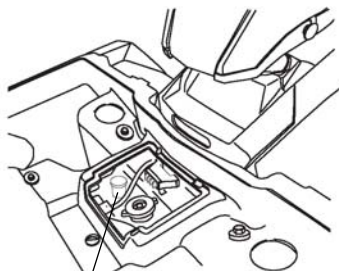

ADC Fluid Reservoir

Active Descent Control (ADC) Fluid Fluid Change

1. Position the vehicle on a level surface. Before performing the fluid change, allow the vehicle to sit for at least 30 minutes.
2. Thoroughly clean the areas around and on the ADC reservoir and bleeder valves (one on each side of the differential).
3. Remove the reservoir cap and diaphragm assembly. Use a shop towel or suction tool to remove debris from the fluid and reservoir. Debris in the reservoir may result in inadequate bleeding and reduced performance of the system.
4. Fill the reservoir to the maximum line with fresh ADC fluid.
5. Remove the protective caps from the bleeder valves.
6. Slowly loosen one of the valves (turn counter-clockwise) and allow fluid and trapped air to flow from the fitting. Close the valve when clean fluid begins to flow. Repeat this step for the remaining valve.

IMPORTANT: Close the bleeder valves before the reservoir fluid level drops below the minimum fill line. Adding fluid to an empty reservoir will result in trapped air. If the level drops below the minimum line, add fluid to the maximum line and repeat step 6 before proceeding.

7. Torque the valves to 80 in. lbs. (9 Nm). Reinstall the valve caps.
8. Add fresh ADC fluid to the reservoir until the level is between the minimum and maximum marks. Make sure the reservoir is free of debris.
9. Reinstall the cap securely.
10. Clean up any drips or spills.

MAINTENANCE

Cooling System

The engine coolant level is controlled, or maintained, by the recovery system. The recovery system components are the recovery bottle, the radiator filler neck, the radiator pressure cap and the connecting hose.

As coolant operating temperature increases, the expanding (heated) excess coolant is forced out of the engine, past the pressure cap, and into the recovery bottle. As engine coolant temperature decreases the contracting (cooled) coolant is drawn back up from the bottle, past the pressure cap, and into the radiator.

Some coolant level drop on new vehicles is normal as the system is purging itself of trapped air. Check the coolant level and maintain as recommended by adding coolant to the recovery bottle.

Polaris recommends the use of Polaris Premium 60/40 anti-freeze/coolant or a 50/50 mixture of high quality aluminum compatible anti-freeze/coolant and distilled water. Polaris Premium 60/40 is already premixed and ready to use. Do not dilute with water. See page 124 for the part numbers of Polaris products.

Always follow the manufacturer's mixing recommendations for the freeze protection required in your area.

Recovery Bottle Coolant

The recovery bottle is located on the left side of the vehicle.

1. Remove the left side panel.
See page 86.
2. Maintain the coolant level between the minimum and maximum marks on the bottle (when the fluid is cool).
3. Add coolant as needed.

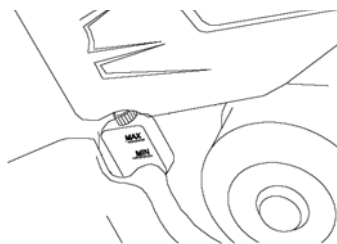

Cooling System Radiator Coolant

To ensure that the coolant maintains its ability to protect the engine, Polaris recommends that you drain the system completely every two years and add a fresh mixture of antifreeze and water.

Replace the coolant any time the cooling system has been drained for maintenance or repair. If the recovery bottle has run dry, check the level in the radiator. Add coolant as needed.

CAUTION! Escaping steam can cause burns. Never remove the pressure cap while the engine is warm or hot. Always allow the engine to cool before removing the pressure cap.

1. Open the front box cover and pull open the access door.
2. Remove the pressure cap.
3. Using a funnel, slowly add coolant through the radiator filler neck.
4. Reinstall the pressure cap. Use of a non-standard pressure cap will not allow the recovery system to function properly. Contact your dealer for the correct replacement part.
5. Secure the access door.
6. Secure the box cover.

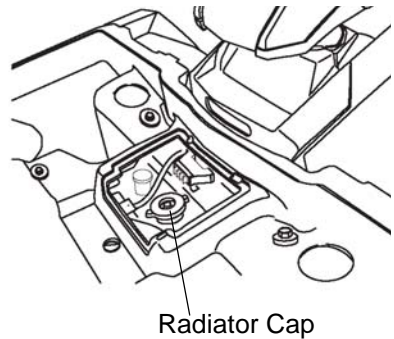

MAINTENANCE

Brakes

Front/Rear/Middle Brakes

The front, rear and middle brakes are hydraulic disc brakes. These brakes are self-adjusting.

Under normal operation, the diaphragm extends into the reservoir as fluid level drops. If the fluid level is low and the diaphragm is not extended, a leak is likely and the diaphragm should be replaced. To ensure proper diaphragm operation, always fill the reservoir as needed whenever the cover is loosened or removed. Do not overfill.

WARNING! An over-full master cylinder may cause brake drag or brake lock-up, which could result in serious injury or death. Maintain brake fluid at the recommended level. Do not overfill.

The following checks are recommended to keep the brake system in good operating condition. Check more often if brakes are used heavily under normal operation.

1. Always keep brake fluid at an adequate level. See page 31.
2. Check the brake system for fluid leaks.
3. Check the brakes for excessive travel or spongy feel.
4. Check the friction pads for wear, damage and looseness. Replace brake pads when they are worn to $3/64"$ (1 mm).
5. Check the security and surface condition of the disc.

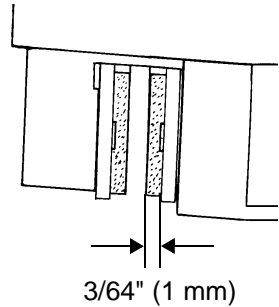

Toe Alignment

Use the following procedure to check the toe alignment of the vehicle. The recommended toe alignment is 1/8" to 1/4" (3-6 mm) toe out.

WARNING! Severe injury or death can result from improper toe alignment and adjustment. Do not attempt to adjust tie rod alignment. All tie rod adjustments should be performed by an authorized Polaris dealer.

1. Position the vehicle on a level surface.
2. Place the handlebars in a straight-ahead position.
3. Tie a length of string between two stands as shown in the illustration. Position the stands so that the string is flush with the side of the rear tire. If available, you may use a long straight-edge instead of string.
4. Measure the distance from the string to the rim at the front (1) and rear (2) of the front rim. The rear measurement should be 1/16"-1/8" (2-3 mm) more than the front measurement on each side of the vehicle to obtain the recommended 1/8" to 1/4" (3-6 mm) toe out alignment.

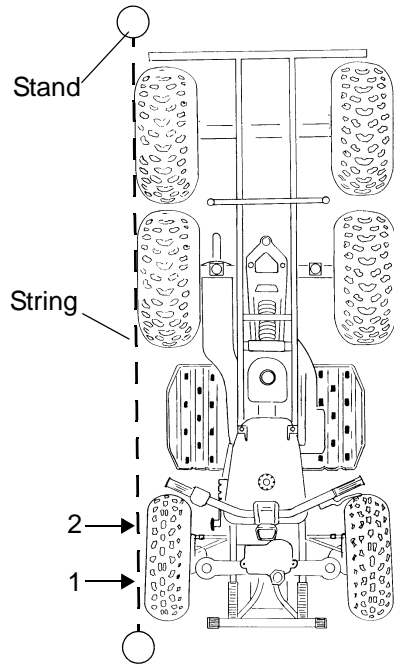

5. Repeat the measurement procedure on the other side of the vehicle.
6. If you discover improper alignment, see your Polaris dealer for service.

MAINTENANCE

Steering Assembly

The steering assembly of the vehicle should be checked periodically for loose nuts and bolts. If loose nuts and bolts are found, see your Polaris dealer for service before operating the vehicle.

Side Panel Removal

1. Remove the seat.
2. Grasp the rear of the side panel near the rear cab. With a firm motion, pull the panel outward to disengage the side panel from the grommet. Pull the panel downward and rearward to remove it.
3. When reinstalling side panels, align the fasteners and press firmly to secure them.

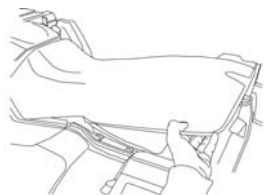

Step 1

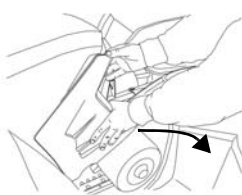

Step 2

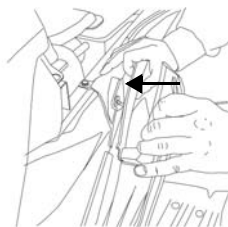

Step 3

Footwell Removal

1. Remove the four screws on the bottom of the footwell.
2. Use a flat screwdriver or sidecutters to remove the plastic rivets securing the footwell to the fenders.
3. Remove the footwell.

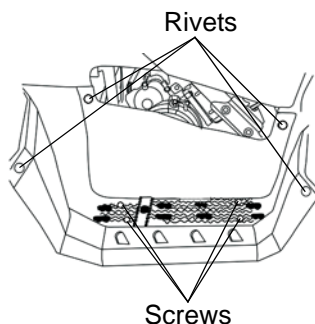

Tires

⚠ WARNING

Operating your vehicle with worn tires, improperly inflated tires, non-standard tires or improperly installed tires will affect vehicle handling and could cause an accident resulting in serious injury or death. Always follow all tire maintenance procedures as outlined in this manual and on the labels on the vehicle. Always use original equipment size and type when replacing tires.

Refer to the specifications section beginning on page 122 for recommended tire type, size and pressure.

Tire Tread Depth

Always replace tires when tread depth is worn to 1/8" (3 mm) or less.

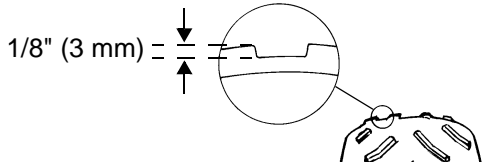

Front Wheel Hub Tightening

Front wheel bearing tightness and spindle nut retention are critical component operations. All service must be performed by your authorized Polaris dealer.

Wheel Removal

1. Stop the engine.
2. Place the transmission in park.
3. Lock the parking brake.
4. Loosen the wheel nuts slightly.

WARNING! Do not service axle nuts that have a cotter pin installed. See your Polaris dealer.

5. Elevate the side of the vehicle by placing a suitable stand under the footrest frame.
6. Remove the wheel nuts.
7. Remove the wheel.

MAINTENANCE

Tires

Wheel Installation

1. Place the transmission in park.
2. Lock the parking brake.
3. Place the wheel on the hub with the valve stem toward the outside and rotation arrows on the tire pointing toward forward rotation.
4. Install the wheel nuts and finger-tighten them.
5. Lower the vehicle to the ground.
6. Torque the wheel nuts to specification.

WARNING! Loose nuts could cause a tire to come off during operation, which could result in an accident or overturn. Always ensure that all nuts are torqued to specification.



90 ft. lbs.
(122 Nm)

Cast Aluminum



27 ft. lbs.
(37 Nm)

Steel

Wheel Nut Torque Specifications

Check the wheel nut torques occasionally and when they've been loosened for maintenance service.

Nut Type	Nut Torque
Lug Nut	90 ft. lbs. (122 Nm)
2-Piece Flange Nut	27 ft. lbs. (37 Nm)

Air Filter

1. Remove the seat.
2. Release the air box cover clips, and remove the air box cover.
3. Loosen the clamp and remove the filter.
4. Remove the fabric type pre-filter from the main filter. Wash the pre-filter in soapy water, then rinse and let dry.
5. Reinstall the pre-filter over the main filter. Install a new main filter if needed.
6. Reinstall the filter into the air box and tighten the clamp. Do not over-tighten the clamp, as filter damage could occur.
7. Reinstall the air box cover and the seat.

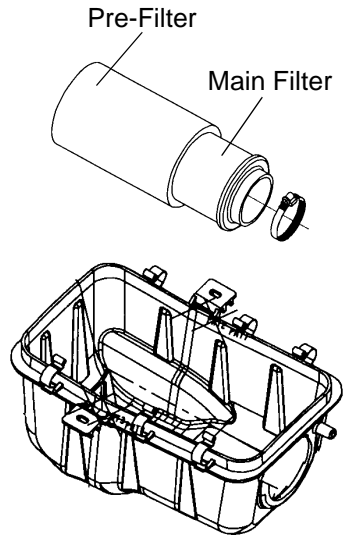

MAINTENANCE

Fuse Replacement

Fuse	Feature Supported
5A	Speedometer
15A	Electronic Fuel Injection
20A	(Main Fuse) Ignition, Lighting
20A	Accessories, 12V Power Receptacle

If the engine stops or will not start, or if you experience other electrical failures, a fuse may need replacement. Locate and correct any short circuits that may have caused the blown fuse, then replace the fuse. Spare fuses are provided in a compartment on the top of the access door.

1. Open the front box cover and pull open the access door.
2. Remove the suspect fuse from the fuse panel. If the fuse is blown, install a new fuse with the same amperage.
3. Secure the access door.
4. Secure the box cover.

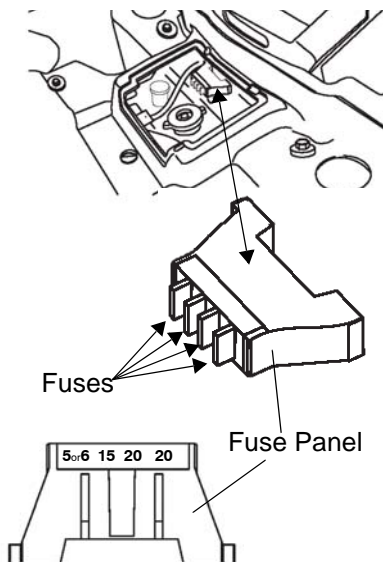

Lights

Poor lighting can result in reduced visibility when driving. Headlight and taillight lenses become dirty during normal operation. Clean lights frequently and replace burned out lamps promptly. Always make sure lights are adjusted properly for best visibility.

Upper Headlight Lamp Replacement

When servicing a halogen lamp, don't touch the lamp with bare fingers. Oil from your skin leaves a residue, causing a hot spot that will shorten the life of the lamp.

1. Remove the two screws on the lower front corners of the headlight pod.
2. Remove the screw from the rear of the pod.
3. Lift the pod slightly while depressing the tabs at the rear of the pod.
4. Lift the pod cover and disconnect the speedometer harnesses from the speedometer.

CAUTION! Hot components can cause burns to skin. Allow lamps to cool before servicing.

5. Unplug the headlamp from the wiring harness. Be sure to pull on the connector, not on the wiring.
6. Turn the lamp counterclockwise to remove it.
7. Apply dielectric grease to the socket and install the new lamp. Make sure the tab on the lamp locates properly in the housing.
8. Reassemble the pod.

MAINTENANCE

Lights

High Beam Adjustment

The headlight beam can be adjusted slightly upward or downward. Use the following procedure to make the adjustment.

1. Position the vehicle on a level surface with the headlight approximately 25 ft. (7.6 m) from a wall. Place the transmission in park.

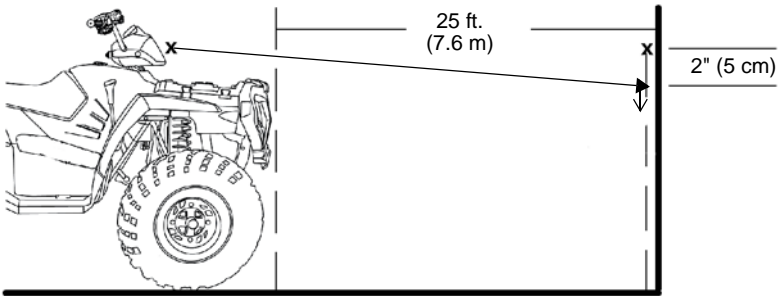

2. Measure the distance from the floor to the center of the headlight and make a mark on the wall at the same height.
3. Start the engine. Turn the headlight switch to high beam.
4. Observe the headlight aim on the wall. The most intense part of the headlight beam should be two inches (5 cm) below the mark on the wall. Include rider weight on the seat when measuring.
5. The adjustment knob is located on the right side of the headlight pod. Adjust the beam to the desired position by turning the knob either clockwise or counterclockwise.

Lights

Low Beam Adjustment

The low beam can be adjusted slightly upward or downward.

1. Loosen the phillips screw located at the rear of the headlamp.
2. Tilt the headlamp upward or downward.
3. Tighten the screw.

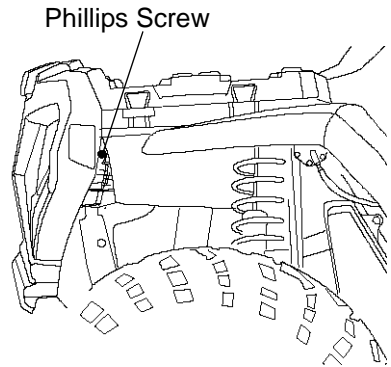

MAINTENANCE

Lights

Headlight Housing Replacement

1. Remove the two screws on the lower front corners of the headlight pod.
2. Lift the pod slightly while depressing the tabs at the rear of the pod.
3. Lift the pod cover and disconnect the speedometer harnesses from the speedometer.
4. Unplug the headlamp from the wiring harness.
5. Use a small screwdriver to remove the o-rings from the headlight mounting tabs.
6. Pull the headlight housing up to release it from the locking tabs.
7. Lift the adjusting knob up to remove it from the locking tabs.
8. Carefully pull the assembly up and out of the pod.
9. Reverse the steps to install the new housing and reassemble the pod. The distance from the headlamp parting line to the end of the adjustment knob stop is $5 \frac{1}{8}$ " (13 cm).
10. Adjust the headlight aim by turning the adjusting knob.

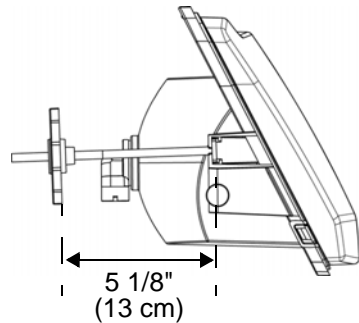

Lights

Lower Headlamp Replacement

1. Turn the back of the headlight harness counterclockwise and pull the harness assembly away from the headlight assembly.
2. Remove the headlamp and install the new headlamp.
3. Reinstall the harness assembly into the headlight assembly.
4. Turn the headlight harness clockwise to secure the headlamp.

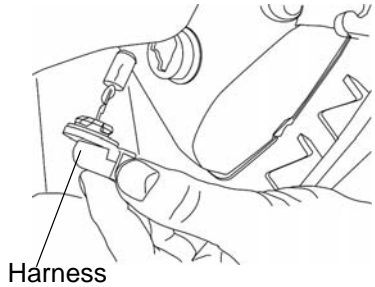

Taillight/Brakelight Lamp Replacement

1. Remove the taillight lens cover mounting screws. Remove the lens cover and gasket and set aside for reassembly.
2. Remove the lamp.
3. Apply dielectric grease to the socket and install the new lamp.
4. Test the light for proper operation.
5. Reinstall the gasket and lens cover.

MAINTENANCE

Spark Plugs

Spark Plug Recommendations

Refer to the specifications section beginning on page 122 for the recommended spark plug type and gap for your vehicle. Torque spark plugs to specification.

NOTICE: Using non-recommended spark plugs can result in serious engine damage. Always use Polaris-recommended spark plugs.

Plug Condition	Torque Specification
New Spark Plug	9-11 ft. lbs. (12-15 Nm)
Previously Installed Spark Plug	17-20 ft. lbs. (23-27 Nm)

Spark Plug Inspection

Spark plug condition is indicative of engine operation. Check the spark plug firing end condition after the engine has been warmed up and the vehicle has been driven at higher speeds. Immediately check the spark plugs for correct color. See page 97.

CAUTION! A hot exhaust system and engine can cause burns. Wear protective gloves when removing a spark plug for inspection.

1. Rotate the spark plug cap 1/4 turn and pull it off the spark plug.
2. Using the special wrench provided in the tool pouch, rotate the spark plug counterclockwise to remove it.
3. Reverse the procedure for spark plug installation. Torque to specification.

Spark Plugs

Spark Plug Inspection

Normal Spark Plug

The normal insulator tip is gray, tan or light brown. There will be few combustion deposits. The electrodes are not burned or eroded. This indicates the proper type and heat range for the engine and the service.

The tip should not be flaky and white. A white insulator tip indicates overheating, caused by use of an improper spark plug or incorrect fuel.

Wet Fouled Spark Plug

The wet fouled insulator tip is black. A damp oil film covers the firing end. There may be a carbon layer over the entire nose. Generally, the electrodes are not worn. General causes of fouling are excessive oil, use of non-recommended oil or incorrect throttle body adjustments.

MAINTENANCE

Vehicle Immersion

If your vehicle becomes immersed, major engine damage can result if the machine is not thoroughly inspected. Take the vehicle to your dealer before starting the engine. If it's impossible to take your vehicle to a dealer before starting it, follow the steps outlined below.

1. Move the vehicle to dry land or at the very least, to water below the footrests.
2. Check the air box. If water is present, dry the air box and replace the filter with a new filter.
3. Remove the spark plugs.
4. Turn the engine over several times using the electric start.
5. Dry the spark plugs. Reinstall the plugs or install new plugs.
6. Attempt to start the engine. If necessary, repeat the drying procedure.
7. Take the vehicle to your dealer for service as soon as possible, whether you succeed in starting it or not.
8. If water has been ingested into the PVT, follow the procedure on page 102 for drying out the PVT.

Spark Arrestor

⚠ WARNING

Failure to heed the following warnings while servicing the spark arrestor could result in serious injury or death. Never run the engine in an enclosed area. Remove any combustible materials from the area. Wear eye protection and leather work gloves. Do not stand behind or in front of the vehicle while purging. Never go under the vehicle while it's inclined.

The exhaust system can get extremely hot. Do not perform service on the spark arrestor while the system is hot. Allow components to cool sufficiently before proceeding.

Use the following procedure to periodically purge accumulated carbon from the exhaust pipe/muffler.

1. Remove the arrestor clean-out plug from the bottom of the muffler. Be sure to clean out both arrestors if your model has two.
2. Place the transmission in park.
3. Start the engine.
4. Quickly squeeze and release the throttle lever several times to purge carbon from the system.
5. If carbon comes out of the exhaust, cover or plug the exhaust outlet. Wear protective gloves.
6. Lightly tap on the exhaust pipe with a rubber mallet while repeating step 4.
7. If particles are still suspected to be in the muffler, elevate the rear of the vehicle one foot (30 cm) higher than the front. Block the wheels.
8. Place the transmission in park. Lock the parking brake. Repeat steps 4 to 6 until no more particles are expelled.
9. Stop the engine. Allow the arrestor to cool.
10. Reinstall the arrestor plug and remove the exhaust outlet cover or plug.

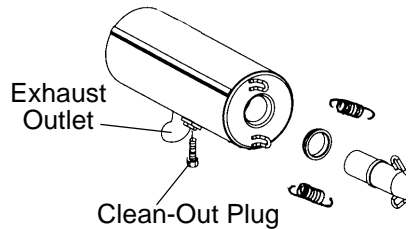

MAINTENANCE

PVT System

WARNING

Failure to comply with the instructions in this warning can result in severe injury or death.

Do not modify any component of the PVT system. Doing so may reduce its strength so that a failure may occur at a high speed. The PVT system has been precision balanced. Any modification will cause the system to be out of balance, creating vibration and additional loads on components.

The PVT system rotates at high speeds, creating large amounts of force on clutch components. Extensive engineering and testing has been conducted to ensure the safety of this product. However, as the owner, you have the following responsibilities to make sure this system remains safe:

- Always follow all recommended maintenance procedures. See your dealer as outlined in the owner's manual.
- This PVT system is intended for use on Polaris products only. Do not install it in any other product.
- Always make sure the PVT housing is securely in place during operation.

PVT System

The basic operation of the Polaris PVT system is dependent on engine speed and vehicle torque requirements. As engine speed increases, the force exerted on the movable drive sheave by the flyweights also increases. This, in turn, increases the amount of pinch applied to the drive belt. Similarly, if the engine speed decreases, the amount of centrifugal force decreases, reducing the amount of belt pinch.

The approximate gear ratio difference between high and low range is 1:2.25. This difference in gearing affects the operation of the PVT, especially at speeds less than 7 MPH (11 km/h), due to the system's dependence on engine speed.

For example, when operating at a ground speed of 3 MPH (5 km/h) in low range, the engine speed would be around 3000 RPM. This is well above the engagement speed of 1200 - 1400 RPM. However, in high range at 3 MPH (5 km/h), the engine would be running at only 1500 RPM. Whenever operating this close to the engagement speed, the engine may be running at a speed too low to provide the pinch needed to prevent belt slip. Belt slip is responsible for creating the excessive heat that destroys belts, wears clutch components and causes outer clutch covers to fail.

The air temperature in the clutch cover is substantially reduced by using low range while operating at low ground speeds. Reducing the temperature inside the clutch cover greatly extends the life of the PVT components (belt, cover, etc.).

MAINTENANCE

PVT System

When To Use Low Range and High Range

Condition	Range to Use
Operating at speeds less than 7 MPH (11 km/h)	Low
Towing heavy loads	Low
Operating in rough terrain (swamps, mountains, etc.)	Low
Operating at speeds greater than 7 MPH (11 km/h)	High

PVT Drying

There may be some instances when water is accidentally ingested into the PVT system. Use the following instructions to dry it out before operating.

1. Position the vehicle on a level surface.
2. Remove the drain plug. Allow the water to drain completely. Reinstall the drain plug.
3. Start the engine. Place the transmission in park.
4. Apply varying throttle for 10-15 seconds to expel the moisture and air-dry the belt and clutches. Do not hold the throttle wide open for more than 10 seconds.
5. Allow the engine RPM to settle to idle speed, then shift the transmission to the lowest available range.
6. Test for belt slippage. If the belt slips, repeat the process.
7. Take the vehicle to your dealer for service as soon as possible.

Battery

⚠ WARNING

Improperly connecting or disconnecting battery cables can result in an explosion and cause serious injury or death. When removing the battery, always disconnect the negative (black) cable first. When reinstalling the battery, always connect the negative (black) cable last.

⚠ WARNING

Battery electrolyte is poisonous. It contains sulfuric acid. Serious burns can result from contact with skin, eyes or clothing.

Antidote:

External: Flush with water.

Internal: Drink large quantities of water or milk. Follow with milk of magnesia, beaten egg, or vegetable oil. Call physician immediately.

Eyes: Flush with water for 15 minutes and get prompt medical attention.

Batteries produce explosive gases. Keep sparks, flame, cigarettes, etc. away. Ventilate when charging or using in an enclosed space. Always shield eyes when working near batteries. **KEEP OUT OF REACH OF CHILDREN.**

Your vehicle may have either a sealed battery, which requires little maintenance, or a conventional battery. A sealed battery can be identified by its flat covers on the top of the battery. A conventional battery has six filler caps on the top of the battery.

Always keep battery terminals and connections free of corrosion. If cleaning is necessary, remove corrosion with a stiff wire brush. Wash with a solution of one tablespoon baking soda and one cup water. Rinse well with tap water and dry off with clean shop towels. Coat the terminals with dielectric grease or petroleum jelly. Be careful not to allow cleaning solution or tap water into a conventional battery.

MAINTENANCE

Battery

Battery Removal

1. Remove the seat.
2. Disconnect the battery hold-down strap.
3. On conventional batteries, remove the battery vent tube.
4. Disconnect the black (negative) battery cable first.
5. Disconnect the red (positive) battery cable last.
6. Lift the battery out of the vehicle. Be careful not to tip a conventional battery sideways, which could spill electrolyte.

NOTICE: If electrolyte spills, immediately wash it off with a solution of one tablespoon baking soda and one cup water to prevent damage to the vehicle.

Battery

Battery Installation

Using a new battery that has not been fully charged can damage the battery and result in a shorter life. It can also hinder vehicle performance. Follow the battery charging instructions on page 107 before installing the battery.

1. Ensure that the battery is fully charged.
2. Place the battery in the battery holder.
3. With conventional batteries, install the battery vent tube (sealed batteries do not have a vent tube). The vent tube must be free of obstructions and securely installed. Route the tube away from the frame and vehicle body to prevent contact with electrolyte.

WARNING! Battery gases could accumulate in an improperly installed vent tube and cause an explosion, resulting in serious injury or death. Always ensure that the vent tube is free of obstructions and is securely installed as recommended.

4. On conventional batteries, coat the terminals with dielectric grease or petroleum jelly.
5. Connect and tighten the red (positive) cable first.
6. Connect and tighten the black (negative) cable last.
7. Secure the battery hold-down strap.
8. Verify that cables are properly routed. Cables should be safely tucked away at the front and rear of the battery.

MAINTENANCE

Battery

Battery Storage

Whenever the vehicle is not used for a period of three months or more, remove the battery from the vehicle, ensure that it's fully charged, and store it out of the sun in a cool, dry place. Check battery voltage each month during storage and recharge as needed to maintain a full charge.

Polaris recommends maintaining battery charge by using a Polaris Battery Tender charger or by charging about once a month to make up for normal self-discharge. Battery Tender can be left connected during the storage period, and will automatically charge the battery if the voltage drops below a pre-determined point. See page 124 for the part numbers of Polaris products.

Battery Fluid (Conventional Battery)

A poorly maintained battery will deteriorate rapidly. Check the battery fluid level often. Maintain the fluid level between the upper and lower level marks.

Add only distilled water. Tap water contains minerals that are harmful to a battery.

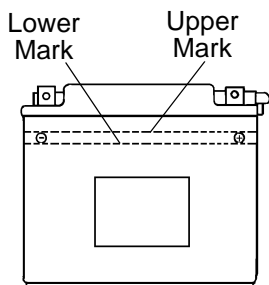

Battery

Battery Charging (Conventional Battery)

1. Remove the battery from the vehicle to prevent damage from leaking or spilled electrolyte during charging. See page 104.
2. Charge the battery with a charging output no larger than 1/10 of the battery's amp/hr rating. Charge as needed to raise the specific gravity to 1.270 or greater.
3. Reinstall the battery. See page 105. Make sure the positive terminal is toward the front of the vehicle.

Battery Charging (Sealed Battery)

The following battery charging instructions apply only to the installation of a sealed battery. Read all instructions before proceeding with the installation of this battery.

The sealed battery is already filled with electrolyte and has been sealed and *fully charged* at the factory. *Never* pry the sealing strip off or add any other fluid to this battery.

The single most important thing about maintaining a sealed battery is to keep it fully charged. Since the battery is sealed and the sealing strip cannot be removed, you must use a voltmeter or multimeter to measure DC voltage.

WARNING! An overheated battery may explode, causing severe injury or death. Always watch charging times carefully. Stop charging if the battery becomes very warm to the touch. Allow it to cool before resuming charging.

Tip:

For a refresh charge, follow all instructions carefully.

1. Check the battery voltage with a voltmeter or multimeter. A fully charged battery will register 12.8 V or higher.
2. If the voltage is less than 12.8 volts, recharge the battery at 1.2 amps or less until battery voltage is 12.8 or greater.
3. When using an automatic charger, refer to the charger manufacturer's instructions for recharging. When using a constant current charger, use the guidelines on the next page for recharging.

MAINTENANCE

Battery

Battery Charging (Sealed Battery)

Always verify battery condition before and 1-2 hours after the end of charging.

State of Charge	Voltage	Action	Charge Time (Using constant current charger @ standard amps specified on top of battery)
100%	12.8-13.0 volts	None, check at 3 mos. from date of manufacture	None required
75%-100%	12.5-12.8 volts	May need slight charge, if no charge given, check in 3 months	3-6 hours
50%-75%	12.0-12.5 volts	Needs charge	5-11 hours
25%-50%	11.5-12.0 volts	Needs charge	At least 13 hours, verify state of charge
0%-25%	11.5 volts or less	Needs charge with desulfating charger	At least 20 hours

Cleaning and Storage

Washing the Vehicle

Keeping your Polaris vehicle clean will not only improve its appearance but it can also extend the life of various components.

NOTICE: High water pressure may damage components. Polaris recommends washing the vehicle by hand or with a garden hose, using mild soap.

Certain products, including insect repellents and chemicals, will damage plastic surfaces. Do not allow these types of products to contact the vehicle.

The best and safest way to clean your Polaris vehicle is with a garden hose and a pail of mild soap and water.

1. Use a professional-type washing cloth, cleaning the upper body first and the lower parts last.
2. Rinse with clean water frequently.
3. Dry surfaces with a chamois to prevent water spots.

Washing Tips

- Avoid the use of harsh cleaners, which can scratch the finish.
- Do not use a power washer to clean the vehicle.
- Do not use medium to heavy duty compounds on the finish.
- Always use clean cloths and pads for cleaning and polishing. Old or reused cloths and pads may contain dirt particles that will scratch the finish.

MAINTENANCE

Cleaning and Storage

Washing the Vehicle

If a high pressure water system is used for cleaning (not recommended), exercise extreme caution. The water may damage components and could remove paint and decals. Avoid directing the water stream at the following items:

- Wheel bearings
- Radiator
- Transmission seals
- Cab and body panels
- Electrical components
- Switches and controls
- Fuel system components
- Labels and decals

If an informational or graphic label becomes illegible or comes off, contact your Polaris dealer to purchase a replacement. Replacement *safety* labels are provided by Polaris at no charge.

Grease all zerk fittings immediately after washing. Allow the engine to run for a while to evaporate any water that may have entered the engine or exhaust system.

Polishing the Vehicle

Polaris recommends the use of common household aerosol furniture polish for polishing the finish on your Polaris vehicle. Follow the instructions on the container.

Polishing Tips

- Avoid the use of automotive products, some of which can scratch the finish of your vehicle.
- Always use clean cloths and pads for cleaning and polishing. Old or reused cloths and pads may contain dirt particles that will scratch the finish.

Cleaning and Storage

Chrome Wheel Care (if equipped)

Proper maintenance will protect chrome wheels from corrosion, preserve wheel life and ensure a "like new" appearance for many years. Chrome wheels exposed to road salt (or salt in the air in coastal areas) are more susceptible to corrosion if not properly cleaned. Clean chrome wheels more often if they're exposed to salt or other corrosive elements.

1. Wash chrome wheels frequently. Use a mild detergent. Never use abrasive cleaners on plated or painted surfaces.
2. Rinse well with clear water. Soap, detergents, salt, dirt, mud and other elements can cause corrosion.
3. Polish the clean chrome wheels periodically. Use an automotive grade chrome polish.
4. Routinely and liberally apply a weather resistant wax to each polished chrome wheel. Choose a product suitable for chrome finishes. Read and follow the product labels and instructions.

Removing Corrosion

If light rust is found on the chrome finish, use steel wool (#0000-OTT grade) to remove it. Gently rub the affected areas with the steel wool until the corrosion has been removed. Clean and polish the wheel as outlined above.

MAINTENANCE

Cleaning and Storage

Storage Tips

NOTICE: Starting the engine during the storage period will disturb the protective film created by fogging and damage could occur. Never start the engine during the storage period.

Clean the Exterior

Make any necessary repairs and then clean the vehicle as recommended. See page 109.

Stabilize the Fuel

1. Fill the fuel tank.
2. Add Polaris Carbon Clean Fuel Treatment or Polaris Fuel Stabilizer. Follow the instructions on the container for the recommended amount. Carbon Clean removes water from fuel systems, stabilizes fuel and removes carbon deposits from pistons, rings, valves and exhaust systems.
3. Allow the engine to run for 15-20 minutes to allow the stabilizer to disperse through the entire fuel delivery system.

Oil and Filter

Change the oil and filter. See page 73.

Air Filter / Air Box

1. Inspect and clean (or replace) the pre-cleaner and air filter.
2. Clean the air box.
3. Drain the sediment tube.

Cleaning and Storage

Storage Tips

Fluid Levels

Inspect the following fluid levels. Change fluids as recommended in the Periodic Maintenance Chart beginning on page 67.

- Demand drive unit (front gearcase)
- ADC fluid (ADC models) (change every two years)
- Rear gearcase
- Middle gearcase
- Transmission
- Brake fluid (change every two years and any time the fluid looks dark or contaminated)
- Coolant (test strength)

Fog the Engine

1. Treat the fuel system with Polaris Carbon Clean, following the instructions on the can. Run the engine for several minutes so the Carbon Clean reaches the injectors. Stop the engine.
2. Remove the spark plugs and add 2-3 tablespoons of Premium 4 Synthetic 0W40 engine oil. To access the plug holes, use a section of clear 1/4" hose and a small plastic squeeze bottle filled with the pre-measured amount of oil.
3. Reinstall the spark plugs. Torque to specification.
4. Apply dielectric grease to the inside of each spark plug cap and reinstall the caps onto the plugs.
5. Turn the engine over several times. Oil will be forced in and around the piston rings and ring lands, coating the cylinder with a protective film of fresh oil.
6. If Polaris fuel system additive is not used, the fuel tank, fuel lines, and injectors should be completely drained of gasoline.

MAINTENANCE

Cleaning and Storage

Storage Tips

Inspect and Lubricate

Inspect all cables and lubricate all areas of the vehicle as recommended in the Periodic Maintenance Chart beginning on page 67.

Battery Maintenance

Remove the battery and recharge it as outlined on page 107. Store the battery in a cool, dry place.

Storage Area/Covers

Set the tire pressure and safely support the vehicle with the tires slightly off the ground. Be sure the storage area is well ventilated. Cover the vehicle with a genuine Polaris cover. Do not use plastic or coated materials. They do not allow enough ventilation to prevent condensation, and may promote corrosion and oxidation.

Accessories

Auxiliary power outlets provide 12-volt power for operating accessories. Accessory outlets are available for all models. Polaris also has a wide range of additional accessories available for your vehicle. Always install accessories that are approved for use on this vehicle. Please see your Polaris dealer.

Transporting the Vehicle

Follow these procedures when transporting the vehicle.

1. Stop the engine.
2. Place the transmission in park.
3. Lock the parking brake.
4. Secure the fuel cap, oil cap and seat.
5. Always tie the frame of the vehicle to the transporting unit securely with suitable straps or rope. Do not attach tie straps to the front A-arm bolt pockets, racks or handlebars.
6. Remove the key to prevent loss during transporting.

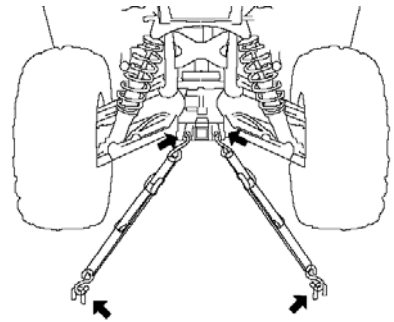
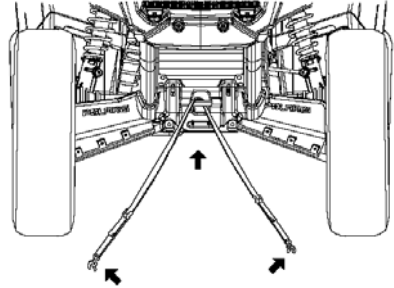

ADJUSTMENTS

Camber and Caster

The camber and caster are non-adjustable.

Rear Springs

The rear shock absorber springs are adjusted by rotating the adjusters either clockwise or counterclockwise to increase or decrease spring tension. Always adjust all rear springs to equal settings.

Accessory springs are available through your Polaris dealer.

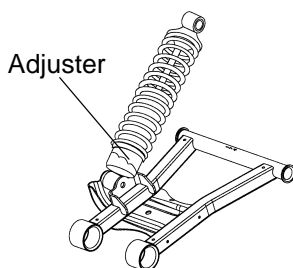

Handlebars

The handlebars can be adjusted for rider preference.

WARNING! Improper adjustment of the handlebars or incorrect torquing of the adjuster block tightening bolts can cause limited steering or loosening of the handlebars, resulting in loss of control and serious injury or death. Follow the adjustment procedures exactly, or see your Polaris dealer for service.

1. Remove the upper headlight pod.
2. Loosen the four handlebar bolts.
3. Adjust the handlebar to the desired height. Be sure the handlebars do not contact the gas tank or any other part of the machine when turned fully to the left or right.
4. Torque the front two bolts to 10-12 ft. lbs. (14-17 Nm), then torque the rear two bolts. A gap of up to 1/8" (3 mm) will remain at the rear of the clamp blocks.

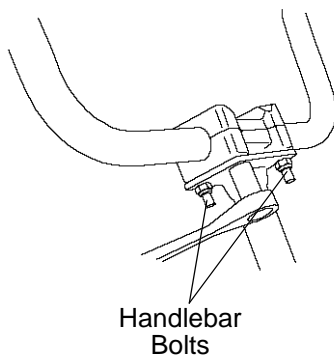

Throttle Body/Idle RPM

Idle RPM is preset by the manufacturer. If the engine idle speed is not satisfactory, please see your Polaris dealer for adjustment.

Throttle Cable Freeplay

Adjust throttle cable freeplay at the handlebar.

1. Locate the throttle cable adjuster at the handlebar.
2. Squeeze the end of the rubber boot and slide it far enough to expose the end of the inline cable adjuster.
3. Loosen the adjuster lock nut.
4. Rotate the boot to turn the adjuster until $1/16"$ to $1/8"$ (1.5-3 mm) of freeplay is achieved at the thumb lever. While adjusting freeplay, be sure to flip the throttle lever back and forth.
5. Tighten the lock nut.
6. Squeeze the end of the rubber boot and slide it over the cable adjuster to its original position.

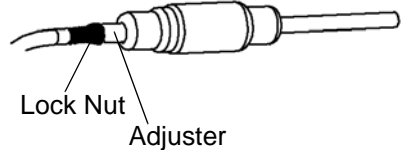
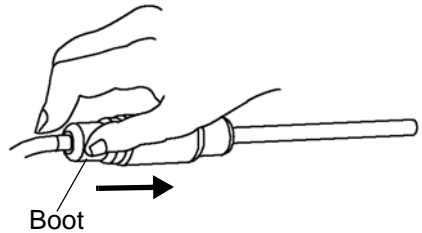
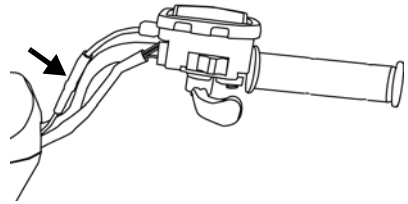

TROUBLESHOOTING

Drive Belt Wear/Burn

Possible Cause	Solution
Driving onto a pickup or tall trailer in high range	Use low range during loading.
Starting out going up a steep incline	Use low range or turn around using the K-turn (see page 58).
Driving at low RPM or ground speed (3-7 MPH)	Drive at a higher speed or use low range more frequently. See page 102.
Insufficient warm-up at low ambient temperatures	Warm the engine at least 5 minutes. With the transmission in neutral, advance the throttle to about 1/8 throttle in short bursts, 5 to 7 times. The belt will become more flexible and prevent belt burning.
Slow/easy clutch engagement	Use the throttle quickly and effectively.
Towing/pushing at low RPM/low ground speed	Use low range only.
Utility use/plowing	Use low range only.
Stuck in mud or snow	Shift the transmission to low range and carefully use fast, aggressive throttle application to engage clutch. WARNING! Excessive throttle may cause loss of control and vehicle overturn.
Climbing over large objects from a stopped position	Shift the transmission to low range and carefully use fast, brief, aggressive throttle application to engage clutch. WARNING! Excessive throttle may cause loss of control and vehicle overturn.
Belt slippage from water or snow ingestion into the PVT system	Dry out the PVT. See page 102. Inspect clutch seals for damage if repeated leaking occurs.
Clutch malfunction	See your Polaris dealer.
Poor engine performance	Check for fouled plugs or foreign material in gas tank or fuel lines. See your dealer.
Slippage from failure to warm up belt	Always warm up the belt by operating below 30 mph for one mile (5 miles or more when temperature is below freezing).
Wrong or missing belt	Install the recommended belt.
Improper break-in	Always break in a new belt and/or clutch. See page 47.

TROUBLESHOOTING

Engine Doesn't Turn Over

Possible Cause	Solution
Low battery voltage	Recharge the battery to 12.8 VDC
Loose battery connections	Check all connections and tighten
Loose solenoid connections	Check all connections and tighten

Engine Turns Over, Fails to Start

Possible Cause	Solution
Out of fuel	Refuel, cycle key to ON position three times for 5 seconds each, then start
Clogged fuel filter	Replace the filter
Water is present in fuel	Drain the fuel system and refuel
Old or non-recommended fuel	Replace with fresh recommended fuel
Fouled or defective spark plugs	Inspect plugs and replace if necessary
No spark to spark plug	Inspect plugs, verify stop switch is on
Water or fuel in crankcase	Immediately see your Polaris dealer
Low battery voltage	Recharge the battery to 12.8 VDC
Mechanical failure	See your dealer

Engine Backfires

Possible Cause	Solution
Weak spark from spark plug	Inspect, clean and/or replace spark plugs
Incorrect spark plug gap or heat range	Set gap to specs or replace plugs
Old or non-recommended fuel	Replace with fresh recommended fuel
Incorrectly installed spark plug wires	See your dealer
Incorrect ignition timing	See your dealer
Mechanical failure	See your dealer
Loose ignition connections	Check all connections and tighten
Water present in fuel	Replace with fresh recommended fuel

TROUBLESHOOTING

Engine Pings or Knocks

Possible Cause	Solution
Poor quality or low octane fuel	Replace with recommended fuel
Incorrect ignition timing	See your dealer
Incorrect spark plug gap or heat range	Set gap to specs or replace plugs

Engine Runs Irregularly, Stalls or Misfires

Possible Cause	Solution
Fouled or defective spark plugs	Inspect, clean and/or replace spark plugs
Worn or defective spark plug wires	See your dealer
Incorrect spark plug gap or heat range	Set gap to specs or replace plugs
Loose ignition connections	Check all connections and tighten
Water present in fuel	Replace with new fuel
Low battery voltage	Recharge battery to 12.8 VDC
Kinked or plugged fuel tank vent line	Inspect and replace
Incorrect fuel	Replace with recommended fuel
Clogged air filter	Inspect and clean or replace
Reverse speed limiter malfunction	See your dealer
Electronic throttle control malfunction	See your dealer
Other mechanical failure	See your dealer

Possible Lean Fuel Cause	Solution
Low or contaminated fuel	Add or change fuel, clean the fuel system
Kinked or plugged fuel tank vent line	Inspect and replace
Low octane fuel	Replace with recommended fuel
Clogged fuel filter	Replace filter
Incorrect fuel	Replace with recommended fuel

Possible Rich Fuel Cause	Solution
Fuel is very high octane	Replace with lower octane fuel
Stopping/starting without adequate warm-up	Allow engine to warm up before operating and/or stopping
Incorrect fuel	Replace with recommended fuel
Clogged air filter	Inspect and clean or replace

TROUBLESHOOTING

Engine Stops or Loses Power

Possible Cause	Solution
Out of fuel	Refuel, cycle key to ON position three times for 5 seconds each, then start
Kinked or plugged fuel vent line	Inspect and replace
Water is present in fuel	Replace with new fuel
Fouled or defective spark plugs	Inspect, clean and/or replace spark plug
Worn or defective spark plug wires	See your dealer
Incorrect spark plug gap or heat range	Set gap to specs or replace plug
Loose ignition connections	Check all connections and tighten
Low battery voltage	Recharge the battery to 12.8 VDC
Incorrect fuel	Replace with fresh recommended fuel
Clogged air filter	Inspect and clean or replace
Reverse speed limiter malfunction	See your dealer
Electronic throttle control malfunction	See your dealer
Other mechanical failure	See your dealer
Overheated engine	Clean radiator screen and core, clean engine exterior, see your dealer

Engine Overheating

Possible Cause	Solution
Debris lodged in screen	Remove and clean the screen. Pull on the top portion of the screen, then remove the lower portion.
Plugged Radiator	Use a garden hose to flush any debris from the radiator fins. NOTE: High pressure washers can deform the radiator fins and reduce cooling efficiency.

SPECIFICATIONS

Sportsman Big Boss 6X6 800 EFI

Maximum Weight Capacity	1115 lbs. (507 kg) (includes operator, cargo, accessories)
Fuel Capacity	4.1 gal. (15.5 l)
Engine Oil Capacity	2 qts. (1.9 l)
Coolant Capacity	3.6 qts. (3.4 l)
Demand Drive Fluid Capacity	9.3 oz. (275 ml)
Rear Gearcase Oil Capacity	5 oz. (150 ml)
Mid Gearcase Oil Capacity	17 oz. (500 ml)
Transmission Oil Capacity	15 oz. (450 ml)
Front Rack/Storage Box Capacity	100 lbs. (45 kg)
Cargo Box Capacity	800 lbs. (363 kg)
Receiver Hitch Tongue Capacity	150 lbs. (68 kg)
Hitch Towing Rating	1500 lbs. (680.4 kg)
Unbraked Trailer Towing Capacity*	2127 lbs. (965 kg)
Overall Length	112 in. (284 cm)
Overall Width	48 in. (122 cm)
Overall Height	48 in. (122 cm)
Wheelbase	79.5 in. (202 cm)
Ground Clearance	10.5 in. (27 cm)
Dry Weight	1060 lbs. (481 kg)
Minimum Turning Radius	152 in. (386 cm) unloaded
Engine	EH076OLE020
Displacement	760 cc
Bore x Stroke	80 x 76
Alternator Output	500 Watts @ 3000 rpm
Compression Ratio	10:1
Starting System	Electric
Fuel System	Electronic Fuel Injection
Ignition System	ECU
Ignition Timing	8 BTDC @ 2000 RPM
Spark Plug / Gap	RC7YC / .035 in. (0.9 mm)
Lubrication System	Pressurized Wet Sump
Driving System Type	Automatic PVT (Polaris Variable Transmission)
Front Suspension	MacPherson strut with 8.2" (21 cm) travel
Rear Suspension	Progressive rate with 6.1" (15.5 cm) travel

* Based on EU Directive 76/432/EC

SPECIFICATIONS

Sportsman Big Boss 6X6 800 EFI

Transmission	Automatic PVT with E-Z Shift H/L/N/R/P
Gear Reduction, Low	7.49:1
Gear Reduction, Reverse	5.11:1
Gear Reduction, High	3.05:1
Drive Ratio, Front	3.82:1
Drive Ratio, Final	3.10:1
Tires/Pressure, Front	25x8-12 / 7 psi (48.3 kPa)
Tires/Pressure, Center	25x11-12 / 10 psi (68.9 kPa)
Tires/Pressure, Rear	25x11-12 / 10 psi (68.9 kPa)
Brakes, Front	Hydraulic Disc
Brakes, Rear	Hydraulic Disc
Brakes, Auxiliary	Hydraulic Disc
Brake, Parking	Hydraulic lock, all wheel
Headlight	1 Single Beam on Headlight Pod (50 watt) 2 Single Beam on Bumper (37.5 watt)
Taillights	8.26 watts
Brake Light	26.9 watts
Instrument Cluster	LCD

Clutching

Altitude		Shift Weight	Drive Clutch Spring	Driven Clutch Spring	Helix*
Meters (Feet)	0-1800 (0-6000)	21-74 PN 5632117	Red/White PN 7043349	Red PN 3234452	EBS PN 3234604
	1800-3700 (6000-12000)	21-70 PN 5632127	Red/White PN 7043349	Red PN 3234452	EBS PN 3234604

*EBS models require no helix/spring adjustment

POLARIS PRODUCTS

Part Number	Description
Engine Lubricant	
2870791	Fogging Oil (12 oz. Aerosol)
2876244	PS-4 PLUS Performance Synthetic 2W-50 4-Cycle Oil (qt.)
2876245	PS-4 PLUS Performance Synthetic 2W-50 4-Cycle Oil (gal.)
Gearcase / Transmission Lubricants	
2873602	Premium AGL Synthetic Gearcase Lubricant (qt./95 l)
2873603	Premium AGL Synthetic Gearcase Lube (gal./3.8 l)
2876144	Active Descent Control (ADC) Fluid
2871653	Premium ATV Angle Drive Fluid (8 oz./237 ml)
2872276	Premium ATV Angle Drive Fluid (2.5 gal./9.5 l)
2870465	Pump for Gallon (3.8 l) Jug
2876251	Demand Drive LT Premium Fluid (8 oz./237 ml)
Coolant	
2871323	60/40 Coolant (gal./3.8 l)
2871534	60/40 Coolant (qt./95 l)
Grease / Specialized Lubricants	
2871312	Grease Gun Kit, Premium All Season
2871322	Premium All Season Grease (3 oz./89 ml cartridge)
2871423	Premium All Season Grease (14 oz./414 ml cartridge)
2871460	Starter Drive Grease
2871515	Premium U-Joint Lube (3 oz./89 ml cartridge)
2871551	Premium U-Joint Lube (14 oz./414 ml cartridge)
2871329	Dielectric Grease (Nyogel™)
Additives / Miscellaneous	
2871326	Carbon Clean Plus
2870652	Fuel Stabilizer
2872189	DOT 4 Brake Fluid
2871956	Loctite™ 565 Thread Sealant
2859044	Polaris Battery Tender™ Charger

WARRANTY

LIMITED WARRANTY

Polaris Sales Inc., 2100 Highway 55, Medina, MN 55340, gives a SIX MONTH LIMITED WARRANTY on all components of the Polaris Light Utility Vehicle against defects in material or workmanship. Polaris also gives a one year limited warranty on the final drive chain for failure due to defects. This warranty covers the parts and labor charges for repair or replacement of defective parts which are covered by this warranty. This warranty begins on the date of purchase. This warranty is transferable to another consumer during the warranty period through a Polaris dealer.

REGISTRATION

At the time of sale, the Warranty Registration Form must be completed by your dealer and submitted to Polaris within ten days. Upon receipt of this registration, Polaris will record the registration for warranty. No verification of registration will be sent to the purchaser as the copy of the Warranty Registration Form will be the warranty entitlement. If you have not signed the original registration and received the customer copy, please contact your dealer immediately. **NO WARRANTY COVERAGE WILL BE ALLOWED UNLESS YOUR VEHICLE IS REGISTERED WITH POLARIS.**

Initial dealer preparation and set-up of your vehicle is very important in ensuring trouble-free operation. Purchasing a machine in the crate or without proper dealer set-up will void your warranty coverage.

WARRANTY

WARRANTY COVERAGE AND EXCLUSIONS: LIMITATIONS OF WARRANTIES AND REMEDIES

The Polaris limited warranty excludes any failures that are not caused by a defect in material or workmanship. This warranty does not cover accidental damage, normal wear and tear, abuse or improper handling. This warranty also does not cover any vehicle that has been altered structurally, neglected, improperly maintained, used for racing, or used for purposes other than for which it was manufactured, or for any damages which occur during trailer transit or as a result of unauthorized service or the use of unauthorized parts. In addition, this warranty does not cover physical damage to paint or finish, stress cracks, tearing or puncturing of upholstery material, corrosion, or defects in parts, components or the vehicle due to fire, explosions or any other cause beyond Polaris' control.

This warranty does not cover the use of unauthorized lubricants, chemicals, or fuels that are not compatible with the vehicle. The exclusive remedy for breach of this warranty shall be, at Polaris' exclusive option, repair or replacement of any defective materials, or components or products. **THE REMEDIES SET FORTH IN THIS WARRANTY ARE THE ONLY REMEDIES AVAILABLE TO ANY PERSON FOR BREACH OF THIS WARRANTY. POLARIS SHALL HAVE NO LIABILITY TO ANY PERSON FOR INCIDENTAL, CONSEQUENTIAL OR SPECIAL DAMAGES OF ANY DESCRIPTION, WHETHER ARISING OUT OF EXPRESS OR IMPLIED WARRANTY OR ANY OTHER CONTRACT, NEGLIGENCE, OR OTHER TORT OR OTHERWISE.** Some states do not permit the exclusion or limitation of incidental or consequential damages or implied warranties, so the above limitations or exclusions may not apply to you if inconsistent with controlling state law.

WARRANTY

ALL IMPLIED WARRANTIES (INCLUDING BUT NOT LIMITED TO THE IMPLIED WARRANTIES OF MERCHANTABILITY AND FITNESS FOR A PARTICULAR PURPOSE) ARE LIMITED IN DURATION TO THE ABOVE SIX MONTH WARRANTY PERIOD. POLARIS FURTHER DISCLAIMS ALL EXPRESS WARRANTIES NOT STATED IN THIS WARRANTY. Some states do not allow limitations on how long an implied warranty lasts, so the above limitation may not apply to you if inconsistent with controlling state law.

HOW TO OBTAIN WARRANTY SERVICE

If your vehicle requires warranty service, you must take it to a Polaris Servicing Dealer. When requesting warranty service you must present your copy of the Warranty Registration form to the dealer. (THE COST OF TRANSPORTATION TO AND FROM THE DEALER IS YOUR RESPONSIBILITY). Polaris suggests that you use your original selling dealer; however, you may use any Polaris Servicing Dealer to perform warranty service.

Please work with your dealer to resolve any warranty issues. Should your dealer require any additional assistance they will contact the appropriate person at Polaris.

This warranty gives you specific legal rights, and you may also have other rights which vary from state to state.

If any of the above terms are void because of state or federal law, all other warranty terms will remain in effect.

Engine Oil

1. Mixing oil brands or using non-recommended oil may cause engine damage. We recommend the use of Polaris engine oil.
2. Damage resulting from the use of non-recommended lubricants may not be covered by warranty.

SPARK ARRESTOR

Polaris warrants that the spark arrestor in this vehicle will meet the efficiency requirements of 43 CFR 8343.1(c) for at least 1000 hours when subjected to normal use and when maintenance and installation are in accordance with Polaris recommendations.

WARRANTY

Exported Vehicles

EXCEPT WHERE SPECIFICALLY REQUIRED BY LAW, THERE IS NO WARRANTY OR SERVICE BULLETIN COVERAGE ON THIS VEHICLE IF IT IS SOLD OUTSIDE THE COUNTRY OF THE SELLING DEALER'S AUTHORIZED LOCATION.

This policy does not apply to vehicles that have received authorization for export from Polaris Industries. Dealers may not give authorization for export. You should consult an authorized dealer to determine this vehicle's warranty or service bulletin coverage if you have any questions.

This policy does not apply to vehicles registered to government officials or military personnel on assignment outside the country of the selling dealer's authorized location.

This policy does not apply to Safety Recalls.

How to Get Service

In the Country where your vehicle was purchased:

Warranty or Service Bulletin repairs must be done by an authorized Polaris dealer. If you move or are traveling within the country where your vehicle was purchased, Warranty or Service Bulletin repairs may be requested from any authorized Polaris dealer who sells the same line as your vehicle.

Outside the Country where your vehicle was purchased:

If you are traveling temporarily outside the country where your vehicle was purchased, you should take your vehicle to an authorized Polaris dealer. You must show the dealer photo identification from the country of the selling dealer's authorized location as proof of residence. Upon residence verification, the servicing dealer will be authorized to perform the warranty repair.

If You Move:

If you move to another country, be sure to contact Polaris Customer Assistance and the customs department of the destination country before you move. Vehicles importation rules vary considerably from country to country. You may be required to present documentation of your move to Polaris Industries in order to continue your warranty coverage. You may also be required to obtain documentation from Polaris Industries in order to register your vehicle in your new country.

Exported Vehicles

How to Get Service

If Purchased From A Private Party:

If you purchase a Polaris product from a private citizen outside of the country in which the vehicle was originally purchased, all warranty coverage will be denied.

Notice

If your vehicle is registered outside of the country where it was purchased, and you have not followed the procedure set out above, your vehicle will no longer be eligible for warranty or service bulletin coverage of any kind. (Vehicles registered to Government officials or military personnel on assignment outside of the country where the vehicle was purchased will continue to be covered by the basic warranty.)

For questions call Polaris Customer Assistance:

United States: 1-888-704-5290

Canada: 1-204-925-7100

WARRANTY

U.S.A. EPA Emissions Limited Warranty

This All Terrain Vehicle (ATV) or Off Road Utility Vehicle (ORUV) emissions limited warranty is in addition to the Polaris standard limited warranty for this vehicle.

Polaris warrants that this vehicle is; (1) designed, built, and equipped to conform at the time of initial sale with the requirements of 40 CFR 1051 and, (2) free from defects in materials and workmanship that may keep it from meeting these requirements.

The emissions warranty period for this vehicle begins on the date the vehicle is delivered to the original retail purchaser and ends 30 months (2.5 years) after that date, after 5000 km (3100 miles), or after 500 hours of operation, whichever comes first.

This emission-related warranty covers components whose failure would increase an engine's emissions, including electronic controls, fuel injection, exhaust-gas recirculation, aftertreatment, or any other system utilized in this vehicle to control emissions. Replacing or repairing other components not covered by this emissions warranty or the standard warranty is the responsibility of the owner; including the parts, labor and other costs associated with recommended maintenance.

The exclusive remedy for breach of this limited warranty shall be, at the exclusive option of Polaris, repair or replacement of any defective materials, components or products. **THE REMEDIES SET FORTH IN THIS LIMITED WARRANTY ARE THE ONLY REMEDIES AVAILABLE TO ANY PERSON FOR BREACH OF THIS WARRANTY. POLARIS SHALL HAVE NO LIABILITY TO ANY PERSON FOR INCIDENTAL, CONSEQUENTIAL OR SPECIAL DAMAGES OF ANY DESCRIPTION, WHETHER ARISING OUT OF EXPRESS OR IMPLIED WARRANTY OR ANY OTHER CONTRACT, NEGLIGENCE OR OTHER TORT OR OTHERWISE.**

ALL IMPLIED WARRANTIES (INCLUDING BUT NOT LIMITED TO ANY IMPLIED WARRANTIES OF MERCHANTABILITY AND FITNESS FOR A PARTICULAR PURPOSE) ARE LIMITED IN DURATION TO THE WARRANTY PERIOD DESCRIBED HEREIN. POLARIS DISCLAIMS ALL EXPRESS WARRANTIES NOT STATED IN THIS WARRANTY. Some states do not allow limitations on how long an implied warranty lasts, so the above limitation may not apply if it is inconsistent with the controlling state law.

This limited warranty excludes failures not caused by a defect in material or workmanship. This limited warranty does not cover damage due to accidents, abuse or improper handling, maintenance or use. This limited warranty also does not cover any engine that has been structurally altered, or any engine that has been used in racing competition. This limited warranty also does not cover physical damage, corrosion or defects caused by fire, explosions or other similar causes beyond the control of Polaris.

If you have any questions regarding your warranty rights and responsibilities, you should contact the Polaris Warranty Department at 1-888-704-5290.

MAINTENANCE LOG

Present this section of your manual to your dealer each time your vehicle is serviced. This will provide you and future owners with an accurate log of maintenance and services performed.

DATE	MILES (KM) OR HOURS	TECHNICIAN	SERVICE PERFORMED / COMMENTS

MAINTENANCE LOG

DATE	MILES (KM) OR HOURS	TECHNICIAN	SERVICE PERFORMED / COMMENTS

Free Manuals Download Website

<http://myh66.com>

<http://usermanuals.us>

<http://www.somanuals.com>

<http://www.4manuals.cc>

<http://www.manual-lib.com>

<http://www.404manual.com>

<http://www.luxmanual.com>

<http://aubethermostatmanual.com>

Golf course search by state

<http://golfingnear.com>

Email search by domain

<http://emailbydomain.com>

Auto manuals search

<http://auto.somanuals.com>

TV manuals search

<http://tv.somanuals.com>