



POLARIS[®]
The Way Out.

2006 Sawtooth

Owner's Manual for Maintenance and Safety

**Read this manual carefully. It contains important safety information.
This is an adult vehicle only.
Operation is prohibited for those under 16 years of age.**

WARNING

Improper vehicle use can result in SEVERE INJURY or DEATH.



**ALWAYS USE
AN APPROVED
HELMET AND
PROTECTIVE
GEAR**



**NEVER USE
ON PUBLIC
ROADS**



**NEVER CARRY
PASSENGERS**



**NEVER USE
WITH DRUGS
OR ALCOHOL**

NEVER:

- Operate without proper training or instruction.
- Operate on public roads. A collision can occur with another vehicle.
- Operate at speeds too fast for your skills or the conditions.
- Use ALCOHOL or DRUGS before or while operating this vehicle.
- Carry Passengers.

ALWAYS:

- Avoid paved surfaces, which may adversely affect handling and control.
- Use proper RIDING TECHNIQUES to avoid vehicle overturns on hills and rough terrain, and in turns.
- Wear eye protection, helmet and protective apparel.

**READ OWNER'S MANUAL.
FOLLOW ALL INSTRUCTIONS AND WARNINGS.**



For your nearest Polaris dealer,
call 1-800-POLARIS
or visit www.polarisindustries.com
Polaris Sales Inc., 2100 Hwy. 55,
Medina, MN 55340
Phone (763) 417-8650 Fax (763) 542-0599
Part No. 9920278
Printed in Taiwan and in USA

 **WARNING**

The engine exhaust from this product contains chemicals known to cause cancer, birth defects or other reproductive harm.

A card containing important ATV safety information should be attached to the owner's manual on the next page. If you cannot locate this card, or if it has been removed, please call 1-800-342-3764 for assistance.

WELCOME

Thank you for purchasing a Polaris vehicle, and welcome to our world-wide family of Polaris owners. We proudly produce an exciting line of utility and recreational products.

- Snowmobiles
- All-terrain vehicles (ATVs)
- *RANGER* utility vehicles
- Victory motorcycles

We believe Polaris sets a standard of excellence for all utility and recreational vehicles manufactured in the world today. Many years of experience have gone into the engineering, design, and development of your Polaris vehicle, making it the finest machine we've ever produced.

For safe and enjoyable operation of your vehicle, be sure to follow the instructions and recommendations in this owner's manual. Your manual contains instructions for minor maintenance, but information about major repairs is outlined in the Polaris Service Manual and should be performed only by a Factory Certified Master Service Dealer (MSD) Technician.

Your Polaris dealer knows your vehicle best and is interested in your total satisfaction. Be sure to return to your dealership for all of your service needs during, and after, the warranty period.

We also take great pride in our complete line of apparel, parts and accessories, available through our online store at www.purepolaris.com. Have your accessories and clothing delivered right to your door!



POLARIS[®]
The Way Out.

Copyright 2005 Polaris Sales Inc. All information contained within this publication is based on the latest product information at the time of publication. Due to constant improvements in the design and quality of production components, some minor discrepancies may result between the actual vehicle and the information presented in this publication. Depictions and/or procedures in this publication are intended for reference use only. No liability can be accepted for omissions or inaccuracies. Any reprinting or reuse of the depictions and/or procedures contained within, whether whole or in part, is expressly prohibited.

Printed in Taiwan and in U.S.A.

2006 Sawtooth Owner's Manual P/N 9920278

TABLE OF CONTENTS

VEHICLE IDENTIFICATION NUMBERS	4
SAFETY	5
FEATURES AND CONTROLS	36
OPERATION	46
EMISSION CONTROL SYSTEMS	64
MAINTENANCE AND LUBRICATION	65
SPECIFICATIONS	100
POLARIS PRODUCTS	103
TROUBLESHOOTING	104
WARRANTY	107
MAINTENANCE LOG	111
INDEX	114

VEHICLE IDENTIFICATION NUMBERS

Record your ATV's identification numbers in the spaces provided. Remove the spare key and store it in a safe place. If both keys are lost, the ignition switch must be replaced.

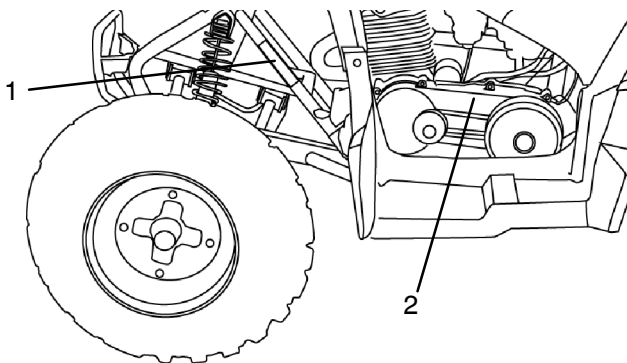

Vehicle Model Number: _____

Frame VIN (1): _____

Engine Serial Number (2): _____

SAFETY

Operator Safety

WARNING

Failure to follow the warnings contained in this manual can result in serious injury or death.

A Polaris ATV is not a toy and can be hazardous to operate. This vehicle handles differently than other vehicles, such as motorcycles and cars. A collision or rollover can occur quickly, even during routine maneuvers like turning, or driving on hills or over obstacles, if you fail to take proper precautions.

Read and understand your owner's manual and all warnings before operating a Polaris ATV.

Age Restrictions

This vehicle is an **ADULT VEHICLE ONLY**. Operation is prohibited for anyone under 16 years of age.

Safety Training

ATV safety training is a top priority for Polaris. When you purchased your new ATV, your dealer instructed you on the authorized *ATV RiderCourse*sm available to you and your eligible family members. This training is included in the purchase price of your ATV. Polaris strongly encourages you and your eligible family members who will be riding the ATV to take the *ATV RiderCourse*sm. You were also provided with printed materials that explain safe operating procedures. You should review this information on a regular basis.

If you purchased a used Polaris ATV, you can take the *ATV RiderCourse*sm by calling ATV Enrollment Express at (800) 887-2887 or by visiting www.atvsafety.org. Purchasers of a used Polaris ATV will be charged for this training.

A Polaris ATV is an off-road vehicle. Familiarize yourself with all laws and regulations concerning the operation of this vehicle in your area.

We strongly advise you to strictly follow the recommended maintenance program outlined in your owner's manual. This preventive maintenance program is designed to ensure that all critical components on your vehicle are thoroughly inspected at specific intervals.

Operator Safety

Know Your Vehicle and Riding Area

You are responsible for your personal safety, the safety of others and the protection of the environment. Read and understand your owner's manual. It includes important information about Quadricycle safety.

Ride responsibly. Know all laws and regulations concerning the operation of this vehicle in your area.

Signal Words and Symbols

The following signal words and symbols appear throughout this manual and on your ATV. Your safety is involved when these words and symbols are used. Become familiar with their meanings before reading the manual.



The *safety alert symbol*, on your vehicle or in this manual, alerts you to the potential for personal injury.



WARNING

The *safety alert warning* indicates a potential hazard that may result in serious injury or death.



CAUTION

The *safety alert caution* indicates a potential hazard that may result in minor personal injury or damage to the vehicle.

CAUTION

A *caution* indicates a situation that may result in damage to the vehicle.

NOTE:

A *note* will alert you to important information or instructions.

SAFETY

Operator Safety

WARNING

Serious injury or death can result if you do not follow these instructions and procedures, which are outlined in further detail within your owner's manual.

- Read this manual and all labels carefully, and follow the operating procedures described.
- Never operate an ATV without proper instruction. *Take a training course.* Purchasers of a new Polaris ATV and their eligible family members are entitled to take the *ATV RiderCoursesm*. Contact ATV Enrollment Express at (800) 887-2887 or visit www.atvsafety.org for information on enrollment in the *ATV RiderCoursesm*.
- Never allow anyone under 16 years of age to operate this ATV.
- Never permit a guest to operate the ATV unless the guest has read this manual and all product labels and has completed a certified safety training course.
- Always avoid operating an ATV on paved surfaces, including sidewalks, driveways, parking lots, and streets.
- Never operate an ATV on a public street, road or highway, including a dirt or gravel road.
- Never operate an ATV without wearing an approved helmet that fits properly. Always wear eye protection (goggles or face shield), gloves, boots, a long-sleeved shirt or jacket, and long pants.
- Never consume alcohol or drugs before or while operating an ATV.
- Never operate at excessive speeds. Travel at speeds appropriate for the terrain, visibility and operating conditions, and your experience.
- Never attempt wheelies, jumps or other stunts.
- Always inspect your ATV before each use to make sure it's in safe operating condition. Always follow the inspection and maintenance procedures and schedules outlined in your owner's manual.
- Always keep both hands on the handlebars and both feet on the footrests of the ATV during operation.

Operator Safety

- Always travel slowly and use extra caution when operating on unfamiliar terrain. Be alert to changing terrain conditions.
- Never operate on excessively rough, slippery, or loose terrain.
- Always follow proper turning procedures as described in this manual. Practice turning at low speeds before attempting to turn at faster speeds. Do not turn at excessive speeds.
- Always have the ATV inspected by an authorized Polaris dealer if it's been involved in an accident.
- Never operate on hills too steep for the ATV or for your abilities. Practice on smaller hills before attempting larger hills.
- Always follow proper procedures for climbing hills. Check the terrain carefully before ascend a hill. Never climb hills with excessively slippery or loose surfaces. Shift your weight forward. Never open the throttle suddenly or make sudden gear changes. Never go over the top of a hill at high speed.
- Always follow proper procedures for going downhill and for braking on hills. Check the terrain carefully before you start down a hill. Shift your weight backward. Never go down a hill at high speed. Avoid going down a hill at an angle, which would cause the vehicle to lean sharply to one side. Travel straight down the hill when possible.
- Always follow proper procedures for crossing the side of a hill. Avoid hills with excessively slippery or loose surfaces. Shift your weight to the uphill side of the ATV. Never attempt to turn the ATV around on any hill until you've mastered (on level ground) the turning technique outlined in this manual. Avoid crossing the side of a steep hill when possible.

SAFETY

Operator Safety

- Always use proper procedures if you stall or roll backwards while climbing a hill. To avoid stalling, maintain a steady speed when climbing a hill. If you stall or roll backwards, follow the special procedure for braking described in this manual. Always dismount on the uphill side, or to either side if the ATV is pointed straight uphill. Turn the ATV around and remount following the procedure described in this manual.
- Always check for obstacles before operating in a new area. Never attempt to operate over large obstacles, such as rocks or fallen trees. Always follow proper procedures when operating over obstacles as described in this manual.
- Always be careful of skidding or sliding. On slippery surfaces like ice, travel slowly and use extra caution to reduce the chance of skidding or sliding out of control.
- Avoid operating the ATV through deep or fast-flowing water. If it's unavoidable, travel slowly, balance your weight carefully, avoid sudden movements, and maintain a slow and steady forward motion. Do not make sudden turns or stops, and do not make sudden throttle changes.
- Wet brakes may have reduced stopping ability. Test your brakes after leaving water. If necessary, apply them lightly several times to allow friction to dry out the pads.
- Always check for obstacles or people behind the ATV before operating in reverse. When it's safe to proceed in reverse, move slowly and avoid turning at sharp angles.
- Always use the size and type of tires specified for your ATV, and always maintain tire pressure as recommended.

Operator Safety

- Never modify an ATV through improper installation or use of accessories.
- Never exceed the stated load capacity for your ATV. Cargo must be properly distributed and securely attached. Reduce speed and follow the instructions in this manual for carrying cargo or towing. Allow a greater distance for braking.
- Always remove the ignition key when the vehicle is not in use to prevent unauthorized use or accidental starting.

FOR MORE INFORMATION ABOUT ATV SAFETY, call the Consumer Product Safety Commission at 1-800-638-2772, or visit www.cpsc.gov, visit www.atvsafety.org, or call Polaris at 1-800-342-3764.

Equipment Modifications

We are concerned for the safety of our customers and for the general public. Therefore, we strongly recommend that consumers do not install on a Polaris ATV any equipment that may increase the speed or power of the vehicle, or make any other modifications to the vehicle for these purposes. Any modifications to the original equipment of the vehicle create a substantial safety hazard and increase the risk of bodily injury.

The warranty on your Polaris ATV is terminated if any equipment has been added to the vehicle, or if any modifications have been made to the vehicle, that increase its speed or power.

NOTE: The addition of certain accessories, including (but not limited to) mowers, blades, tires, sprayers, or large racks, may change the handling characteristics of the vehicle. Use only Polaris-approved accessories, and familiarize yourself with their function and effect on the vehicle.

SAFETY

Operator Safety

WARNING

POTENTIAL HAZARD

Operating this ATV without proper instruction.

WHAT CAN HAPPEN

The risk of an accident is greatly increased if the operator does not know how to operate the ATV properly in different situations and on different types of terrain.

HOW TO AVOID THE HAZARD

Beginning and inexperienced operators should complete the ATV *RiderCourse*sm offered by Polaris through the SVIA. They should then regularly practice the skills learned in the course and the operating techniques described in the Owner's Manual.

For more information about the ATV *RiderCourse*sm contact ATV Enrollment Express at (800) 887-2887 or visit www.atvsafety.org

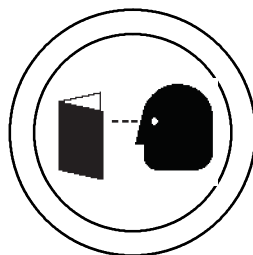

WARNING

POTENTIAL HAZARD

Failure to follow the age recommendations for this ATV.

WHAT CAN HAPPEN

Severe injury and/or death could occur if a child under the minimum age recommendation operates an ATV.

Even though a child may be within the recommended age group for operating some ATVs, he/she may not have the skills, abilities, or judgment needed to operate an ATV safely and could be susceptible to accident or injury.

HOW TO AVOID THE HAZARD

No one under the age of 16 should operate a Polaris ATV.



Operator Safety

⚠ WARNING

POTENTIAL HAZARD

Carrying a passenger on an ATV.

WHAT CAN HAPPEN

Carrying a passenger greatly reduces the operator's ability to balance and control the ATV, which could cause an accident and injury to the operator and/or passenger.

HOW TO AVOID THE HAZARD

Never carry a passenger. The purpose of the long seat is to allow the operator to shift position as needed during operation. It is not intended for carrying passengers.

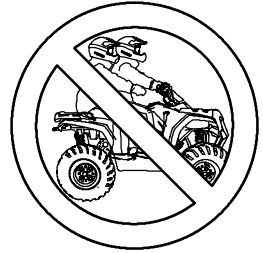

⚠ WARNING

POTENTIAL HAZARD

Carrying a passenger on one of the racks.

WHAT CAN HAPPEN

A passenger riding on a rack could be ejected from the vehicle unexpectedly or may contact moving components, both of which can result in severe injury or death.

HOW TO AVOID THE HAZARD

Never allow passengers to ride on one of the racks.



SAFETY

Operator Safety

WARNING

POTENTIAL HAZARD

Operating an ATV on paved surfaces, including sidewalks, paths, parking lots, and driveways.

WHAT CAN HAPPEN

ATV tires are designed for off-road use. Operating on paved surfaces may seriously affect the handling and control of the ATV and could result in loss of control, accident, and/or injury.

HOW TO AVOID THE HAZARD

Avoid operating the ATV on pavement. If it's unavoidable, travel slowly and avoid sudden turns or stops.



WARNING

POTENTIAL HAZARD

Operating this ATV on public streets, roads or highways.

WHAT CAN HAPPEN

The ATV could collide with another vehicle.

HOW TO AVOID THE HAZARD

Never operate the ATV on any public street, road or highway, including dirt and gravel roads. In many states it's illegal to operate ATVs on public streets, roads and highways.

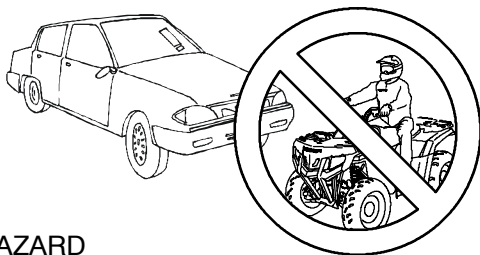

Operator Safety

⚠ WARNING

POTENTIAL HAZARD

Operating this ATV without wearing an approved helmet, eye protection and protective clothing.

WHAT CAN HAPPEN

Operating an ATV without an approved helmet increases the risk of a severe head injury or death in the event of an accident.

Operating without eye protection could result in an accident and could increase the chance of a severe injury in the event of an accident.

HOW TO AVOID THE HAZARD

Always wear an approved helmet that fits properly.

Always wear eye protection (goggles or face shield), gloves, boots, long-sleeved shirt or jacket, and long pants.

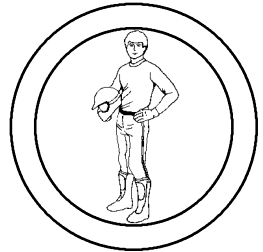

⚠ WARNING

POTENTIAL HAZARD

Operating the ATV after consuming alcohol or drugs.

WHAT CAN HAPPEN

Consumption of alcohol and/or drugs could seriously affect operator judgment. Reaction time may be slower and operator balance and perception could be affected.

Consuming alcohol and/or drugs before or while operating an ATV could result in an accident causing severe injury or death.

HOW TO AVOID THE HAZARD

Never consume alcohol or drugs before or while operating an ATV.



SAFETY

Operator Safety

⚠ WARNING

POTENTIAL HAZARD

Operating the ATV at excessive speeds.

WHAT CAN HAPPEN

Excessive speed increases the operator's chance of losing control of the ATV, which can result in an accident.

HOW TO AVOID THE HAZARD

Always operate the ATV at a speed that's proper for the terrain, visibility and operating conditions, and your experience.

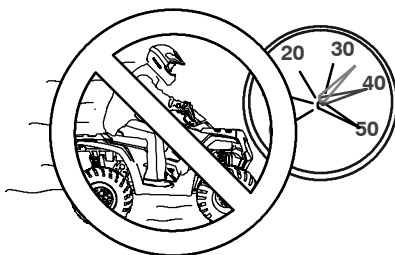

⚠ WARNING

POTENTIAL HAZARD

Attempting wheelies, jumps and other stunts.

WHAT CAN HAPPEN

Attempting stunts increases the chance of an accident, including an overturn.

HOW TO AVOID THE HAZARD

Never attempt wheelies, jumps, or other stunts. Avoid exhibition driving.

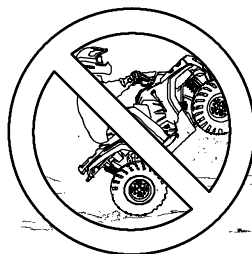

Operator Safety

⚠ WARNING

POTENTIAL HAZARD

Failure to inspect the ATV before operating.

Failure to properly maintain the ATV.

WHAT CAN HAPPEN

Poor maintenance increases the possibility of an accident or equipment damage.

HOW TO AVOID THE HAZARD

Always inspect your ATV before each use to make sure it's in safe operating condition.

Always follow the inspection and maintenance procedures and schedules described in the owner's manual.

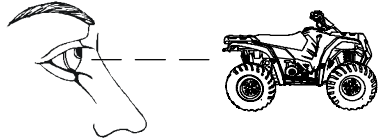

⚠ WARNING

POTENTIAL HAZARD

Removing hands from the handlebars or feet from the footrests during operation.

WHAT CAN HAPPEN

Removing even one hand or foot can reduce ability to control the vehicle or could cause loss of balance and ejection from the ATV.

If the operator's foot is not firmly planted on the footrest, it could come into contact with the rear wheels and lead to accident or injury.

HOW TO AVOID THE HAZARD

Always keep both hands on the handlebars and both feet on the footrests of the ATV during operation.



SAFETY

Operator Safety

WARNING

POTENTIAL HAZARD

Failure to use extra caution when operating the ATV on unfamiliar terrain.

WHAT CAN HAPPEN

Unfamiliar terrain may contain hidden rocks, bumps, or holes that could cause loss of control or overturn.

HOW TO AVOID THE HAZARD

Travel slowly and use extra caution when operating on unfamiliar terrain. Always be alert to changing terrain conditions.



WARNING

POTENTIAL HAZARD

Failure to use extra caution when operating on excessively rough, slippery or loose terrain.

WHAT CAN HAPPEN

Operating on excessively rough, slippery or loose terrain could cause loss of traction or loss of control, which could result in an accident or overturn.

HOW TO AVOID THE HAZARD

Do not operate on excessively rough, slippery or loose terrain until you've learned and practiced the skills necessary to control the ATV on such terrain.

Always use extra caution on rough, slippery or loose terrain.



Operator Safety

⚠ WARNING

POTENTIAL HAZARD

Turning improperly.

WHAT CAN HAPPEN

Improper turns could cause loss of control and lead to a collision or overturn.

HOW TO AVOID THE HAZARD

Always follow proper procedures for turning as described in the owner's manual.

Practice turning at slow speeds before attempting to turn at faster speeds.

Never turn at excessive speed.



⚠ WARNING

POTENTIAL HAZARD

Operating on excessively steep hills.

WHAT CAN HAPPEN

The vehicle may overturn.

HOW TO AVOID THE HAZARD

Never operate on hills too steep for the ATV or for your abilities. Never operate the ATV on hills steeper than 25°.

Practice on smaller hills before attempting large hills.



SAFETY

Operator Safety

WARNING

POTENTIAL HAZARD

Operating on frozen bodies of water.

WHAT CAN HAPPEN

Severe injury or death can result if the ATV and/or the operator fall through the ice.

HOW TO AVOID THE HAZARD

Never operate the ATV on a frozen body of water.

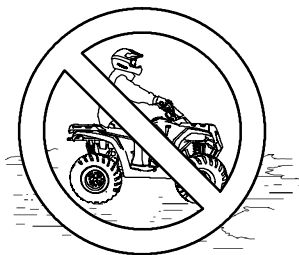

WARNING

POTENTIAL HAZARD

Climbing hills improperly.

WHAT CAN HAPPEN

Improper hill climbing could cause loss of control or overturn.

HOW TO AVOID THE HAZARD

Always follow proper procedures for climbing hills as described in the owner's manual.

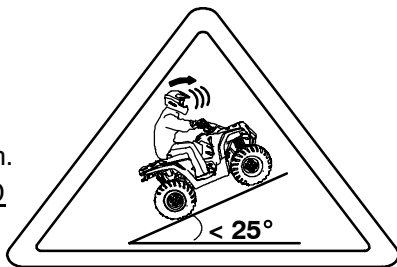

Always check the terrain carefully before ascending any hill.

Never operate the ATV on hills steeper than 25°.

Never climb hills with excessively slippery or loose surfaces.

Shift your weight forward.

Never open the throttle suddenly while traveling uphill. The ATV could flip over backwards.

Never go over the top of any hill at high speed. An obstacle, a sharp drop, or another vehicle or person could be on the other side of the hill.

Operator Safety

WARNING

POTENTIAL HAZARD

Traveling downhill improperly.

WHAT CAN HAPPEN

Improperly descending a hill could cause loss of control or overturn.

HOW TO AVOID THE HAZARD

Always follow proper procedures for traveling down hills as described in the

owner's manual. **NOTE:** A special technique is required when braking while traveling downhill. See page 56.

Always check the terrain carefully before descending a hill.

Shift your weight backward.

Never travel down a hill at high speed.

Avoid traveling down a hill at an angle, which would cause the vehicle to lean sharply to one side. Travel straight down the hill when possible. Never travel backwards down a hill.

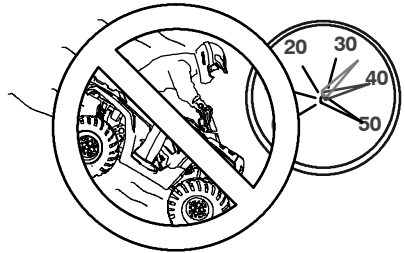
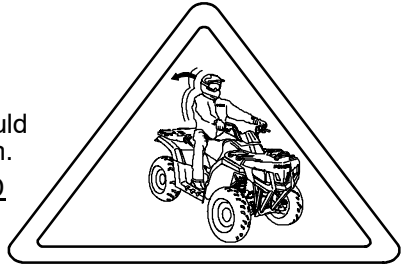

SAFETY

Operator Safety

⚠ WARNING

POTENTIAL HAZARD

Improperly crossing hills and turning on hills.

WHAT CAN HAPPEN

Improperly crossing or turning as hills could cause loss of control or overturn.

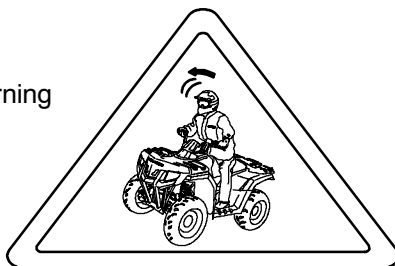

HOW TO AVOID THE HAZARD

Never attempt to turn the ATV around on any hill until you've mastered the turning technique (on level ground) as described in the owner's manual. See page 58. Use extra caution when turning on any hill.

Avoid crossing the side of a steep hill.

When crossing the side of a hill:

Always follow proper procedures as described in the owner's manual.

Avoid hills with excessively slippery or loose surfaces.

Shift your weight to the uphill side of the ATV.

Operator Safety

⚠ WARNING

POTENTIAL HAZARD

Stalling, rolling backwards or improperly dismounting while climbing a hill.

WHAT CAN HAPPEN

The vehicle could overturn.

HOW TO AVOID THE HAZARD

Maintain steady speed when climbing a hill.

If all forward speed is lost:

Keep your weight uphill.

Gradually apply the front brakes (right lever).

When fully stopped, apply the rear brakes and lock the parking brake.

Dismount on uphill side, or to either side if ATV is pointed straight uphill. Turn the ATV around and remount, following the procedure described in the owner's manual. See page 58.

If the ATV begins rolling backwards:

Keep weight uphill.

Apply the front brake gradually.

Never apply the rear brake while rolling backwards.

Never apply engine power.

When fully stopped, apply the rear brake as well, and then lock the parking brake.

Dismount on uphill side, or to either side if ATV is pointed straight uphill. Turn the ATV around and remount, following the procedure described in the owner's manual. See page 58.

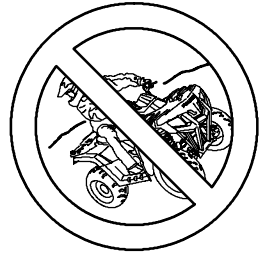

SAFETY

Operator Safety

WARNING

POTENTIAL HAZARD

Improperly operating over obstacles.

WHAT CAN HAPPEN

Operating over obstacles could cause loss of control or overturn.

HOW TO AVOID THE HAZARD

Before operating in a new area, check for obstacles.

Avoid operating over large obstacles such as rocks and fallen trees when possible. If unavoidable, use extreme caution and always follow proper procedures as outlined in the owner's manual.

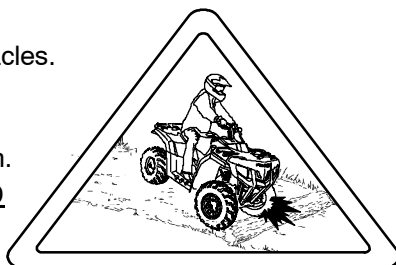

WARNING

POTENTIAL HAZARD

Skidding or sliding.

WHAT CAN HAPPEN

Skidding or sliding can cause loss of control.

If the tires regain traction unexpectedly, the ATV could overturn.

HOW TO AVOID THE HAZARD

On slippery surfaces such as ice, travel slowly and use extra caution to reduce the chance of skidding or sliding out of control.



Operator Safety

⚠ WARNING

POTENTIAL HAZARD

Operating the ATV through deep or fast-flowing water.

WHAT CAN HAPPEN

Tires may float, causing loss of traction and loss of control, which could lead to an accident or overturn.

HOW TO AVOID THE HAZARD

Avoid operating the ATV through deep or fast-flowing water. If it's unavoidable to enter water that exceeds the recommended maximum depth (see page 60), travel slowly, balance your weight carefully, avoid sudden movements, and maintain a slow and steady forward motion. Do not make sudden turns or stops, and do not make sudden throttle changes.

Wet brakes may have reduced stopping ability. Always test the brakes after leaving water. If necessary, apply them several times to let friction dry out the pads.



SAFETY

Operator Safety

⚠ WARNING

POTENTIAL HAZARD

Improperly operating in reverse.

WHAT CAN HAPPEN

The ATV could collide with an obstacle or person, resulting in severe injury.

HOW TO AVOID THE HAZARD

Before shifting into reverse gear, always come to a complete stop and check for obstacles or people behind the ATV. When it's safe to proceed, back slowly.

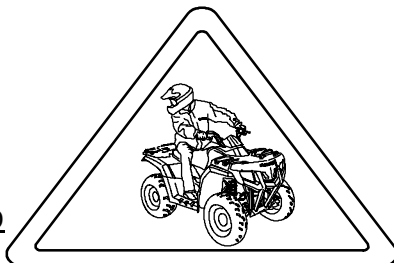

⚠ WARNING

POTENTIAL HAZARD

Operating this ATV with improper tires, or with improper or uneven tire pressure.

WHAT CAN HAPPEN

Use of improper tires, or operation of the ATV with improper or uneven tire pressure, could cause loss of control or accident.

HOW TO AVOID THE HAZARD

Always use the size and type of tires specified for the ATV.

Always maintain proper tire pressure as specified.

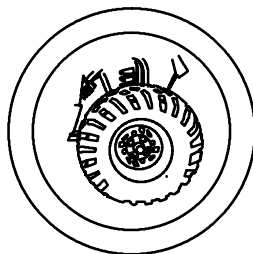
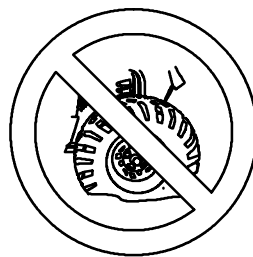

Operator Safety

⚠ WARNING

POTENTIAL HAZARD

Operating the ATV with improper modifications.

WHAT CAN HAPPEN

Improper installation of accessories or modification of the ATV may cause changes in handling which could lead to an accident.

HOW TO AVOID THE HAZARD

Never modify the ATV through improper installation or use of accessories. All parts and accessories added to the vehicle must be genuine Polaris Industries Inc. or equivalent components designed for use on this ATV and should be installed and used according to approved instructions. See your authorized Polaris ATV dealer for more information.

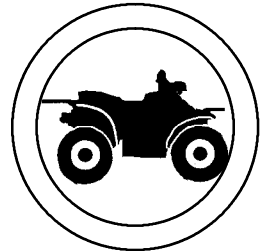

SAFETY

Operator Safety

⚠ WARNING

POTENTIAL HAZARD

Overloading the ATV or carrying/towing cargo improperly.

WHAT CAN HAPPEN

Overloading and towing can cause changes in vehicle handling, which could lead to loss of control or an accident.

HOW TO AVOID THE HAZARD

Never exceed the stated load capacity for this ATV.

Cargo should be properly distributed and securely attached.

Reduce speed when carrying cargo or pulling a trailer. Allow a greater distance for braking.

Always follow the instructions in the owner's manual for carrying cargo or pulling a trailer. See pages 52-53.

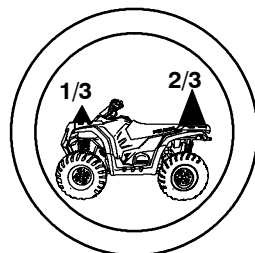

Operator Safety

WARNING

Operating the ATV on streets or roads, especially in darkness, could result in an accident and serious injury or death.

Your ATV is not equipped with highway-approved lights. It's designed for and must be used for *off-road use only*. Use caution and drive at reduced speeds in conditions of reduced visibility such as fog, rain and darkness.

WARNING

Leaving the keys in the ignition can lead to unauthorized use of the vehicle resulting in serious injury or death. Always remove the ignition key when the vehicle is not in use.

WARNING

After any overturn or accident, have a qualified service dealer inspect the entire vehicle for possible damage, including (but not limited to) brakes, throttle and steering systems.

WARNING

Safe operation of this rider-active vehicle requires good judgement and physical skills. Persons with cognitive or physical disabilities who operate this vehicle have an increased risk of overturn and loss of control, which could result in severe injury or death.

CAUTION

Always keep combustible materials away from the exhaust system. Exposure to the hot components could result in a fire.

SAFETY

Safety Decals and Locations

Warning decals have been placed on the ATV for your protection. Read and follow the instructions of the decals and other warnings on the ATV carefully. If any of the decals shown in this manual differ from the decals on your ATV, always read and follow the instructions of the decals *on the ATV*.

If any decal becomes illegible or comes off, contact your Polaris dealer to purchase a replacement. Replacement *safety* decals are provided by Polaris at no charge. The part number is printed on the decal.

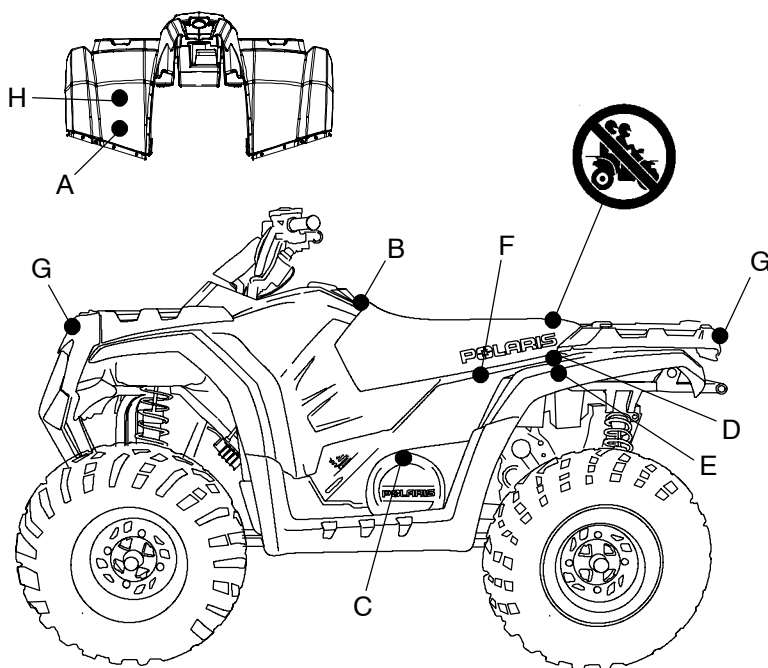

⚠️ WARNING

- Never operate this ATV on HILLS steeper than 25 degrees $\triangle 25^\circ$. To prevent flipover on hilly terrain, when going up or down, use throttle and brakes gradually.
- REVERSE operation can be dangerous even at low speeds. Steering becomes difficult. To prevent flipover, avoid sudden braking or sharp turns.
- PARKING BRAKE may relax when used for more than 5 minutes. When parking on grades, leave shift in forward.

7172665

⚠️ AVERTISSEMENT

- Ne jamais conduire ce VTT sur des pentes à plus de 25 degrés. Pour éviter un retournement lors de la montée ou de la descente de pentes, utiliser les freins et l'accélérateur graduellement.
- La conduite en MARCHÉ ARRIÈRE peut être dangereuse, même à basse vitesse. Le braquage est plus difficile. Pour éviter le retournement, éviter les freinages brusques et les virages serrés.
- Le FREIN DE STATIONNEMENT peut se desserrer s'il reste engagé pendant plus de 5 minutes. Lors du stationnement sur une pente, engager la marche avant.

7172665-F

Safety Decals and Locations

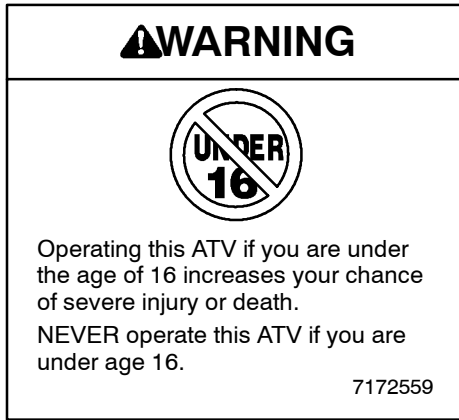

B



C

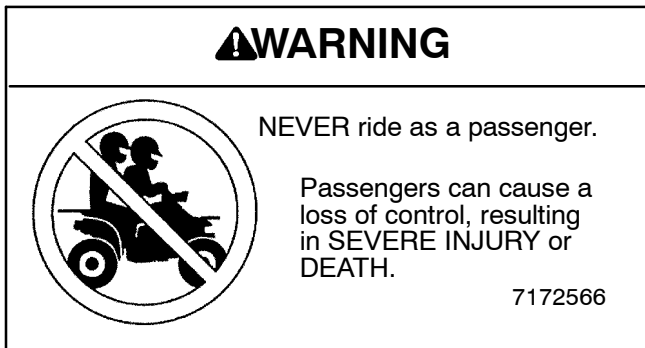

D

SAFETY

Safety Decals and Locations

WARNING

IMPROPER TIRE PRESSURE OR OVERLOADING can cause loss of control resulting in SEVERE INJURY OR DEATH.

TIRE PRESSURE IN PSI (KPa): FRONT 4 (27,6) REAR 3 (20,7)

MAXIMUM WEIGHT CAPACITY (Gross Vehicle Weight) INCLUDING MACHINE, DRIVER AND CARGO IS 765 LBS. (348 KG)

Reduce speed and allow greater distance for braking when carrying cargo. Overloading or carrying tall, off-center, or unsecured loads will increase your risk of losing control. Loads should be centered, carried as low as possible, and firmly secured to the racks. With dual racks, load distribution 1/3 front 2/3 rear is best. For stability on rough or hilly terrain, reduce speed and cargo. Do not block headlight. Be careful if load extends over the side of the rack.

Read Owner's Manual for more detailed loading information.

7172664

E

- Operation of this vehicle without the air filter element will severely damage the engine.
- Clean pre-filter element often, more frequent cleaning required in dusty conditions. Do not operate vehicle without pre-filter.

ATTENTION

- Specific carburetor jetting and adjustments are required depending on temperature and altitude. See your Owner's Manual.

Factory setting:

40° to 80° F. at 0-3000 feet
(5° to 27° C. at 0-900 meters).

7170007

F

WARNING

- **DO NOT TOW FROM RACK OR BUMPER.** Vehicle damage or tipover may result causing severe injury or death. Tow only from tow hooks or hitch.
- **Max. Rack Loads: Front 45 lbs. (20 kg) Rear 70 lbs. (32 kg).**

7173909

G

Safety Decals and Locations

⚠ WARNING

Improper ATV use can result in **SEVERE INJURY** or **DEATH**



ALWAYS USE AN APPROVED HELMET AND PROTECTIVE GEAR



NEVER USE ON PUBLIC ROADS



NEVER CARRY PASSENGERS



NEVER USE WITH DRUGS OR ALCOHOL

NEVER operate:

- without proper training or instruction
- at speeds too fast for your skills or the conditions
- on public roads - a collision can occur with another vehicle
- with a passenger - passengers affect balance and steering and increase risk of losing control

ALWAYS:

- use proper riding techniques to avoid vehicle overturns on hills and rough terrain and in turns
- avoid paved surfaces - pavement may seriously affect handling and control

**LOCATE AND READ OWNER'S MANUAL.
FOLLOW ALL INSTRUCTIONS AND WARNINGS.**

**IF OWNER'S MANUAL IS MISSING, CONTACT
A POLARIS DEALER FOR A REPLACEMENT.**

© 1997, 20007172560

H



MANUFACTURED
IN TAIWAN

DATE:

VIN:

THIS VEHICLE IS AN ALL TERRAIN VEHICLE AND IS NOT INTENDED FOR USE ON PUBLIC ROADS.

CE VÉHICULE EST UN VÉHICULE TOUT TERRAIN
QUI N'EST PAS DESTINÉ À ÊTRE UTILISÉ SUR
LES CHEMINS PUBLICS.

**VERRIDE
SWITCH**

Reverse Speed is limited.

Reverse override is controlled by the override switch.

See your Owner's Manual.

7079906

SAFETY

Safe Riding Gear

Always wear clothing suited to the type of riding. ATV riding requires special protective clothing for comfort and to reduce the chance of injury.

1. Helmet

Your helmet is the most important piece of protective gear for safe riding. A helmet can prevent a severe head injury.

Select an approved helmet that meets or exceeds your state's safety standards and bears either the Department of Transportation (DOT) label, the American National Standards Institute label (ANSI z90.1), or the Snell Memorial Foundation label.

2. Eye Protection

Do not depend on sunglasses for proper eye protection. A pair of goggles or a helmet face shield offer the best protection for your eyes. They should be kept clean and be of shatterproof design (bearing the markings z2.1 or VESC 8).

3. Gloves

Off-road style gloves with knuckle pads are the best for comfort and protection.

4. Boots

The best footwear is a pair of strong over-the-calf boots with heels, like moto-cross boots.

5. Clothing

Always wear long sleeves and long pants to protect arms and legs. Riding pants with kneepads and a jersey with shoulder pads provide the best protection.

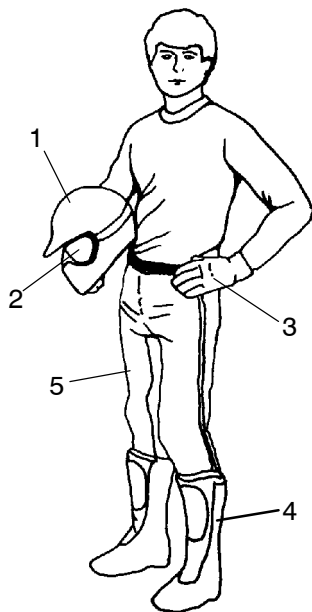

Fuel Safety

WARNING

Gasoline is highly flammable and explosive under certain conditions.

- Always exercise extreme caution whenever handling gasoline.
- Always refuel with the engine stopped, and outdoors or in a well ventilated area.
- Do not smoke or allow open flames or sparks in or near the area where refueling is performed or where gasoline is stored.
- Do not overfill the tank. Do not fill the tank neck.
- If gasoline spills on your skin or clothing, immediately wash it off with soap and water and change clothing.
- Never start the engine or let it run in an enclosed area. Engine exhaust fumes are poisonous and can cause loss of consciousness or death in a short time.
- Turn the fuel valve off whenever the ATV is stored or parked.

WARNING

The engine exhaust from this product contains chemicals known to cause cancer, birth defects or other reproductive harm.

Operate this vehicle only outdoors or in well-ventilated areas.

FEATURES AND CONTROLS

Electrical Switches

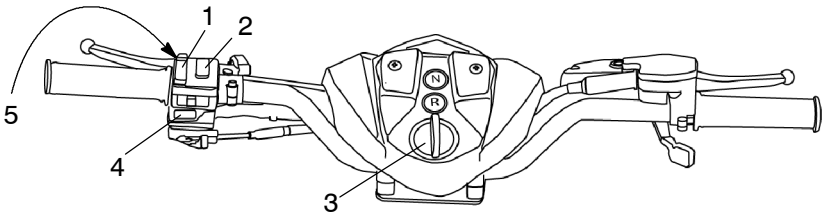

1. **Light Switch/Hi-Lo Beam Control** - The lights won't turn on unless the main key switch is on.
2. **Engine Stop Switch** - The engine will not start or run when the switch is in the *OFF* position. Its purpose is to provide the operator with a quick means of engine shutdown in case of an emergency. To stop the engine, press the lower end of the rocker switch down to the *OFF* position. Before starting the engine, press the upper end of the switch down to the *ON* position.
3. **Main Key Switch** - Turn the main key switch clockwise to the *ON* position before starting the engine. Turn the main switch off to stop the engine and end all electrical power to the vehicle.
4. **Start Button** - To start the engine, make sure the stop switch is in the *ON* position. Turn the main key switch on. Press the start button.

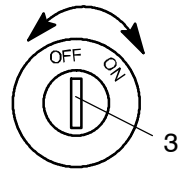
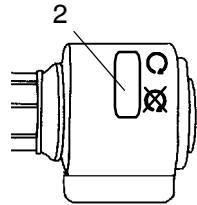

FEATURES AND CONTROLS

Electrical Switches

⚠ WARNING

Activating the override switch while the throttle is open can cause loss of control, resulting in severe injury or death. Do not activate the override switch while the throttle is open.

5. **Override Switch (Reverse Speed Limiter)** - This vehicle is equipped with a reverse speed limiter system. To gain additional power while backing, depress the override switch.

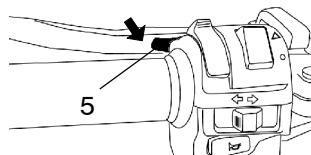

Indicator Lights

Your ATV has neutral and reverse indicator lights.

N: Neutral (Green)

R: Reverse (Amber)

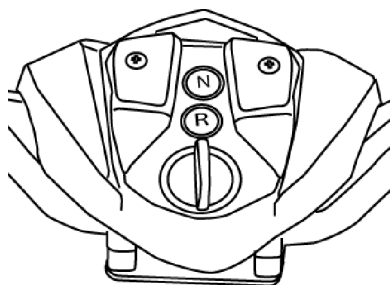

FEATURES AND CONTROLS

Throttle Lever

Press the throttle lever (1) toward the handlebar to increase engine speed and vehicle movement. Engine speed returns to idle when the lever is released.

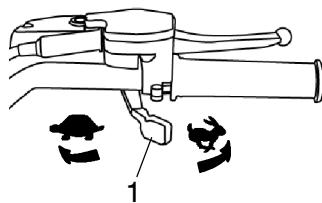

This ATV is equipped with Polaris Electronic Throttle Control (ETC), which is designed to reduce the risk of a frozen or stuck throttle. If the throttle cable should stick in an open position when the operator releases the throttle lever, the engine will stop, and power to the rear wheels will cease.

WARNING

Operating an ATV with sticking or improperly operating throttle controls could cause an accident and lead to severe injury or death.

Never start or operate an ATV with a sticking or improperly operating throttle. Always contact your dealer for service if throttle problems arise.

Failure to check or maintain proper operation of the throttle system can result in an accident if the throttle lever sticks during operation. Always check the lever for free movement and return before starting the engine. Also check occasionally during operation.

WARNING

The Electronic Throttle Control (ETC) stops the engine in the event of a throttle system malfunction and is provided for your safety. Do not attempt to modify the ETC system or replace it with any after market throttle mechanisms.

FEATURES AND CONTROLS

Brakes

Master Cylinder

Check the brake fluid level in the master cylinder before each use of the ATV. The master cylinder (A) is located on the right handlebar.

View the fluid level through the indicator window (B) on the top of the master cylinder. This *eye* will appear dark when the fluid level is full. When fluid is low, the eye will be clear.

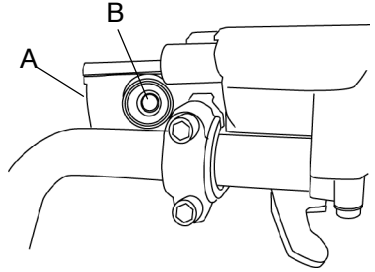

NOTE: When checking the fluid level, position the ATV on level ground with the handlebars turned so the top of the reservoir is level. If the fluid level is low, add DOT 3 brake fluid. **DO NOT OVERFILL.** See page 103 for the part numbers of Polaris products.

WARNING

An over-full master cylinder may cause brake drag or brake lock-up, which could result in serious injury or death. Maintain brake fluid at the recommended level. Do not overfill.

WARNING

After opening a bottle of brake fluid, always discard any unused portion. Never store or use a partial bottle. Brake fluid is hygroscopic, meaning it rapidly absorbs moisture from the air. The moisture causes the boiling temperature of the brake fluid to drop, which can lead to early brake fade and the possibility of an accident and severe injury or death.

FEATURES AND CONTROLS

Brakes

⚠ WARNING

Applying only one brake could cause loss of control and result in serious injury or death. Always apply both brakes at the same time.

Brake Lever (Right)

Squeeze the right brake lever (1) toward the handlebar to apply the hydraulic front wheel brakes. **THIS LEVER DOES NOT APPLY THE REAR BRAKES.**

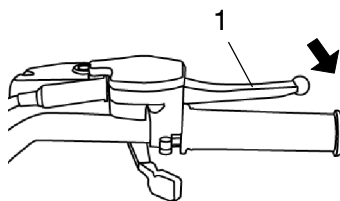

⚠ WARNING

Operating the ATV with a spongy brake lever can result in loss of braking, which could cause an accident.

Never operate the ATV with a spongy-feeling brake lever.

Always test front brake lever travel and master cylinder fluid level before riding. When squeezed, the lever should feel firm. Any sponginess would indicate a possible fluid leak or low master cylinder fluid level, which must be corrected before riding. Contact your dealer for proper diagnosis and repairs.

Brake Lever (Left)

Squeeze the left brake lever (2) toward the handlebar to apply the mechanical rear wheel brakes. **THIS LEVER DOES NOT APPLY THE FRONT BRAKES.**

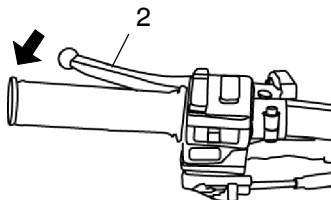

FEATURES AND CONTROLS

Brakes

Foot Brake

The foot brake (1) is a mechanical rear wheel brake. The foot brake is located on the inside of the right footrest. Apply the brake with your right foot. This is identical to squeezing the left brake lever on the handlebar.



NOTE: If the rear wheels slide while using the foot brake, *reduce* brake pedal pressure to brake the rear wheels without skidding.

WARNING

Aggressively applying the rear brake when backing down a hill may cause rear tipover, which could result in serious injury or death.

Use caution when applying the rear brake. Do not aggressively apply the rear brake when going forward. The rear wheels may skid and slide sideways, causing loss of control and serious injury or death.

FEATURES AND CONTROLS

Parking Brake

⚠ WARNING

Operating the ATV while the parking brake is engaged could result in an accident and serious injury or death. Always check to be sure the parking brake is disengaged before operating.

Setting the Parking Brake

1. Squeeze the left brake lever (1).
2. Push the park brake lock (2) down. This will prevent the lever from returning to the released position.
3. To release the parking brake lock, squeeze and release the brake lever. The parking brake will release automatically.

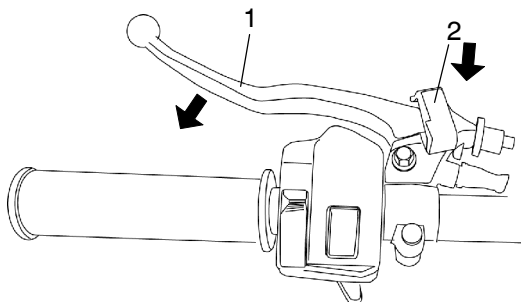

Important Safeguards

- The parking brake may relax if left on for a long period of time. Always block the wheels to prevent rolling.
- Never depend on the parking brake alone if the ATV is parked on a hill. Always block the wheels to prevent rolling.

FEATURES AND CONTROLS

Choke

The choke assists in starting a cold engine. See page 48 for correct choke and throttle settings during starting.

Fuel Filter

The in-line fuel filter should be replaced by your dealer after every 100 hours of operation, or annually. Do not attempt to clean the fuel filter.

Fuel Tank

The fuel tank filler cap (A) is located directly below the handlebar. Use either leaded or unleaded gasoline with a minimum pump octane number of 87=(R+ M/2) octane. Refer to the specifications section beginning on page 100 for tank capacity.

Fuel Valve

The fuel valve (B) is located on the left side of the vehicle.

OFF

Turn the valve off before storage and when transporting.

ON

Turn the valve on for normal operation.

RES

Turn the valve to the reserve setting if the main fuel supply is exhausted. Refuel as soon as possible.

Reserve fuel range is about 7-10 miles (11-16 km).

NOTE: Return the valve to the ON position after refueling.

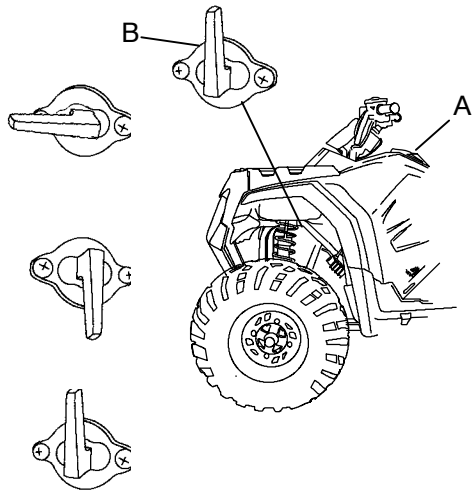

FEATURES AND CONTROLS

Automatic Transmission Gear Selector

The transmission gear selector (A) is located on the right side of the vehicle.

F: Forward Gear

N: Neutral

R: Reverse

Whenever the ATV is left unattended, always place the transmission in gear and lock the parking brake.

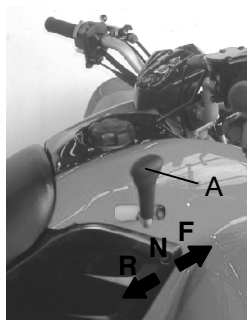

CAUTION

Shifting gears with the engine speed above idle or while the vehicle is moving could cause transmission damage.

To change gears, stop the vehicle, and with the engine idling, move the lever to the desired gear.

FEATURES AND CONTROLS

Kick-Start Lever

If the battery becomes too weak to start the engine, use the kick-start lever to start the engine until the battery is serviced.

1. Position the vehicle on a level surface.
2. Lock the parking brake.
3. Place the transmission in neutral.
1. Fold out the kick-start lever on the left side of the ATV.
2. Make sure the stop switch and main key switch are on.
3. Place your foot on the kick-start. Thrust your heel downward to crank the engine.

NOTE: If the engine is cold, use the choke as outlined on page 48.

4. After the engine has started, fold the kick-start lever back into place.

NOTE: A 10/12 mm wrench is provided in the tool kit for removing or installing the lever. If not installed, make sure the rubber cap is installed on the kick-start shaft to protect the rider. Store the kick-start lever under the seat in the rear cab when not installed.

OPERATION

Break-In Period

The break-in period for your new Polaris 4-cycle ATV is defined as the first ten hours of operation, or the time it takes to use the first two full tanks of gasoline. No single action on your part is as important as following the procedures for a proper break-in. Careful treatment of a new engine will result in more efficient performance and longer life for the engine. Perform the following procedures carefully.

CAUTION

Excessive heat build-up during the first three hours of operation will damage close-fitted engine parts. Do not operate at full throttle or high speeds for extended periods during the first three hours of use.

CAUTION

Mixing brands or using a non-recommended oil may cause serious engine damage. Never substitute or mix oil brands.

1. Fill the fuel tank with gasoline. See page 43.
2. Check the oil level. Add the recommended oil as needed to maintain the oil level in the proper range. See page 71.
3. Drive slowly at first. Select an open area that allows room to familiarize yourself with vehicle operation and handling.
4. Vary throttle positions. Do not operate at sustained idle.
5. Perform regular checks on fluid levels, controls and areas outlined on the daily pre-ride inspection checklist. See page 47.
6. Pull only light loads (if equipped with a hitch).
7. During the break-in period, change both the oil and the filter at 20 hours, 200 miles or one month, whichever comes first. See page 71.

Pre-Ride Inspection

WARNING

If a proper inspection is not done before each use, severe injury or death could result. Always inspect the vehicle before each use to ensure it's in proper operating condition.

Pre-Ride Checklist		
Item	Remarks	See Page
Brake system / lever travel	Ensure proper operation	39, 40, 85, 86
Brake fluid	Ensure proper level	39
Foot brake	Ensure proper operation	41
Front suspension	Inspect, lubricate if necessary	69
Rear suspension	Inspect, lubricate if necessary	69
Steering	Ensure free operation	-
Tires	Inspect condition and pressure	94
Wheels / fasteners	Inspect, ensure fastener tightness	93
Frame nuts, bolts, fasteners	Inspect, ensure tightness	-
Fuel and oil	Ensure proper levels	71
Coolant level (if applicable)	Ensure proper level	-
Coolant hoses (if applicable)	Inspect for leaks	-
Throttle	Ensure proper operation	38, 91
Indicator lights / switches	Ensure operation	36, 37
Engine stop switch	Ensure proper operation	36
Air filter, pre-filter	Inspect, clean	95
Air box sediment tube	Drain deposits whenever visible	-
Headlamp	Check operation, apply dielectric grease when lamp is replaced	76
Brake light / tail lamp	Check operation, apply dielectric grease when lamp is replaced	77
Riding gear	Wear helmet, goggles, protective clothing	34

OPERATION

Cold Weather Operation for 4-Cycle Engines

Internal engine condensation increases as outside temperatures decrease. If the vehicle is used year-round, check the oil level frequently. A rising oil level could indicate condensation in the bottom of the crankcase, which can lead to engine damage. Any condensation must be drained. If the oil level rises to the top of the sight glass, change the oil immediately.

Always operate the engine long enough to reach operating temperature, which reduces condensation.

Starting the Engine

WARNING

Engine exhaust contains poisonous carbon monoxide and can cause loss of consciousness resulting in severe injury or death. Never run an engine in an enclosed area.

1. Position the vehicle on a level surface.
2. Turn the fuel valve on.
3. Sit on the vehicle.
4. If the engine is cold, use full choke by pushing the choke lever (A) all the way to the left. A warm engine will not require the use of the choke.

NOTE: The choke is fully on when the lever is pushed completely to the left. The choke is off when the lever is pushed completely to the right. The choke can be adjusted gradually, depending on how much choke is needed for starting.

5. Place the engine stop switch in the ON position, then turn the main key switch on.

NOTE: Do not press the throttle while starting the engine.



Starting the Engine

6. Squeeze the left brake lever.

NOTE: The starter will not engage unless the rear brake is applied. Always squeeze and hold the left brake lever before attempting to start the engine.

7. Press the start button.
8. Activate the starter for a maximum of five seconds, releasing the button when the engine starts. If it doesn't start, release the starter, wait five seconds, then activate for another five seconds. Repeat until the engine starts.
9. If the engine slows or stops, position the choke lever half way to allow proper engine warm up. Vary the RPM slightly with the throttle to aid in warm up.
10. When the engine idles smoothly, push the choke lever all the way to the right.

CAUTION

Operating the vehicle immediately after starting could cause engine damage. Allow the engine to warm up for several minutes before operating the vehicle.

OPERATION

Driving Safely

Driving Procedures



1. Sit upright. Keep your feet on the footrests. Keep both hands on the handlebars.
2. Start the engine and allow it to warm up, then shift the transmission into gear.
3. Check your surroundings and determine your path of travel.
4. Slowly squeeze the throttle lever toward the handlebar to begin driving. Squeeze the throttle lever further to increase speed.
5. Drive slowly. Practice maneuvering and using the throttle and brakes on level surfaces.

Driving Safely Making Turns



1. To make a turn, steer in the direction of the turn, leaning your upper body to the inside of the turn while supporting your weight on the outer footrest. Use the same leaning technique for turning in reverse.
2. Practice turning at slow speeds before attempting to turn at faster speeds.

⚠ WARNING

Turning at sharp angles or at excessive speeds can result in vehicle overturn and lead to serious injury. Avoid turning at sharp angles. Never turn at high speeds.

OPERATION

Driving Safely

Hauling Cargo and Towing

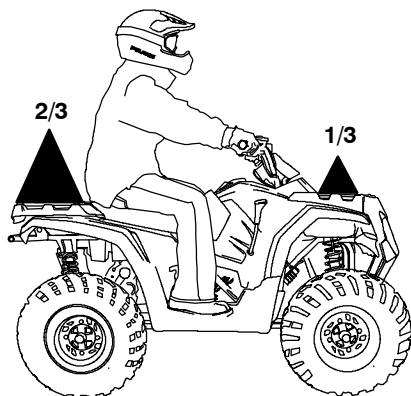

Your ATV has been designed to carry or tow a certain amount of load. Always read and understand the load distribution warning labels on the vehicle, and never exceed the weight capacities outlined in the specifications section of the owner's manual and on the safety decals.

Cargo weight should be evenly distributed ($1/3$ on the front rack and $2/3$ on the rear rack) and mounted as low as possible. When operating over rough or hilly terrain, reduce speed and cargo weight to maintain stable driving conditions. Do not obstruct the headlight beam with cargo.

Do not exceed the maximum capacities when towing. Do not tow any trailer on a grade steeper than 15° .

Maximum Towed Load (Level Ground)	Maximum Vertical Hitch Weight
300 lbs. (136 kg)	30 lbs. (13.6 kg)

Driving Safely

Hauling Cargo and Towing

WARNING

Hauling cargo improperly can alter vehicle handling and may cause loss of control or brake instability and result in serious injury or death. Always follow these precautions when hauling cargo:

- **REDUCE SPEED AND ALLOW GREATER DISTANCES FOR BRAKING WHEN HAULING CARGO.**
- **CARGO WEIGHT DISTRIBUTION** should be 1/3 on the front rack and 2/3 on the rear rack. When operating over rough or hilly terrain, reduce speed and cargo to maintain stable driving conditions. Carrying loads on one rack only increases the possibility of vehicle overturn.
- **CARRY LOADS AS LOW ON THE RACKS AS POSSIBLE.** Carrying loads high on the racks raises the center of gravity of the vehicle and creates a less stable operating condition.
- **SECURE ALL LOADS BEFORE OPERATING.** Unsecured loads can create unstable operating conditions, which could result in loss of control of the vehicle.
- **OPERATE ONLY WITH STABLE AND SAFELY ARRANGED LOADS.** When handling off-centered loads that cannot be centered, securely fasten the load and operate with extra caution. Always attach the tow load to the hitch point designated for your vehicle.
- **HEAVY LOADS CAN CAUSE BRAKING AND CONTROL PROBLEMS.** Use extreme caution when applying brakes with a loaded vehicle. Avoid terrain or situations that may require backing downhill.
- **USE EXTREME CAUTION** when operating with loads that extend over the rack sides. Stability and maneuverability may be adversely affected, causing the vehicle to overturn.
- **DO NOT BLOCK THE FRONT HEADLIGHT BEAM** when carrying loads on the front rack.
- **DO NOT TRAVEL FASTER THAN THE RECOMMENDED SPEEDS.** Vehicle should never exceed 10 mph (16 kph) while towing a load on a level grass surface. Vehicle speed should never exceed 5 mph (8 kph) when towing loads in rough terrain, while cornering, or while ascending or descending a hill.

OPERATION

Driving Safely

Driving on Slippery Surfaces

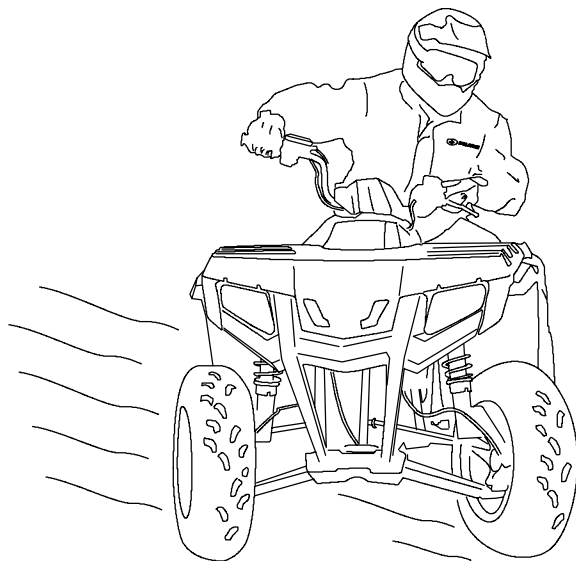

Whenever driving on slippery or loose surfaces such as wet trails, gravel, snow or ice, follow these precautions:

1. Slow down before driving onto slippery surfaces.
2. Use extra caution.
3. Be alert. Watch the trail. Avoid quick, sharp turns.

NOTE: To correct a rear wheel skid, turn the handlebars in the same direction as the skid and shift body weight forward.

⚠ WARNING

Failure to exercise care when operating on slippery surfaces can result in loss of tire traction and cause loss of control, accident, and serious injury or death.

Never apply the brakes during a skid. Do not operate on excessively slippery surfaces. Always reduce speed and use additional caution.

Driving Safely

Driving Uphill

Whenever traveling uphill, follow these precautions:

1. Drive straight uphill.
2. Avoid steep hills (25° maximum).
3. Avoid hills with excessively slippery or loose surfaces.
4. Keep your feet on the footrests.
5. Shift your weight uphill.
6. Drive at a steady rate of speed to avoid stalling.
7. Be alert. Be prepared to take emergency action. This may include dismounting quickly.
8. Never go over the top of a hill at high speed.

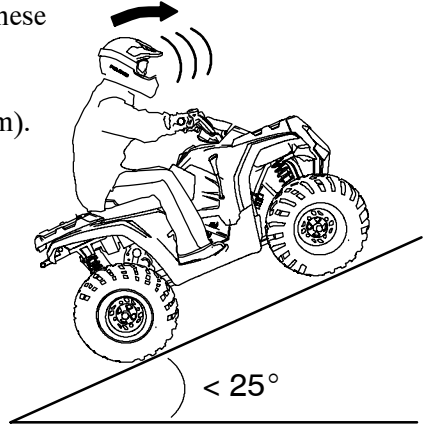

If all forward speed is lost:

1. Keep your weight uphill.

NOTE: *If the vehicle begins rolling downhill, never apply engine power. Never apply the rear brakes while rolling backwards.*

2. Gradually squeeze the right-hand brake lever to engage the front brakes. When fully stopped, apply the rear brake as well, then lock the park brake.
3. Dismount on uphill side, or to either side if ATV is pointed straight uphill. Turn the ATV around and remount, following the procedure described on page 58.

WARNING

Braking and handling are greatly affected when operating in hilly terrain. Improper procedure could cause loss of control or overturn and result in serious injury or death.

Avoid climbing steep hills (25° maximum).

Use extreme caution when operating on hills, and follow proper operating procedures outlined in the owner's manual.

OPERATION

Driving Safely

Driving Downhill



Whenever descending a hill, follow these precautions:

1. Drive straight downhill.
2. Shift your weight rearward.
3. Slow down.
4. Never go down a hill at high speed.
5. Squeeze the (left-hand) rear brake lever *slightly* to aid in slowing. Do not apply the front brakes.
6. Avoid hills with excessively slippery or loose surfaces.
7. Avoid going down a hill at an angle, which can cause the vehicle to pitch sharply to one side.

NOTE: Familiarize yourself with operation of the rear foot brake.

WARNING

Excessive speed can cause loss of control and lead to serious injury or death. Always operate slowly when traveling downhill.

Driving Safely Sidehilling



⚠ WARNING

Improperly crossing hills or turning on hills can result in loss of control or vehicle overturn, resulting in severe injury or death. Avoid crossing the side of a hill when possible. Follow proper procedures as outlined in the owner's manual.

Avoid crossing the side of a hill (sidehilling) if possible. If sidehilling is necessary, follow these precautions:

1. Avoid hills with excessively slippery or loose surfaces.
2. Avoid crossing the sides of steep hills.
3. Slow down.
4. Shift your weight uphill.
5. Keep your feet on the footrests.
6. Steer slightly into the hill.

NOTE: If the vehicle begins to tip, quickly turn the front wheels downhill (if possible) or dismount on the UPHILL side *immediately!*

OPERATION

Driving Safely

Turning Around on a Hill

⚠ WARNING

Improper hill climbing procedures could cause loss of control or overturn and result in serious injury or death.

Avoid climbing steep hills (25° maximum).

Use extreme caution when operating on hills, and follow proper operating procedures outlined in the owner's manual.

If the vehicle stalls while climbing a hill, *never back down the hill!*
Use the K-turn to turn around.

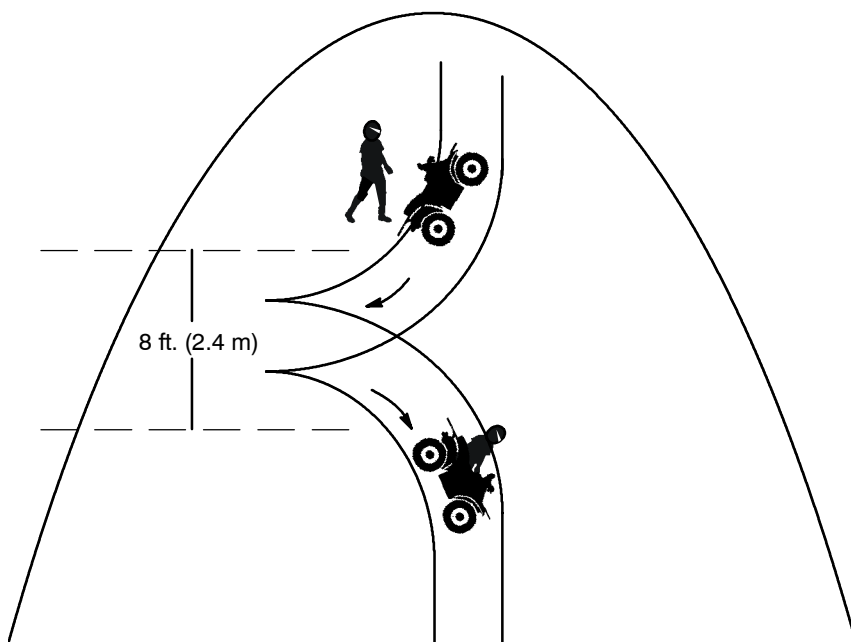

Driving Safely

K-Turn/Turning Around on a Hill

1. Squeeze the front (right) brake lever to stop the vehicle.
2. Keep your weight uphill.
3. Lock the parking brake.
4. Leave the transmission in forward gear and shut off the engine.
5. Dismount on the uphill side of the vehicle, or on either side if the vehicle is pointing straight uphill.
6. Staying uphill of the vehicle, turn the handlebars full left.
7. While holding the brake lever, release the parking brake lock and slowly allow the vehicle to roll around to your right until it's pointing across the hill or slightly downward.
8. Squeeze and hold the left brake lever.
9. Remount the vehicle from the uphill side. Keep your weight uphill.
10. With the transmission still in forward, start the engine.
11. Release the brake and *drive slowly* downhill. Control speed with the *rear brake* until the vehicle is on level ground.

OPERATION

Driving Safely

Driving Through Water

Follow these procedures when operating through water:

1. Check water depths and current before crossing.
2. Avoid operating in water deeper than the bottom of the footrests (A). If it's unavoidable, travel slowly, balance your weight carefully and avoid sudden movements. Maintain a slow and steady forward motion.



- Do not make sudden turns, stops or throttle changes.
3. Choose a crossing where both banks have gradual inclines.
 4. Drive slowly. Avoid rocks and obstacles.
 5. Wet brakes may have reduced stopping ability. Always test your brakes after leaving water. If necessary, apply them lightly several times to allow friction to dry out the pads.

After running the vehicle in water, it's *critical* to have it serviced as outlined in the maintenance chart. See page 65. The following areas need special attention: engine oil, transmission oil, rear gearcase and all grease fittings.

CAUTION

Major engine damage can result if the vehicle is not thoroughly inspected after operation in water. Perform the services outlined in the maintenance chart. If your vehicle becomes immersed or is operated in water that exceeds the footrest level, take it to your dealer for service before starting the engine.

If your vehicle becomes immersed, and it's impossible to take it to a dealer before starting it, follow the steps described on page 79. Have the vehicle serviced by your dealer at the first opportunity.

Driving Safely

Driving Over Obstacles

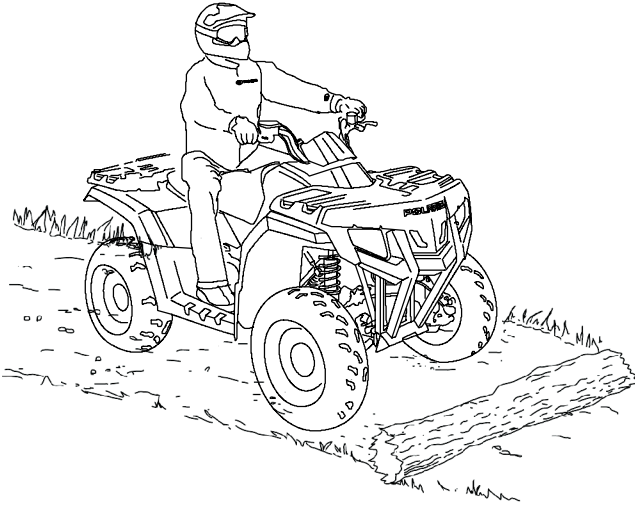

1. Always check for obstacles before operating in a new area.
2. Be alert. Watch the terrain. Use extra caution.
3. Never operate over large obstacles.
4. Avoid hazards such as logs, rocks and low branches.

⚠ WARNING

Severe injury or death can result if your vehicle comes in contact with a hidden obstacle. Not all obstacles are immediately visible. Travel with caution in unfamiliar terrain.

OPERATION

Driving Safely

Driving in Reverse

Follow these precautions when operating in reverse:

1. Avoid backing downhill.
2. Always check for obstacles or people behind the vehicle before backing.
3. Drive slowly.
4. Apply the brakes *lightly* for stopping.
5. Avoid turning at sharp angles.
6. Never apply the throttle suddenly.

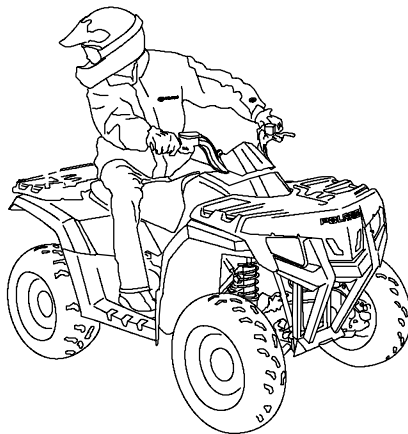

WARNING

Failure to use caution when operating in reverse can result in serious injury or death. Before shifting into reverse, always come to a complete stop and check for obstacles or people behind the vehicle. When it's safe to proceed, back slowly. Avoid backing on inclines. Avoid turning at sharp angles.

Do not use the override switch unless additional power is required for vehicle movement. Use with caution.

NOTE: The override switch should be used with caution as rearward vehicle speed is greatly increased. Do not operate at wide open throttle. Open the throttle just enough to maintain a desired speed.

CAUTION

Excessive throttle operation while in the speed limit mode may cause fuel to build in the exhaust, resulting in engine popping and/or engine damage.

Driving Safely

Parking on an Incline

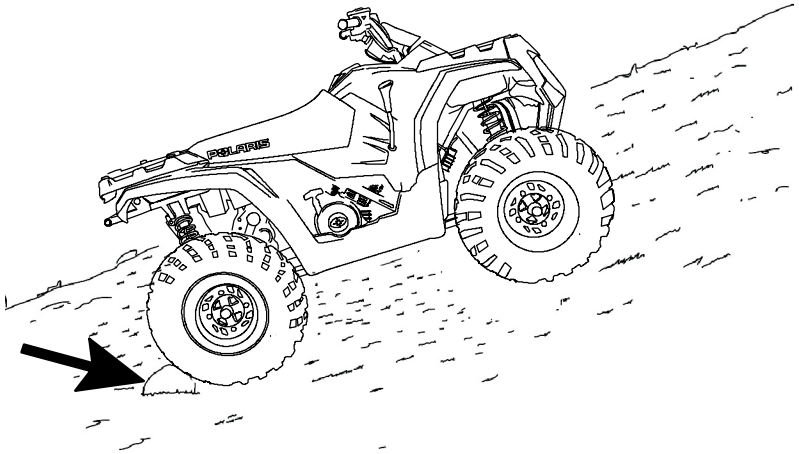

Avoid parking on an incline. If it's unavoidable, follow these precautions:

1. Turn the engine off.
1. Place the transmission in gear and lock the parking brake.
2. Always block the rear wheels on the downhill side.
3. Turn the fuel valve off.

EMISSION CONTROL SYSTEMS

Noise Emission Control System

Do not modify the engine, intake or exhaust components, as doing so may affect compliance with U.S.A. EPA noise control requirements (40 CFR 205) and local noise level requirements.

Operation on Public Lands in the U.S.A.

Your Polaris vehicle has a spark arrestor that was tested and qualified to be in accordance with the USDA Forest Service Standard 5100-1C. Federal law requires that this spark arrestor be installed and functional when the vehicle is operated on public lands.

Operation of off-road vehicles on public lands in the U.S.A. is regulated by 43 CFR 8343. Violations are subject to monetary penalties. Federal regulations can be viewed online at www.gpoaccess.gov/ecfr/.

Crankcase Emission Control System

This engine is equipped with a closed crankcase system. Blow-by gases are forced back to the combustion chamber by the intake system. All exhaust gases exit through the exhaust system.

Exhaust Emission Control System

The emissions from the exhaust of this vehicle are controlled by engine design, including factory-set fuel delivery and ignition. The engine and related components must be maintained at Polaris specifications to achieve optimal performance.

Engine idle speed is the only adjustment Polaris recommends that the operator perform. Any other adjustments should be performed by an authorized Polaris dealer.

The emissions label is located on the clutch cover or engine case near the clutch box.

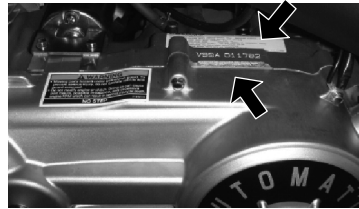

NOTE: The installation of devices that effectively increase exhaust emissions beyond their legal limits will void all manufacturer warranties and may violate laws governing the registration and operation of this vehicle.

Electromagnetic Interference

This spark ignition system complies with Canadian ICES-002.

This vehicle complies with European directives 97/24/EC and 89/336/EEC.

MAINTENANCE AND LUBRICATION

Periodic Maintenance Chart

Careful periodic maintenance will help keep your vehicle in the safest, most reliable condition. Inspection, adjustment and lubrication of important components are explained in the periodic maintenance chart.

Inspect, clean, lubricate, adjust and replace parts as necessary. When inspection reveals the need for replacement parts, use genuine Polaris parts available from your Polaris dealer.

Record maintenance and service in the Maintenance Log beginning on page 111.

NOTE: Service and adjustments are important for proper vehicle operation. If you're not familiar with safe service and adjustment procedures, have a qualified dealer perform these operations.

Maintenance intervals in the following charts are based upon average riding conditions and an average vehicle speed of approximately 10 miles per hour. Vehicles subjected to severe use must be inspected and serviced more frequently.

Severe Use Definition

- Frequent immersion in mud, water or sand
- Racing or race-style high RPM use
- Prolonged low speed, heavy load operation
- Extended idle
- Short trip cold weather operation

Maintenance Chart Key

- ▶ Perform these procedures more frequently for vehicles subjected to severe use.
- E Emission-related service (Failure to conduct this maintenance will not void the emissions warranty but may affect emissions.)
- Have an authorized Polaris dealer perform these services.

WARNING

Improperly performing the procedures marked with a ■ could result in component failure and lead to serious injury or death. Have an authorized Polaris dealer perform these services.

MAINTENANCE AND LUBRICATION

Periodic Maintenance Chart

Perform all services at whichever maintenance interval is reached first.

	Item	Maintenance Interval (whichever comes first)			Remarks
		Hours	Calendar	Miles (Km)	
■	Steering	-	Pre-Ride	-	Make adjustments as needed. See Pre-Ride Checklist on page 47.
▶	Front suspension	-	Pre-Ride	-	
▶	Rear suspension	-	Pre-Ride	-	
	Tires	-	Pre-Ride	-	
▶	Brake fluid level	-	Pre-Ride	-	
▶	Brake lever travel	-	Pre-Ride	-	
	Brake system	-	Pre-Ride	-	
	Wheels/fasteners	-	Pre-Ride	-	
	Frame fasteners	-	Pre-Ride	-	
▶	Engine oil level	-	Pre-Ride	-	
▶ E	Air filter, pre-filter	-	Daily	-	Inspect; clean often; replace as needed
▶	Air box sediment tube	-	Daily	-	Drain deposits when visible
	Coolant (if applicable)	-	Daily	-	Check level daily, change coolant every 2 years
	Headlamp/tail lamp	-	Daily	-	Check operation; apply dielectric grease if replacing
▶ E	Air filter, main element	-	Weekly	-	Inspect; replace as needed
	Recoil housing (if equipped)	-	Weekly	-	Drain water as needed, check often if operating in wet conditions
▶ ■	Brake pad wear	10 H	Monthly	100 (160)	Inspect periodically
	Battery	20 H	Monthly	200 (320)	Check terminals; clean; test
▶	Front gearcase oil (if equipped)	25 H	Monthly	250 (400)	Inspect level; change yearly
▶	Rear gearcase oil (if equipped)	25 H	Monthly	250 (400)	Inspect level; change yearly
▶	Transmission oil	25 H	Monthly	250 (400)	Inspect level; change yearly
▶ E	Engine breather filter (if equipped)	25 H	Monthly	250 (400)	Inspect; clean if needed

▶ Perform these procedures more often for vehicles subjected to severe use.

E Emission-Related Service

■ Have an authorized Polaris dealer perform these services.

MAINTENANCE AND LUBRICATION

Periodic Maintenance Chart

Item		Maintenance Interval (whichever comes first)			Remarks
		Hours	Calendar	Miles (Km)	
▶	General lubrication	50 H	3 M	500 (800)	Lubricate all fittings, pivots, cables, etc.
	Carburetor float bowl	50 H	6 M	500 (800)	Drain bowl periodically and prior to storage
■ E	Throttle Cable/ ETC Switch	50 H	6 M	500 (800)	Inspect; adjust; lubricate; replace if necessary
■ E	Choke cable	50 H	6 M	500 (800)	Inspect; adjust; lubricate; replace if necessary
E	Carburetor air intake ducts/ flange	50 H	6 M	500 (800)	Inspect ducts for proper sealing/air leaks
	Drive belt	50 H	6 M	500 (800)	Inspect; adjust; replace as needed
	Cooling system (if applicable)	50 H	6 M	1000 (1600)	Inspect coolant strength seasonally; pressure test system yearly
▶	Engine oil change	100 H	6 M	1000 (1600)	Perform a break-in oil change at one month
▶	Oil filter change	100 H	6 M	1000 (1600)	Replace with oil change
■ E	Valve clearance	100 H	12 M	1000 (1600)	Inspect; adjust
■ E	Fuel system/filter	100 H	12 M	1000 (1600)	Check for leaks at tank cap, lines, fuel valve, filter, pump, carburetor; replace lines every two years
▶	Radiator (if applicable)	100 H	12 M	1000 (1600)	Inspect; clean external surfaces
▶	Cooling hoses (if applicable)	100 H	12 M	1000 (1600)	Inspect for leaks
▶	Engine mounts	100 H	12 M	1000 (1600)	Inspect
	Exhaust muffler/ pipe	100 H	12 M	1000 (1600)	Inspect
■ E	Spark plug	100 H	12 M	1000 (1600)	Inspect; replace as needed
■	Ignition Timing	100 H	12 M	1000 (1600)	Inspect

▶ Perform these procedures more often for vehicles subjected to severe use.

E Emission-Related Service

■ Have an authorized Polaris dealer perform these services.

MAINTENANCE AND LUBRICATION

Periodic Maintenance Chart

	Item	Maintenance Interval (whichever comes first)			Remarks
		Hours	Calendar	Miles (Km)	
▶	Wiring	100 H	12 M	1000 (1600)	Inspect for wear, routing, security; apply dielectric grease to connectors subjected to water, mud, etc.
■	Clutches (drive and driven)	100 H	12 M	1000 (1600)	Inspect; clean; replace worn parts
■	Front wheel bearings	100 H	12 M	1000 (1600)	Inspect; replace as needed
■	Brake fluid	200 H	24 M	2000 (3200)	Change every two years
	Spark arrestor	300 H	36 M	3000 (4800)	Clean out
	Idle speed	-			Adjust as needed
■	Toe adjustment	-			Inspect periodically; adjust when parts are replaced
	Headlight aim	-			Adjust as needed

▶ Perform these procedures more often for vehicles subjected to severe use.

E Emission-Related Service

■ Have an authorized Polaris dealer perform these services.

MAINTENANCE AND LUBRICATION

Lubrication Guide

Check and lubricate all components at the intervals outlined in the Periodic Maintenance Chart beginning on page 65. Items not listed in the chart should be lubricated at the General Lubrication interval.

Item	Lube	Method
Engine Oil	PS-4 0W50	See page 70.
Brakes	DOT 3 fluid only	See page 39.
Transmission	Premium AGL Synthetic Gearcase Lube	See page 74.
Rear Gearcase	Premium ATV Angle Drive Fluid	See page 75.
(1) Front A-Arms	●Grease	Inspect; tighten fasteners; grease (also after washing ATV or driving in water)

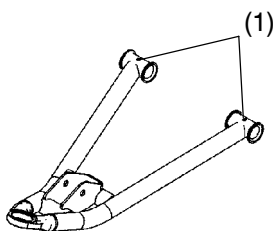
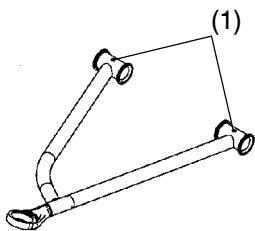

MAINTENANCE AND LUBRICATION

Engine Oil

Always check and change the engine oil at the intervals outlined in the Periodic Maintenance Chart beginning on page 65. Always change the oil filter whenever changing oil.

Performance Synthetic 4-Stroke (PS-4) Oil

Polaris recommends the use of Performance Synthetic 4-Stroke (PS-4) 0W50 oil for this engine. PS-4 is a fully synthetic, high performance, multi-viscosity oil designed to provide the ultimate in lubrication performance and protection. See page 103 for the part numbers of Polaris products.

Oil may need to be changed more frequently if Polaris oil is not used. Always use 0W50 oil. Follow the manufacturer's recommendations for ambient temperature operation.

CAUTION

Mixing brands or using a non-recommended oil may cause serious engine damage. Always use the recommended oil. Never substitute or mix oil brands.

MAINTENANCE AND LUBRICATION

Engine Oil Check

Maintain the oil level at the center of the sight glass. Do not overfill.

1. Position the vehicle on a level surface.
2. View the oil level through the sight glass (A) on the right side of the vehicle.

NOTE: A rising oil level between checks in cool weather driving can indicate contaminants such as gas or moisture collecting in the crankcase. If the oil level rises to the top of the sight glass, change the oil immediately.

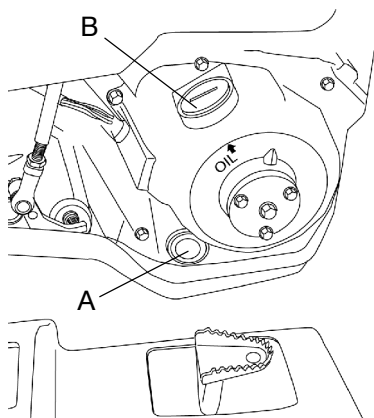

3. Remove the fill plug (B) and add the recommended oil as needed.
4. Reinstall the fill plug.

MAINTENANCE AND LUBRICATION

Oil and Filter Change

CAUTION

If the ATV is left without oil in the system for extended periods, the oil pump may lose its prime, which could result in engine damage. Always replace the oil and filter within a few hours of draining the oil. Do not allow the vehicle to be without oil overnight.

1. Obtain the correct oil filter and an adequate supply of oil so the oil and filter change can be completed without interruption.
2. Position the vehicle on a level surface.
3. Clean the area around the drain plug on the bottom of the engine crankcase.
4. Run the engine for two to three minutes until warm. Stop the engine.

CAUTION

Hot oil can cause serious burns to skin. Do not allow hot oil to come into contact with skin.

5. Place a drain pan beneath the engine crankcase and remove the drain plug. Allow the oil to drain completely.
6. Install a new sealing washer on the drain plug.

NOTE: The sealing surfaces on the drain plug and crankcase should be clean and free of burrs, nicks or scratches.

MAINTENANCE AND LUBRICATION

Oil and Filter Change

7. Reinstall the drain plug.
Torque to 11 ft. lbs. (15 Nm).
8. Place shop towels beneath the oil filter. Using an oil filter wrench, turn the filter counterclockwise to remove.
9. Using a clean, dry cloth, clean the filter sealing surface on the crankcase.
10. Lubricate the gasket on the new filter with a film of engine oil. Check to make sure the gasket is in good condition.
11. Install the new filter and turn by hand until the filter gasket contacts the sealing surface, then turn an additional 1/2 turn.
12. Remove the oil fill plug and add the recommended oil. Refer to the specifications section beginning on page 100 for capacities. Do not overfill.
13. Reinstall the fill plug.
14. Start the engine and let it idle for one to two minutes.
15. Stop the engine and inspect for leaks.
16. Check the oil level and add oil as necessary to maintain the level at the center of the sight glass.
17. Dispose of used filter and oil properly.

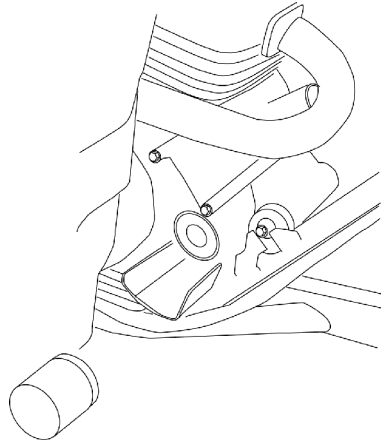

MAINTENANCE AND LUBRICATION

Gearcase Specification Chart

Gearcase	Lubricant	Capacity	Drain/Check Plug Torque	Fill Plug Torque
Transmission	Premium AGL Synthetic Gearcase Lubricant	18.6 oz. (550 ml)	18 ft. lbs. (24 Nm)	N/A
Rear Gearcase	Premium ATV Angle Drive Fluid	4 oz. (120 ml)	18 ft. lbs. (24 Nm)	25 ft. lbs. (34 Nm)

Transmission Oil

Always check and change the transmission oil at the intervals outlined in the Periodic Maintenance Chart beginning on page 65. Maintain the oil level between 1/4 and 3/4 on the sight glass. We recommend the use of Premium AGL Synthetic Gearcase Lubricant. Refer to the gearcase specifications chart on page 74. See page 103 for the part numbers of Polaris products.

Oil Check

1. Position the vehicle on a level surface.
2. View the oil level through the sight glass (A).
3. Remove the fill plug (B) and add the recommended oil as needed.
4. Reinstall the fill plug.

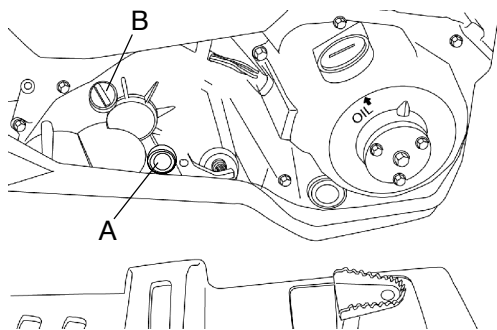

Oil Change

The transmission drain plug is located on the bottom of the vehicle near the center.

1. Remove the fill plug.
2. Remove the transmission drain plug. Drain the oil into an appropriate container. Discard used oil properly.
3. Clean and reinstall the drain plug. Torque to specification.
4. Add the recommended fluid.
5. Reinstall the fill plug.
6. Check for leaks.

MAINTENANCE AND LUBRICATION

Rear Gearcase Oil

Always check and change the rear gearcase oil at the intervals outlined in the Periodic Maintenance Chart beginning on page 65. Maintain the oil level at the bottom of the check plug hole. We recommend the use of Polaris Premium ATV Angle Drive Fluid. Refer to the gearcase specifications chart on page 74. See page 103 for the part numbers of Polaris products.

Oil Check

1. Position the vehicle on a level surface.
2. Remove the check plug (A) and view the oil level.
3. Remove the fill plug (B). Add the recommended oil as needed.
4. Reinstall the fill plug. Torque to specification.
5. Reinstall the check plug. Torque to specification.
6. Check for leaks.

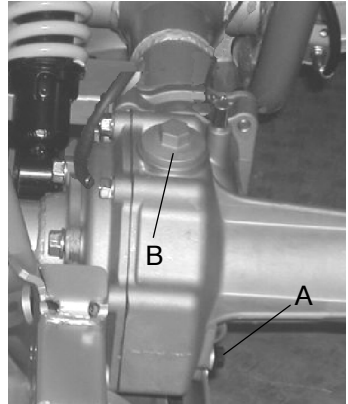

Oil Change

1. Remove the skid plate.
2. Remove the drain plug. Drain the oil into an appropriate container. Discard used oil properly.
3. Clean and reinstall the drain plug with a new sealing washer. Torque to specification.
4. Remove the fill plug and add the recommended gearcase oil.
5. Reinstall the fill plug. Torque to specification.
6. Check for leaks.
7. Reinstall the skid plate.

MAINTENANCE AND LUBRICATION

Lights

WARNING

Poor lighting while driving can result in severe injury or death. Headlight and taillight lenses become dirty during normal operation. Wash the headlights frequently to maintain lighting quality.

Hot components can cause serious burns to skin. Do not service the headlamps until they've cooled sufficiently.

Headlight Lamp Replacement

To access the assembly from the front, remove the front cover and unplug the wiring harness. Remove the headlight assembly from the vehicle.

To access the headlight assembly without removing the front cover, reach up under the front cab.

1. Remove the rubber cover (A) from the back of the headlight.
2. Rotate the socket (B) counterclockwise and pull it away from the headlight assembly.
3. Remove the headlamp.
4. Install the new headlamp.
5. Reinstall all components.

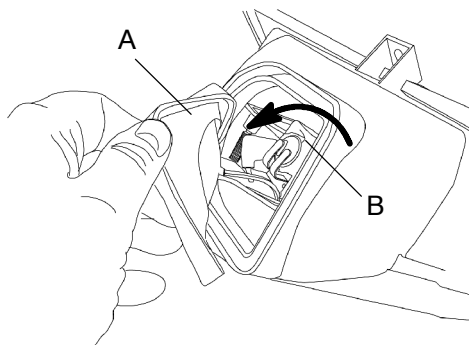

MAINTENANCE AND LUBRICATION

Lights

Taillight/Brakelight Lamp Replacement

If the taillight/brakelight does not work the lamp may need to be replaced.

1. Remove the taillight lens cover mounting screws (A).
2. Remove the lens cover and set aside for reassembly.
3. Remove the lamp (B).
4. Apply dielectric grease to the socket and install a new lamp.
5. Test the taillight/brakelight for proper operation.
6. Reinstall the lens cover.

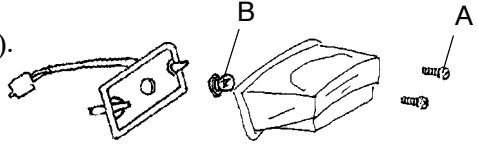

MAINTENANCE AND LUBRICATION

Spark Plugs

Refer to the specifications section beginning on page 100 for spark plug and gap specifications.

CAUTION

Using non-recommended spark plugs can result in serious engine damage. Always use Polaris-recommended spark plugs.

Spark plug condition is indicative of engine operation. The spark plug firing end condition should be read after the engine has been warmed up and the vehicle has been driven at higher speeds. Immediately check the spark plug for correct color.

⚠ WARNING

A hot exhaust system and engine can cause serious burns. Wear protective gloves when removing a spark plug for inspection.

1. Normal

The normal insulator tip is gray, tan or light brown. There will be few combustion deposits. The electrodes are not burned or eroded. This indicates the proper type and heat range for the engine and the service.

NOTE: The tip should not be white. A white insulator tip indicates overheating, caused by use of an improper spark plug or incorrect carburetion adjustments.

2. Wet Fouled

The wet fouled insulator tip is black. A damp oil film covers the firing end. There may be a carbon layer over the entire nose. Generally, the electrodes are not worn. General causes of fouling are excessive oil, use of non-recommended injection oil, improper use of the choke, or incorrect carburetion adjustments.

Spark Plug Removal and Replacement

1. Remove the spark plug cap (A).
2. Using the special wrench provided in the tool pouch, rotate the spark plug counterclockwise to remove.
3. Reverse the procedure for spark plug installation. Torque to 14 ft. lbs. (19 Nm).

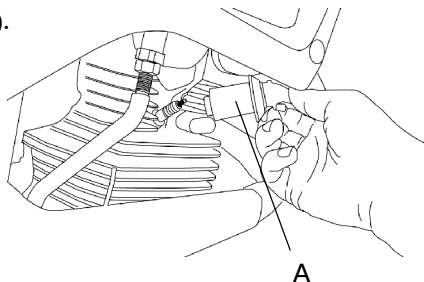

MAINTENANCE AND LUBRICATION

Vehicle Immersion

CAUTION

If your vehicle becomes immersed, major engine damage can result if the machine is not thoroughly inspected. Take the vehicle to your dealer before starting the engine.

If it's impossible to take your ATV to a dealer before starting it, follow the steps outlined below.

1. Move the ATV to dry land or at the very least, to water below the footrests.
2. Check the airbox for any water and dry it if water is present.
3. Turn the fuel valve off.
4. Remove the spark plug.
5. Loosen the carburetor drain screw (A).
6. Turn the engine over several times using the electric start.
7. Dry the spark plug and reinstall, or replace it with a new plug.
8. Tighten the carburetor drain screw.
9. Turn the fuel valve on.
10. Attempt to start the engine. If necessary, repeat the drying procedure.
11. Take the ATV to your dealer for service as soon as possible, whether you succeed in starting it or not.

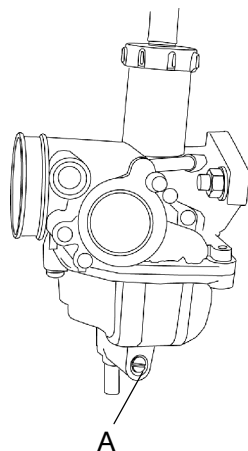

NOTE: If water has been ingested into the transmission, follow the procedure on page 81 for drying the CVT.

MAINTENANCE AND LUBRICATION

Spark Arrestor Clean-Out

WARNING

Do not perform clean-out immediately after the engine has been run, as the exhaust system becomes very hot. Serious burns could result from contact with the exhaust components.

Wear eye protection and gloves.

Never run the engine in an enclosed area. Exhaust contains poisonous carbon monoxide gas.

Failure to heed these warnings could result in serious injury or death.

Periodically clean the spark arrestor to remove accumulated carbon.

1. Remove the three screws (A) and remove the arrestor from the end of the muffler.
2. Use a non-synthetic brush to clean the arrestor screen. A synthetic brush may melt if components are warm. If necessary, blow debris from the screen with compressed air.
3. Inspect the screen for wear and damage. Replace if necessary.
4. Remove and inspect the gasket. Replace if worn or damaged.
5. Reinstall the gasket and arrestor.
6. Torque screws to 50 in. lbs. (5.6 Nm).

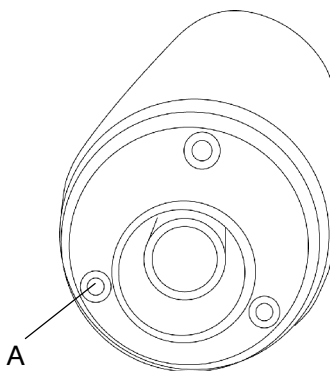

MAINTENANCE AND LUBRICATION

Constant Variable Transmission (CVT) System

WARNING

Failure to comply with the instructions in this warning can result in severe injury or death.

Do not modify any component of the CVT system. Doing so may reduce its strength so that a failure may occur at a high speed. The CVT system has been precision balanced. Any modification will cause the system to be out of balance, creating vibration and additional loads on components.

The CVT system rotates at high speeds, creating large amounts of force on clutch components. Extensive engineering and testing has been conducted to ensure the safety of this product. However, as the owner, you have the following responsibilities to make sure this system remains safe:

Always follow all recommended maintenance procedures. See your dealer as outlined in the owner's manual.

This CVT system is intended for use on Polaris products only. Do not install it in any other product.

Always make sure the CVT housing is securely in place during operation.

CVT Drying

There may be some instances when water is accidentally ingested into the CVT system. Use the following instructions to dry it out before operating. The drain plug is located on the bottom of the CVT cover.

1. Remove the drain plug. Allow the water to drain. Reinstall the drain plug.
2. Place the transmission in neutral.
3. Start the engine. Apply varying throttle for 10-15 seconds to expel the moisture and air-dry the belt and clutches. Do not hold the throttle wide open for more than 10 seconds.
4. Allow the engine RPM to settle to idle speed.
5. Test for belt slippage. If the belt slips, repeat the process.
6. Take the vehicle to your dealer for service as soon as possible.

MAINTENANCE AND LUBRICATION

Battery

⚠ WARNING

Improperly connecting or disconnecting battery cables can result in an explosion and cause serious injury or death. When removing the battery, always disconnect the negative (black) cable first. When reinstalling the battery, always connect the negative (black) cable last.

Battery Removal

1. Remove the seat.
2. Disconnect the battery hold-down strap.
3. Disconnect the black (negative) battery cable first.
4. Disconnect the red (positive) battery cable next.
5. Lift the battery out of the battery compartment.

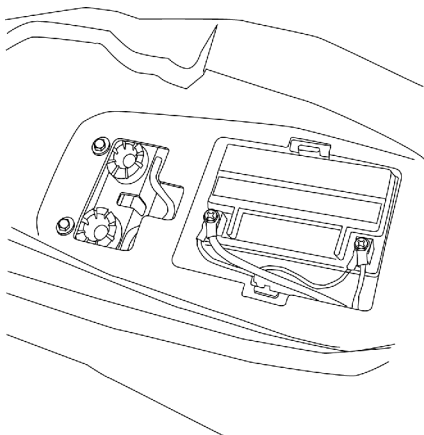

Battery Installation

When installing a new battery, make sure it's fully charged prior to its initial use. Using a new battery that has not been fully charged can damage the battery and result in a shorter life. It can also hinder vehicle performance. Follow the battery charging instructions on page 83 before installing the battery.

1. Ensure that the battery is fully charged.
2. Set the battery in the battery holder.
3. Connect and tighten the red (positive) cable first.
4. Connect and tighten the black (negative) cable last.
5. Attach the hold-down strap.
6. Verify that cables are properly routed.
7. Reinstall the seat.

MAINTENANCE AND LUBRICATION

Battery

Battery Storage

Whenever the vehicle is not used for a period of three months or more, remove the battery from the vehicle, ensure that it's fully charged, and store it out of the sun in a cool, dry place. Check battery voltage each month during storage and recharge as needed to maintain a full charge.

NOTE: Battery charge can be maintained by using a Polaris Battery Tender™ charger (PN 2871076) or by charging about once a month to make up for normal self-discharge. Battery Tender™ can be left connected during the storage period, and will automatically charge the battery if the voltage drops below a pre-determined point.

Battery Charging

The following battery charging instructions apply only to the installation of a sealed battery. Read all instructions before proceeding with the installation of this battery.

The sealed battery is already filled with electrolyte and has been sealed and *fully charged* at the factory. *Never pry the sealing strip off or add any other fluid to this battery.*

The single most important thing about maintaining a sealed battery is to keep it fully charged. Since the battery is sealed and the sealing strip cannot be removed, you must use a voltmeter or multimeter to measure DC voltage.

For a refresh charge, follow all instructions carefully.

1. Check the battery voltage with a voltmeter or multimeter. A fully charged battery will register 12.8 V or higher.
2. If the voltage is less than 12.8 volts, recharge the battery at 1.2 amps or less until the battery voltage is 12.8 or greater.

NOTE: When using an automatic charger, refer to the charger manufacturer's instructions for recharging. When using a constant current charger, use the following guidelines for recharging.

WARNING

An overheated battery may explode, causing severe injury or death. Always watch charging times carefully. Stop charging if the battery becomes very warm to the touch. Allow it to cool before resuming charging.

MAINTENANCE AND LUBRICATION

Battery

Battery Charging

NOTE: Always verify battery condition before and 1-2 hours after the end of charging.

State of Charge	Voltage	Action	Charge Time* <small>(Using constant current charger @ standard amps specified on top of battery)</small>
100%	12.8-13.0 volts	None, check at 3 mos. from date of manufacture	None required
75%-100%	12.5-12.8 volts	May need slight charge, if no charge given, check in 3 months	3-6 hours
50%-75%	12.0-12.5 volts	Needs charge	5-11 hours
25%-50%	11.5-12.0 volts	Needs charge	At least 13 hours, verify state of charge
0%-25%	11.5 volts or less	Needs charge with desulfating charger	At least 20 hours

MAINTENANCE AND LUBRICATION

Adjustments

Brakes (Front)

The front brakes are hydraulic disc brakes. These brakes are self-adjusting.

The following checks are recommended to keep the hydraulic brake system in good operating condition. Check more often if brakes are used heavily under normal operation.

⚠ WARNING

Never store or use a partial bottle of brake fluid. Brake fluid is hygroscopic, meaning it rapidly absorbs moisture from the air. The moisture causes the boiling temperature of the brake fluid to drop, which can lead to early brake fade and the possibility of accident or severe injury. After opening a bottle of brake fluid, always discard any unused portion.

⚠ WARNING

An over-full master cylinder may cause brake drag or brake lock-up, which could result in serious injury or death. Maintain brake fluid at the recommended level. Do not overfill.

1. Always keep brake fluid at an adequate level (see page 39).

NOTE: Under normal operation, the diaphragm extends into the reservoir as fluid level drops. If the fluid level is low and the diaphragm is not extended, a leak is likely and the diaphragm should be replaced. Always fill the reservoir as needed whenever the cover is loosened or removed to ensure proper diaphragm operation. Use Polaris DOT 3 brake fluid. Do not overfill.

2. Check the brake system for fluid leaks.
3. Check the brakes for excessive travel or spongy feel.
4. Check the friction pads for wear, damage and looseness.
5. Check the security and surface condition of the disc.

NOTE: Change the brake pads when they're worn to $3/64"$ (.1 cm).

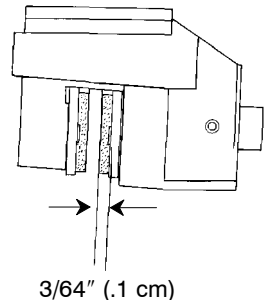

MAINTENANCE AND LUBRICATION

Adjustments

Brakes (Rear)

Periodically measure the freeplay of the rear brakes. To adjust rear brake freeplay, turn the adjuster nuts (A) at the rear brake drum.

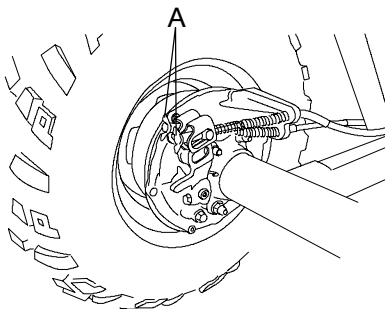
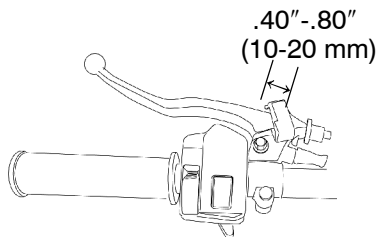

Brake Lever Travel (Rear)

Service the brakes when brake lever travel reaches 2 1/2" (65 mm). Always service the brakes when there is no longer sufficient stopping ability at the specified lever travel setting.

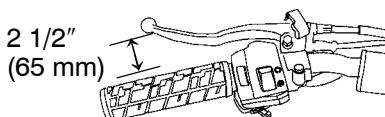

MAINTENANCE AND LUBRICATION

Adjustments

WARNING

Severe injury or death can result from improper toe alignment and adjustment. Do not attempt to adjust tie rod alignment. All tie rod adjustments should be performed by an authorized Polaris dealer.

Toe Alignment

Use the following procedure to check the toe alignment of the vehicle. The recommended toe alignment is $1/8'' - 1/4''$ (3-6 mm) toe out.

1. Set the handlebars in a straight-ahead position.

NOTE: The steering frog can be used as an indicator of whether the handlebars are straight. The frog should always point straight back from the steering post.

2. Place stands (A) in front of the vehicle, perpendicular to the rear tires. See illustration.
3. Tie an elastic string around the stands, making sure the string just touches the side surface of the rear tires on each side of the vehicle and goes around the stands in front of the vehicle (B).
4. Measure the distance from the string to the rim at the front and rear of the front rim (C). Rear measurement should be $1/16'' - 1/8''$ (2-3 mm) more than the front measurement.

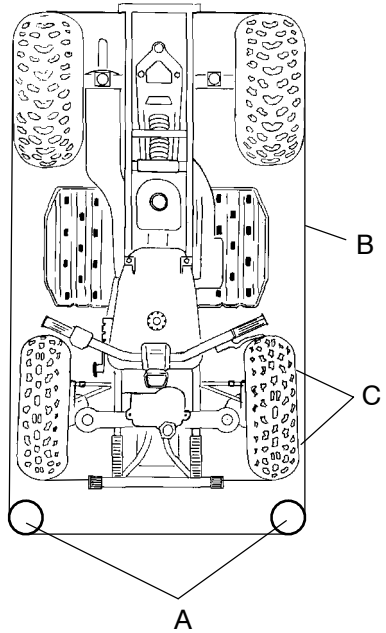

NOTE: If you discover improper alignment, see your Polaris dealer for service.

MAINTENANCE AND LUBRICATION

Adjustments

Steering Assembly

The steering assembly of the ATV should be checked periodically for loose nuts and bolts. If loose nuts and bolts are found, see your Polaris dealer for service before operating the vehicle.

Camber and Caster

The camber and caster are non-adjustable.

Rear Spring

The rear shock absorber spring is adjusted by rotating the adjuster (A) either clockwise or counterclockwise to increase or decrease spring tension.

NOTE: Accessory springs are available through your Polaris dealer.

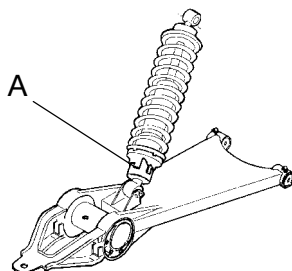

MAINTENANCE AND LUBRICATION

Adjustments

WARNING

Improper adjustment of the handlebars or incorrect torquing of the adjuster block tightening bolts can cause limited steering or loosening of the handlebars, resulting in loss of control and possible serious personal injury or death. Follow the adjustment procedures exactly, or see your Polaris dealer for service.

Handlebars

The handlebars can be adjusted for rider preference.

1. Remove the handlebar cover.
2. *Loosen* (do not remove) the four handlebar bolts.
3. Adjust the handlebar to the desired height. Be sure the handlebars do not contact the gas tank or any other part of the machine when turned fully to the left or right.
4. Torque the front two bolts (A) to 10-12 ft. lbs. (14-17 Nm), then torque the rear two bolts (B). A gap of up to 1/8" (3 mm) will remain at the rear bolts.

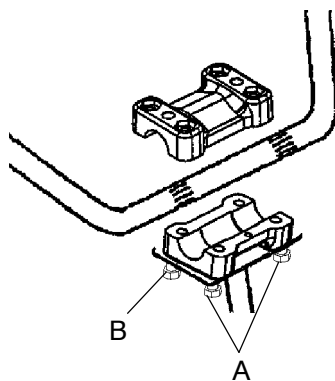

MAINTENANCE AND LUBRICATION

Adjustments

Carburetor

IMPORTANT: Your Polaris ATV is calibrated at the factory for optimal performance at altitudes ranging from zero to 6,000 feet (1800 m) and temperatures of +40 degrees F. (4 degrees C.) or higher. Above 6000 feet (1800 m) the engine air/fuel mixture becomes overly rich and the engine loses approximately 3% of its power for each 1000-foot (304.8 m) increase in elevation. Although this power cannot be regained, adjustments to the carburetor and drive system can be made to allow more efficient operation. Optional jets, available from your Polaris dealer, are required for operation above 6,000 feet and temperatures below +40 degrees F. (4 degrees C.)

NOTE: Continuous operation of the engine without proper jetting when required can cause poor performance, overheating or engine damage. See your Polaris dealer for more information about jetting the ATV for conditions in your area.

If the engine idle speed is not satisfactory, and all other conditions are favorable, the carburetor can be adjusted.

1. Start the engine.
2. Lock the parking brake.
3. Allow the engine to run for approximately five minutes.
4. Adjust the carburetor idle screw either in or out until the desired idle RPM is reached. Turning the screw in (clockwise) will raise RPM. Turning the screw out (counterclockwise) will lower RPM.

MAINTENANCE AND LUBRICATION

Adjustments

Throttle Cable Freeplay

The throttle cable adjuster is located at the right handlebar.

1. Slide the boots (A) off the inline cable adjuster sleeve (B). Loosen the adjuster locknut (C).
2. Turn the adjuster until 1/16" to 1/8" freeplay is achieved at the thumb lever.

NOTE: While adjusting freeplay, be sure to flip the throttle lever back and forth several times.

3. Tighten the locknut and slide the boots over the cable adjuster until they touch at the midpoint of the adjuster.

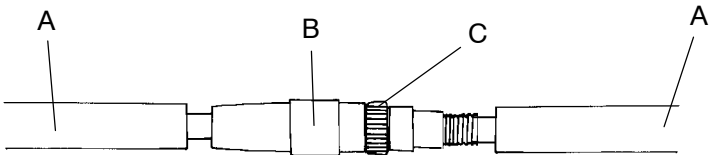

Side Panel Removal

1. Remove the seat.
2. Remove the six fasteners (A) securing the side panel to the vehicle.
3. Pull the side panel away from the vehicle.

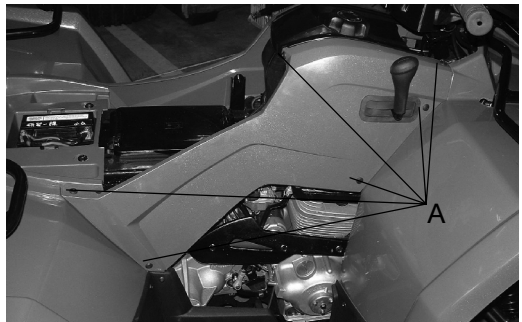

MAINTENANCE AND LUBRICATION

Adjustments

WARNING

Operating your ATV with worn tires, improperly inflated tires, non-standard tires or improperly installed tires will affect vehicle handling and could cause an accident resulting in serious injury or death.

Maintain proper tire pressure as described on the decal on your ATV and in the specifications section of the owner's manual beginning on page 100.

Always use original equipment size and type when replacing tires.

Make sure the wheels are installed properly.

Always replace tires when the tread depth measures 1/8" (.3 cm) or less.

Wheel Removal

1. Stop the engine.
2. Remove the key from the ignition.
3. Lock the parking brake.
4. Loosen the wheel nuts slightly.
5. Elevate the side of the vehicle by placing a suitable stand under the footrest frame.
6. Remove the wheel nuts and remove the wheel.

MAINTENANCE AND LUBRICATION

Adjustments

⚠ WARNING

Improperly installed wheels can adversely affect tire wear and vehicle handling, which can result in serious injury or death. Always ensure that all nuts are torqued to specification. Do not service axle nuts that have a cotter pin installed. See your Polaris dealer.

Wheel Installation

1. Position the vehicle on a level surface.
2. Lock the parking brake.
3. Place the wheel on the wheel hub with the valve stem toward the outside and rotation arrows on the tire pointing toward forward rotation.
4. Install the wheel nuts and finger tighten.
5. Lower the vehicle to the ground.
6. Torque the wheel nuts to specification.

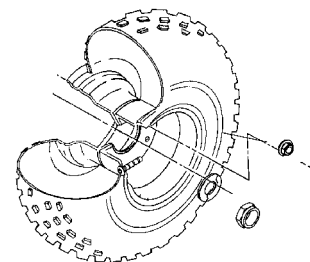

Wheel Nut Torque Specifications

Check the wheel nut torques occasionally and when they've been loosened for maintenance service.

Location	Specification
Front Wheel Nuts	27 ft. lbs. (37 Nm)
Rear Wheel Nuts	27 ft. lbs. (37 Nm)

MAINTENANCE AND LUBRICATION

Adjustments

Front Wheel Hub Tightening

Front wheel bearing tightness and spindle nut retention are critical component operations. All service must be performed by your authorized Polaris dealer.

Tire Tread Depth

Always replace tires when tread depth is worn to 1/8" (3 mm) or less. See illustration.

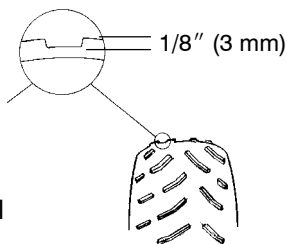

⚠ WARNING

Operating the vehicle with worn tires will increase the possibility of skidding, which could lead to loss of control and serious injury or death. Always replace tires when the tread depth measures 1/8" (3 mm) or less.

⚠ WARNING

Use of non-standard size or type of tires or improper tire inflation may adversely affect vehicle maneuverability and cause loss of control resulting in serious injury or death. Maintain proper tire pressure as outlined in this owner's manual. When replacing a tire always use original equipment size and type.

MAINTENANCE AND LUBRICATION

Adjustments

Air Filter Service

1. Remove the seat.
2. Release the clips and remove the air box cover (A).
3. Loosen the clamp and remove the filter.
4. Remove the pre-filter (B) from the main filter (C). Wash the pre-filter in soapy water, then rinse and let dry.
5. Reinstall the pre-filter over the main filter. (Replace the main filter if needed.)
6. Reinstall the filter into the air box and tighten the clamp. Do not over tighten the clamp, as filter damage could occur.

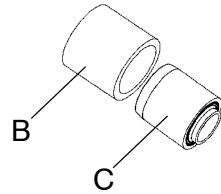
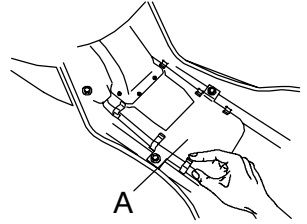

MAINTENANCE AND LUBRICATION

Cleaning and Storage

See page 103 for the part numbers of Polaris products.

Cleaning the ATV

Keeping your ATV clean will not only improve its appearance but it can also extend the life of various components. With a few precautions, your ATV can be cleaned much like an automobile.

Washing the ATV

The best and safest way to clean your ATV is with a garden hose and a pail of mild soap and water. Use a professional type washing mitten, cleaning the upper body first and the lower parts last. Rinse with water frequently and dry with a chamois to prevent water spots.

NOTE: If warning and safety labels are damaged, contact your Polaris dealer for free replacement.

Polaris does not recommend the use of a high pressure type car wash system for washing the ATV. If a high pressure system is used, exercise extreme care to avoid water damage to the wheel bearings, transmission seals, body panels, brakes and warning labels.

NOTE: Grease all zerk fittings immediately after washing, and allow the vehicle to run for a while to evaporate any water that may have entered the engine or exhaust system.

Waxing the ATV

Your ATV can be waxed with any non-abrasive automotive paste wax. Avoid the use of harsh cleaners since they can scratch the body finish.

CAUTION

Certain products, including insect repellants and chemicals, will damage plastic surfaces. Use caution when using these products near plastic surfaces.

MAINTENANCE AND LUBRICATION

Cleaning and Storage

Storage Tips

See page 103 for the part numbers of Polaris products.

CAUTION

Starting the engine during the storage period will disturb the protective film created by fogging and damage could occur. Never start the engine during the storage period.

Exterior

Make necessary repairs and then clean the ATV thoroughly with mild soap and warm water to remove all dirt and grime. Don't use harsh detergents or high pressure washers. Some detergents deteriorate rubber parts. Use dish soap type cleaners only. High pressure washers may force water past seals.

Fuel Stabilizer

Polaris Carbon Clean is a fuel stabilizer and fuel system dryer. It cleans the fuel system, the combustion chamber and the exhaust ports. It also prevents bacterial growth and promotes better starting after the storage period.

1. Fill the fuel tank with fuel and add Polaris Carbon Clean or Fuel Stabilizer. Follow the instructions on the container for the recommended amounts.
2. Start the engine and allow it to run for 15-20 minutes so the stabilizer can disperse through the fuel in the tank and carburetor.
3. Stop the engine.
4. Turn the fuel valve off.
5. Drain the carburetor bowl.

Oil and Filter

Warm the engine and change the oil and filter.

Air Filter / Air Box

Inspect and clean or replace the pre-cleaner and air filter. Clean the air box and drain the sediment tube.

MAINTENANCE AND LUBRICATION

Cleaning and Storage

Storage Tips

See page 103 for the part numbers of Polaris products.

Fluid Levels

Inspect fluid levels and change fluids if necessary.

- Transmission
- Brake Fluid

Engine Fogging

Use Polaris Engine Fogging Oil. Follow label directions carefully.

CAUTION

Starting the engine during the storage period will disturb the protective oil film, which can lead to engine damage. Never start the engine during the storage period.

Lubricate

Inspect all cables and lubricate with Polaris Cable Lubricant. Follow lubrication guidelines in the maintenance section of the service or owner's manual to completely grease and lubricate the entire vehicle with Polaris Premium All Season Grease.

Storage Area/Covers

1. Make sure tire pressure is at specification.
2. Using suitable supports under the frame, raise the vehicle slightly so that the tires are not touching the ground.
3. Be sure the storage area is well ventilated.
4. Cover the machine with an appropriate cover. Do not use plastic or coated materials, as they do not allow proper ventilation to prevent condensation, corrosion and oxidation.

MAINTENANCE AND LUBRICATION

Cleaning and Storage

Transporting an ATV

Follow these procedures when transporting an ATV.

1. Turn off the engine and remove the key to prevent loss during transporting.
2. Turn the fuel valve off.
3. Be sure the fuel cap, oil cap and seat are installed correctly and securely.
4. Always tie the *frame* of the ATV to the transporting unit securely using suitable straps or rope. The rack, bumper or handlebars do not offer enough support for tie-down while transporting the unit.
5. Place the transmission in gear and lock the parking brake.

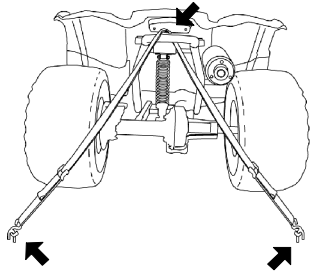
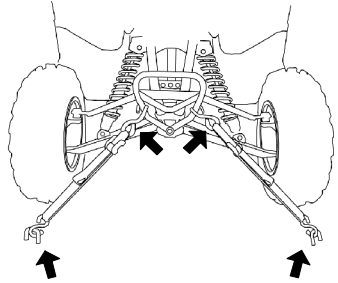

SPECIFICATIONS

<i>Capacities</i>	
Gross Vehicle Weight	765 lbs. (348 kg)
Dry Weight	425 lbs. (193 kg)
Fuel Capacity	2.75 gal. (10.4 l)
Engine Oil Capacity	41 oz. (1200 ml)
Transmission Oil	18.6 oz. (550 ml)
Rear Gearcase Oil	4 oz. (120 ml)
Front Rack	45 lbs. (20 kg)
Rear Rack	70 lbs. (32 kg)
Tongue Weight	30 lbs. (13.6 kg)(Rear rack weight and tongue weight not to exceed 30 lbs./13.6 kg)
Tow Capacity	300 lbs. (136 kg)
Turn Radius	65 in. (165 cm) unloaded
Ground Clearance	5.7 in. (14.5 cm)
Length	70 in. (178 cm)
Width	42 in. (106.7 cm)
Height	42 in. (106.7 cm)
Seat Height	32 in. (81.3 cm)
Wheel Base	45 in. (114.3 cm)
<i>Engine & Cooling</i>	
Engine Model Number / Type	4 Cycle, Single Cylinder
Lubrication	Wet Sump
Bore x Stroke	65 x 59
Displacement	196 cc
Compression Ratio	9.2:1 Full Stroke
Engine Cooling	Air cooled
Alternator Output (watts)	210w @5000 rpm
Carburetion	1 / 22 mm (VM Type)
Main Jet	108
Pilot Jet	35
Jet Needle	2MKNN-4 clip
Air Screw	1 Turn Out
Ignition	DC CDI
Timing	32° ± 2° @ 3000 RPM
Spark Plug Type / Gap	NGK CR6HSA / 0.6-0.7 mm

SPECIFICATIONS

<i>Drive System</i>	
Drive System Type	Constant Variable Transmission (CVT)
Shift Type	Side Lever F/N/R
Front Drive (ratio)	N/A
Front Tires	21 x 7-10 (4 psi)
Rear Tires	21 x 10-10 (3 psi)
<i>Suspension and Brakes</i>	
Front Suspension	Dual A-Arm w/7 in. (17.8 cm) travel
Rear Suspension	Mono-Shock Swing Arm w/6.5 in. (16.5 cm) travel
Shock Adjustment	CAM
Front Brake	Hydraulic Disc
Rear Brake	Mechanical Drum
Foot Brake	Mechanical Drum, Rear Brake
Park Brake	Mechanical, Rear
<i>Features</i>	
Headlight	Front Bumper, Hi/Lo 35W Halogen
Taillight	12V 5W
Brake Light	12V 21W
Battery	12V 12 AH
DC Plug-In (Rear)	Accessory
Electric Start	Standard
Windshield	Accessory
Neutral Indicator	Standard
Reverse Indicator	Standard
Tool Kit	Standard

SPECIFICATIONS

Jetting Chart

ALTITUDE Meters (Feet)	AMBIENT TEMPERATURE	
	Below 40° F (Below 5° C)	+40°F and above (+5°C and above)
0-1800 (0-6000)	108	108
1800-3700 (6000-12000)*	92.5	90

*Change to a #40 pilot jet if operating the ATV at these higher elevations.

Clutching Chart

Altitude Meters (Feet)	Roller Weight Grams Each
0-1800 (0-6000)	6 @ 14.5 grams
1800-3700 (6000-12000)	6 @ 11 grams

POLARIS PRODUCTS

Part No.	Description
Engine Lubricant	
2870791	Fogging Oil (12 oz. Aerosol)
2874865	Performance Synthetic 4-Stroke (PS-4) 0W 50 Oil (qt.)
2874866	Performance Synthetic 4-Stroke (PS-4) 0W 50 Oil (gal.)
Gearcase / Transmission Lubricants	
2873602	Premium AGL Synthetic Gearcase Lube (qt.)
2873603	Premium AGL Synthetic Gearcase Lube (gal.)
2871653	Premium ATV Angle Drive Fluid (8 oz.)
2872276	Premium ATV Angle Drive Fluid (2.5 gal.)
2870465	Pump for Gallon Jug
Grease / Specialized Lubricants	
2871322	Premium All Season Grease (3 oz. cartridge)
2871423	Premium All Season Grease (14 oz. cartridge)
2871460	Starter Drive Grease
2871515	Premium U-Joint Lube (3 oz.)
2871551	Premium U-Joint Lube (14 oz.)
2871312	Grease Gun Kit
2871329	Dielectric Grease (Nyogel™)
Additives / Miscellaneous	
2872889	Brake and Clutch Cleaner
2871326	Carbon Clean Plus (12 oz.)
2870652	Fuel Stabilizer (16 oz.)
2870990	DOT3 Brake Fluid
2872893	Engine Degreaser
2871956	LOCTITE 565 Thread Sealant

TROUBLESHOOTING

Contact your Polaris dealer for service if you're unable to identify solutions using the following charts.

Engine Doesn't Turn Over

Possible Cause	Solution
Tripped circuit breaker	Reset the breaker
Low battery voltage	Recharge battery to 12.8 VDC
Loose battery connections	Check all connections and tighten
Loose solenoid connections	Check all connections and tighten

Engine Turns Over, Fails to Start

Possible Cause	Solution
Out of fuel	Turn fuel valve to reserve, refuel
Clogged fuel valve or filter	Inspect and clean or replace
Water is present in fuel	Drain the fuel system and refuel
Fuel valve is turned off	Turn the fuel valve on
Old or non-recommended fuel	Replace with new fuel
Fouled or defective spark plug(s)	Inspect plug(s), replace if necessary
No spark to spark plug	Inspect plug(s), verify stop switch is on
Crankcase filled with water or fuel	Immediately see your Polaris dealer
Overuse of choke	Inspect, clean and/or replace spark plugs
Clogged fuel filter	Replace the filter
Low battery voltage	Recharge battery to 12.8 VDC
Mechanical failure	See your Polaris dealer

Engine Pings or Knocks

Possible Cause	Solution
Poor quality or low octane fuel	Replace with recommended fuel
Incorrect ignition timing	See your Polaris dealer
Incorrect spark plug gap or heat range	Set gap to specs or replace plugs

TROUBLESHOOTING

Engine Backfires

Possible Cause	Solution
Weak spark from spark plugs	Inspect, clean and/or replace spark plugs
Incorrect spark plug gap or heat range	Set gap to specs or replace plugs
Old or non-recommended fuel	Replace with new fuel
Incorrectly installed spark plug wires	See your Polaris dealer
Incorrect ignition timing	See your Polaris dealer
Mechanical failure	See your Polaris dealer

Engine Runs Irregularly, Stalls or Misfires

Possible Weak Spark Cause	Solution
Fouled or defective spark plugs	Inspect, clean and/or replace spark plugs
Worn or defective spark plug wires	See your Polaris dealer
Incorrect spark plug gap or heat range	Set gap to specs or replace plugs
Loose ignition connections	Check all connections and tighten
Water present in fuel	Replace with new fuel
Low battery voltage	Recharge battery to 12.8 VDC
Kinked or plugged fuel vent line	Inspect and replace
Incorrect fuel	Replace with recommended fuel
Clogged air filter	Inspect and clean or replace
Electronic Throttle Control malfunction	See your Polaris dealer
Other mechanical failure	See your Polaris dealer
Possible Lean Fuel Mixture Cause	Solution
Low or contaminated fuel	Add or change fuel, clean the fuel system
Low octane fuel	Replace with recommended fuel
Clogged fuel filter	Replace filter
Incorrect jetting	See your Polaris dealer
Possible Rich Fuel Mixture Cause	Solution
Overuse of choke	Inspect, clean and/or replace spark plugs
Fuel is very high octane	Replace with lower octane fuel
Incorrect jetting	See your Polaris dealer

TROUBLESHOOTING

Engine Stops or Loses Power

Possible Cause	Solution
Out of fuel	Turn fuel valve to reserve, refuel
Kinked or plugged fuel vent line	Inspect and replace
Water present in fuel	Replace with new fuel
Overuse of choke	Inspect, clean and/or replace spark plugs
Fouled or defective spark plugs	Inspect, clean and/or replace spark plugs
Worn or defective spark plug wires	See your Polaris dealer
Incorrect spark plug gap or heat range	Set gap to specs or replace plugs
Loose ignition connections	Check all connections and tighten
Low battery voltage	Recharge battery to 12.8 VDC
Incorrect fuel	Replace with recommended fuel
Clogged air filter	Inspect and clean or replace
Reverse speed limiter malfunction	See your Polaris dealer
Electronic throttle control malfunction	See your Polaris dealer
Other mechanical failure	See your Polaris dealer
Overheated engine	Clean radiator screen and core if equipped Clean engine exterior See your Polaris dealer

WARRANTY

LIMITED WARRANTY

Polaris Sales Inc., 2100 Highway 55, Medina, MN 55340, gives a SIX MONTH LIMITED WARRANTY on all components of the Polaris All Terrain Vehicle (ATV) against defects in material or workmanship. Polaris also gives a one year limited warranty on the final drive chain for failure due to defects. This warranty covers the parts and labor charges for repair or replacement of defective parts which are covered by this warranty. This warranty begins on the date of purchase. This warranty is transferrable to another consumer during the warranty period through a Polaris dealer.

REGISTRATION

At the time of sale, the Warranty Registration Form must be completed by your dealer and submitted to Polaris within ten days. Upon receipt of this registration, Polaris will record the registration for warranty. No verification of registration will be sent to the purchaser as the copy of the Warranty Registration Form will be the warranty entitlement. If you have not signed the original registration and received the "customer copy", please contact your dealer immediately. **NO WARRANTY COVERAGE WILL BE ALLOWED UNLESS YOUR ATV IS REGISTERED WITH POLARIS.**

Initial dealer preparation and set-up of your ATV is very important in ensuring trouble-free operation. Purchasing a machine in the crate or without proper dealer set-up will void your warranty coverage.

WARRANTY COVERAGE AND EXCLUSIONS:

LIMITATIONS OF WARRANTIES AND REMEDIES

The Polaris limited warranty excludes any failures that are not caused by a defect in material or workmanship. This warranty does not cover accidental damage, normal wear and tear, abuse or improper handling. This warranty also does not cover any ATV that has been altered structurally, modified, neglected, improperly maintained, used for racing, or used for purposes other than for which it was manufactured, or for any damages which occur during trailer transit or as a result of unauthorized service or the use of unauthorized parts. In addition, this warranty does not cover physical damage to paint or finish, stress cracks, tearing or puncturing of upholstery material, corrosion, or defects in parts, components or the ATV due to fire, explosions or any other cause beyond Polaris' control.

This warranty does not cover the use of unauthorized lubricants, chemicals, or fuels that are not compatible with the ATV. The exclusive remedy for breach of this warranty shall be, at Polaris' exclusive option, repair or replacement of any defective materials, or components or products. **THE REMEDIES SET FORTH IN THIS WARRANTY ARE THE ONLY REMEDIES AVAILABLE TO ANY PERSON FOR BREACH OF THIS WARRANTY. POLARIS SHALL HAVE NO LIABILITY TO ANY PERSON FOR INCIDENTAL, CONSEQUENTIAL OR SPECIAL DAMAGES OF ANY DESCRIPTION, WHETHER ARISING OUT OF EXPRESS OR IMPLIED WARRANTY OR ANY OTHER CONTRACT, NEGLIGENCE, OR OTHER TORT OR OTHERWISE.** Some states do not permit the exclusion or limitation of incidental or consequential damages or implied warranties, so the above limitations or exclusions may not apply to you if inconsistent with controlling state law.

WARRANTY

WARRANTY COVERAGE AND EXCLUSIONS:

LIMITATIONS OF WARRANTIES AND REMEDIES

ALL IMPLIED WARRANTIES (INCLUDING BUT NOT LIMITED TO THE IMPLIED WARRANTIES OF MERCHANTABILITY AND FITNESS FOR A PARTICULAR PURPOSE) ARE LIMITED IN DURATION TO THE ABOVE SIX MONTH WARRANTY PERIOD. POLARIS FURTHER DISCLAIMS ALL EXPRESS WARRANTIES NOT STATED IN THIS WARRANTY. Some states do not allow limitations on how long an implied warranty lasts, so the above limitation may not apply to you if inconsistent with controlling state law.

HOW TO OBTAIN WARRANTY SERVICE

If your ATV requires warranty service, you must take it to a Polaris dealer authorized to repair Polaris ATVs. When requesting warranty service you must present your copy of the Warranty Registration form to the dealer. (THE COST OF TRANSPORTATION TO AND FROM THE DEALER IS YOUR RESPONSIBILITY). Polaris suggests that you use your original selling dealer; however, you may use any Polaris Servicing Dealer to perform warranty service.

Please work with your dealer to resolve any warranty issues. Should your dealer require any additional assistance they will contact the appropriate personnel at Polaris.

This warranty gives you specific legal rights, and you may also have other rights which vary from state to state.

If any of the above terms are void because of state or federal law, all other warranty terms will remain in effect.

Engine Oil

1. Mixing oil brands or using non-recommended oil may cause engine damage. We recommend the use of Polaris engine oil.
2. Damage resulting from the use of non-recommended lubricants may not be covered by warranty.

SPARK ARRESTOR

Polaris warrants that the spark arrestor in this vehicle will meet the efficiency requirements of 43 CFR 8340.1(c) for at least 1000 hours when subjected to normal use and when maintenance and installation are in accordance with Polaris recommendations.

Exported Vehicles

EXCEPT WHERE SPECIFICALLY REQUIRED BY LAW, THERE IS NO WARRANTY OR SERVICE BULLETIN COVERAGE ON THIS VEHICLE IF IT IS SOLD OUTSIDE THE COUNTRY OF THE SELLING DEALER'S AUTHORIZED LOCATION.

This policy does not apply to vehicles that have received authorization for export from Polaris Industries. Dealers may not give authorization for export. You should consult an authorized dealer to determine this vehicle's warranty or service bulletin coverage if you have any questions.

This policy does not apply to vehicles registered to government officials or military personnel on assignment outside the country of the selling dealer's authorized location.

This policy does not apply to Safety Recalls.

How to Get Service

In the Country where your vehicle was purchased:

Warranty or Service Bulletin repairs must be done by an authorized Polaris dealer. If you move or are traveling within the country where your vehicle was purchased, Warranty or Service Bulletin repairs may be requested from any authorized Polaris dealer who sells the same line as your vehicle.

Outside the Country where your vehicle was purchased:

If you are traveling temporarily outside the country where your vehicle was purchased, you should take your vehicle to an authorized Polaris dealer. You must show the dealer photo identification from the country of the selling dealer's authorized location as proof of residence. Upon residence verification, the servicing dealer will be authorized to perform the warranty repair.

If You Move:

If you move to another country, be sure to contact Polaris Customer Assistance and the customs department of the destination country before you move. Vehicles importation rules vary considerably from country to country. You may be required to present documentation of your move to Polaris Industries in order to continue your warranty coverage. You may also be required to obtain documentation from Polaris Industries in order to register your vehicle in your new country.

How to Get Service

If Purchased From A Private Party:

If you purchase a Polaris product from a private citizen outside of the country in which the vehicle was originally purchased, all warranty coverage will be denied.

Notice

If your vehicle is registered outside of the country where it was purchased, and you have not followed the procedure set out above, your vehicle will no longer be eligible for warranty or service bulletin coverage of any kind. (Vehicles registered to Government officials or military personnel on assignment outside of the country where the vehicle was purchased will continue to be covered by the basic warranty.)

For questions call Polaris Customer Assistance:

United States: 1-763-417-8650

Canada: 1-204-925-7100

WARRANTY

U.S.A. EPA Emissions Limited Warranty

This All Terrain Vehicle (ATV) or Off Road Utility Vehicle (ORUV) emissions limited warranty is in addition to the Polaris standard limited warranty for this vehicle.

Polaris warrants that this vehicle is; (1) designed, built, and equipped to conform at the time of initial sale with the requirements of 40 CFR 1051 and, (2) free from defects in materials and workmanship that may keep it from meeting these requirements.

The emissions warranty period for this vehicle begins on the date the vehicle is delivered to the original retail purchaser and ends 30 months (2.5 years) after that date, or after 5000 km (3100 miles), whichever comes first.

This emission-related warranty covers components whose failure would increase an engine's emissions, including electronic controls, fuel injection, exhaust-gas recirculation, aftertreatment, or any other system utilized in this vehicle to control emissions. Replacing or repairing other components not covered by this emissions warranty or the standard warranty is the responsibility of the owner; including the parts, labor and other costs associated with recommended maintenance.

The exclusive remedy for breach of this limited warranty shall be, at the exclusive option of Polaris, repair or replacement of any defective materials, components or products. THE REMEDIES SET FORTH IN THIS LIMITED WARRANTY ARE THE ONLY REMEDIES AVAILABLE TO ANY PERSON FOR BREACH OF THIS WARRANTY. POLARIS SHALL HAVE NO LIABILITY TO ANY PERSON FOR INCIDENTAL, CONSEQUENTIAL OR SPECIAL DAMAGES OF ANY DESCRIPTION, WHETHER ARISING OUT OF EXPRESS OR IMPLIED WARRANTY OR ANY OTHER CONTRACT, NEGLIGENCE OR OTHER TORT OR OTHERWISE.

ALL IMPLIED WARRANTIES (INCLUDING BUT NOT LIMITED TO ANY IMPLIED WARRANTIES OF MERCHANTABILITY AND FITNESS FOR A PARTICULAR PURPOSE) ARE LIMITED IN DURATION TO THE WARRANTY PERIOD DESCRIBED HEREIN. POLARIS DISCLAIMS ALL EXPRESS WARRANTIES NOT STATED IN THIS WARRANTY. Some states do not allow limitations on how long an implied warranty lasts, so the above limitation may not apply if it is inconsistent with the controlling state law.

This limited warranty excludes failures not caused by a defect in material or workmanship. This limited warranty does not cover damage due to accidents, abuse or improper handling, maintenance or use. This limited warranty also does not cover any engine that has been structurally altered, or any engine that has been used in racing competition. This limited warranty also does not cover physical damage, corrosion or defects caused by fire, explosions or other similar causes beyond the control of Polaris.

If you have any questions regarding your warranty rights and responsibilities, you should contact the Polaris Warranty Department at 1-763-417-8650.

MAINTENANCE LOG

Use the following chart to record periodic maintenance.

DATE	MILES (KM)	TECHNICIAN	SERVICE PERFORMED / COMMENTS

MAINTENANCE LOG

DATE	MILES (KM)	TECHNICIAN	SERVICE PERFORMED / COMMENTS

INDEX

A

Adjustments	85-95
Age Restrictions	6
Air Filter	95

B

Battery	82-84
Battery Charging	83-84
Battery Installation	82
Battery Removal	82
Battery Storage	83
Brake, Foot	41
Brake Lever (Left)	40
Brake Lever (Right)	40
Brake Lever Travel	86
Brakes	39-41
Brakes (Front)	85
Brakes (Rear)	86
Break-In Period	46

C

Camber and Caster	88
Carburetor	90
Choke	43
Cleaning and Storage	96-99
Cleaning the ATV	96
Clutching Chart	102
Cold Weather Operation	48
Constant Variable Transmission	81
Crankcase Emission Control System	64
CVT	81
CVT Drying	81

D

Driving Downhill	56
Driving in Reverse	62
Driving on Slippery Surfaces	54
Driving Over Obstacles	61
Driving Procedures	50
Driving Safely	50-63
Driving Through Water	60
Driving Uphill	55

E

Electrical Switches	36-37
Emission Control Systems	64
Emissions Warranty	110
Engine Fogging	98

E

Equipment Modifications	11
Exhaust Emission Control System	64

F

Fogging	98
Foot Brake	41
Front Wheel Hub Tightening	94
Fuel Filter	43
Fuel Safety	35
Fuel Stabilizer	97
Fuel Tank	43
Fuel Valve	43

G

Gear Selector	44
Gearcase Oil, Rear	75
Gearcase Specification Chart	74

H

Handlebars	89
Hauling Cargo	52-53
Headlight Lamp Replacement	76
Helmet	34

I

Indicator Lights	37
------------------	----

J

Jetting Chart	102
---------------	-----

K

K-Turn	58-59
Key Switch	36
Kick-Start Lever	45

L

Light Switch	36
Lights	76-77
Lubrication Guide	69

M

Main Switch	36
Maintenance Log	111-113
Making Turns	51
Master Cylinder	39

INDEX

N

Noise Emission Control System . . . 64

O

Oil Change 72-73
Oil Check 71
Oil, Engine 70
Operator Safety 6-29
Override Switch 37

P

Parking Brake 42
Parking on an Incline 63
Periodic Maintenance Chart 65-68
Polaris Products 103
Pre-Ride Inspection 47

R

Rear Gearcase Oil 75
Rear Spring 88

S

Safe Riding Gear 34
Safety Decals and Locations 30-33
Safety Training 6
Severe Use 65
Side Panel Removal 91
Sidehilling 57
Spark Arrestor Clean-Out 80
Spark Plugs 78
Specifications 100-102

S

Start Button 36
Starting the Engine 48-49
Steering Assembly 88
Stop Switch 36
Storage Tips 97-98

T

Taillight/Brakelight
Lamp Replacement 77
Throttle Cable Freeplay 91
Throttle Lever 38
Tire Tread Depth 94
Toe Alignment 87
Towing 52-53
Transmission Gear Selector 44
Transmission Oil 74
Transporting an ATV 99
Troubleshooting 104-106
Turning Around on a Hill 58-59

V

Vehicle Identification Numbers 5
Vehicle Immersion 79

W

Warranty 107-110
Washing the ATV 96
Waxing the ATV 96
Wheel Installation 93
Wheel Nut Torque Specifications . . 93
Wheel Removal 92

Free Manuals Download Website

<http://myh66.com>

<http://usermanuals.us>

<http://www.somanuals.com>

<http://www.4manuals.cc>

<http://www.manual-lib.com>

<http://www.404manual.com>

<http://www.luxmanual.com>

<http://aubethermostatmanual.com>

Golf course search by state

<http://golfingnear.com>

Email search by domain

<http://emailbydomain.com>

Auto manuals search

<http://auto.somanuals.com>

TV manuals search

<http://tv.somanuals.com>