



**POLARIS**<sup>®</sup>  
The Way Out.

## **Sportsman X2 500 EFI**

**2006 Owner's Manual  
for Maintenance and Safety**



**Read this manual carefully.  
It contains important safety information.  
This is an adult vehicle only.  
Operation is prohibited for those under 16 years of age.**

# **WARNING**

Improper vehicle use can result in **SEVERE INJURY** or **DEATH**.



**ALWAYS USE  
AN APPROVED  
HELMET AND  
PROTECTIVE GEAR  
FOR OPERATOR  
AND PASSENGER**



**NEVER USE  
ON PUBLIC  
ROADS**



**NEVER CARRY  
MORE THAN  
ONE  
PASSENGER**



**NEVER USE  
WITH DRUGS  
OR ALCOHOL**

## **NEVER operate:**

- without proper training or instruction
- at speeds too fast for your skills, your passenger's skills or the conditions
- on public roads - a collision can occur with another vehicle
- with more than one passenger - passengers affect balance and steering and increase risk of losing control
- with a passenger under the age of 12

## **THE OPERATOR MUST ALWAYS:**

- use proper riding techniques to avoid vehicle overturns on hills and rough terrain, and in turns
- avoid paved surfaces - pavement may adversely affect handling and control
- reduce speed and use extra caution at all times when carrying a passenger - have passenger dismount when conditions require
- make sure passenger reads and understands this label and passenger safety label

**LOCATE AND READ OWNER'S MANUAL.  
FOLLOW ALL INSTRUCTIONS AND WARNINGS.**



For your nearest Polaris dealer,  
call 1-800-POLARIS  
or visit [www.polarisindustries.com](http://www.polarisindustries.com)  
Polaris Sales Inc., 2100 Hwy. 55,  
Medina, MN 55340  
Phone (763) 417-8650 Fax (763) 542-0599  
Part No. 9920361 Rev 02  
Printed in USA

 **WARNING**

The engine exhaust from this product contains chemicals known to cause cancer, birth defects or other reproductive harm.

A card containing important ATV safety information should be attached to the owner's manual on the next page. If you cannot locate this card, or if it has been removed, please call 1-800-342-3764 for assistance.

# WELCOME

Thank you for purchasing a Polaris vehicle, and welcome to our world-wide family of Polaris owners. We proudly produce an exciting line of utility and recreational products.

- Snowmobiles
- All-terrain vehicles (ATVs)
- *RANGER* utility vehicles
- Victory motorcycles

We believe Polaris sets a standard of excellence for all utility and recreational vehicles manufactured in the world today. Many years of experience have gone into the engineering, design, and development of your Polaris vehicle, making it the finest machine we've ever produced.

For safe and enjoyable operation of your vehicle, be sure to follow the instructions and recommendations in this owner's manual. Your manual contains instructions for minor maintenance, but information about major repairs is outlined in the Polaris Service Manual and should be performed only by a Factory Certified Master Service Dealer (MSD) Technician.

Your Polaris dealer knows your vehicle best and is interested in your total satisfaction. Be sure to return to your dealership for all of your service needs during, and after, the warranty period.

We also take great pride in our complete line of apparel, parts and accessories, available through our online store at [www.purepolaris.com](http://www.purepolaris.com). Have your accessories and clothing delivered right to your door!



**POLARIS**<sup>®</sup>  
**The Way Out.**

Copyright 2005 Polaris Sales Inc. All information contained within this publication is based on the latest product information at the time of publication. Due to constant improvements in the design and quality of production components, some minor discrepancies may result between the actual vehicle and the information presented in this publication. Depictions and/or procedures in this publication are intended for reference use only. No liability can be accepted for omissions or inaccuracies. Any reprinting or reuse of the depictions and/or procedures contained within, whether whole or in part, is expressly prohibited.

Printed in U.S.A.

2006 Sportsman X2 500 EFI Owner's Manual P/N 9920361

# TABLE OF CONTENTS

<b>VEHICLE IDENTIFICATION NUMBERS</b>	<b>5</b>
<b>SAFETY</b>	<b>6</b>
<b>CONTROLS</b>	<b>36</b>
<b>FEATURES</b>	<b>43</b>
<b>OPERATION</b>	<b>52</b>
<b>EMISSION CONTROL SYSTEMS</b>	<b>73</b>
<b>MAINTENANCE</b>	<b>74</b>
<b>ADJUSTMENTS</b>	<b>115</b>
<b>POLARIS PRODUCTS</b>	<b>117</b>
<b>TROUBLESHOOTING</b>	<b>118</b>
<b>SPECIFICATIONS</b>	<b>122</b>
<b>WARRANTY</b>	<b>124</b>
<b>MAINTENANCE LOG</b>	<b>130</b>
<b>INDEX</b>	<b>132</b>



# VEHICLE IDENTIFICATION NUMBERS

Record your ATV's identification numbers and key number in the spaces provided. Remove the spare key and store it in a safe place. Your key can be duplicated only by mating a Polaris key blank with one of your existing keys, so if both keys are lost, the ignition switch must be replaced.

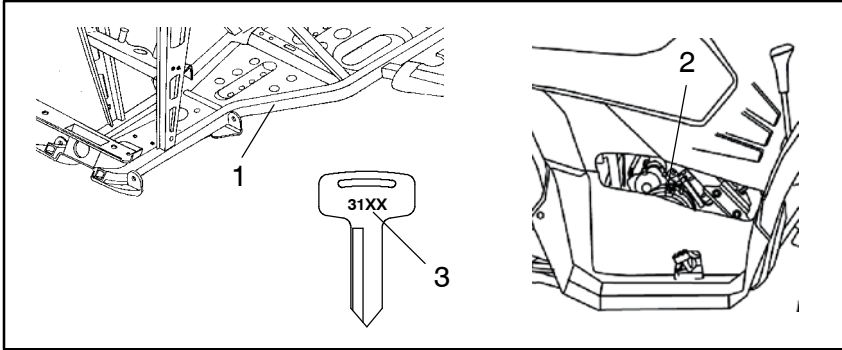

Vehicle Model Number: \_\_\_\_\_

Frame VIN (1): \_\_\_\_\_

Engine Serial Number (2): \_\_\_\_\_

Key Number (3): \_\_\_\_\_



# SAFETY

## Safety Decals and Locations

Warning decals have been placed on the ATV for your protection. Read and follow the instructions of the decals on the ATV carefully. If any of the decals depicted in this manual differ from the decals on your ATV, always read and follow the instructions of the decals *on the ATV*.

If any decal becomes illegible or comes off, contact your Polaris dealer to purchase a replacement. Replacement *safety* decals are provided by Polaris at no charge. The part number is printed on the decal.

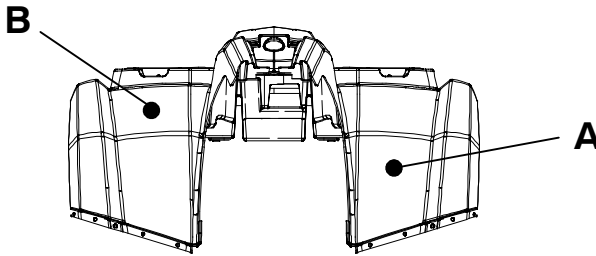

### **WARNING**

- Never operate this vehicle on HILLS steeper than 15 degrees. To prevent flipover on hilly terrain, when going up or down, use throttle and brakes gradually.
- Never operate this vehicle in TURF mode on irregular terrain, including hills and obstacles.
- REVERSE operation can be dangerous even at low speeds. Steering becomes difficult. To prevent flipover, avoid sudden braking or sharp turns.
- Use OVERRIDE for reverse speed limiter with caution. To prevent loss of control, never activate override button with open throttle.
- When this vehicle is not in operation or unattended, place shift in the park position.

7173948

**A**

## Safety Decals and Locations

### **⚠ WARNING**

Improper vehicle use can result in **SEVERE INJURY** or **DEATH**.



**ALWAYS USE  
AN APPROVED  
HELMET AND  
PROTECTIVE GEAR  
FOR OPERATOR  
AND PASSENGER**



**NEVER USE  
ON PUBLIC  
ROADS**



**NEVER CARRY  
MORE THAN  
ONE  
PASSENGER**



**NEVER USE  
WITH DRUGS  
OR ALCOHOL**

#### **NEVER operate:**

- without proper training or instruction
- at speeds too fast for your skills, your passenger's skills, or the conditions
- on public roads - a collision can occur with another vehicle
- with more than one passenger - passengers affect balance and steering and increase risk of losing control
- with a passenger under the age of 12

#### **THE OPERATOR MUST ALWAYS:**

- use proper riding techniques to avoid vehicle overturns on hills and rough terrain and in turns
- avoid paved surfaces - pavement may seriously affect handling and control
- reduce speed and use extra caution at all times when carrying a passenger - have passenger dismount when conditions require
- make sure passenger reads and understands this label and passenger safety label

**LOCATE AND READ OWNER'S MANUAL.  
FOLLOW ALL INSTRUCTIONS AND WARNINGS.  
IF OWNER'S MANUAL IS MISSING, CONTACT  
A POLARIS DEALER FOR A REPLACEMENT.**

©1997, 2000

7173889

**B**

7

# SAFETY

## Safety Decals and Locations

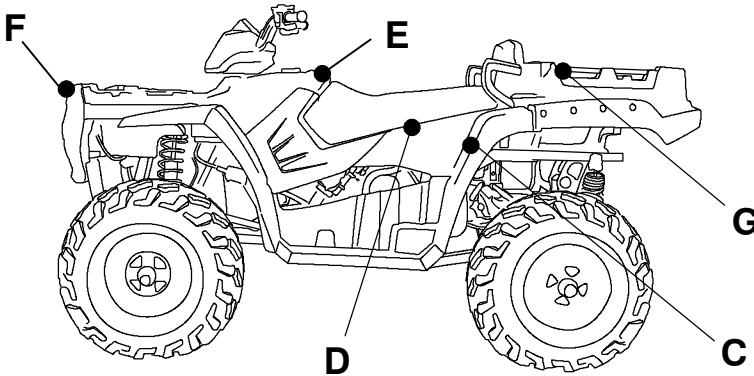

### **⚠ WARNING**

IMPROPER TIRE PRESSURE OR OVERLOADING can cause loss of control resulting in SEVERE INJURY OR DEATH.

**TIRE PRESSURE IN PSI (KPa): FRONT 5 (34.5) REAR 5 (34.5)**

**MAXIMUM WEIGHT CAPACITY** (Gross Vehicle Weight) INCLUDING MACHINE, OPERATOR, PASSENGER AND CARGO IS 1500 LBS. (680 kg)

Reduce speed and allow greater distance for braking when carrying cargo. Overloading or carrying tall, off-center, or unsecured loads will increase your risk of losing control. Loads should be centered, carried as low as possible in box, and firmly secured to the rack. For stability on rough or hilly terrain, reduce speed and cargo. Do not block headlight. Be careful if load extends over the side of the rack or box.

Read Owner's Manual for more detailed loading information.

7173900

C

### **ATTENTION**

- Operation of this vehicle without the air filter element will severely damage the engine.
- Clean pre-filter element often, more frequent cleaning required in dusty conditions. Do not operate vehicle without pre-filter.

7172921

D

## Safety Decals and Locations

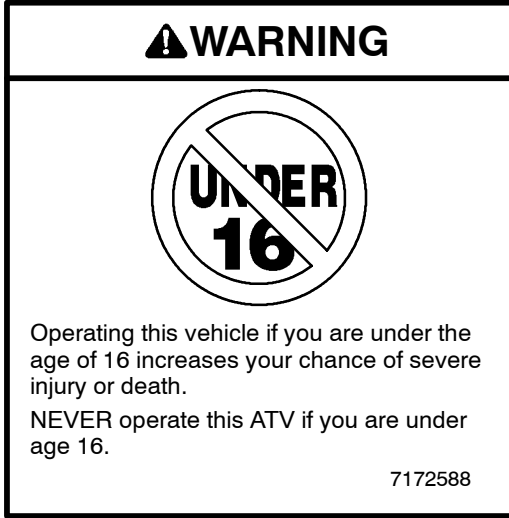

**E**

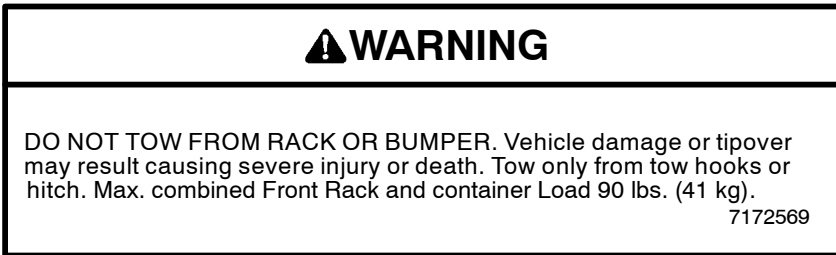

**F**

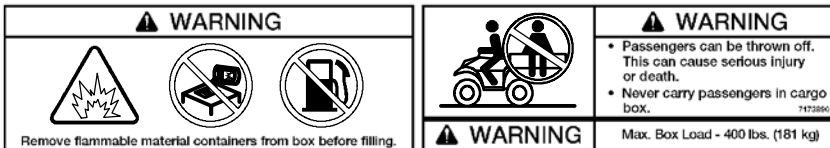

**G**

### WARNING

Remove flammable material containers from box before filling.

### WARNING

Passengers can be thrown off. This can cause serious injury or death.

Never carry passengers in cargo box.

Max. Box Load - 400 lbs. (181 kg)

# SAFETY

## Safety Decals and Locations

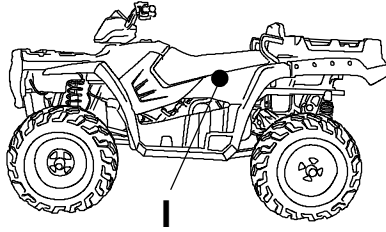
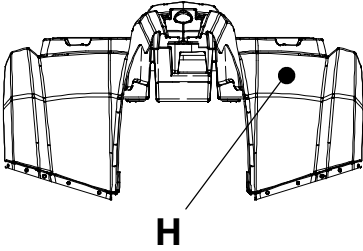

**⚠ WARNING**

**PASSENGER SAFETY**

To reduce the risk of **SEVERE INJURY** or **DEATH**.



**PASSENGER  
UNDER  
12**

**NEVER CARRY  
A PASSENGER  
UNDER AGE 12**



**NEVER CARRY  
MORE THAN ONE  
PASSENGER**



**NEVER RIDE AFTER  
USING DRUGS OR  
ALCOHOL**

**NEVER** carry a passenger too small to firmly plant feet on footrests and securely grasp hand holds.

**THE PASSENGER MUST ALWAYS:**

- use an approved helmet and protective gear
- securely grasp hand holds and plant feet firmly on footrests
- tell operator to slow down or stop if uncomfortable - get off and walk if conditions require

7174028

H

## Safety Decals and Locations

**⚠ WARNING**

- **Moving parts hazard under belt-clutch guard. To prevent serious injury, do not operate vehicle with guard removed.**
- **Do not modify engine or clutch. Doing so can cause part failure, possible imbalance, and excessive engine RPM, which can result in serious injury or death.**

NO STEP

7172563

**⚠ WARNING**

Pushing reverse override button may cause sudden increases in power and traction if too much throttle is applied. Loss of control or forward flipover may result, especially in AWD. See Owner's Manual.

7172564



**MANUFACTURED BY: POLARIS IND. INC.**

DATE:

VIN:

THIS VEHICLE IS AN ALL TERRAIN VEHICLE AND IS NOT INTENDED FOR USE ON PUBLIC ROADS.

CE VÉHICULE EST UN VÉHICULE TOUT TERRAIN QUI N'EST PAS DESTINÉ À ÊTRE UTILISÉ SUR LES CHEMINS PUBLICS.

PATENT NOTICE Mfd. by All Terrain Vehicle Division, Polaris Industries Inc. under one or more of the following patents: Other patents pending, U.S. Patents

4697665	5036939	5975624
6016943	6092877	6149540
8224134	8270106	8340186
D378080	D389440	D400143



7171492

Canadian Certification Decal

ALL WHEEL DRIVE SWITCH

Do not push switch to engage AWD if the rear wheels are spinning. This may cause severe drive shaft and clutch damage. See your Owner's Manual.

7079780

TRAILER MAX WEIGHT:  
1225 LBS. (557 KG) ON LEVEL GROUND

HITCH MAX. VERTICAL WEIGHT: 120 LBS. (55KG)

7174159

# SAFETY

## Safety Training

ATV safety training is a top priority for Polaris. When you purchased your new ATV, your dealer instructed you on the authorized *ATV RiderCourse*<sup>sm</sup> available to you and your eligible family members. This training is included in the purchase price of your ATV. Polaris strongly encourages you and your eligible family members who will be riding the ATV to take the *ATV RiderCourse*<sup>sm</sup>. You were also provided with printed materials that explain safe operating procedures. You should review this information on a regular basis.

If you purchased a used Polaris ATV, you can take the *ATV RiderCourse*<sup>sm</sup> by calling ATV Enrollment Express at (800) 887-2887 or by visiting [www.atvsafety.org](http://www.atvsafety.org). Purchasers of a used Polaris ATV will be charged for this training.

A Polaris ATV is an off-road vehicle. Familiarize yourself with all laws and regulations concerning the operation of the ATV in your area.

We strongly advise you to strictly follow the recommended maintenance program outlined in your owner's manual. This preventive maintenance program is designed to ensure that all critical components on your vehicle are thoroughly inspected at specific intervals.

## Age Restrictions

This vehicle is an **ADULT VEHICLE ONLY**. Operation is prohibited for anyone under 16 years of age. Never allow anyone under 12 years of age to ride as a passenger on this 2-up ATV.

## Know Your Vehicle

As the operator of the vehicle, you are responsible for your personal safety, the safety of others (including your passenger), and the protection of our environment. Read and understand your owner's manual, which includes valuable information about all aspects of your vehicle, including safe operating procedures.

## Safe Riding Gear

Always wear clothing suited to the type of riding. ATV riding requires special protective clothing for comfort and to reduce the chance of injury.

### 1. Helmet

Your helmet is the most important piece of protective gear for safe riding. A helmet can prevent a severe head injury.

Select an approved helmet that meets or exceeds your state's safety standards and bears either the Department of Transportation (DOT) label, the American National Standards Institute label (ANSI z90.1), or the Snell Memorial Foundation label.

A passenger's helmet should have a rigid chin guard.

### 2. Eye Protection

Do not depend on sunglasses for proper eye protection. A pair of goggles or a helmet face shield offer the best protection for your eyes. They should be kept clean and be of shatterproof design (bearing the markings Z2.1 or VESC 8).

### 3. Gloves

Off-road style gloves with knuckle pads are the best for comfort and protection.

### 4. Boots

The best footwear is a pair of strong over-the-calf boots with heels, like moto-cross boots.

### 5. Clothing

Always wear long sleeves and long pants to protect arms and legs. Riding pants with kneepads and a jersey with shoulder pads provide the best protection.

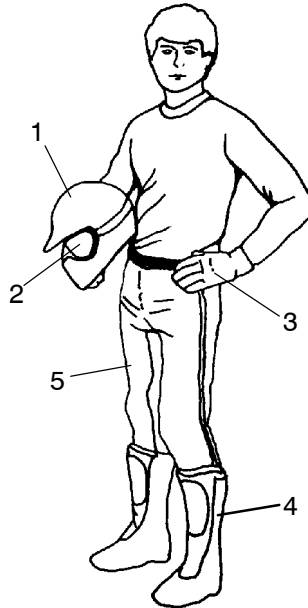



# SAFETY

## Rider Safety

### **WARNING**

Failure to follow the warnings contained in this manual can result in serious injury or death.

A Polaris ATV is not a toy and can be hazardous to operate. This vehicle handles differently than other vehicles, such as motorcycles and cars. A collision or rollover can occur quickly, even during routine maneuvers like turning, or driving on hills or over obstacles, if you fail to take proper precautions.

Read and understand your owner's manual and all warnings before operating a Polaris ATV.

*The following signal words and symbols appear in this manual and on your vehicle. Your safety is involved when these words and symbols are used. Become familiar with their meanings before reading the manual.*



The *safety alert symbol*, on your vehicle or in this manual, alerts you to the potential for personal injury.



### **WARNING**

The *safety alert warning* indicates a potential hazard that may result in serious injury or death.



### **CAUTION**

The *safety alert caution* indicates a potential hazard that may result in minor personal injury or damage to the vehicle.

### **CAUTION**

A *caution* indicates a situation that may result in damage to the vehicle.

### **NOTE:**

A *note* will alert you to important information or instructions.

## Rider Safety

### **WARNING**

Serious injury or death can result if you do not follow these instructions and procedures, which are outlined in further detail within your owner's manual.

- Read this manual and all labels carefully, and follow the operating procedures described.
- Never operate an ATV without proper instruction. *Take a training course.* Purchasers of a new Polaris ATV and their eligible family members are entitled to take the *ATV RiderCourse<sup>sm</sup>*. Contact *ATV Enrollment Express* at (800) 887-2887 or visit [www.atvsafety.org](http://www.atvsafety.org) for information on enrollment in the *ATV RiderCourse<sup>sm</sup>*.
- Never allow anyone under 16 years of age to operate this ATV.
- Never allow anyone under 12 years of age to ride as a passenger on this 2-up ATV. Make sure any passenger is tall enough to comfortably and safely reach the handgrips and footrests.
- Never secure a passenger to the vehicle or to the operator with a belt, rope or similar device.
- Never carry more than one passenger on this 2-up ATV.
- Always make sure the passenger seat lock-out is functioning properly before carrying a passenger.
- Never permit a guest to operate the ATV unless the guest has read this manual and all product labels and has completed a certified safety training course.
- Always keep both hands on the handlebars and both feet on the footrests of the ATV during operation. A passenger should always be seated in the passenger seat with both feet on the footrests and both hands on the passenger grab handles at all times. The passenger should never hold on to the operator.
- Always avoid operating an ATV on paved surfaces, including sidewalks, driveways, parking lots, and streets.
- Never operate an ATV on a public street, road or highway, including a dirt or gravel road.
- Never ride an ATV without wearing an approved helmet that fits properly. Always wear eye protection (goggles or face shield), gloves, boots, a long-sleeved shirt or jacket, and long pants. A passenger's helmet should have a rigid chin guard.
- Never consume alcohol or drugs before or while riding an ATV.

# SAFETY

## Rider Safety

- Never operate at excessive speeds. Travel at speeds appropriate for your skills, your passenger's skills, and operating conditions.
- Never attempt wheelies, jumps or other stunts.
- Always inspect your ATV before each use to make sure it's in safe operating condition. Always follow the inspection and maintenance procedures and schedules outlined in your owner's manual.
- Always travel slowly and use extra caution when operating on unfamiliar terrain. Be alert to changing terrain conditions.
- Never operate on excessively rough, slippery, or loose terrain.
- Always follow proper turning procedures as described in this manual. Practice turning at low speeds before attempting to turn at faster speeds. Do not turn at excessive speeds.
- Always have the ATV inspected by an authorized Polaris dealer if it's been involved in an accident.
- Always be careful of skidding or sliding. On slippery surfaces like ice, travel slowly and use extra caution to reduce the chance of skidding or sliding out of control.
- Never operate on hills too steep for the ATV or for your abilities.
- Never operate this ATV in TURF mode while operating on a hill or other irregular terrain. See page 43.
- Always follow proper procedures for climbing hills. Check the terrain carefully before ascending a hill. Never climb hills with excessively slippery or loose surfaces. Shift body weight uphill. Never open the throttle suddenly or make sudden gear changes. Never go over the top of a hill at high speed. Switch the AWD switch out of TURF mode and into AWD mode when ascending a hill.
- Always follow proper procedures for going downhill and for braking on hills. Check the terrain carefully before you start down a hill. Shift body weight uphill. Never go down a hill at high speed. Avoid going down a hill at an angle, which would cause the vehicle to lean sharply to one side. Travel straight down the hill when possible.
- Always follow proper procedures for crossing the side of a hill. Do not cross a hillside with a passenger on board. Avoid hills with excessively slippery or loose surfaces. Shift body weight uphill. Never attempt to turn the ATV around on any hill until you've mastered (on level ground) the turning technique outlined in this manual. Avoid crossing the side of a steep hill when possible.

## Rider Safety

- Always use proper procedures if you stall or roll backwards while climbing a hill. To avoid stalling, maintain a steady speed when climbing a hill. If you stall or roll backwards, follow the special procedure for braking described in this manual. Always dismount on the uphill side, or to either side if the ATV is pointed straight uphill. Turn the ATV around and remount following the procedure described in this manual.
- Always check for obstacles before operating in a new area. Never attempt to operate over large obstacles, such as rocks or fallen trees. Always follow proper procedures when operating over obstacles as described in this manual.
- Avoid operating the ATV through deep or fast-flowing water. If it's unavoidable, travel slowly, balance your weight carefully, avoid sudden movements, and maintain a slow and steady forward motion. Do not make sudden turns or stops, and do not make sudden throttle changes.
- Wet brakes may have reduced stopping ability. Test the brakes after leaving water. If necessary, apply them lightly several times to allow friction to dry out the pads.
- Always check for obstacles or people behind the ATV before operating in reverse. Be aware that a passenger can obstruct your view. When it's safe to proceed in reverse, move slowly and avoid turning at sharp angles.
- Always use the size and type of tires specified for your ATV, and always maintain proper tire pressure.
- Never modify an ATV through improper installation or use of accessories.
- Never exceed the stated load capacity for your ATV. Cargo must be properly distributed and securely attached. Reduce speed and follow the instructions in this manual for carrying cargo or towing. Allow a greater distance for braking.

**FOR MORE INFORMATION ABOUT ATV SAFETY, call the Consumer Product Safety Commission at 1-800-638-2772, or visit [www.cpsc.gov](http://www.cpsc.gov), visit [www.atvsafety.org](http://www.atvsafety.org), or call Polaris at 1-800-342-3764.**

# SAFETY

## Rider Safety

### Equipment Modifications

We are concerned for the safety of our customers and for the general public. Therefore, we strongly recommend that consumers do not install on a Polaris ATV any equipment that may increase the speed or power of the vehicle, or make any other modifications to the vehicle for these purposes. Any modifications to the original equipment of the vehicle create a substantial safety hazard and increase the risk of bodily injury.

The warranty on your Polaris ATV is terminated if any equipment has been added to the vehicle, or if any modifications have been made to the vehicle, that increase its speed or power.

**NOTE:** The addition of certain accessories, including (but not limited to) mowers, blades, tires, sprayers, or large racks, may change the handling characteristics of the vehicle. Use only Polaris-approved accessories, and familiarize yourself with their function and effect on the vehicle.

## Rider Safety

### **WARNING**

#### POTENTIAL HAZARD

Operating this ATV without proper instruction.

#### WHAT CAN HAPPEN

The risk of an accident is greatly increased if the operator does not know how to operate the ATV properly in different situations and on different types of terrain.

#### HOW TO AVOID THE HAZARD

Beginning and inexperienced operators should complete the ATV *RiderCourse*<sup>sm</sup> offered by Polaris through the SVIA. They should then regularly practice the skills learned in the course and the operating techniques described in the Owner's Manual.

For more information about the ATV *RiderCourse*<sup>sm</sup> contact ATV Enrollment Express at (800) 887-2887 or visit [www.atvsafety.org](http://www.atvsafety.org).

### **WARNING**

#### POTENTIAL HAZARD

Failure to follow the age recommendations for this ATV.

#### WHAT CAN HAPPEN

Severe injury and/or death could occur if a child under the minimum age recommendation operates this ATV or rides as a passenger.

Even though a child may be within the recommended age group for operating some ATVs, he/she may not have the skills, abilities, or judgment needed to operate or ride on this ATV safely and could be susceptible to accident or injury.

#### HOW TO AVOID THE HAZARD

No one under the age of 16 should operate this ATV. Never allow anyone under 12 years of age to ride as a passenger on this 2-up ATV.

# SAFETY

## Rider Safety

### **⚠ WARNING**

#### POTENTIAL HAZARD

Operating with more than one passenger.

#### WHAT CAN HAPPEN

Passengers affect balance and steering and increase the risk of losing control, which can result in severe injury or death.

#### HOW TO AVOID THE HAZARD

Never operate the 2-up ATV with more than one passenger.



### **⚠ WARNING**

#### POTENTIAL HAZARD

Carrying a passenger in the cargo box.

#### WHAT CAN HAPPEN

A passenger riding in the cargo box could fall from the vehicle unexpectedly or may contact moving components, both of which can result in severe injury or death.

#### HOW TO AVOID THE HAZARD

Never allow a passenger to ride in the cargo box.



## Rider Safety

### **⚠ WARNING**

#### POTENTIAL HAZARD

Operating an ATV on paved surfaces, including sidewalks, paths, parking lots, and driveways.

#### WHAT CAN HAPPEN

ATV tires are designed for off-road use. Operating on paved surfaces may seriously affect the handling and control of the ATV and could result in loss of control, accident, and/or injury.

#### HOW TO AVOID THE HAZARD

Avoid operating the ATV on pavement. If it's unavoidable, travel slowly and avoid sudden turns or stops.



### **⚠ WARNING**

#### POTENTIAL HAZARD

Operating this ATV on public streets, roads or highways.

#### WHAT CAN HAPPEN

The ATV could collide with another vehicle.

#### HOW TO AVOID THE HAZARD

Never operate the ATV on any public street, road or highway, including dirt and gravel roads. In many areas it's illegal to operate ATVs on public streets, roads and highways.





# SAFETY

## Rider Safety

### **⚠ WARNING**

#### POTENTIAL HAZARD

Riding an ATV without wearing an approved helmet, eye protection and protective clothing.

#### WHAT CAN HAPPEN

Riding an ATV without an approved helmet increases the risk of a severe head injury or death in the event of an accident.

Riding without eye protection could result in an accident and could increase the chance of a severe injury in the event of an accident.

#### HOW TO AVOID THE HAZARD

Always be sure operator and passenger wear an approved helmet that fits properly. A passenger's helmet should have a rigid chin guard.

Always be sure operator and passenger wear eye protection (goggles or face shield), gloves, boots, a long-sleeved shirt or jacket, and long pants.



## Rider Safety

### **⚠️ WARNING**

#### POTENTIAL HAZARD

Riding the ATV after consuming alcohol or drugs.

#### WHAT CAN HAPPEN

Consumption of alcohol and/or drugs could seriously affect operator (and passenger) judgment. Reaction time may be slower. Balance and perception could be affected.

Consuming alcohol and/or drugs before or while riding an ATV could result in an accident causing severe injury or death.

#### HOW TO AVOID THE HAZARD

DO NOT drink alcohol or use drugs or medications before or while driving the ATV or riding as a passenger.



### **⚠️ WARNING**

#### POTENTIAL HAZARD

Operating the ATV at excessive speeds.

#### WHAT CAN HAPPEN

Excessive speed increases the operator's chance of losing control of the ATV, which can result in an accident causing severe injury or death.

#### HOW TO AVOID THE HAZARD

Never operate at excessive speeds. Travel at speeds appropriate for your skills, your passenger's skills, and operating conditions.

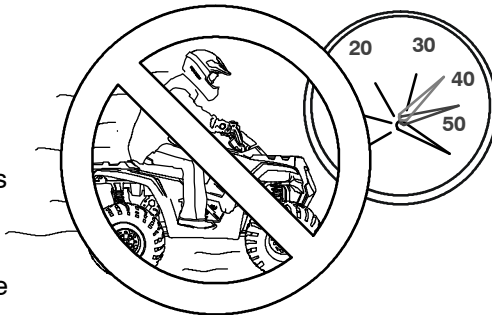

# SAFETY

## Rider Safety

### **⚠️ WARNING**

#### POTENTIAL HAZARD

Attempting wheelies, jumps and other stunts.

#### WHAT CAN HAPPEN

Attempting stunts increases the chance of an accident, including an overturn.

#### HOW TO AVOID THE HAZARD

Never attempt wheelies, jumps, or other stunts. Avoid exhibition driving.



### **⚠️ WARNING**

#### POTENTIAL HAZARD

Failure to inspect the ATV before operating.

Failure to properly maintain the ATV.

#### WHAT CAN HAPPEN

Poor maintenance increases the possibility of an accident or equipment damage.

#### HOW TO AVOID THE HAZARD

Always inspect your ATV before each use to make sure it's in safe operating condition.

Always follow the inspection and maintenance procedures and schedules described in the owner's manual.

## Rider Safety

### **⚠️ WARNING**

#### POTENTIAL HAZARD

Operating on frozen bodies of water.

#### WHAT CAN HAPPEN

Severe injury or death can result if the ATV and/or the operator fall through the ice.

#### HOW TO AVOID THE HAZARD

Never operate the ATV on a frozen body of water.

### **⚠️ WARNING**

#### POTENTIAL HAZARD

Removing hands from the handlebars or feet from the footrests during operation.

#### WHAT CAN HAPPEN

Removing even one hand or foot can reduce ability to control the vehicle or could cause loss of balance and ejection from the ATV.

If a person's feet are not firmly planted on the footrests, they could come into contact with the wheels or other moving parts and lead to accident or injury.

#### HOW TO AVOID THE HAZARD

Always keep both hands on the handlebars and both feet on the footrests of the ATV during operation. A passenger should always be seated in the passenger seat with both feet on the footrests and both hands on the passenger grab handles at all times. The passenger should never hold on to the operator.



# SAFETY

## Rider Safety

### **⚠ WARNING**

#### POTENTIAL HAZARD

Failure to use extra caution when operating the ATV on unfamiliar terrain.

#### WHAT CAN HAPPEN

Unfamiliar terrain may contain hidden rocks, bumps, or holes that could cause loss of control or overturn.

#### HOW TO AVOID THE HAZARD

Travel slowly and use extra caution when operating on unfamiliar terrain. Always be alert to changing terrain conditions.



### **⚠ WARNING**

#### POTENTIAL HAZARD

Failure to use extra caution when operating on excessively rough, slippery or loose terrain.

#### WHAT CAN HAPPEN

Operating on excessively rough, slippery or loose terrain could cause loss of traction or loss of control, which could result in an accident or overturn.

#### HOW TO AVOID THE HAZARD

Do not operate on excessively rough, slippery or loose terrain until you've learned and practiced the skills necessary to control the ATV on such terrain.

Always use extra caution on rough, slippery or loose terrain.

Never operate this ATV in TURF mode while driving on uneven, loose, or slippery terrain conditions. See page 43.

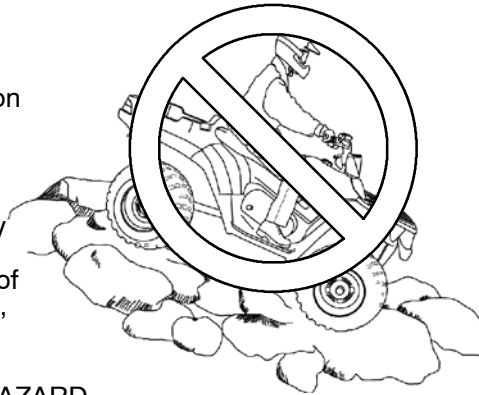

## Rider Safety

### **⚠ WARNING**

#### POTENTIAL HAZARD

Turning improperly.

#### WHAT CAN HAPPEN

Improper turns could cause loss of control and lead to a collision or overturn.

#### HOW TO AVOID THE HAZARD

Always follow proper procedures for turning as described in the owner's manual.

Practice turning at slow speeds before attempting to turn at faster speeds.

Never turn at excessive speed.

### **⚠ WARNING**

#### POTENTIAL HAZARD

Operating on excessively steep hills.

#### WHAT CAN HAPPEN

The vehicle may overturn.

#### HOW TO AVOID THE HAZARD

Never operate on hills too steep for the ATV or for your abilities.

Never operate the ATV on hills steeper than 15°.



# SAFETY

## Rider Safety

### **⚠ WARNING**

#### POTENTIAL HAZARD

Climbing hills improperly.

#### WHAT CAN HAPPEN

Improper hill climbing could cause loss of control or overturn.

#### HOW TO AVOID THE HAZARD

Always follow proper procedures for climbing hills as described in the owner's manual. See page 61.

Always check the terrain carefully before ascending any hill.

Never climb hills with excessively slippery or loose surfaces.

Shift body weight uphill. A passenger should also shift body weight uphill.

Never open the throttle suddenly while traveling uphill. The ATV could flip over backwards.

Never go over the top of any hill at high speed. An obstacle, a sharp drop, or another vehicle or person could be on the other side of the hill.

Never operate this ATV in TURF mode while operating on a hill or other irregular terrain. See page 43.

Switch the AWD switch out of TURF mode and into AWD mode when ascending a hill.

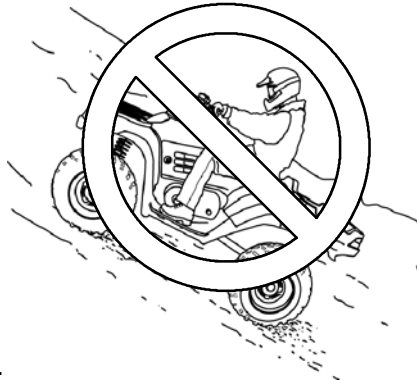

## Rider Safety

### **⚠ WARNING**

#### POTENTIAL HAZARD

Traveling downhill improperly.

#### WHAT CAN HAPPEN

Improperly descending a hill could cause loss of control or overturn.

#### HOW TO AVOID THE HAZARD

Always follow proper procedures for traveling down hills as described in the owner's manual. See page 63.

Always check the terrain carefully before descending a hill.

Never operate this ATV in TURF mode while operating on a hill or other irregular terrain. See page 43.

Always descend a hill with the transmission in forward gear. Do not descend a hill with the transmission in neutral.

Shift body weight uphill. A passenger should also shift body weight uphill.

Never travel down a hill at high speed.

Avoid traveling down a hill at an angle, which would cause the vehicle to lean sharply to one side. Travel straight down the hill when possible.





# SAFETY

## Rider Safety

### **⚠ WARNING**

#### POTENTIAL HAZARD

Improperly crossing hills and turning on hills.

#### WHAT CAN HAPPEN

Improperly crossing or turning as hills could cause loss of control or overturn.

#### HOW TO AVOID THE HAZARD

Never attempt to turn the ATV around on any hill until you've mastered the turning technique (on level ground) as described in the owner's manual. See page 64. Use extra caution when turning on any hill.

Do not cross a hillside with a passenger on board.

Avoid crossing the side of a steep hill.

#### When crossing the side of a hill:

Always follow proper procedures as described in the owner's manual.

Avoid hills with excessively slippery or loose surfaces.

Shift body weight uphill.



## Rider Safety

### **⚠ WARNING**

#### POTENTIAL HAZARD

Stalling, rolling backwards or improperly dismounting while climbing a hill.

#### WHAT CAN HAPPEN

The vehicle could overturn.

#### HOW TO AVOID THE HAZARD

Maintain steady speed when climbing a hill.

#### If all forward speed is lost:

Lean forward to keep body weight uphill. A passenger should also lean uphill.

Apply the single lever brakes.

Lock the parking brake when fully stopped.

Dismount on the uphill side of the vehicle, or on the left if the vehicle is pointing straight uphill. Have a passenger dismount first, then the operator may dismount.

Turn the ATV around and remount, following the procedure described in the owner's manual. See page 64.

#### If the ATV begins rolling backwards:

Keep operator and passenger body weight uphill.

Never apply engine power.

Never apply the rear brake while rolling backwards.

Apply the single-lever brake gradually.

When fully stopped, apply the foot brake as well, and then lock the parking brake.

Dismount on the uphill side of the vehicle, or on the left if the vehicle is pointing straight uphill. Have a passenger dismount first, then the operator may dismount.

Turn the ATV around and remount, following the procedure described in the owner's manual. See page 64.



# SAFETY

## Rider Safety

### **WARNING**

#### POTENTIAL HAZARD

Improperly operating over obstacles.

#### WHAT CAN HAPPEN

Operating over obstacles could cause loss of control or overturn.

#### HOW TO AVOID THE HAZARD

Before operating in a new area, check for obstacles.

Avoid operating over large obstacles such as rocks and fallen trees when possible. If unavoidable, use extreme caution and always follow proper procedures as outlined in the owner's manual. Always have a passenger dismount before operating over an obstacle that could cause a fall from the vehicle or vehicle tipover.

### **WARNING**

#### POTENTIAL HAZARD

Skidding or sliding.

#### WHAT CAN HAPPEN

Skidding or sliding can cause loss of control.

If the tires regain traction unexpectedly, the ATV could overturn.

#### HOW TO AVOID THE HAZARD

On slippery surfaces such as ice, travel slowly and use extra caution to reduce the chance of skidding or sliding out of control.

### **WARNING**

#### POTENTIAL HAZARD

Improperly operating in reverse.

#### WHAT CAN HAPPEN

The ATV could collide with an obstacle or person, resulting in severe injury.

#### HOW TO AVOID THE HAZARD

Before shifting into reverse gear, always check for obstacles or people behind the ATV. When it's safe to proceed, back slowly. Be aware that a passenger can obstruct your view.

## Rider Safety

### **WARNING**

#### POTENTIAL HAZARD

Operating the ATV through deep or fast-flowing water.

#### WHAT CAN HAPPEN

Tires may float, causing loss of traction and loss of control, which could lead to an accident or overturn.

#### HOW TO AVOID THE HAZARD

Avoid operating the ATV through deep or fast-flowing water. If it's unavoidable to enter water that exceeds the recommended maximum depth (see page 66), travel slowly, balance your weight carefully, avoid sudden movements, and maintain a slow and steady forward motion. Do not make sudden turns or stops, and do not make sudden throttle changes.

Wet brakes may have reduced stopping ability. Always test the brakes after leaving water. If necessary, apply them several times to let friction dry out the pads.

### **WARNING**

#### POTENTIAL HAZARD

Operating this ATV with improper tires, or with improper or uneven tire pressure.

#### WHAT CAN HAPPEN

Use of improper tires, or operation of the ATV with improper or uneven tire pressure, could cause loss of control or accident.

#### HOW TO AVOID THE HAZARD

Always use the size and type of tires specified for the ATV.

Always maintain proper tire pressure as specified.

# SAFETY

## Rider Safety

### **WARNING**

#### POTENTIAL HAZARD

Operating the ATV with improper modifications.

#### WHAT CAN HAPPEN

Improper installation of accessories or modification of the ATV may cause changes in handling which could lead to an accident.

#### HOW TO AVOID THE HAZARD

Never modify the ATV through improper installation or use of accessories. All parts and accessories added to the vehicle must be genuine Polaris Industries Inc. or equivalent components designed for use on this ATV and should be installed and used according to approved instructions. See your authorized Polaris ATV dealer for more information.

### **WARNING**

#### POTENTIAL HAZARD

Overloading the ATV or carrying/towing cargo improperly.

#### WHAT CAN HAPPEN

Overloading and towing can cause changes in vehicle handling, which could lead to loss of control or an accident.

#### HOW TO AVOID THE HAZARD

Never exceed the stated load capacity for this ATV.

Make sure cargo is properly distributed and securely attached.

Reduce speed when carrying cargo or pulling a trailer. Allow a greater distance for braking.

Always follow the instructions in the owner's manual for carrying cargo or pulling a trailer. See page 70.

Always follow the instructions in the owner's manual for operating with a passenger. See page 58.

## Rider Safety

### **WARNING**

Leaving the keys in the ignition can lead to unauthorized use of the vehicle resulting in serious injury or death. Always remove the ignition key when the vehicle is not in use.

### **WARNING**

After any overturn or accident, have a qualified service dealer inspect the entire vehicle for possible damage, including (but not limited to) brakes, throttle and steering systems.

### **WARNING**

Safe operation of this rider-active vehicle requires good judgement and physical skills. Persons with cognitive or physical disabilities who operate this vehicle or ride as a passenger have an increased risk of overturn and loss of control, which could result in severe injury or death. Never secure a passenger to the vehicle or to the operator with a belt, rope or similar device.

### **CAUTION**

Exhaust system components are very hot during and after use of the vehicle. Hot components can cause serious burns and fire. Do not touch hot exhaust system components. Always keep combustible materials away from the exhaust system. Use caution when traveling through tall grass, especially dry grass.

# CONTROLS

## Engine Electrical Switches

### **⚠ WARNING**

Activating the override switch while the throttle is open can cause loss of control, resulting in severe injury or death. Do not activate the override switch while the throttle is open.

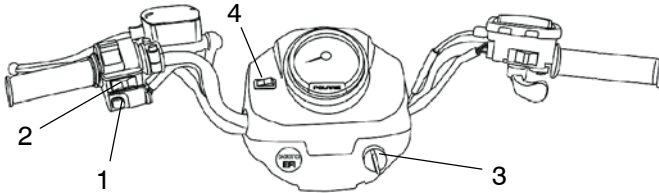

**Mode/Reverse Override Switch (1)** - This vehicle is equipped with a reverse speed limiter system. To gain additional power while backing, depress the override switch.

**NOTE:** The override switch also allows activation of AWD in reverse, if the AWD switch is on. This switch is also used to toggle through the different modes of the rider information center. See page 46.

**Engine Stop Switch (2)** - The engine will not start or run when the switch is in the *OFF* position. Its purpose is to provide the operator with a quick means of engine shutdown in case of an emergency.

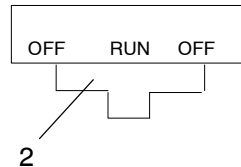

**Main Switch (3)** - To start the engine, slide the stop switch to the center *RUN* position and turn the main key switch clockwise past the *ON* position. Release the key when the engine starts.

**NOTE:** Both the main switch and the emergency engine stop switch will shut off all electrical power to the vehicle, including lights. To stop the engine, slide the stop switch either right or left to the *OFF* position.

**Worklight Switch (4)** - The worklight switch controls a light located at the rear of the vehicle. Use the rear light when additional light is needed for loading and unloading the vehicle. Turn the rear worklight off when driving the ATV.

## **⚠ WARNING**

Operating an ATV with sticking or improperly operating throttle controls could cause an accident and lead to severe injury or death.

Never start or operate an ATV with a sticking or improperly operating throttle. Always contact your dealer for service if throttle problems arise.

Failure to check or maintain proper operation of the throttle system can result in an accident if the throttle lever sticks during operation. Always check the lever for free movement and return before starting the engine. Also check occasionally during operation.

## **Throttle Lever**

Engine speed and vehicle movement are controlled by pressing the throttle lever (1). The throttle lever is spring loaded. Engine speed returns to idle when the lever is released.

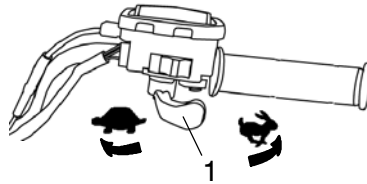

This ATV is equipped with Polaris Electronic Throttle Control (ETC), which is designed to reduce the risk of a frozen or stuck throttle. If the throttle cable should stick in an open position when the operator releases the throttle lever, the engine will stop, and power to the rear wheels will cease.

## **⚠ WARNING**

The Electronic Throttle Control (ETC) stops the engine in the event of a throttle system malfunction and is provided for your safety. Do not attempt to modify the ETC system or replace it with any after market throttle mechanisms.



# CONTROLS

## Light Switches

The light switch is located on the left handlebar. It's used to turn the lights on and off and to switch the lights from HI to LO.

**NOTE:** The lights won't work unless the key is in the *ON* position and the shut-off switch is in the *RUN* position.

## WARNING

Operating the ATV on streets or roads, especially in darkness, could result in an accident and serious injury or death.

Your ATV is not equipped with highway-approved lights. It's designed for and must be used for *off-road use only*. Use caution and drive at reduced speeds in conditions of reduced visibility such as fog, rain and darkness.

## Brake Lever

The front and rear brakes are applied by squeezing the brake lever (1) toward the handlebar. The front and rear brakes are hydraulically activated disc type brakes that are activated by only one lever.

Always test brake lever travel and master cylinder fluid level before riding.

When squeezed, the lever should feel firm. Any sponginess would indicate a possible fluid leak or low master cylinder fluid level, which must be corrected before riding. Contact your dealer for proper diagnosis and repairs.

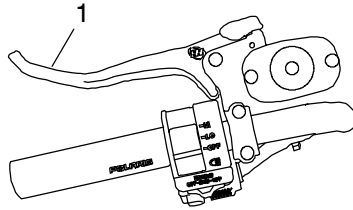

## WARNING

Operating the ATV with a spongy brake lever can result in loss of braking, which could cause an accident.

Never operate the ATV with a spongy-feeling brake lever.

# CONTROLS

## Master Cylinder

The brake fluid in the master cylinder (1), which is located on the left handlebar, should be checked before each ride. The fluid level can be seen through an indicator window (2) on the top of the master cylinder. This eye will appear dark when the fluid level is full. When fluid needs to be added, the eye will be clear.

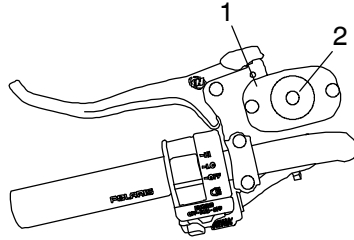

**NOTE:** When checking the fluid level, the ATV must be on level ground with the handlebars straight. If the fluid level is low add DOT 3 brake fluid only. See page 117 for the part numbers of Polaris products.

## WARNING

After opening a bottle of brake fluid, always discard any unused portion. Never store or use a partial bottle. Brake fluid is hygroscopic, meaning it rapidly absorbs moisture from the air. The moisture causes the boiling temperature of the brake fluid to drop, which can lead to early brake fade and the possibility of accident or severe injury.

# CONTROLS

## Parking Brake

### **⚠ WARNING**

Operating the ATV while the parking brake is engaged could result in an accident and serious injury or death. Always check to be sure the parking brake is disengaged before operating.

### **Setting the Parking Brake**

1. Place the transmission in PARK.
2. Squeeze and release the brake lever (1) two or three times, then squeeze and hold.
3. Push the park brake lock (2) forward to engage the brake. Release the brake lever.
4. To release the parking brake lock, squeeze and release the brake lever. It will return to its unlocked position.

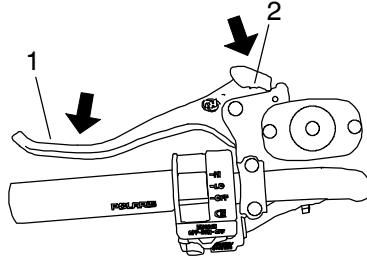

### **Important Safeguards**

- The parking brake may relax if left on for a long period of time. Always block the wheels to prevent rolling.
- Always block the wheels on the downhill side of the ATV if leaving it parked on a hill. Another option is to park the ATV in a sidehill position.
- Never depend on the parking brake alone if the ATV is parked on a hill. Always block the wheels to prevent rolling.

## Auxiliary Brake

### **⚠ WARNING**

Aggressively applying the auxiliary brake when backing down a hill may cause rear tipover, which could result in serious injury or death.

Use caution when applying the auxiliary brake. Do not aggressively apply the auxiliary brake when going forward. The rear wheels may skid and slide sideways, causing loss of control and serious injury or death.

Your Polaris ATV has an auxiliary brake for added safety. It's located on the inside of the right floor board and is operated by the right foot. The auxiliary brake serves as a backup to the main brake system if the main system becomes inoperative.

If the rear wheels slide while using the auxiliary brake, *reduce* brake pedal pressure to brake the rear wheels without skidding.

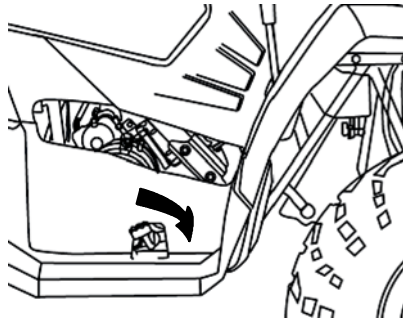

### **Brake Fluid Level**

Check the brake fluid level frequently for the auxiliary brake system. The reservoir is located under the seat or near the auxiliary brake. Maintain the fluid level between the maximum and minimum marks.

# CONTROLS

## Automatic Transmission Gear Selector

The transmission gear selector (1) is located on the right side of the vehicle.

H: High Gear  
L: Low Gear  
N: Neutral  
R: Reverse  
P: Park

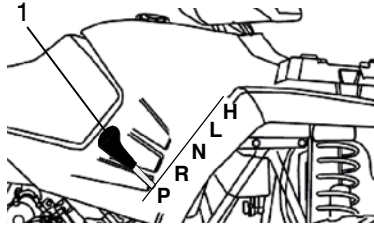

## CAUTION

Shifting gears with the engine speed above idle or while the vehicle is moving could cause transmission damage.

To change gears, stop the vehicle, and with the engine idling, move the lever to the desired gear.

Whenever the ATV is left unattended, always place the transmission in PARK and lock the parking brake.

## Belt Life

To extend belt life, use low forward gear in heavy pulling situations and when operating at less than seven miles per hour for extended periods of time.

## Fuel Tank

The fuel tank filler cap (1) is located directly below the handlebar. Use either leaded or unleaded gasoline with a minimum pump octane number of  $87 = (R + M/2)$  octane.

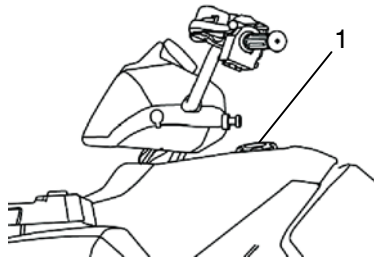

## Fuel Filter

The in-line fuel filter should be replaced by your dealer after every 200 hours of operation and any time the fuel becomes contaminated with dirt or debris. Do not attempt to clean the fuel filter.

# FEATURES

## All Wheel Drive (AWD) System

The AWD system is activated by a switch (1) on the right handlebar.

When the switch is on 2X4 (center position), the ATV is in two wheel drive at all times and the differential is locked.

When the switch is on AWD (left position), the ATV is in AWD and the differential is locked. When in AWD, the front gearcase will automatically engage any time the rear wheels lose traction. When the rear wheels regain traction, the front gearcase will automatically disengage. There is no limit to the length of time the vehicle may remain in AWD.

**NOTE:** The override switch allows activation of AWD in reverse if the AWD switch is on. See page 36.

When the switch is on TURF (right position), the differential is open, allowing the inside wheel to rotate independently from the outside wheel during turns. Operate this vehicle in TURF mode only to protect smooth, level surfaces from tire damage. Otherwise, switch out of TURF mode.

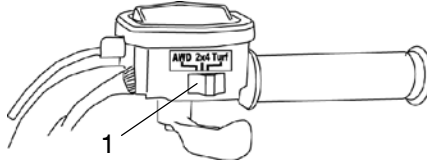

## WARNING

Operating in TURF mode when on sloped, uneven, or loose terrain could cause loss of control and result in serious injury or death. One rear wheel may slip and lose traction or may lift up and grab when it touches the ground again.

DO NOT operate in TURF mode when climbing or descending hills, when sidehilling, or when operating on uneven, loose, or slippery terrain conditions such as sand, gravel, ice, snow, obstacles, and water crossings.

Switch the All-Wheel Drive (AWD) system out of TURF mode whenever it is not required.

# FEATURES

## All Wheel Drive (AWD) System

### Engaging Front Gearcase

The AWD switch may be turned on or off while the vehicle is moving. Initially, the vehicle's electronic system will not enable the AWD until the engine RPM is below 3100. Once enabled, the AWD remains enabled until the AWD switch is turned off. If the switch is turned off while the front gearcase is moving, it will not disengage until the rear wheels regain traction.

Engage the AWD switch before getting into conditions where front wheel drive may be needed. If the rear wheels are spinning, release the throttle before switching to AWD.

## CAUTION

Switching to AWD (or from TURF to 2X4) while the rear wheels are spinning may cause severe drive shaft and gearcase damage. Always switch to AWD (or to TURF from 2X4) while the rear wheels have traction or are at rest.

## Passenger Seat

Always make sure the passenger seat lock-out is functioning properly before operating with a passenger.

Do not operate the vehicle with the seat in the 2-up position when operating without a passenger. Always return the seat to the 1-up position for single-rider operation.

Never carry cargo in the rear box when operating the ATV in the 2-up mode with a passenger.

## Seat Conversion

1. Make sure the cargo box dump lever (A) is securely latched.
2. Lift the latch (B) at the top of the operator backrest and tilt the backrest slightly forward.
3. Pull the passenger seat backrest (C) upward from the bed of the cargo box.

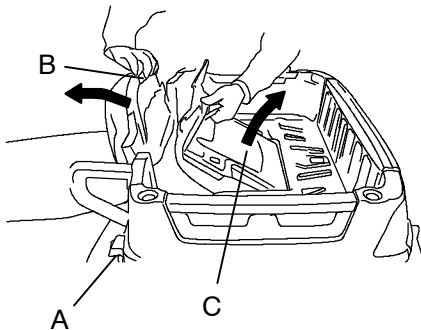

# FEATURES

## Passenger Seat

4. Continue lifting the backrest latch while lowering the backrest to create the passenger seat (D).
5. Release the backrest latch and make sure the under-seat latch is fully engaged. If the seat can be lifted, repeat the procedure until the under-seat latch engages.
6. Lift the adjustment latch (E) at the top of the passenger backrest. Raise the backrest to the desired position. Release the latch, making sure it locks into one of the three operating positions.

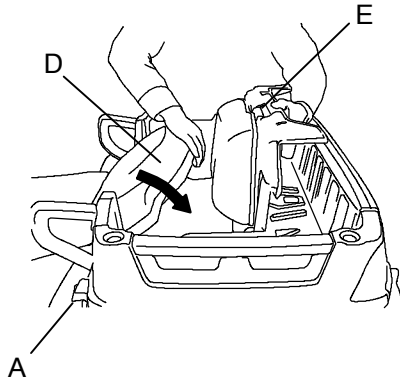

**NOTE:** The backrest must be moved out of the lowest position before it can be secured in the upright position. The lowest position is for seat storage only. Do not leave the backrest in the lowest position. Always adjust the backrest to one of the three operating positions.

7. Test the passenger seat lock-out by attempting to release the cargo box dump lever (A). If the dump lever releases, the seat is not secure. Repeat the set-up procedure.

**NOTE:** If the lock-out is not working properly, do not allow a passenger to ride the vehicle. See your Polaris dealer for service.

8. To return the vehicle to 1-up operation, reverse all steps. Be sure to lower the passenger backrest to the lowest position before folding it down into the cargo box. Make sure both backrests lock securely in place.



# FEATURES

## Instrument Cluster

Your ATV is equipped with an instrument cluster that senses vehicle speed from the right front wheel. The instrument cluster measures distance in miles or kilometers as well as hours of operation. It also includes a reverse speed limiter function that limits the ATV's speed to approximately 7-9 mph. Refer to page 36 for additional information.

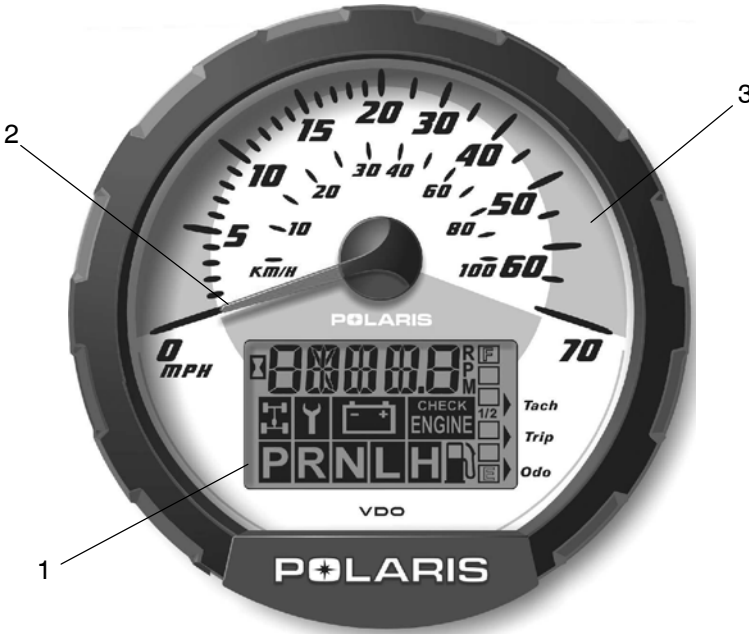

1. Rider Information Center
2. Speedometer needle - in addition to showing vehicle speed, the needle flashes when a warning condition exists.
3. Speedometer

## CAUTION

To prevent damage, wash the ATV by hand or with a garden hose using mild soap. Do not use alcohol to clean the instrument cluster. Immediately clean off any gasoline that splashes on the instrument cluster. Do not allow insect sprays to come into contact with the lens.

# FEATURES

## Instrument Cluster

### Rider Information Center

The rider information center is located in the instrument cluster. All segments will light up for 2.5 seconds at start-up.

**NOTE:** If the instrument cluster fails to illuminate, a battery over-voltage may have occurred and the instrument cluster may have shut off to protect the cluster's electrical system. If this occurs, take the ATV to your Polaris dealer for proper diagnosis.

1. **Gear Indicator** - As the shift lever is moved, this indicates the gear the transmission is in:

H = High Range

L = Low Range

N = Neutral

R = Reverse

P = Park

2. **AWD Indicator** - This indicator illuminates when the electrical portion of the AWD system is enabled.

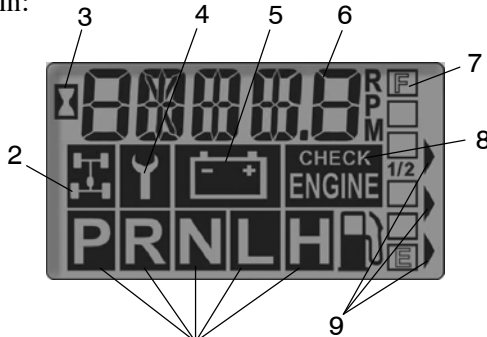

3. **Engine Hour Display Indicator**
4. **Service Interval/Diagnostic Mode Indicator**
5. **Low Battery or Over Voltage** - This warning usually indicates that the ATV is being operated at an RPM too low to keep the battery charged. A low battery warning may also occur under normal operation if the machine is at idle and high electrical load (lights, cooling fan, accessories) is applied. Driving at a higher RPM or connecting a battery charger will usually clear the warning.
6. **Odometer/Tachometer/Tripmeter/ Hour Meter**
7. **Fuel Gauge** - The segments of the fuel gauge show the level of fuel in the fuel tank. When the last segment clears, a low fuel warning is activated. All segments will flash, "FUEL" will display in the LCD, and the speedometer needle will blink. Refuel immediately.
8. **Check Engine Warning Indicator** - This indicator serves two purposes. The word HOT displays if the engine overheats. It also appears if an EFI-related fault occurs. Do not operate the ATV if this warning appears. Serious engine damage could result.
9. **Mode Indicator**

# FEATURES

## Instrument Cluster

### Rider Information Center

The rider information center has 4 standard modes:

Mode 1 - Odometer

Mode 2 - Tripmeter

Mode 3 - Total Service Hours

Mode 4 - Tachometer

The reverse override button on the left handlebar is also the *mode button*.

**NOTE:** If using the mode button to program the rider information center, or to toggle through the options, the machine cannot be in reverse.

### Mode 1 - Odometer

The odometer records the miles traveled by the ATV.

### Mode 2 -Trip Meter

The trip meter records the miles traveled by the ATV on each trip if it's reset before each trip. To reset the trip meter, select the trip meter mode. Press and hold the mode button (override button) until the total changes to 0.

**NOTE:** In the Rider Information Center, the trip meter display contains a decimal point, but the odometer displays without a decimal point.

### Mode 3 - Hour Meter

This mode logs the total hours the engine has been in operation.

### Mode 4 - Tachometer

The engine RPM is displayed digitally.

**NOTE:** Small fluctuations in the RPM from day to day may be normal because of changes in humidity, temperature, elevation and electrical loads.

## Instrument Cluster Rider Information Center

### Diagnostic Mode

The diagnostic mode is for informational purposes only. Please return your ATV to your dealer for all major repairs.

As long as the gauge is in the diagnostic mode, the wrench icon will remain lit.

To leave the diagnostic mode, turn the key switch off and on.

**NOTE:** Any movement of the tires will also take the machine out of the diagnostic mode.

To enter the diagnostics mode:

1. Turn the key switch off and wait 10 seconds.
2. Lock the parking brake.
3. Place the transmission in neutral.
4. Hold the mode/reverse override button and turn the key switch on.
5. Release the switch as soon as the display is activated.

The initial screen display refers to the software version installed in your ATV. This information is displayed briefly.

Use the mode/reverse override button to toggle through the diagnostic screens.

**Screen 1:** Battery voltage

**Screen 2:** Tachometer

**Screen 3:** AWD diagnostic

This gauge indicates whether or not current is flowing through the AWD coil (only on models with switchable AWD).

**Screen 4:** Gear circuit diagnostic

This screen displays the resistance value (in ohms) being read at the gear switch input of the gauge.

# FEATURES

## Instrument Cluster

### Rider Information Center

#### Diagnostic Mode

##### Screen 5: Programmable service interval

The purpose of the programmable service interval is to provide the consumer and dealer with a convenient reminder for routine maintenance. When your vehicle leaves the factory, this feature is set at 50 hours. You must enable the programmable service interval before it can be used.

Once the service interval mode is set with the hours when service is due, the hours of actual engine operation are subtracted from the set hours until 0 is reached. When the counter reaches 0, the wrench icon will flash quickly for 5 seconds each time the vehicle is started as a reminder that the periodic maintenance is due.

To set the hours, press and hold the mode/override button until the wrench icon flashes. When it begins to flash, release the button. The setting will increase by one hour each time the button is pressed. Pressing and holding the button will allow the numbers to escalate much faster. When the desired time increment is displayed, release the button and wait for the wrench to stop flashing. When the wrench stops blinking, your service hours are set.

**NOTE:** If you scroll past the intended number, hold the button down until the count turns over to 0. You can then reset the number.

If the service interval is enabled on your ATV and you wish to turn it off, toggle to the service interval mode. Press and hold the mode button for approximately 7 seconds until the word *OFF* appears in the Rider Information Center.

##### Screen 6: Miles/Kilometers toggle

The display in the tripmeter and odometer can be changed to display either kilometers or miles. The current display mode will be shown as KM or MP. To change, hold in the mode button until the letters flash, then press and release the button once. When the display stops flashing, the mode has been set.

## Instrument Cluster Rider Information Center

### Special EFI Diagnostic Mode

The EFI diagnostic mode is for informational purposes only. Please see your Polaris dealer for all major repairs. To download blink codes (failure codes) from the EFI module:

1. Place the transmission in PARK. Turn the engine off and turn the key switch to the ON position.
2. Turn the key switch off and on three times in less than five seconds, then leave the switch on. Any blink code numbers stored in the EFI module will display, one at a time, in the alphanumeric display. The number “61” and the word “END” will display after all codes have been transmitted.

Blink Code	Failure Description	Blink Code	Failure Description
-	No RPM Signal	54	Engine Temp Lamp: Open Load
21	Loss of Synchronization	54	Engine Temp Lamp: Short Circuit to Ground
45	Barometric Pressure Sensor: Circuit Low Input	54	Engine Temp Lamp: Short Circuit to Battery
46	Barometric Pressure Sensor: Circuit High Input	55	Diag Lamp: Open Load
22	TPS: Open or Short Circuit to Ground	55	Diag Lamp: Short Circuit to Ground
22	TPS: Short Circuit to Battery	55	Diag Lamp: Short Circuit to Battery
23	RAM Error: Defective ECU	56	Pump Relay: Open Load
42	Engine Temp Sensor Circuit: Short to Ground	56	Pump Relay: Short Circuit to Ground
42	Engine Temp Sensor Circuit: Open or Short to Battery	56	Pump Relay: Short Circuit to Battery
51	Injector 1: Open Load	41	Intake Air Temp Sensor: Open or Short Circuit to +Sensor Voltage
51	Injector 1: Short Circuit to Ground	41	Intake Air Temp Sensor: Short Circuit to Ground
51	Injector 1: Short Circuit to Battery	61	END
52	Injector 2: Open Load		
52	Injector 2: Short Circuit to Ground		
52	Injector 2: Short Circuit to Battery		

# OPERATION

## Fuel Safety

### **WARNING**

Gasoline is highly flammable and explosive under certain conditions.

- Always exercise extreme caution whenever handling gasoline.
- Always refuel with the engine stopped, and outdoors or in a well ventilated area.
- Never fill a gas container while it's in the cargo box. Static electricity between the box and container could cause a spark.
- Do not smoke or allow open flames or sparks in or near the area where refueling is performed or where gasoline is stored.
- Do not overfill the tank. Do not fill the tank neck.
- If gasoline spills on your skin or clothing, immediately wash it off with soap and water and change clothing.
- Never start the engine or let it run in an enclosed area.  
Engine exhaust fumes are poisonous and can cause loss of consciousness or death in a short time.

### **WARNING**

The engine exhaust from this product contains chemicals known to cause cancer, birth defects or other reproductive harm.

Operate this vehicle only outdoors or in well-ventilated areas.

## Break-In Period

The break-in period for your new Polaris ATV is the first ten hours of operation, or the time it takes to use the first two full tanks of gasoline. No single action on your part is as important as following the procedures for a proper break-in. Careful treatment of a new engine and drive components will result in more efficient performance and longer life for these components.

## CAUTION

Excessive heat build-up during the first three hours of operation will damage close-fitted engine parts and drive components. Do not operate at full throttle or high speeds during the first three hours of use.

## Engine and Drivetrain Break-in

1. Fill the fuel tank with gasoline. See page 42.
2. Check the oil reservoir level on the dipstick. See page 81. Add oil if necessary to maintain the level between the safe and add marks.
3. Drive slowly at first. Select an open area that allows room to familiarize yourself with vehicle operation and handling.
4. Vary the throttle positions. Do not operate at sustained idle.
5. Perform regular checks on fluid levels, controls and areas outlined on the daily pre-ride inspection checklist. See page 54.
6. Pull only light loads.
7. During the break-in period, change both the oil and the filter at 20 hours, 200 miles, or one month, whichever comes first.

## PVT Break-in (Clutches/Belt)

A proper break-in of the clutches and drive belt will ensure a longer life and better performance. Break in the clutches and belt by operating at slower speeds during the break-in period as recommended. Pull only light loads. Avoid aggressive acceleration and high speed operation during the break-in period.



# OPERATION

## Pre-Ride Inspection

### WARNING

If a proper inspection is not done before each use, severe injury or death could result. Always inspect the vehicle before each use to ensure it's in proper operating condition.

Pre-Ride Checklist		
Item	Remarks	See Page
Passenger seat lock-out	Ensure proper operation	44
Brake system / lever travel	Ensure proper operation	38, 90
Brake fluid	Ensure proper level	39
Auxiliary brake	Ensure proper operation	41
Front suspension	Inspect, lubricate if necessary	79
Rear suspension	Inspect, lubricate if necessary	79
Steering	Ensure free operation	-
Tires	Inspect condition and pressure	94
Wheels / fasteners	Inspect, ensure fastener tightness	95
Frame nuts, bolts, fasteners	Inspect, ensure tightness	-
Fuel and oil	Ensure proper levels	81
Coolant level (if applicable)	Ensure proper level	-
Coolant hoses (if applicable)	Inspect for leaks	-
Throttle	Ensure proper operation	37, 116
Indicator lights / switches	Ensure operation	38
Engine stop switch	Ensure proper operation	36
Air filter, pre-filter	Inspect, clean	96
Air box sediment tube	Drain deposits whenever visible	-
Headlamp	Check operation, apply Polaris dielectric grease when lamp is replaced	97
Brake light / tail lamp	Check operation, apply Polaris dielectric grease when lamp is replaced	100
Riding gear	Wear helmet, goggles, protective clothing	13

## Starting the Engine

### **WARNING**

Engine exhaust contains poisonous carbon monoxide and can cause loss of consciousness resulting in severe injury or death. Never run an engine in an enclosed area.

1. Position the vehicle on a level surface.
2. Place the transmission in *PARK*.
3. Lock the parking brake.
4. Sit on the vehicle and turn the engine stop switch to *RUN*.

**NOTE:** Do not press the throttle while starting the engine.

5. Turn the ignition key past the *ON* position to engage the starter. Activate the starter for a maximum of five seconds, releasing the key when the vehicle starts. If the engine does not start, return the key to the *OFF* position and wait five seconds before attempting to start again. Activate the starter for another five seconds if necessary. Repeat this procedure until the engine starts.

### **CAUTION**

Operating the vehicle immediately after starting could cause engine damage. Allow the engine to warm up for several minutes before operating the vehicle.

## **Cold Weather Operation**

If the ATV is used year-round, check the oil level frequently. A rising oil level could indicate the accumulation of contaminants such as water or excess fuel in the bottom of the oil tank. Water in the bottom of the tank can lead to engine damage and must be drained. Water accumulation increases as outside temperature decreases.

See your Polaris dealer for engine heater kits, which provide quicker warm-ups and easier starting in colder weather.

# OPERATION

## Driving Procedures

1. Wear appropriate riding gear. See page 13.
2. Perform the pre-ride inspection. See page 54.
3. Place the transmission in PARK.
4. Lock the parking brake.
5. Mount the vehicle from the left side.
6. Sit upright with both feet on the footrests and both hands on the handlebars.
7. Start the engine and allow it to warm up, then shift the transmission into gear.
8. Check your surroundings and determine your path of travel.
9. Shift the transmission into gear.
10. Release the parking brake.
11. Slowly depress the throttle with your right thumb and begin driving.
12. Drive slowly. Practice maneuvering and using the throttle and brakes on level surfaces.



# OPERATION

## Making Turns

Both rear wheels drive equally at all times, except when operating in TURF mode. This means that the outside wheel must travel a greater distance than the inside wheel when turning, and the inside tire must slip traction slightly.



1. Slow down.
2. Never turn quickly when carrying a passenger or cargo.
3. Steer in the direction of the turn.
4. Keep both feet on the footrests.
5. Lean your upper body to the inside of the turn while supporting your weight on the outer footrest.

**NOTE:** This technique alters the balance of traction between the rear wheels, allowing the turn to be made smoothly.

6. The same leaning technique should be used for turning in reverse.

**NOTE:** Practice making turns at slow speeds before attempting to turn at faster speeds.

## WARNING

Turning at sharp angles or at excessive speeds can result in vehicle overturn and lead to serious injury. Avoid turning at sharp angles. Never turn at high speeds.

# OPERATION

## Driving with a Passenger

1. Make sure the passenger is at least 12 years of age and is tall enough to comfortably reach the footrests and grab handles.
2. Make sure the passenger is wearing appropriate riding gear, including an approved helmet with a rigid chin guard. See page 13.
3. Perform the pre-ride inspection. See page 54.
4. Convert the seat for 2-up riding. See page 44. Make sure the passenger seat lock-out is functioning properly.
5. Lock the parking brake.
6. Mount the vehicle from the left side. After the operator is seated, the passenger should mount the vehicle from the left side. Always make sure the brake is engaged to ensure the vehicle remains motionless whenever a passenger mounts or dismounts.
7. Allow a passenger to ride only in the approved passenger seat.
8. Do not carry more than one passenger.
9. Slow down. Control may be more difficult with a passenger on board. Allow more time and distance for braking.



## Driving with a Passenger

10. Ride to the ability of your passenger, instead of to your own ability. Avoid unexpected or aggressive maneuvers that could cause a passenger to fall from the vehicle.
11. Do not cross a hillside with a passenger on board. See page 62.
12. A passenger should always be seated in the passenger seat with both feet on the footrests and both hands on the passenger grab handles at all times. The passenger should never hold on to the operator.
13. Never secure a passenger to the vehicle or to the operator with a belt, rope or similar device.
14. Make sure the passenger understands the importance of “active riding.” When hill-climbing or performing maneuvers, a passenger should shift body weight in the same manner in which the driver shifts body weight. For example, the passenger should lean to the inside of a turn along with the operator and should always lean *uphill* when climbing and descending hills.

# OPERATION

## Driving on Slippery Surfaces

Whenever riding on slippery surfaces such as wet trails or loose gravel, or during freezing weather, follow these precautions:

1. Slow down when entering slippery areas.
2. Engage AWD before wheels begin to lose traction.
3. Maintain a high level of alertness, reading the trail and avoiding quick, sharp turns, which can cause skids.
4. Correct a skid by turning the handlebars in the direction of the skid and shifting your body weight forward.



## CAUTION

Severe damage to drive train may occur if the AWD is engaged while the wheels are spinning. Always allow the rear wheels to stop spinning before engaging AWD, or engage AWD before wheels begin to lose traction.

## WARNING

Failure to exercise care when operating on slippery surfaces can result in loss of tire traction and cause loss of control, accident, and serious injury or death.

Never apply the brakes during a skid. Do not operate on excessively slippery surfaces. Always reduce speed and use additional caution.

## Driving Uphill

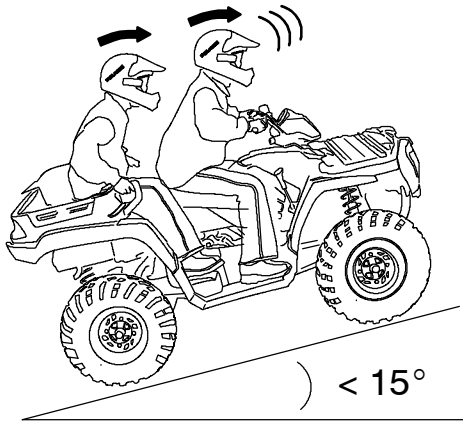

Whenever traveling uphill, follow these precautions:

1. Always travel straight uphill.
2. Avoid steep hills ( $15^\circ$  maximum).
3. Keep both feet on the footrests.
4. Shift body weight uphill.
5. Proceed at a steady rate of speed and throttle opening.
6. Remain alert and be prepared to take emergency action. This may include quick dismounting of the vehicle.
7. If the vehicle stalls while climbing a hill, never back it down the hill! Apply the hand brake. If a passenger is on board, ask the passenger to dismount. Use the K-turn to turn around. See page 64.

### **WARNING**

Braking and handling are greatly affected when operating in hilly terrain. Improper procedure could cause loss of control or overturn and result in serious injury or death.

Avoid climbing steep hills ( $15^\circ$  maximum).

Use extreme caution when operating on hills, and follow proper operating procedures outlined in the owner's manual.



# OPERATION

## Driving on a Hillside

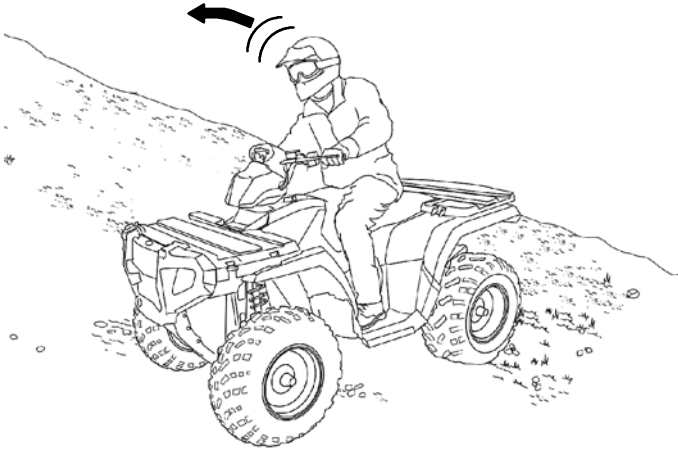

### **⚠ WARNING**

Improperly crossing hills or turning on hills can result in loss of control or vehicle overturn, resulting in severe injury or death. Avoid crossing the side of a hill when possible. Do not cross a hillside with a passenger on board. Follow proper procedures as outlined in the owner's manual.

Sidehilling can be the most dangerous type of driving encountered and should be avoided if at all possible. If you do enter into a situation where sidehilling is necessary, follow these precautions:

1. Slow down.
2. Do not cross a hillside with a passenger on board. Ask the passenger to dismount and walk across the hillside before remounting the vehicle.
3. Lean into the hill, transferring your upper body weight toward the hill while keeping your feet on the footrests.
4. Steer slightly into the hill to maintain vehicle direction.

**NOTE:** If the vehicle begins to tip, quickly turn the front wheel downhill, if possible, or dismount on the uphill side *immediately!*

## Driving Downhill

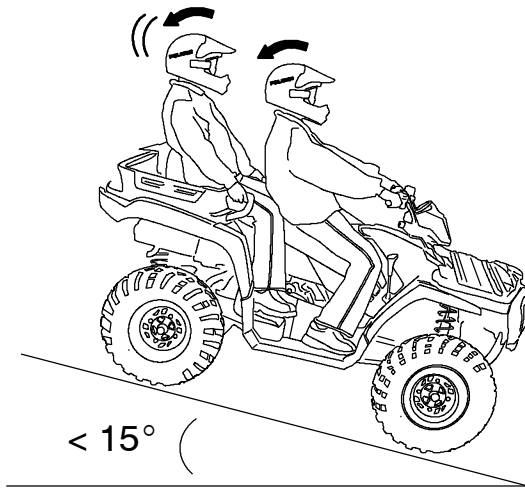

Whenever descending a hill, follow these precautions:

1. Always descend a hill with the transmission in forward gear. Do not descend a hill with the transmission in neutral.
2. Slow down.
3. Proceed directly downhill.
4. Shift body weight uphill.
5. Apply the brakes *slightly* to aid in slowing.

Familiarize yourself with operation of the auxiliary brake in the event loss of normal service brakes occurs.

### **WARNING**

Excessive speed can cause loss of control and lead to serious injury or death. Always operate slowly when traveling downhill.

# OPERATION

## Turning Around on a Hill

If the vehicle stalls while climbing a hill, never back it down the hill!  
Use the K-turn to turn around.

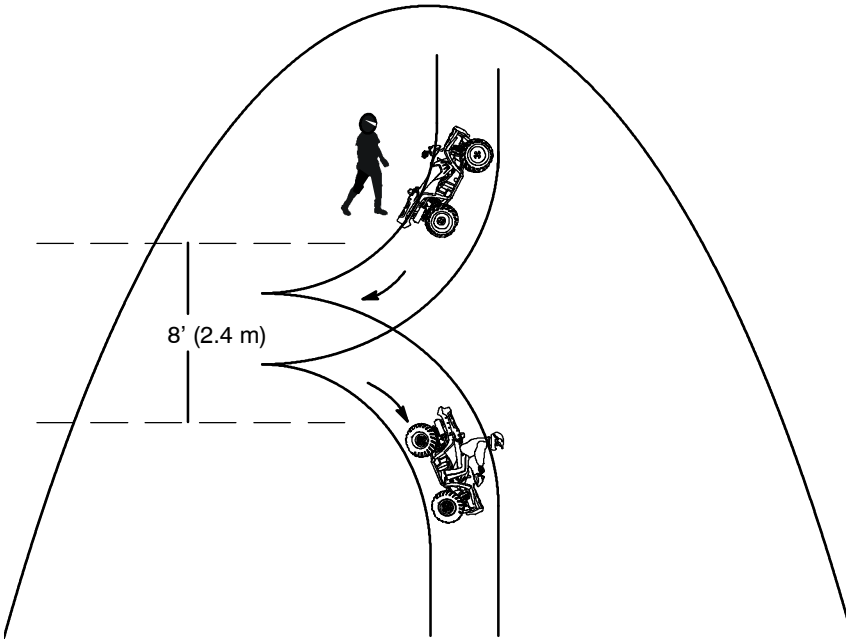

## Turning Around on a Hill

1. Stop the vehicle and lock the parking brake while keeping body weight uphill.
2. Leave the transmission in forward and shut off the engine.
3. Dismount on the uphill side of the vehicle, or on the left if the vehicle is pointing straight uphill.

**NOTE:** If a passenger is on board, ask the passenger to dismount first, then the operator may dismount.

4. Staying uphill of the vehicle, turn the handlebars full left.
5. While holding the service brake, release the parking brake lock and slowly allow the vehicle to roll around to your right until it's pointing across the hill or slightly downward.
6. Lock the parking brake and remount the vehicle from the uphill side, keeping body weight uphill.
7. Restart the engine with the transmission still in forward.
8. Release the parking brake and proceed *slowly*, controlling speed with the service brake, until the vehicle is on more level ground.

**NOTE:** A passenger should not remount until the vehicle returns to firm, level ground.

# OPERATION

## Driving Through Water

Your ATV can operate through water with a maximum recommended depth equal to the bottom of the footrests (1). Follow these procedures when operating through water:



1. Determine water depths and current before crossing.
2. Choose a crossing where both banks have gradual inclines.
3. Proceed slowly, avoiding rocks and obstacles if possible.
4. After crossing, dry the brakes by applying light pressure to the lever until braking action is normal.

After running the vehicle in water, it's *critical* to have it serviced as outlined in the maintenance chart. See page 74. The following areas need special attention: engine oil, transmission oil, front gearcase, and all grease fittings.

## Driving Through Water

### CAUTION

Major engine damage can result if the vehicle is not thoroughly inspected after operation in water. Perform the services outlined in the maintenance chart.

If your vehicle becomes immersed or is operated in water that exceeds the footrest level, take it to your dealer for service before starting the engine.

**NOTE:** Avoid operating the vehicle through deep or fast-flowing water. If you cannot avoid water that exceeds the recommended maximum depth, go slowly, balance your weight carefully, avoid sudden movements, and maintain a slow and steady forward motion. Do not make sudden turns or stops, and do not make sudden throttle changes.

If your vehicle becomes immersed, and it's impossible to take it to a dealer before starting it, follow the steps described on page 102. Have the vehicle serviced by your dealer at the first opportunity.

# OPERATION

## Driving in Reverse

Follow these precautions when operating in reverse:

1. Always avoid backing downhill.
2. Always check for obstacles or people behind the ATV before operating in reverse. Be aware that a passenger can obstruct your view.
3. When it's safe to proceed in reverse, move slowly and avoid turning at sharp angles.
4. When in reverse, apply the brakes *lightly* for stopping.
5. Never open the throttle suddenly while backing.



## **⚠** WARNING

Failure to use caution when operating in reverse can result in serious injury or death. Before shifting into reverse, always check for obstacles or people behind the vehicle. When it's safe to proceed, back slowly.

Do not use the override switch unless additional power is required for vehicle movement. Use with caution.

Avoid backing on inclines, and avoid turning at sharp angles.

**NOTE:** Your Polaris ATV is equipped with a reverse speed limiter. The override button should be used with caution as rearward vehicle speed is greatly increased. Do not operate at wide open throttle. Open the throttle just enough to maintain a desired speed.

## CAUTION

Excessive throttle operation while in the speed limit mode may cause fuel to build in the exhaust, resulting in engine popping and/or engine damage.

# OPERATION

## Driving Over Obstacles

1. Be alert! Look ahead and learn to read the terrain you're traveling on. Be constantly alert for hazards such as logs, rocks and low hanging branches.
2. Avoid operating over large obstacles such as rocks and fallen trees when possible. If unavoidable, use extreme caution.
3. Always have a passenger dismount before operating over an obstacle that could cause a fall from the vehicle or vehicle tipover.

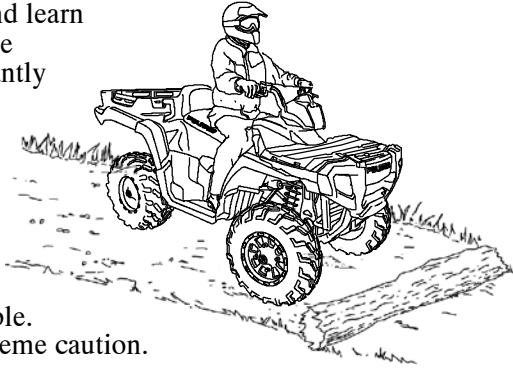

## WARNING

Severe injury or death can result if your vehicle comes in contact with a hidden obstacle. Not all obstacles are immediately visible. Travel with caution in unfamiliar terrain.

## Parking on an Incline

Avoid parking on an incline if possible. If it's unavoidable, follow these precautions:

1. Turn the engine off.
2. Place the transmission in PARK.
3. Lock the parking brake.
4. Always block the rear wheels on the downhill side as shown in the illustration.

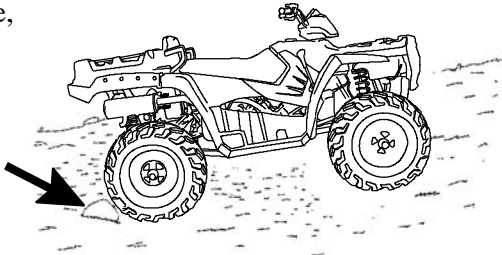



# OPERATION

## Hauling Cargo

### **WARNING**

Overloading the vehicle or carrying or towing cargo improperly can alter vehicle handling and may cause loss of control or brake instability. Always follow these precautions when hauling cargo:

- Never exceed the stated load capacity for this vehicle.
- Never carry cargo in the rear box when operating the ATV in the 2-up mode with a passenger.
- Reduce speed and allow a greater distance for braking.
- When operating over rough or hilly terrain, reduce speed *and cargo* to maintain stable driving conditions.
- **WEIGHT DISTRIBUTION** in the cargo bed should be as far forward and as low as possible. Carrying a high load raises the center of gravity and creates a less stable operating condition. Reduce load weight when cargo is high. When handling off-centered loads that cannot be centered, secure the load and operate with extra caution.
- **ALL LOADS MUST BE SECURED BEFORE OPERATING.** Unsecured loads may shift and create unstable operating conditions, which could result in loss of control of the vehicle. Always be sure that the cargo bed is lowered and latched before moving the vehicle.
- **EXTREME CAUTION MUST BE USED** when operating with loads extending beyond the rack or cargo bed. Stability and maneuverability may be adversely affected, causing the machine to overturn.
- Carrying a load on only the front rack or cargo bed may cause an imbalanced condition and increases the possibility of vehicle overturn. Balance loads proportionally between the front rack and cargo bed, but do not exceed the stated load capacity.
- Use extreme caution when applying brakes with a loaded vehicle. Avoid terrain or situations that may require backing downhill.
- Always attach the tow load to the hitch point.
- The vehicle should never exceed 10 mph (16 kph) while towing a load on a level surface. Vehicle speed should never exceed 5 mph (8 kph) when towing loads in rough terrain, while cornering, or while ascending or descending a hill.
- Do not obstruct the headlight when loading the front rack.

# OPERATION

## Hauling Cargo Load Distribution

Your ATV has been designed to carry or tow a certain amount of load. Always read and understand the load distribution warnings listed on the warning labels, and never exceed the specified weights.

Cargo weight should be mounted as low as possible. When operating over rough or hilly terrain, reduce speed and cargo to maintain stable driving conditions.

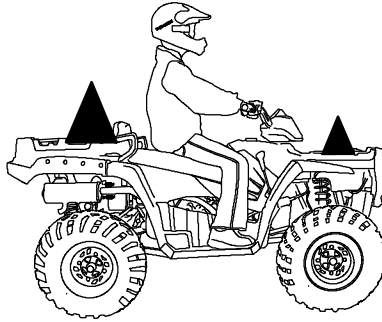

1. Always load the cargo box with the load as far forward as possible.
2. Always operate the vehicle with extreme caution whenever hauling or towing loads. Balance, handling, and control may be affected.
3. Slow down.
4. Make sure the cargo box dump latch is securely latched before loading and operating. Unintentional dumping will result if weight is placed in the rear of the box and the latch is not secured.

## Maximum Towing Capacities

Do not exceed the following maximum capacities when towing. Avoid towing on inclines.

	<b>Towing Load (Level Ground)</b>	<b>Vertical Hitch Weight</b>
<b>Sportsman X2 500 EFI</b>	1225 lbs. ( 556 kg)	120 lbs. (54.4 kg)

## Belt Life

Use low forward gear when hauling or towing heavy cargo to extend belt life.

# OPERATION

## Hauling Cargo

### Dumping Cargo

1. Select a level site to dump the cargo box. Do not attempt to dump or unload the vehicle while parked on an incline.
2. Place the transmission in PARK.
3. Lock the parking brake.
4. Dismount the vehicle.
5. Lower the tailgate.

### WARNING

If cargo weight is placed toward the rear of the cargo box, the load may dump unexpectedly and cause serious injury. When loading cargo, always position the weight as far forward and as low as possible.

6. Pull the cargo box release lever (A) upward.
7. Lift the front of the cargo box and dump the cargo.
8. Lower the cargo box and make sure the release latch is secured.
9. Secure the tailgate.

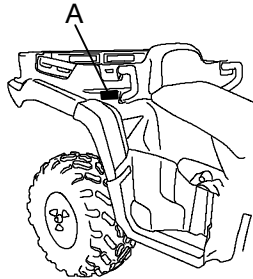

### WARNING

Operating with the cargo box in the raised position can cause serious injury and damage to the vehicle. The cargo box could close unexpectedly and injure the driver. The rear tires will also catch the rear of the bed, damaging the vehicle and creating hazardous driving conditions.

Never operate this vehicle with the cargo box in the raised position.

# **EMISSION CONTROL SYSTEMS**

## **Noise Emission Control System**

Do not modify the engine, intake or exhaust components, as doing so may affect compliance with U.S.A. EPA noise control requirements (40 CFR 205) and local noise level requirements.

## **Operation on Public Lands in the U.S.A.**

Your Polaris vehicle has a spark arrestor that was tested and qualified to be in accordance with the USDA Forest Service Standard 5100-1C. Federal law requires that this spark arrestor be installed and functional when the vehicle is operated on public lands.

Operation of off-road vehicles on public lands in the U.S.A. is regulated by 43 CFR 8343. Violations are subject to monetary penalties. Federal regulations can be viewed online at [www.gpoaccess.gov/ecfr/](http://www.gpoaccess.gov/ecfr/).

## **Crankcase Emission Control System**

This engine is equipped with a closed crankcase system. Blow-by gases are forced back to the combustion chamber by the intake system. All exhaust gases exit through the exhaust system.

## **Exhaust Emission Control System**

Exhaust emissions are controlled by engine design. An electronic fuel injection (EFI) system controls fuel delivery. The engine and EFI components are set at the factory for optimal performance and are not adjustable.

The emissions label is located on the recoil cover or stator housing.

## **Electromagnetic Interference**

This spark ignition system complies with Canadian ICES-002.

This vehicle complies with European directives 97/24/EC and 89/336/EEC.

# MAINTENANCE

## Periodic Maintenance Chart

Careful periodic maintenance will help keep your vehicle in the safest, most reliable condition. Inspection, adjustment and lubrication of important components are explained in the periodic maintenance chart.

Inspect, clean, lubricate, adjust and replace parts as necessary. When inspection reveals the need for replacement parts, use genuine Polaris parts available from your Polaris dealer.

Record maintenance and service in the Maintenance Log beginning on page 130.

**NOTE:** Service and adjustments are critical. If you're not familiar with safe service and adjustment procedures, have a qualified dealer perform these operations.

Maintenance intervals in the following chart are based upon average riding conditions and an average vehicle speed of approximately 10 miles per hour. Vehicles subjected to severe use must be inspected and serviced more frequently.

### Severe Use Definition

- Frequent immersion in mud, water or sand
- Racing or race-style high RPM use
- Prolonged low speed, heavy load operation
- Extended idle
- Short trip cold weather operation

Pay special attention to the oil level. A rise in oil level during cold weather can indicate contaminants collecting in the oil sump or crankcase. Change oil immediately if the oil level begins to rise. Monitor the oil level, and if it continues to rise, discontinue use and determine the cause or see your dealer.

# MAINTENANCE

## Periodic Maintenance Chart

### Maintenance Chart Key

- ▶ Perform these procedures more frequently for vehicles subjected to severe use.
- E Emission-related service (Failure to conduct this maintenance will not void the emissions warranty but may affect emissions.)
- Have an authorized Polaris dealer perform these services.

### **WARNING**

Improperly performing the procedures marked with a ■ could result in component failure and lead to serious injury or death. Have an authorized Polaris dealer perform these services.

# MAINTENANCE

## Periodic Maintenance Chart

Perform all services at whichever maintenance interval is reached first.

	Item	Maintenance Interval (whichever comes first)			Remarks
		Hours	Calendar	Miles (Km)	
■	Steering	-	Pre-Ride	-	Make adjustments as needed. See Pre-Ride Checklist on page 54.
▶	Front suspension	-	Pre-Ride	-	
▶	Rear suspension	-	Pre-Ride	-	
	Tires	-	Pre-Ride	-	
▶	Brake fluid level	-	Pre-Ride	-	
▶	Brake lever travel	-	Pre-Ride	-	
	Brake system	-	Pre-Ride	-	
	Passenger seat lock-out	-	Pre-Ride	-	
	Wheels/fasteners	-	Pre-Ride	-	
	Frame fasteners	-	Pre-Ride	-	
▶	Engine oil level	-	Pre-Ride	-	
▶ E	Air filter, pre-filter	-	Daily	-	Inspect; clean often; replace as needed
▶	Air box sediment tube	-	Daily	-	Drain deposits when visible
	Coolant	-	Daily	-	Check level daily, change coolant every 2 years
	Headlamp/tail lamp/worklight	-	Daily	-	Check operation; apply dielectric grease if replacing
▶ E	Air filter, main element	-	Weekly	-	Inspect; replace as needed
	Recoil housing	-	Weekly	-	Drain water as needed, check often if operating in wet conditions
▶ ■	Brake pad wear	10 H	Monthly	100 (160)	Inspect periodically
	Battery	20 H	Monthly	200 (320)	Check terminals; clean; test
▶	Front gearcase oil	25 H	Monthly	250 (400)	Inspect level; change yearly
▶	Transmission oil	25 H	Monthly	250 (400)	Inspect level; change yearly
▶ E	Engine breather filter (if equipped)	25 H	Monthly	250 (400)	Inspect; clean if needed

# MAINTENANCE

## Periodic Maintenance Chart

Item		Maintenance Interval (whichever comes first)			Remarks
		Hours	Calendar	Miles (Km)	
▶	General lubrication	50 H	3 M	500 (800)	Lubricate all fittings, pivots, cables, etc.
■ E	Throttle Cable/ ETC Switch	50 H	6 M	500 (800)	Inspect; adjust; lubricate; replace if necessary
E	Throttle Body In- take Duct	50 H	6 M	500 (800)	Inspect duct for proper seal- ing/air leaks
	Drive belt	50 H	6 M	500 (800)	Inspect; adjust; replace as needed
	Cooling system	50 H	6 M	1000 (1600)	Inspect coolant strength seasonally; pressure test system yearly
▶	Engine oil change	100 H	6 M	1000 (1600)	Perform a break-in oil change at one month
▶	Oil filter change	100 H	6 M	1000 (1600)	Replace with oil change
▶	Oil tank vent hose (if equipped)	100 H	12 M	1000 (1600)	Inspect routing, condition
■ E	Valve clearance	100 H	12 M	1000 (1600)	Inspect; adjust
■ E	Fuel system/filter	100 H	12 M	1000 (1600)	Check for leaks at tank cap, lines, filter, pump; replace lines every two years
▶	Radiator (if applicable)	100 H	12 M	1000 (1600)	Inspect; clean external surfaces
▶	Cooling hoses (if applicable)	100 H	12 M	1000 (1600)	Inspect for leaks
▶	Engine mounts	100 H	12 M	1000 (1600)	Inspect
	Exhaust muffler/ pipe	100 H	12 M	1000 (1600)	Inspect
■ E	Spark plug	100 H	12 M	1000 (1600)	Inspect; replace as needed
■ E	Ignition Timing	100 H	12 M	1000 (1600)	Inspect
▶	Wiring	100 H	12 M	1000 (1600)	Inspect for wear, routing, security; apply dielectric grease to connectors subjected to water, mud, etc.

- ▶ Perform these procedures more often for vehicles subjected to severe use.
- E Emission-Related Service
- Have an authorized Polaris dealer perform these services.



# MAINTENANCE

## Periodic Maintenance Chart

Item		Maintenance Interval (whichever comes first)			Remarks
		Hours	Calendar	Miles (Km)	
■	Clutches (drive and driven)	100 H	12 M	1000 (1600)	Inspect; clean; replace worn parts
■	Front wheel bearings	100 H	12 M	1000 (1600)	Inspect; replace as needed
■	Brake fluid	200 H	24 M	2000 (3200)	Change every two years
	Spark arrestor	300 H	36 M	3000 (4800)	Clean out
	Idle speed	-			Adjust as needed
■	Toe adjustment	-			Inspect periodically; adjust when parts are replaced
	Headlight aim	-			Adjust as needed

- ▶ Perform these procedures more often for vehicles subjected to severe use.
- E Emission-Related Service
- Have an authorized Polaris dealer perform these services.

# MAINTENANCE

## Lubrication Guide

Check and lubricate all components at the intervals outlined in the Periodic Maintenance Chart beginning on page 74. Items not listed in the chart should be lubricated at the General Lubrication interval.

### Lubrication Guide Key

- ▶ More often under severe use
- ★ Polaris Premium All Season Grease or grease conforming to NLGI No. 2, such as Conoco Superlube M or Mobilegrease Special
- Use Polaris Premium U-Joint Lube every 500 miles, before long periods of storage, or after pressure washing or submerging.

Item	Lube	Method
Engine Oil	Polaris Premium 4 Synthetic 0W40	See page 81.
Brake Fluid	DOT 3 Only	See page 39.
Transmission Oil	Polaris Premium AGL Synthetic Gearcase Lube	See page 85.
Front Demand Drive Unit (Front Gearcase)	Premium Demand Drive Hub Fluid	See page 87.
Front Prop Shaft Yoke (A)	● Grease	Grease fittings (3 pumps maximum).
Ball Joint (B)	▶★ Grease	Locate fitting and grease with grease gun.
Rear Bearing Carrier (C)	▶★ Grease	Locate fitting and grease with grease gun.

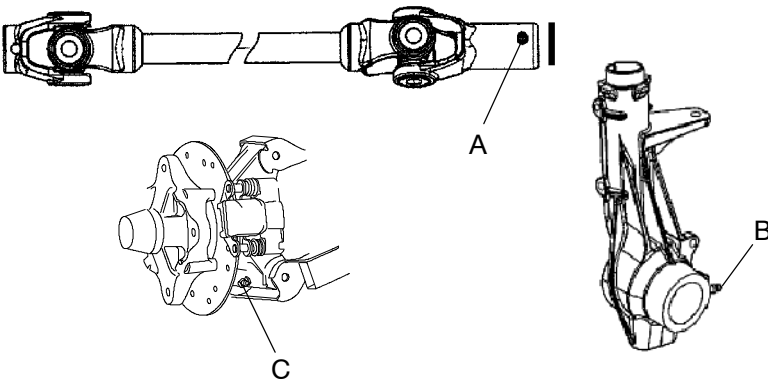

# MAINTENANCE

## Premium 4 Synthetic Lubricant

Polaris Premium 4 All Season synthetic engine oil has been specially formulated for use in Polaris 4-cycle engines. It's a fully synthetic, high performance, multi-viscosity oil designed to provide the ultimate in lubrication performance and protection.

**NOTE:** See page 117 for the part numbers of Polaris products.

Premium 4 possesses unsurpassed film strength over the widest possible temperature range. It resists viscosity and frictional breakdown in ambient temperatures from -40° F. to 120° F. (-40 to +49° C.) Its exceptional frictional properties result in more efficient operation, more power output and lower fuel consumption.

Although Polaris Premium 4 is the only oil recommended for use in this engine, use of any API certified *SH* oil is allowable as long as it's 0W-40. Oil may need to be changed more frequently if Polaris Premium 4 is not used. Follow the manufacturer's recommendations for ambient temperature operation.

## CAUTION

Mixing brands or using a non-recommended oil may cause serious engine damage. We recommend the use of Polaris Premium 4 synthetic Oil or another 0W-40 API certified *SH* oil. Never substitute or mix oil brands.

# MAINTENANCE

## Oil Level

The oil dipstick and fill tube (1) are located on the left side of the ATV.

**NOTE:** A rising oil level between checks in cool weather driving can indicate contaminants such as gas or moisture collecting in the crankcase. If the oil level is over the full/safe mark, change the oil immediately.

1. Position the vehicle on a level surface.
2. Start the engine and let it idle for 20-30 seconds. Stop the engine.
3. Remove the dipstick and wipe it dry with a clean cloth.
4. Reinstall the dipstick completely.
5. Remove the dipstick and check the oil level. Maintain the oil level in the normal or safe range (2). Do not overfill.
6. Reinstall the dipstick securely.

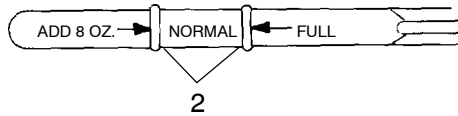
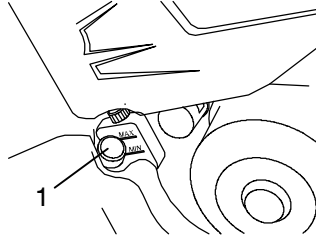

# MAINTENANCE

## Oil and Filter Change

Change the oil and filter at the intervals outlined in the Periodic Maintenance Chart beginning on page 74.

1. Position the vehicle on a level surface.
2. Clean the area around the drain plug at the bottom of the oil tank and the bottom of the engine.
3. Run the engine for two to three minutes, then turn it off.
4. Place a drain pan beneath the oil tank and remove the drain plug (1). Allow the oil to drain completely.
5. Install a new sealing washer (2) on the oil drain plug.

**NOTE:** The sealing surfaces on the drain plug and the oil tank should be clean and free of burrs, nicks or scratches.

6. Reinstall the drain plug.  
Torque to 14-17 ft. lbs.  
(19-23 Nm).
7. Disconnect the lower oil delivery hose and remove the screen fitting (3) from the oil tank. Clean the fitting.

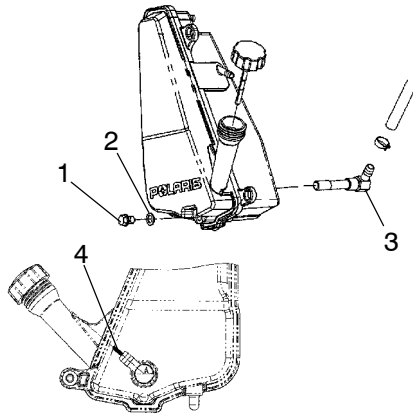

**NOTE:** The fitting threads must be sealed with LOCTITE PST 505 or PTFE seal tape.

8. Reinstall the screen fitting and rotate the fitting clockwise a minimum of 2 1/2 turns into the tank threads. Continue to rotate the fitting until the nipple of the fitting aligns with the mark (4) on the tank.

**NOTE:** Do not over-tighten. Maximum torque for the screen fitting is 25 ft. lbs. (34 Nm).

9. Reattach the oil line.

# MAINTENANCE

## Oil Change

10. Place shop towels beneath the oil filter. Using an oil filter wrench, turn the filter (1) counterclockwise and remove.
11. Lubricate the gasket on the new filter with a film of new engine oil. Check to make sure the gasket is in good condition. Also make sure the gasket from the old filter is not still on the engine.
12. Install the new filter and tighten by hand 1/2 to 3/4 turn after gasket contacts the engine.
13. Approximately one cup of engine oil will remain in the crankcase. To drain, remove the drain plug on the lower right side of the crankcase.

**NOTE:** The sealing surfaces on the drain plug and crankcase should be clean and free of burrs, nicks or scratches.

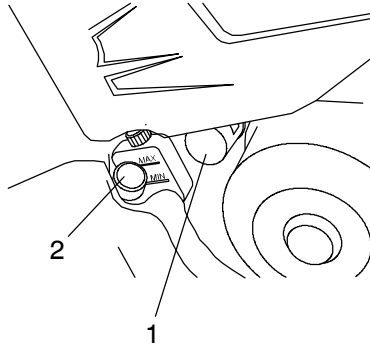

14. Reinstall the drain plug. Torque to 14 ft. lbs. (19 Nm).
15. Remove the dipstick (2) and add two quarts (1.9 l) of the recommended oil. Reinstall the dipstick.

**NOTE:** If the sump is not drained, add about 1 3/4 quarts (1.6 l) initially.

16. Place the transmission in neutral.
17. Lock the parking brake.
18. **Prime the oil pump using the procedure on page 84.** Then stop the engine and inspect for leaks.
19. Recheck the oil level on the dipstick and add oil as necessary to bring it to the recommended level on the dipstick.
20. Dispose of used filter and oil properly.

# MAINTENANCE

## Oil Change

### Oil Pump Priming

This priming procedure must be performed whenever the oil hose connection between the oil tank and pump inlet has been disconnected.

1. Clamp or pinch off the vent line (1) approximately 2" from the oil tank (2), between the end of the oil tank vent fitting and the vent line's pressure relief slit (3).
2. Run the engine for 10-20 seconds.
3. Remove the vent line clamp. If the line is bled properly, you should hear a rush of air, indicating that the line is properly primed and ready for operation. *If you do not hear air, the line has not bled, and you'll need to repeat the priming procedure.*

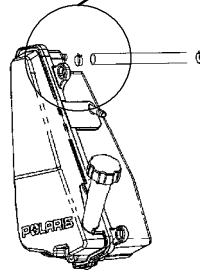
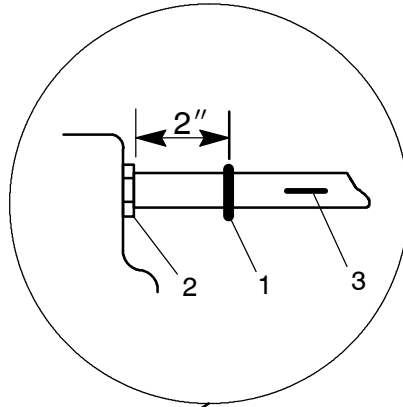

# MAINTENANCE

## Transmission Oil

Always check and change the transmission oil at the intervals outlined in the Periodic Maintenance Chart beginning on page 74. We recommend the use of Polaris Premium AGL Synthetic Gearcase Lubricant. See page 117 for the part numbers of Polaris products.

### Oil Check

The transmission fill plug (1) is located on the left side of the ATV, under the rear fender, behind the wheel.

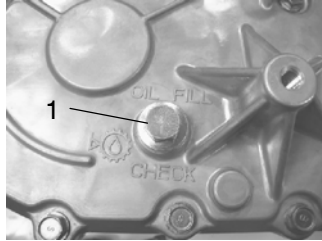
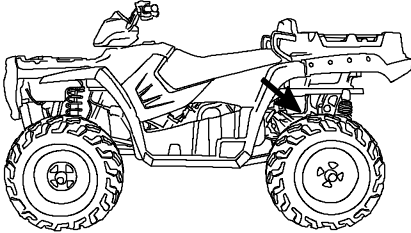

1. Position the vehicle on a level surface.
2. Remove the fill plug.
3. Add the recommended oil as needed to bring the level to the bottom of the fill plug hole threads.
4. Reinstall the fill plug. Torque to 20-25 ft. lbs. (27-34 Nm).



# MAINTENANCE

## Transmission Oil

### Oil Change

The transmission drain plug (2) is located on the right side of the gearcase, on the right side of the ATV, behind the wheel well.

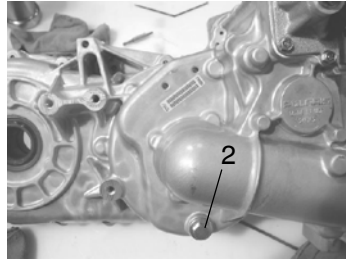
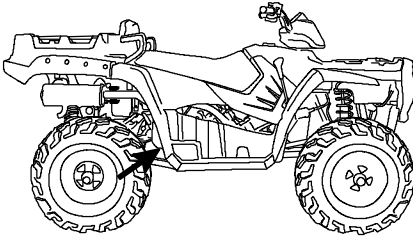

1. Remove the fill plug. Remove the drain plug.
2. Drain the oil into a drain pan. Dispose of used oil properly.
3. Clean and reinstall the drain plug. Torque to 20-25 ft. lbs. (27-34 Nm).
4. Add 32 oz. (948 ml) of the recommended transmission oil to bring the level to the bottom of the fill plug.
5. Reinstall the fill plug. Torque to 20-25 ft. lbs. (27-34 Nm).
6. Check for leaks.

# MAINTENANCE

## Front Gearcase Oil

Always check and change the front gearcase oil at the intervals outlined in the Periodic Maintenance Chart beginning on page 66. Maintain the oil level even with the bottom of the fill hole threads (1). We recommend the use of Polaris Premium Demand Drive Hub Fluid. Use of other oils may result in improper operation of components. See page 117 for the part numbers of Polaris products.

### Oil Check

1. Position the vehicle on a level surface.
2. Remove the fill plug (2). View the oil level.
3. Add the recommended gearcase oil as needed to bring the level to the bottom of the fill hole threads.
4. Reinstall the fill plug. Torque to 8-10 ft. lbs. (11-14 Nm).

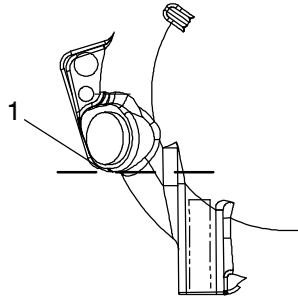

### Oil Change

1. Position the vehicle on a level surface.
2. Remove the fill plug.
3. Place a drain pan beneath the gearcase. Remove the gearcase drain plug (3) located on the bottom right-hand side.
4. Drain the oil. Dispose of used oil properly.
5. Clean and reinstall the drain plug. Torque to 11 ft. lbs. (15 Nm).
6. Add 6 ounces (175 ml) of Polaris Premium Demand Drive Hub Fluid.
7. Reinstall the fill plug. Torque to 8-10 ft. lbs. (11-14 Nm).
8. Check for leaks.

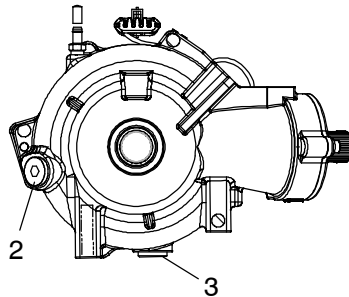

# MAINTENANCE

## Engine Cooling System

### Radiator Coolant Level

To ensure that the coolant maintains its ability to protect the engine, we recommend that the system be completely drained every two years and a fresh mixture of antifreeze and water added. Polaris recommends the use of Polaris Premium 60/40 anti-freeze/coolant or a 50/50 mixture of high quality aluminum compatible anti-freeze/coolant and distilled water. Polaris Premium 60/40 is already premixed and ready to use. Do not dilute with water. See page 117 for the part numbers of Polaris products.

**NOTE:** Always follow the manufacturer's mixing recommendations for the freeze protection required in your area.

Any time the cooling system has been drained for maintenance or repair, replace the coolant. If the recovery bottle has run dry, the level in the radiator should be inspected. Add coolant as needed.

### WARNING

Escaping steam can cause severe burns. Never remove the pressure cap while the engine is warm or hot. Always allow the engine to cool before removing the pressure cap.

1. To access the radiator pressure cap, open the front box lid and pull open the access door.
2. Remove the pressure cap (1).
3. Using a funnel, slowly add coolant through the radiator filler neck.
4. Reinstall the pressure cap, secure the access door and close the box.

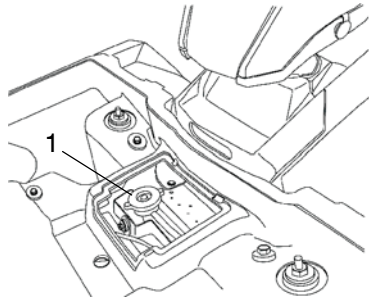

**NOTE:** Use of a non-standard pressure cap will not allow the recovery system to function properly. Contact your dealer for the correct replacement part.

## Engine Cooling System

### Coolant Level

The recovery bottle (1) is located on the left side of the machine. To access the recovery bottle, remove the left side panel as outlined on page 93.

Maintain the coolant level between the minimum and maximum marks on the bottle (when the fluid is cool). Add coolant as needed.

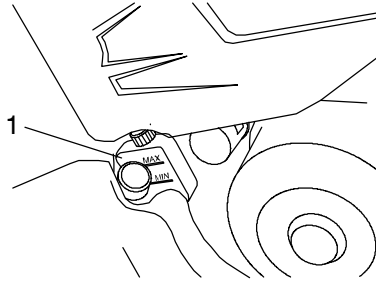

### Cooling System Operation

The engine coolant level is controlled or maintained by the recovery system. The recovery system components are the recovery bottle, radiator filler neck, radiator pressure cap and connecting hose.

As coolant operating temperature increases, the expanding (heated) excess coolant is forced out of the radiator, past the pressure cap, and into the recovery bottle. As engine coolant temperature decreases, the contracting (cooled) coolant is drawn back up from the tank, past the pressure cap, and into the radiator.

**NOTE:** Some coolant level drop on new machines is normal, as the system is purging itself of trapped air. Observe coolant levels and maintain as recommended by adding coolant to the recovery bottle.

# MAINTENANCE

## Brakes

The front and rear brakes are hydraulic disc brakes, activated by moving the single brake lever toward the handlebar. These brakes are self-adjusting.

The following checks are recommended to keep the brake system in good operating condition. Check more often if brakes are used heavily under normal operation.

### **WARNING**

Never store or use a partial bottle of brake fluid. Brake fluid is hygroscopic, meaning it rapidly absorbs moisture from the air. The moisture causes the boiling temperature of the brake fluid to drop, which can lead to early brake fade and the possibility of accident or severe injury. After opening a bottle of brake fluid, always discard any unused portion.

1. Always keep brake fluid at an adequate level (see page 39).

### **WARNING**

An over-full master cylinder may cause brake drag or brake lock-up, which could result in serious injury or death. Maintain brake fluid at the recommended level. Do not overfill.

**NOTE:** Under normal operation, the diaphragm extends into the reservoir as fluid level drops. If the fluid level is low and the diaphragm is not extended, a leak is likely and the diaphragm should be replaced. Always fill the reservoir as needed whenever the cover is loosened or removed to ensure proper diaphragm operation. Use Polaris DOT 3 brake fluid. Do not overfill.

# MAINTENANCE

## Brakes

2. Check the brake system for fluid leaks.
3. Check the brakes for excessive travel or spongy feel.
4. Check the friction pads for wear, damage and looseness.
5. Check the security and surface condition of the disc.

**NOTE:** Pads should be changed when worn to  $3/64''$  (.1 cm).

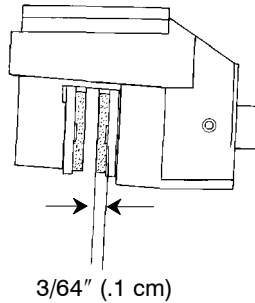

## Auxiliary Brake

The auxiliary brake system is intended to be used as a backup for the main brake system. Should the main system fail, the rear brake can be activated by depressing the foot pedal on the inside of the right footrest. The hydraulic auxiliary brake system requires no adjustment.

**NOTE:** Since this is a rear brake only, it will not be as effective as the all-wheel single lever system.

# MAINTENANCE

## Steering Assembly

The steering assembly of the ATV should be checked periodically for loose nuts and bolts. If loose nuts and bolts are found, see your Polaris dealer for service before operating the vehicle.

### Toe Alignment

#### **⚠ WARNING**

Severe injury or death can result from improper toe alignment and adjustment. Do not attempt to adjust tie rod alignment. All tie rod adjustments should be performed by an authorized Polaris dealer.

Use the following procedure to check the toe alignment of the vehicle. The recommended toe alignment is 1/8" to 1/4" toe out.

1. Set the handlebars in a straight-ahead position.

**NOTE:** The steering frog can be used as an indicator of whether the handlebars are straight. The frog should always point straight back from the steering post.

2. Place stands (1) in front of the vehicle, perpendicular to the rear tires. See illustration.
3. Tie an elastic string around the stands, making sure the string just touches the side surface of the rear tires on each side of the vehicle and goes around the stands in front of the vehicle (2).
4. Measure the distance from the string to the rim at the front and rear of the front rim (3). Rear measurement should be 1/16" - 1/8" (.2 to .3 cm) more than the front measurement.

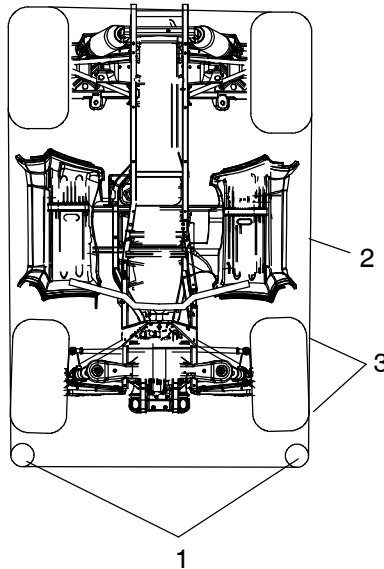

**NOTE:** If you discover improper alignment, see your Polaris dealer for service.

# MAINTENANCE

## Side Panel Removal

1. Remove the seat.
2. Grasp the rear of the side panel near the rear cab. With a firm motion, pull the panel outward to disengage the side panel from the grommet.
3. Pull the panel downward and rearward to remove it from the ATV.
4. Reinstall the side panel by reversing the removal procedure.

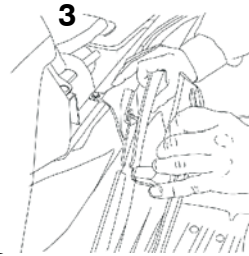
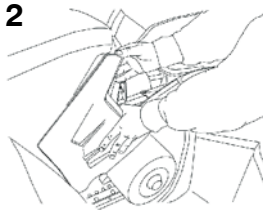
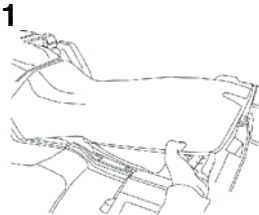

## Footwell Removal

1. Remove the six screws (1) on the bottom of the footwell.
2. Use a flat screwdriver or sidecutters to remove the four plastic rivets (2) securing the footwell to the fenders.
3. Remove the footwell.

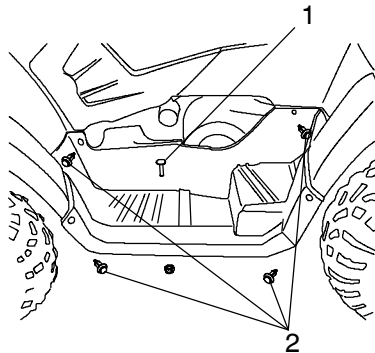



# MAINTENANCE

## **⚠ WARNING**

Operating your ATV with worn tires, improperly inflated tires, non-standard tires or improperly installed tires will affect vehicle handling and could cause an accident resulting in serious injury or death.

Maintain proper tire pressure as described on the decal on your ATV and in the owner's manual.

Always use original equipment size and type when replacing tires.

Make sure the wheels are installed properly.

Always replace tires when the tread depth measures 1/8" (.3 cm) or less.

## **Tire Tread Depth**

Always replace tires when tread depth is worn to 1/8" (.3 cm) or less. See illustration.

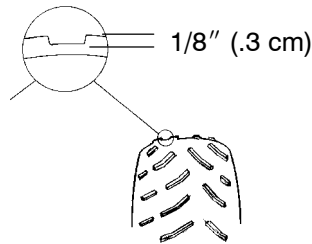

## **Front Wheel Hub Tightening**

Front wheel bearing tightness and spindle nut retention are critical component operations. All service must be performed by your authorized Polaris dealer.

## **Wheel Removal**

1. Stop the engine. Place the transmission in PARK.
2. Lock the parking brake.
3. Loosen the wheel nuts slightly.
4. Elevate the side of the vehicle by placing a suitable stand under the footrest frame.
5. Remove the wheel nuts and remove the wheel.

# MAINTENANCE

## Wheel Installation

### **⚠ WARNING**

Improperly installed wheels can adversely affect tire wear and vehicle handling, which can result in serious injury or death. Always ensure that all nuts are torqued to specification. Do not service axle nuts that have a cotter pin installed. See your Polaris dealer.

1. Place the transmission in PARK. Lock the parking brake.
2. Place the wheel on the wheel hub with the valve stem toward the outside and the rotation arrows on the tire pointing toward forward rotation.
3. Install the wheel nuts and finger tighten.
4. Lower the vehicle to the ground.
5. Torque the wheel nuts to specification.

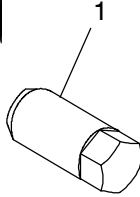

90 ft. lbs.  
(122 Nm)

**Cast Aluminum**

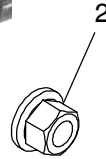

27 ft. lbs.  
(37 Nm)

**Steel**

## Wheel Nut Torque Specifications

Check the wheel nut torques occasionally and when they've been loosened for maintenance service.

Nut Type	Nut Torque
1. Lug Nut	90 ft. lbs. (122 Nm)
2. 2-Piece Flange Nut	27 ft. lbs. (37 Nm)

# MAINTENANCE

## Filter Systems

### Air Filter Service

1. Remove the seat, release the air box cover clips, and remove the air box cover.
2. Loosen the clamp and remove the filter.
3. Remove the fabric type pre-filter (1) from the main filter (2). Wash the pre-filter in soapy water, then rinse and let dry.
4. Reinstall the pre-filter over the main filter. (Replace the main filter if needed.)
5. Reinstall the filter into the air box and tighten the clamp. Do not over tighten the clamp, as filter damage could occur.
6. Reinstall the air box cover and the seat.

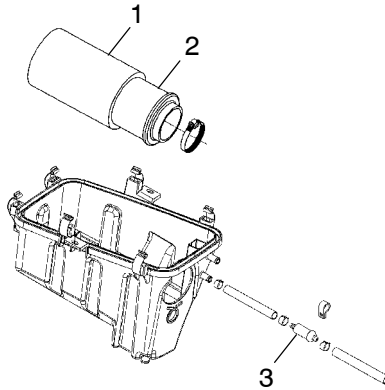

### Breather Filter/Hose

1. To access the breather filter (3), remove the left side panel as outlined on page 93. The breather filter is on the hose that runs between the engine and air box.
2. Remove the clamps and pull the filter out of the hoses.

**NOTE:** It's not necessary to remove the lower hose from the engine.

3. Inspect the filter for debris. Blow gently through the filter in the direction of the arrow to check for clogging. Replace if needed.
4. Check the hoses for cracks, deterioration, abrasion, or leaks. Replace as needed.
5. Reinstall the filter and secure the clamps.

**NOTE:** The filter is effective with the arrow pointing in either direction.

## CAUTION

Operation of your vehicle without a breather filter can cause engine damage. Always reinstall the breather filter after removing for service.

## Lights

When servicing a halogen lamp, don't touch the lamp with bare fingers. Oil from your skin leaves a residue, causing a hot spot that will shorten the life of the lamp.

### **WARNING**

Poor lighting while driving can result in severe injury or death. Headlight and taillight lenses become dirty during normal operation. Wash the headlights frequently to maintain lighting quality.

Hot components can cause serious burns to skin. Allow lamps to cool before servicing.

## Headlight Lamp Replacement

1. Remove the two screws on the lower front corners of the headlight pod.
2. Remove the screw from the rear of the pod.
3. Lift the pod slightly while depressing the tabs at the rear of the pod.
4. Lift the pod cover and disconnect the speedometer harnesses from the speedometer.
5. Unplug the headlamp from the wiring harness. Be sure to pull on the connector, not on the wiring.
6. Turn the lamp counterclockwise to remove it.
7. Apply dielectric grease to the socket and install the new lamp.

**NOTE:** Make sure the tab on the lamp locates properly in the housing.

8. Reassemble the pod.

# MAINTENANCE

## Lights

### High Beam Adjustment

The headlight beam can be adjusted slightly upward or downward. Use the following procedure to make the adjustment.

1. Position the vehicle on a level surface with the headlight approximately 25 ft. (7.6 m) from a wall.
2. Measure the distance from the floor to the center of the headlight and make a mark on the wall at the same height.
3. Start the engine and turn the headlight switch to high beam.
4. Observe the headlight aim on the wall. The most intense part of the headlight beam should be two inches (5.1 cm) below the mark on the wall.

**NOTE:** Include rider (and passenger) weight on the seat when measuring.

5. The adjustment knob is located on the right side of the headlight pod. Adjust the beam to the desired position by turning the knob either clockwise or counterclockwise.

### Low Beam Adjustment

The low beam can be adjusted slightly upward or downward.

1. Loosen the phillips screw (1) located at the rear of the headlamp.
2. Tilt the headlamp upward or downward.
3. Tighten the screw.

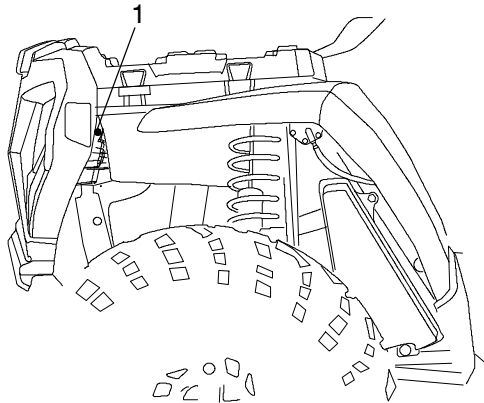

## Lights

### Headlight Housing Replacement

1. Remove the two screws on the lower front corners of the headlight pod.
2. Lift the pod slightly while depressing the tabs at the rear of the pod.
3. Lift the pod cover and disconnect the speedometer harnesses from the speedometer.
4. Unplug the headlamp from the wiring harness.
5. Use a small screwdriver to remove the o-rings from the headlight mounting tabs.
6. Pull the headlight housing up to release it from the locking tabs.
7. Lift the adjusting knob up to remove it from the locking tabs.
8. Carefully pull the assembly up and out of the pod.
9. Reverse the steps to install the new housing and reassemble the pod.

**NOTE:** The distance from the headlamp parting line to the end of the adjustment knob stop is 5 1/8" (13 cm).

10. Adjust the headlight aim by turning the adjusting knob.

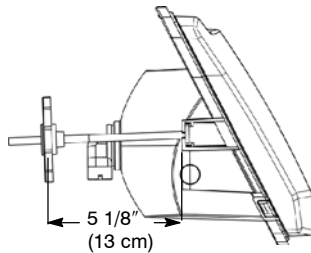

# MAINTENANCE

## Lights

### Lower Headlamp Removal / Installation

1. Turn the back of the headlight harness (1) counterclockwise and pull the harness assembly away from the headlight assembly.
2. Remove the headlamp and install the new headlamp.
3. Reinstall the harness assembly into the headlight assembly.
4. Turn the headlight harness clockwise to secure the headlamp.

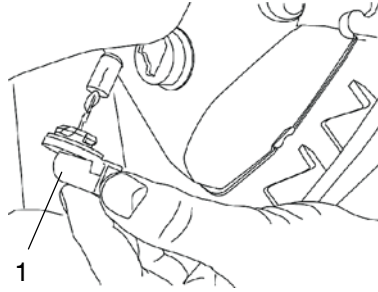

### Taillight/Brakelight/Worklight Lamp Replacement

1. Open the tailgate.
2. Remove the two screws(1) near the tailgate latch.
3. Grasp the entire taillight assembly and pull it away from the vehicle.
4. Remove the harness connector from the back of the light assembly.
5. Turn the lamp (2) counterclockwise to remove it.
6. Apply dielectric grease to the socket and install the new lamp.
7. Reinstall the harness connector.
8. Test the light for proper operation.
9. Reinstall the taillight assembly.
10. Reinstall the two screws.

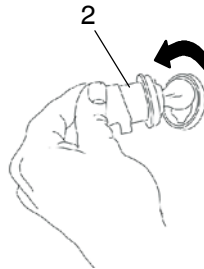
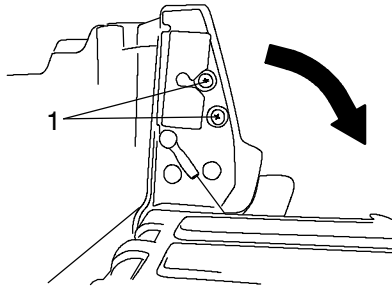

# MAINTENANCE

## Spark Plugs

Always use the spark plugs recommended for your ATV. Refer to the specifications section beginning on page 122 for the recommended spark plug type and gap.

### CAUTION

Using non-recommended spark plugs can result in serious engine damage. Always use Polaris-recommended spark plugs.

Spark plug condition is indicative of engine operation. The spark plug firing end condition should be read after the engine has been warmed up and the vehicle has been driven at higher speeds. Immediately check the spark plug for correct color.

### WARNING

A hot exhaust system and engine can cause serious burns. Wear protective gloves when removing a spark plug for inspection.

#### 1. Normal

The normal insulator tip is gray, tan or light brown. There will be few combustion deposits. The electrodes are not burned or eroded. This indicates the proper type and heat range for the engine and the service.

**NOTE:** The tip should not be white. A white insulator tip indicates overheating, caused by use of an improper spark plug or incorrect fuel.

#### 2. Wet Fouled

The wet fouled insulator tip is black. A damp oil film covers the firing end. There may be a carbon layer over the entire nose. Generally, the electrodes are not worn. General causes of fouling are excessive oil, use of non-recommended oil, or incorrect throttle body adjustments.

## Spark Plug Removal and Replacement

1. Remove the spark plug cap.
2. Using the special wrench provided in the tool pouch, rotate the spark plug counterclockwise to remove.
3. Reverse the procedure for spark plug installation, using the recommended spark plug. Torque to 18 ft. lbs. (24 Nm).



# MAINTENANCE

## Vehicle Immersion

### CAUTION

If your vehicle becomes immersed, major engine damage can result if the machine is not thoroughly inspected. Take the vehicle to your dealer before starting the engine.

If it's impossible to take your ATV to a dealer before starting it, follow the steps outlined below.

1. Move the ATV to dry land or at the very least, to water below the footrests.
2. Check the air box for any water and dry it if water is present.

**NOTE:** Filter replacement is required if water is present.

3. Remove the spark plug.
4. Turn the engine over several times using the electric start.
5. Dry the spark plug and reinstall, or replace it with a new plug.
6. Attempt to start the engine. If necessary, repeat the drying procedure.
7. Take the ATV to your dealer for service as soon as possible, whether you succeed in starting it or not.

**NOTE:** If water has been ingested into the PVT, follow the procedure on page 105 for drying out the PVT.

## Spark Arrestor

### **⚠ WARNING**

Failure to heed the following warnings while servicing the spark arrestor could result in serious injury or death.

Do not perform service on the spark arrestor while the system is hot. Exhaust system temperatures can reach 1000° F. Allow components to cool sufficiently before proceeding.

Remove any combustible materials from the area. Wear eye protection and leather work gloves. Do not stand behind or in front of the vehicle while purging. Never run the engine in an enclosed area. Exhaust contains poisonous carbon monoxide gas.

Never go under the vehicle while it's inclined.

1. Remove the arrestor clean-out plug (1) from the bottom of the muffler.
2. Place the transmission in PARK. Start the engine.
3. Purge carbon from the system by momentarily revving the engine several times.
4. If carbon is expelled, cover or plug the exhaust outlet (2) and rap on the pipe around the cleanout plug while revving the engine several more times.
5. If particles are still suspected to be in the muffler, elevate the rear of the vehicle one foot higher than the front. Lock the parking brake and block the wheels. Make sure the vehicle is in PARK and repeat steps 3 and 4 until no more particles are expelled when the engine is revved.
6. Stop the engine and allow the arrestor to cool. Reinstall the arrestor plug and remove the outlet cover or plug.

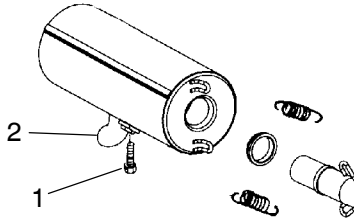

# MAINTENANCE

## PVT System

The basic operation of the Polaris PVT system is dependent on engine speed and vehicle torque requirements. As engine speed increases, the force exerted on the movable drive sheave by the flyweights also increases. This, in turn, increases the amount of *pinch* applied to the drive belt. Similarly, if the engine speed decreases, the amount of centrifugal force decreases, reducing the amount of belt pinch.

On Polaris ATVs, the approximate gear ratio difference between high and low range is 1:2.25. This difference in gearing affects the operation of the PVT, especially at speeds less than 7 MPH (11 KPH), due to the system's dependence on engine speed.

For example, when operating at a ground speed of 3 MPH (5 KPH) in low range, the engine speed would be around 3000 RPM. This is well above the engagement speed of 1200 - 1400 RPM. However, in high range at 3 MPH (5 KPH), the engine would be running at only 1500 RPM. Whenever operating this close to the engagement speed, the engine may be running at a speed too low to provide the pinch needed to prevent belt slip. Belt slip is responsible for creating the excessive heat that destroys belts and causes outer clutch covers to fail.

By switching to low range while operating at low ground speeds, the air temperature in the clutch cover is reduced by almost 160 degrees. Reducing the temperature inside the clutch cover extends the life of the PVT components (belt, cover, etc.).

### When To Use Low Range vs. High Range

Following is a guideline for when to use low range and high range.

#### Low Range

- When basic operation is at speeds less than 7 MPH (11 KPH)
- For heavy pulling
- When operating in rough terrain (swamps, mountains, etc.) at low ground speeds

#### High Range

- When basic operation is at speeds greater than 7 MPH (11 KPH)
- When operating at high ground speeds

## PVT System

### WARNING

Failure to comply with the instructions in this warning can result in severe injury or death.

Do not modify any component of the PVT system. Doing so may reduce its strength so that a failure may occur at a high speed. The PVT system has been precision balanced. Any modification will cause the system to be out of balance, creating vibration and additional loads on components.

The PVT system rotates at high speeds, creating large amounts of force on clutch components. Extensive engineering and testing has been conducted to ensure the safety of this product. However, as the owner, you have the following responsibilities to make sure this system remains safe:

Always follow all recommended maintenance procedures. See your dealer as outlined in the owner's manual.

This PVT system is intended for use on Polaris products only. Do not install it in any other product.

Always make sure the PVT housing is securely in place during operation.

## PVT Drying

There may be some instances when water is accidentally ingested into the PVT system. Use the following instructions to dry it out before operating:

1. Remove the drain plug and allow the water to drain. Replace the drain plug.
2. Start the engine and shift the transmission into neutral. Apply varying throttle for 10-15 seconds to expel the moisture and air-dry the belt and clutches. Do not hold the throttle wide open for more than 10 seconds.
3. Allow the engine RPM to settle to idle speed, then shift the transmission to the lowest available range.
4. Test for belt slippage. If the belt slips, repeat the process.
5. Take the vehicle to your dealer for service as soon as possible.

# MAINTENANCE

## Battery

Your ATV may have either a sealed battery, which requires little maintenance, or a conventional battery. A sealed battery can be identified by its flat covers on the top of the battery. A conventional battery has six filler caps on the top of the battery.

Always keep battery terminals and connections free of corrosion. If cleaning is necessary, remove corrosion with a stiff wire brush. Wash with a solution of one tablespoon baking soda and one cup water. Rinse well with tap water and dry off with clean shop towels. Coat the terminals with dielectric grease or petroleum jelly. Be careful not to allow cleaning solution or tap water into a conventional battery.

## WARNING

Battery electrolyte is poisonous. It contains sulfuric acid. Serious burns can result from contact with skin, eyes or clothing.

Antidote:

**External:** Flush with water.

**Internal:** Drink large quantities of water or milk. Follow with milk of magnesia, beaten egg, or vegetable oil. Call physician immediately.

**Eyes:** Flush with water for 15 minutes and get prompt medical attention.

Batteries produce explosive gases. Keep sparks, flame, cigarettes, etc. away. Ventilate when charging or using in an enclosed space. Always shield eyes when working near batteries. **KEEP OUT OF REACH OF CHILDREN.**

## Battery

### Battery Removal

1. Disconnect the hold-down strap holding the battery in position, and remove battery cover.
2. On conventional batteries, remove the battery vent tube.
3. Disconnect the black (negative) battery cable first.
4. Disconnect the red (positive) battery cable next.
5. Lift the battery out of the ATV. Be careful not to tip a conventional battery sideways, which could spill electrolyte.

### CAUTION

If electrolyte spills, immediately wash it off with a solution of one tablespoon baking soda and one cup water to prevent damage to the vehicle.

### Battery Installation

1. Set the battery in the battery holder.
2. With conventional batteries, install the battery vent tube (sealed batteries do not have a vent tube).

**NOTE:** The vent tube must be free of obstructions and securely installed. If not, battery gases could accumulate and cause an explosion. The tube should be routed away from the frame and body to prevent corrosion. Avoid skin contact with electrolyte, which can cause severe burns.

3. First connect and tighten the red (positive) cable.
4. Second connect and tighten the black (negative) cable.
5. Reinstall the battery cover and attach the hold-down strap.
6. Verify that cables are properly routed.

**NOTE:** When installing a new battery, make sure it's fully charged prior to its initial use. Using a new battery that has not been fully charged can damage the battery and result in a shorter life. It can also hinder vehicle performance.

# MAINTENANCE

## Battery

### Battery Storage

When the vehicle is placed in storage for three months or more, the battery should be removed, stored out of the sun in a cool, dry place and tested monthly. Before reusing, take the battery to your dealer for testing and recharging.

Power plug leads may need to be bent down so that the battery cover can be installed.

### Replenishing Battery Fluid (Conventional Battery)

A poorly maintained battery will deteriorate rapidly. Check the battery fluid level often. The fluid level should be kept between the upper and lower level marks (1).

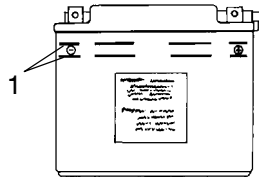

To refill use only distilled water. Tap water contains minerals that are harmful to a battery.

### WARNING

Improperly connecting or disconnecting battery cables can result in an explosion and cause serious injury or death. When removing the battery, always disconnect the negative (black) cable first. When reinstalling the battery, always connect the negative (black) cable last.

### Battery Charging (Sealed Battery)

The following battery charging instructions apply only to the installation of a YUASA activated, sealed battery. Read all instructions before proceeding with the installation of this battery.

The YUASA activated, sealed battery is already filled with electrolyte and has been sealed and *fully charged* at the factory. *Do not ever* pry the sealing strip off or add any other fluid to this battery.

The single most important thing to maintaining a sealed battery is to keep it fully charged. Since the battery is sealed and the sealing strip cannot be removed, you must use a voltmeter or multimeter to measure DC voltage.

# MAINTENANCE

## Battery

### Battery Charging (Sealed Battery)

For a refresh charge, follow all instructions carefully.

1. Check the battery voltage with a voltmeter or multimeter. A fully charged battery will register 12.8 V or higher.
2. If the voltage is less than 12.8 volts, recharge the battery.

**NOTE:** When using an automatic charger, refer to the charger manufacturer's instructions for recharging. When using a constant current charger, use the following guidelines for recharging.

### WARNING

An overheated battery could explode, causing severe injury or death. Always watch charging times carefully. Stop charging if the battery becomes very warm to the touch. Allow it to cool before resuming charging.

**NOTE:** Always verify battery condition before and 1-2 hours after the end of charging.

State of Charge	Voltage	Action	Charge Time* <small>(Using constant current charger @ standard amps specified on top of battery)</small>
100%	12.8-13.0 volts	None, check at 3 mos. from date of manufacture	None required
75%-100%	12.5-12.8 volts	May need slight charge, if no charge given, check in 3 months	3-6 hours
50%-75%	12.0-12.5 volts	Needs Charge	5-11 hours
25%-50%	11.5-12.0 volts	Needs Charge	At least 13 hours, verify state of charge
0%-25%	11.5 volts or less	Needs Charge	At least 20 hours



# MAINTENANCE

## Accessories

Auxiliary power outlets provide 12V power for operating accessories such as hand held spot lights. Accessory outlets are available for all models. Polaris also has a wide range of additional accessories available for your ATV. See your Polaris dealer.

## Cleaning and Storage

See page 117 for the part numbers of Polaris products.

## Washing the ATV

Keeping your ATV clean will not only improve its appearance but it can also extend the life of various components.

The best and safest way to clean your ATV is with a garden hose and a pail of mild soap and water. Use a professional type washing mitten, cleaning the upper body first and the lower parts last. Rinse with water frequently and dry with a chamois to prevent water spots. Avoid the use of harsh cleaners which can scratch the finish.

**NOTE:** If warning and safety labels are damaged, contact your Polaris dealer for free replacement.

## CAUTION

High water pressure may damage ATV components. Polaris recommends washing the ATV by hand or with a garden hose using mild soap.

Certain products, including insect repellants and chemicals, will damage plastic surfaces. Do not allow these types of products to come into contact with the ATV.

If a high pressure water system is used, exercise extreme caution to avoid damaging wheel bearings, radiator, transmission seals, body panels, brakes and warning labels. Grease all zerk fittings immediately after washing, and allow the vehicle to run for a while to evaporate any water that may have entered the engine or exhaust system.

## Waxing the ATV

Unless it has a special finish, your ATV can be waxed with any non-abrasive automotive paste wax. Do not wax models that have a camouflage finish.

# MAINTENANCE

## Cleaning and Storage

### Storage Tips

#### CAUTION

Starting the engine during the storage period will disturb the protective film created by fogging and damage could occur. Never start the engine during the storage period.

#### Clean the Exterior

Make necessary repairs and then clean the ATV thoroughly with mild soap and warm water to remove all dirt and grime. Don't use harsh detergents or high pressure washers. Some detergents deteriorate rubber parts. Use dish soap type cleaners only. High pressure washers may force water past seals.

#### Stabilize the Fuel

Fill the fuel tank. Add Polaris Carbon Clean Fuel Treatment or Polaris Fuel Stabilizer. Follow the instructions on the container for the recommended amount. (Carbon clean will also reduce the possibility of bacterial growth in the fuel system.) Allow 15-20 minutes of operation for the stabilizer to disperse through the fuel in the tank.

#### Oil and Filter

Warm the engine and change the oil and filter.

#### Air Filter / Air Box

Inspect and clean or replace the pre-cleaner and air filter. Clean the air box and drain the sediment tube.

#### Breather Filter

Inspect and clean or replace the breather filter.

#### Fluid Levels

Inspect the following fluid levels and change if necessary:

- Front demand drive unit (front gearcase)
- Transmission
- Brake fluid (change every two years or as required if fluid looks dark or contaminated)

# MAINTENANCE

## Cleaning and Storage

### Storage Tips

#### Fog the Engine

1. Treat the fuel system with Polaris Carbon Clean, following the instructions on the can. Run the engine for several minutes so the Carbon Clean reaches the injector. Turn the engine off.
2. Remove the spark plug and add 2-3 tablespoons of Premium 4 Synthetic 0W40 engine oil. To access the plug holes, use a section of clear 1/4" hose and a small plastic squeeze bottle filled with the pre-measured amount of oil.

**NOTE:** Do this carefully! If you miss the plug holes, oil will drain from the spark plug cavities into the hole at the front of the cylinder head, and appear to be an oil leak.

3. Reinstall the spark plug. Torque to 18 ft. lbs. (24 Nm).
4. Apply dielectric grease to the inside of the spark plug cap and reinstall the cap onto the plug.
5. Turn the engine over several times. Oil will be forced in and around the piston rings and ring lands, coating the cylinder with a protective film of fresh oil.
6. If Polaris fuel system additive is not used, the fuel tank, fuel lines, and injector should be completely drained of gasoline.

# MAINTENANCE

## Cleaning and Storage

### Storage Tips

#### Inspect and Lubricate

Inspect all cables and lubricate. Follow lubrication guidelines in the Maintenance Section of the service or owner's manual to completely grease and lubricate the entire vehicle with Polaris Premium All Season Grease.

#### Battery Maintenance (Conventional)

Remove the battery and add distilled water to the proper level. *Do not use tap water*, which may contain minerals that reduce battery life.

Apply dielectric grease to the terminal bolts and terminals. Charge the battery at 1.4 amps or less until the specific gravity of *each* cell is 1.265 or greater. Store the battery in a cool, dry place.

Charge can be maintained easily by using Polaris Battery Tender™ charger (PN 2871076) or by charging about once a month to make up for normal self-discharge. Battery Tender™ can be left connected during the storage period, and will automatically charge the battery if the voltage drops below a pre-determined point. Check the fluid level monthly.

#### Battery Maintenance (Sealed)

Remove the battery and recharge it as outlined on page 108. Store the battery in a cool, dry place.

#### Engine Anti-Freeze

Test engine coolant strength and change if necessary. Coolant should be replaced every two years.

#### Storage Area/Covers

Set the tire pressure and safely support the ATV with the tires 1-2" off the ground. Be sure the storage area is well ventilated, and cover the machine with a genuine Polaris ATV cover.

**NOTE:** Do not use plastic or coated materials. They do not allow enough ventilation to prevent condensation, and may promote corrosion and oxidation.

# MAINTENANCE

## Transporting the ATV

Follow these procedures when transporting the vehicle.

1. Turn off the engine and remove the key to prevent loss during transporting.
2. Place the transmission in PARK. Lock the parking brake.
3. Securely install the fuel cap, oil cap and seat.
4. Always tie the frame of the ATV to the transporting unit securely with suitable straps or rope. Do not attach tie straps to the front A-arm bolt pockets.

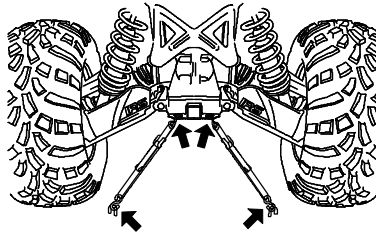
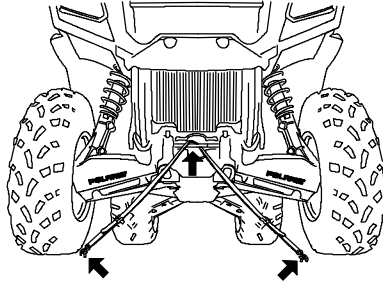

# ADJUSTMENTS

## Camber and Caster

The camber and caster are non-adjustable.

## Rear Spring

The rear shock absorber spring is adjusted by rotating the adjuster (1) either clockwise or counterclockwise to increase or decrease spring tension.

**NOTE:** Accessory springs are available through your Polaris dealer.

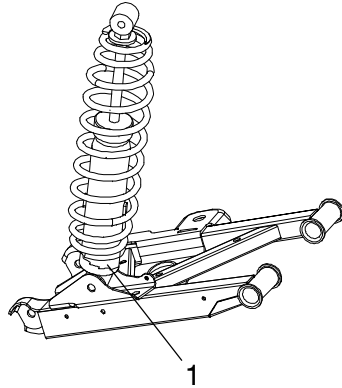

## Handlebars

The handlebars can be adjusted for rider preference.

### **WARNING**

Improper adjustment of the handlebars or incorrect torquing of the adjuster block tightening bolts can cause limited steering or loosening of the handlebars, resulting in loss of control and possible serious personal injury or death. Follow the adjustment procedures exactly, or see your Polaris dealer for service.

1. Locate handlebar bolts (1) by removing the upper headlight pod.
2. Loosen the four bolts.
3. Adjust the handlebar to the desired height. Be sure the handlebars do not contact the gas tank or any other part of the machine when turned fully to the left or right.
4. Torque the front two bolts to 10-12 ft. lbs. (14-17 Nm), then torque the rear two bolts. A gap of up to 1/8" will remain at the rear bolts.

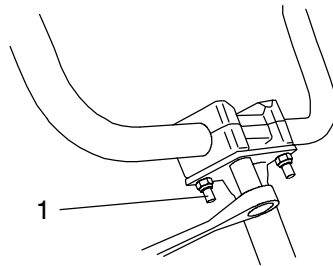

# ADJUSTMENTS

## Throttle Body/Idle RPM

Idle RPM is preset by the manufacturer. If the engine idle speed is not satisfactory, please see your Polaris dealer for adjustment.

## Throttle Cable Freeplay

Throttle cable freeplay is adjusted at the handlebar.

1. Locate the throttle cable adjuster on the handlebar.
2. Squeeze the end of the rubber boot (1) and slide it far enough to expose the end of the inline cable adjuster (2).
3. Loosen the locknut (3).
4. Rotate the boot to turn the adjuster until  $1/16''$  to  $1/8''$  freeplay is achieved at the thumb lever.

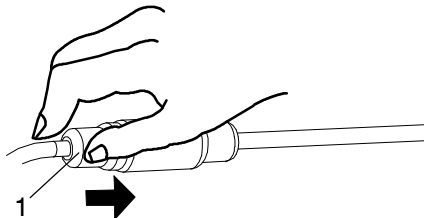

**NOTE:** While adjusting freeplay, be sure to flip the throttle lever back and forth.

5. Tighten the locknut.
6. Squeeze the end of the rubber boot and slide it over the cable adjuster to its original position.

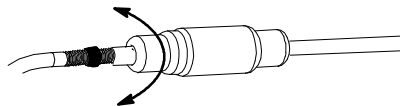
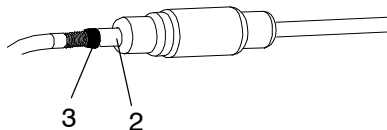

# POLARIS PRODUCTS

<b>Part No.</b>	<b>Description</b>
<b>Engine Lubricant</b>	
<b>2870791</b>	Fogging Oil (12 oz. Aerosol)
<b>2871281</b>	Premium 4 Synthetic 0W-40 (4-Cycle) Engine Oil (qt.)
<b>2871844</b>	Premium 4 Synthetic 0W-40 (4-Cycle) Engine Oil (gal.)
<b>Gearcase / Transmission Lubricants</b>	
<b>2873602</b>	Premium AGL Synthetic Gearcase Lube (qt.)
<b>2873603</b>	Premium AGL Synthetic Gearcase Lube (gal.)
<b>2871653</b>	Premium ATV Angle Drive Fluid (8 oz.)
<b>2872276</b>	Premium ATV Angle Drive Fluid (2.5 gal.)
<b>2870465</b>	Pump for Gallon Jug
<b>2871654</b>	Premium Demand Drive Hub Fluid (8 oz.)
<b>2872277</b>	Premium Demand Drive Hub Fluid (2.5 gal.)
<b>Grease / Specialized Lubricants</b>	
<b>2871322</b>	Premium All Season Grease (3 oz. cartridge)
<b>2871423</b>	Premium All Season Grease (14 oz. cartridge)
<b>2871460</b>	Starter Drive Grease
<b>2871515</b>	Premium U-Joint Lube (3 oz.)
<b>2871551</b>	Premium U-Joint Lube (14 oz.)
<b>2871312</b>	Grease Gun Kit
<b>2871329</b>	Dielectric Grease (Nyogel™)
<b>2872073</b>	Chain Lube (6.25 oz. aerosol)
<b>2872348</b>	Chain Lube (16 oz. aerosol)
<b>Coolant</b>	
<b>2871323</b>	60/40 Coolant (gal.)
<b>2871534</b>	60/40 Coolant (qt.)
<b>Additives / Miscellaneous</b>	
<b>2872889</b>	Brake and Clutch Cleaner
<b>2871326</b>	Carbon Clean Plus (12 oz.)
<b>2870652</b>	Fuel Stabilizer (16 oz.)
<b>2870990</b>	DOT3 Brake Fluid
<b>2872893</b>	Engine Degreaser
<b>2871956</b>	LOCTITE 565 Thread Sealant



# TROUBLESHOOTING

Contact your Polaris dealer for service if you're unable to identify solutions using the following charts.

Drive Belt and Cover Problems	
Possible Cause	Solution
Driving onto a pickup or tall trailer in high range	Shift transmission to low range during loading of the ATV to prevent belt burning.
Starting out going up a steep incline	When starting out on an incline, use low range or dismount the ATV (after first applying the park brake) and perform the K-turn as described on page 64.
Driving at low RPM or low ground speed (at approximately 3-7 MPH)	Drive at a higher speed or use low range more frequently. The use of low range is highly recommended for cooler PVT operating temperatures and longer component life.
Insufficient warm-up of ATVs exposed to low ambient temperatures	Warm the engine at least 5 minutes. With the transmission in neutral, advance the throttle to about 1/8 throttle in short bursts, 5 to 7 times. The belt will become more flexible and prevent belt burning.
Slow/easy clutch engagement	Use the throttle quickly and effectively.
Towing/pushing at low RPM/low ground speed	Use low range only.
Utility use/plowing	Use low range only.
Stuck in mud or snow	Shift the transmission to low range, and carefully use fast, aggressive throttle application to engage clutch. <b>WARNING:</b> Excessive throttle may cause loss of control and vehicle overturn.
Climbing over large objects from a stopped position	Shift the transmission to low range and carefully use fast, brief, aggressive throttle application to engage clutch. <b>WARNING:</b> Excessive throttle may cause loss of control and vehicle overturn.
Belt slippage from water or snow ingestion into the PVT system	Shift the transmission to neutral. Using the throttle, vary the engine RPM from idle to full throttle. Repeat several times as required. During this procedure, the throttle should not be held at the full position for more than 10 seconds. Clutch seals should be inspected for damage if repeated leaking occurs.
Clutch malfunction	See your Polaris dealer.
Poor engine performance	Check for fouled plug or foreign material in gas tank or fuel lines. See your dealer.
Slippage from failure to warm up belt	Always warm up the belt by operating below 30 mph for one mile (5 miles or more when temperature is below freezing).
Wrong or missing belt	Always use the recommended belt.
Improper break-in	Always break in a new belt and/or clutch by avoiding aggressive or high speed operation during the first two full tanks of fuel.

# TROUBLESHOOTING

## Engine Doesn't Turn Over

Possible Cause	Solution
Low battery voltage	Recharge battery to 12.5 VDC
Loose battery connections	Check all connections and tighten
Loose solenoid connections	Check all connections and tighten

## Engine Turns Over, Fails to Start

Possible Cause	Solution
Out of fuel	Refuel, cycle key to ON position three times for 5 seconds each, then start
Clogged fuel filter	Inspect and clean or replace
Water is present in fuel	Drain the fuel system and refuel
Old or non-recommended fuel	Replace with new fuel
Fouled or defective spark plug(s)	Inspect plug(s), replace if necessary
No spark to spark plug	Inspect plug(s), verify stop switch is on
Crankcase filled with water or fuel	Immediately see your Polaris dealer
Clogged fuel filter	Replace the filter
Low battery voltage	Recharge battery to 12.5 VDC
Mechanical failure	See your Polaris dealer

## Engine Backfires

Possible Cause	Solution
Weak spark from spark plug	Inspect, clean and/or replace spark plug
Incorrect spark plug gap or heat range	Set gap to specs or replace plug
Old or non-recommended fuel	Replace with new fuel
Incorrectly installed spark plug wires	See your Polaris dealer
Incorrect ignition timing	See your Polaris dealer
Mechanical failure	See your Polaris dealer
Loose ignition connections	Check all connections and tighten
Water present in fuel	Replace with new fuel

# TROUBLESHOOTING

## Engine Pings or Knocks

Possible Cause	Solution
Poor quality or low octane fuel	Replace with recommended fuel
Incorrect ignition timing	See your Polaris dealer
Incorrect spark plug gap or heat range	Set gap to specs or replace plug

## Engine Runs Irregularly, Stalls or Misfires

Possible Weak Spark Cause	Solution
Fouled or defective spark plug	Inspect, clean and/or replace spark plug
Worn or defective spark plug wires	See your Polaris dealer
Incorrect spark plug gap or heat range	Set gap to specs or replace plug
Loose ignition connections	Check all connections and tighten
Water present in fuel	Replace with new fuel
Low battery voltage	Recharge battery to 12.5 VDC
Kinked or plugged fuel vent line	Inspect and replace
Incorrect fuel	Replace with recommended fuel
Clogged air filter	Inspect and clean or replace
Reverse speed limiter malfunction	See your Polaris dealer
Electronic throttle control malfunction	See your Polaris dealer
Other mechanical failure	See your Polaris dealer

Possible Lean Fuel Mixture Cause	Solution
Low or contaminated fuel	Add or change fuel, clean the fuel system
Kinked or plugged fuel tank vent line	Inspect and replace
Low octane fuel	Replace with recommended fuel
Clogged fuel filter	Replace filter

Possible Rich Fuel Mixture Cause	Solution
Fuel is very high octane	Replace with lower octane fuel
Stopping/starting without adequate warm-up	Allow engine to warm up before operating and/or stopping
Incorrect fuel	Replace with recommended fuel
Clogged air filter	Inspect and clean or replace

# TROUBLESHOOTING

## Engine Stops or Loses Power

Possible Cause	Solution
Out of fuel	Refuel
Kinked or plugged fuel vent line	Inspect and replace
Water present in fuel	Replace with new fuel
Fouled or defective spark plug	Inspect, clean and/or replace spark plug
Worn or defective spark plug wires	See your Polaris dealer
Incorrect spark plug gap or heat range	Set gap to specs or replace plug
Loose ignition connections	Check all connections and tighten
Low battery voltage	Recharge battery to 12.5 VDC
Incorrect fuel	Replace with recommended fuel
Clogged air filter	Inspect and clean or replace
Reverse speed limiter malfunction	See your Polaris dealer
Electronic throttle control malfunction	See your Polaris dealer
Other mechanical failure	See your Polaris dealer
Overheated engine	Clean radiator screen and core Clean engine exterior See your Polaris dealer

## Engine Overheating

Possible Cause	Solution
Debris lodged in screen	Remove and clean the screen. Pull on the top portion of the screen, then remove the lower portion.
Plugged Radiator	Use a garden hose to flush any debris from the radiator fins. <b>NOTE:</b> High pressure washers can deform the radiator fins and reduce cooling efficiency.

# SPECIFICATIONS

<b>SPORTSMAN X2 500 EFI</b>	
Gross Vehicle Weight	1500 lbs./680 kg
Hitch Towing Rating	1225 lbs./556 kg
Unbraked Trailer Towing Capacity*	1995 lbs./905 kg
Hitch Tongue Capacity	120 lbs./54.4 kg (Rear box capacity and tongue weight not to exceed 400 lbs./181 kg)
Front Rack/Storage Box Capacity	90 lbs./40.8 kg
Rear Box Capacity	400 lbs./181 kg
Overall Length	93 in./236 cm
Overall Width	48 in./122 cm
Overall Height	48 in./122 cm
Wheelbase	57 in./145 cm
Ground Clearance	11 in./28 cm
Dry Weight	798 lbs./362 kg
Minimum Turning Radius	82 in./208 cm
Fuel Capacity	6 gal./22.7 l
Engine Oil Capacity	2 qts./1.9 l
Coolant Capacity	2.5 qts./2.4 l
Engine	EH50PLE210
Displacement	499
Bore x Stroke	92 x 75
Alternator Output	350 w
Compression Ratio	10.2:1 Full Stroke
Ignition System	Electronic Ignition
Ignition Timing	10 +/- 1 BTDC @ idle condition
Engine Idle RPM	1150 +/- 50 RPM
Spark Plug	NGK BKR6E
Spark Plug Gap	.035+0.0/-0.004 in. (0.9+0.0/-0.1 mm)
Lubrication System	Dry Sump
Driving System Type	Automatic PVT (Polaris Variable Transmission)

\* Based on EU Directive 76/432/EC

# SPECIFICATIONS

## SPORTSMAN X2 500 EFI

Shift Type	Side Lever (H/L/N/R/P)
Gear Reduction - Low	23.91/1
Gear Reduction - Reverse	21.74/1
Gear Reduction - Forward	10.57/1
Drive Ratio - Front	3.82/1
Tire, Front	Carlisle AT489 25 x 8 - 12 (5 psi)
Tire, Rear	Carlisle AT489 25 x 11 - 12 (5 psi)
Front Brake	Single-control hydraulic disc
Rear Brake	Single-control hydraulic disc
Auxiliary Brake	Hydraulic, opposed piston caliper, fixed disc
Parking Brake	Hydraulic lock, all wheel
Front Suspension	MacPherson Strut with 8.2" (20.8 cm) of travel
Rear Suspension	Progressive Rate with 8.75" (22.2 cm) of travel
Shock Adjustment	Rear Spring Preload Adjust
Headlight	1 - Single Beam on Headlight Pod (50 w) 2 - Single Beam on Bumper (27 w)
Taillights	8.26 w
Brakelight	26.9 w
Instrument Cluster	LCD

## Clutching Chart

Altitude		Shift Weight	Drive Clutch Spring	Driven Clutch Spring	Helix*
Meters (Feet)	0-1800 (0-6000)	10 WH PN 5630710	Blue/Green PN 7041157	White/Yellow PN 7041635	EBS PN 5131674
	1800-3700 (6000-12000)	10 RH PN 5630709	Blue/Green PN 7041157	White/Yellow PN 7041635	EBS PN 5131674

\*EBS models require no helix / spring adjustment

# **WARRANTY**

## **LIMITED WARRANTY**

Polaris Sales Inc., 2100 Highway 55, Medina, MN 55340, gives a SIX MONTH LIMITED WARRANTY on all components of the Polaris All Terrain Vehicle (ATV) against defects in material or workmanship. Polaris also gives a one year limited warranty on the final drive chain for failure due to defects. This warranty covers the parts and labor charges for repair or replacement of defective parts which are covered by this warranty. This warranty begins on the date of purchase. This warranty is transferrable to another consumer during the warranty period through a Polaris dealer.

## **REGISTRATION**

At the time of sale, the Warranty Registration Form must be completed by your dealer and submitted to Polaris within ten days. Upon receipt of this registration, Polaris will record the registration for warranty. No verification of registration will be sent to the purchaser as the copy of the Warranty Registration Form will be the warranty entitlement. If you have not signed the original registration and received the customer copy, please contact your dealer immediately. **NO WARRANTY COVERAGE WILL BE ALLOWED UNLESS YOUR ATV IS REGISTERED WITH POLARIS.**

Initial dealer preparation and set-up of your ATV is very important in ensuring trouble-free operation. Purchasing a machine in the crate or without proper dealer set-up will void your warranty coverage.

# WARRANTY

## WARRANTY COVERAGE AND EXCLUSIONS:

### LIMITATIONS OF WARRANTIES AND REMEDIES

The Polaris limited warranty excludes any failures that are not caused by a defect in material or workmanship. This warranty does not cover accidental damage, normal wear and tear, abuse or improper handling. This warranty also does not cover any ATV that has been altered structurally, modified, neglected, improperly maintained, used for racing, or used for purposes other than for which it was manufactured, or for any damages which occur during trailer transit or as a result of unauthorized service or the use of unauthorized parts. In addition, this warranty does not cover physical damage to paint or finish, stress cracks, tearing or puncturing of upholstery material, corrosion, or defects in parts, components or the ATV due to fire, explosions or any other cause beyond Polaris' control.

This warranty does not cover the use of unauthorized lubricants, chemicals, or fuels that are not compatible with the ATV. The exclusive remedy for breach of this warranty shall be, at Polaris' exclusive option, repair or replacement of any defective materials, or components or products. **THE REMEDIES SET FORTH IN THIS WARRANTY ARE THE ONLY REMEDIES AVAILABLE TO ANY PERSON FOR BREACH OF THIS WARRANTY. POLARIS SHALL HAVE NO LIABILITY TO ANY PERSON FOR INCIDENTAL, CONSEQUENTIAL OR SPECIAL DAMAGES OF ANY DESCRIPTION, WHETHER ARISING OUT OF EXPRESS OR IMPLIED WARRANTY OR ANY OTHER CONTRACT, NEGLIGENCE, OR OTHER TORT OR OTHERWISE.** Some states do not permit the exclusion or limitation of incidental or consequential damages or implied warranties, so the above limitations or exclusions may not apply to you if inconsistent with controlling state law.



# WARRANTY

ALL IMPLIED WARRANTIES (INCLUDING BUT NOT LIMITED TO THE IMPLIED WARRANTIES OF MERCHANTABILITY AND FITNESS FOR A PARTICULAR PURPOSE) ARE LIMITED IN DURATION TO THE ABOVE SIX MONTH WARRANTY PERIOD. POLARIS FURTHER DISCLAIMS ALL EXPRESS WARRANTIES NOT STATED IN THIS WARRANTY. Some states do not allow limitations on how long an implied warranty lasts, so the above limitation may not apply to you if inconsistent with controlling state law.

## HOW TO OBTAIN WARRANTY SERVICE

If your ATV requires warranty service, you must take it to a Polaris dealer authorized to repair Polaris ATVs. When requesting warranty service you must present your copy of the Warranty Registration form to the dealer. (THE COST OF TRANSPORTATION TO AND FROM THE DEALER IS YOUR RESPONSIBILITY). Polaris suggests that you use your original selling dealer; however, you may use any Polaris Servicing Dealer to perform warranty service.

Please work with your dealer to resolve any warranty issues. Should your dealer require any additional assistance they will contact the appropriate person at Polaris.

This warranty gives you specific legal rights, and you may also have other rights which vary from state to state.

If any of the above terms are void because of state or federal law, all other warranty terms will remain in effect.

## Engine Oil

1. Mixing oil brands or using non-recommended oil may cause engine damage. We recommend the use of Polaris engine oil for your ATV.
2. Damage resulting from the use of non-recommended lubricants may not be covered by warranty.

## SPARK ARRESTOR

Polaris warrants that the spark arrestor in this vehicle will meet the efficiency requirements of 43 CFR 8340.1(c) for 1000 hours when subjected to normal use and when maintenance and installation are in accordance with Polaris recommendations.

# WARRANTY

## Exported Vehicles

EXCEPT WHERE SPECIFICALLY REQUIRED BY LAW, THERE IS NO WARRANTY OR SERVICE BULLETIN COVERAGE ON THIS VEHICLE IF IT IS SOLD OUTSIDE THE COUNTRY OF THE SELLING DEALER'S AUTHORIZED LOCATION.

This policy does not apply to vehicles that have received authorization for export from Polaris Industries. Dealers may not give authorization for export. You should consult an authorized dealer to determine this vehicle's warranty or service bulletin coverage if you have any questions.

This policy does not apply to vehicles registered to government officials or military personnel on assignment outside the country of the selling dealer's authorized location.

This policy does not apply to Safety Recalls.

## How to Get Service

### *In the Country where your vehicle was purchased:*

Warranty or Service Bulletin repairs must be done by an authorized Polaris dealer. If you move or are traveling within the country where your vehicle was purchased, Warranty or Service Bulletin repairs may be requested from any authorized Polaris dealer who sells the same line as your vehicle.

### *Outside the Country where your vehicle was purchased:*

If you are traveling temporarily outside the country where your vehicle was purchased, you should take your vehicle to an authorized Polaris dealer. You must show the dealer photo identification from the country of the selling dealer's authorized location as proof of residence. Upon residence verification, the servicing dealer will be authorized to perform the warranty repair.

### *If You Move:*

If you move to another country, be sure to contact Polaris Customer Assistance and the customs department of the destination country before you move. Vehicles importation rules vary considerably from country to country. You may be required to present documentation of your move to Polaris Industries in order to continue your warranty coverage. You may also be required to obtain documentation from Polaris Industries in order to register your vehicle in your new country.

# **WARRANTY**

## **Exported Vehicles**

### **How to Get Service**

#### ***If Purchased From A Private Party:***

If you purchase a Polaris product from a private citizen outside of the country in which the vehicle was originally purchased, all warranty coverage will be denied.

#### **Notice**

If your vehicle is registered outside of the country where it was purchased, and you have not followed the procedure set out above, your vehicle will no longer be eligible for warranty or service bulletin coverage of any kind. (Vehicles registered to Government officials or military personnel on assignment outside of the country where the vehicle was purchased will continue to be covered by the basic warranty.)

#### ***For questions call Polaris Customer Assistance:***

United States: 1-763-417-8650

Canada: 1-204-925-7100

# WARRANTY

## U.S.A. EPA Emissions Limited Warranty

This All Terrain Vehicle (ATV) or Off Road Utility Vehicle (ORUV) emissions limited warranty is in addition to the Polaris standard limited warranty for this vehicle.

Polaris warrants that this vehicle is; (1) designed, built, and equipped to conform at the time of initial sale with the requirements of 40 CFR 1051 and, (2) free from defects in materials and workmanship that may keep it from meeting these requirements.

The emissions warranty period for this vehicle begins on the date the vehicle is delivered to the original retail purchaser and ends 30 months (2.5 years) after that date, or after 5000 km (3100 miles), whichever comes first.

This emission-related warranty covers components whose failure would increase an engine's emissions, including electronic controls, fuel injection, exhaust-gas recirculation, aftertreatment, or any other system utilized in this vehicle to control emissions. Replacing or repairing other components not covered by this emissions warranty or the standard warranty is the responsibility of the owner; including the parts, labor and other costs associated with recommended maintenance.

The exclusive remedy for breach of this limited warranty shall be, at the exclusive option of Polaris, repair or replacement of any defective materials, components or products. **THE REMEDIES SET FORTH IN THIS LIMITED WARRANTY ARE THE ONLY REMEDIES AVAILABLE TO ANY PERSON FOR BREACH OF THIS WARRANTY. POLARIS SHALL HAVE NO LIABILITY TO ANY PERSON FOR INCIDENTAL, CONSEQUENTIAL OR SPECIAL DAMAGES OF ANY DESCRIPTION, WHETHER ARISING OUT OF EXPRESS OR IMPLIED WARRANTY OR ANY OTHER CONTRACT, NEGLIGENCE OR OTHER TORT OR OTHERWISE.**

**ALL IMPLIED WARRANTIES (INCLUDING BUT NOT LIMITED TO ANY IMPLIED WARRANTIES OF MERCHANTABILITY AND FITNESS FOR A PARTICULAR PURPOSE) ARE LIMITED IN DURATION TO THE WARRANTY PERIOD DESCRIBED HEREIN. POLARIS DISCLAIMS ALL EXPRESS WARRANTIES NOT STATED IN THIS WARRANTY.** Some states do not allow limitations on how long an implied warranty lasts, so the above limitation may not apply if it is inconsistent with the controlling state law.

This limited warranty excludes failures not caused by a defect in material or workmanship. This limited warranty does not cover damage due to accidents, abuse or improper handling, maintenance or use. This limited warranty also does not cover any engine that has been structurally altered, or any engine that has been used in racing competition. This limited warranty also does not cover physical damage, corrosion or defects caused by fire, explosions or other similar causes beyond the control of Polaris.

If you have any questions regarding your warranty rights and responsibilities, you should contact the Polaris Warranty Department at 1-763-417-8650.

# MAINTENANCE LOG

Use the following chart to record periodic maintenance.

DATE	MILES (KM)	TECHNICIAN	SERVICE PERFORMED / COMMENTS

# MAINTENANCE LOG

DATE	MILES (KM)	TECHNICIAN	SERVICE PERFORMED / COMMENTS

# INDEX

## A

Accessories .....	110
Adjustments .....	115-116
Age Restrictions .....	12
Air Filter Service .....	96
All Wheel Drive .....	43-44
Automatic Transmission .....	42
Auxiliary Brake .....	91
AWD .....	43-44

## B

Battery .....	107-109
Battery (Conventional) .....	106
Battery Charging (Sealed) ....	108-109
Battery Fluid (Conventional) ....	108
Battery Installation .....	107
Battery Removal .....	107
Battery Storage .....	108
Belt Break-in .....	53
Belt Life .....	42
Brake Fluid .....	39, 41
Brake Lever .....	38
Brake, Auxiliary .....	41
Brakelight .....	100
Brakes .....	90-91
Break-In Period .....	53
Breather Filter .....	96

## C

Camber and Caster .....	115
Cleaning .....	110-113
Clutch Break-in .....	53
Clutching Chart .....	123
Cold Weather Operation .....	55
Coolant Level .....	89
Cooling System .....	89
Cooling System Operation .....	89
Crankcase Emission Control System	73

## D

Diagnostic Mode .....	51
Diagnostic Mode, Instrumentation	49-50
Drivetrain Break-In .....	53
Driving Downhill .....	63
Driving in Reverse .....	68
Driving on a Hillside .....	62
Driving on Slippery Surfaces .....	60
Driving Over Obstacles .....	69
Driving Procedures .....	56
Driving Through Water .....	66-67

## D

Driving Uphill .....	61
Driving With a Passenger .....	58-59
Dumping Cargo .....	72

## E

Electrical Switches .....	36
Emission Control Systems .....	73
Emissions Warranty .....	129
Engaging Front Gearcase .....	44
Engine Break-In .....	53
Engine Cooling System .....	88
Engine Stop Switch .....	36
Equipment Modifications .....	18
Exhaust Emission Control System .	73

## F

Filter Systems .....	96
Footwell Removal .....	93
Front Gearcase Oil .....	87
Front Wheel Hub Tightening .....	94
Fuel Filter .....	42
Fuel Safety .....	52
Fuel Tank .....	42

## G

Gear Selector .....	42
---------------------	----

## H

Handlebars .....	115
Hauling Cargo .....	70-72
Headlamp (Lower) .....	100
Headlight Housing Replacement ...	99
Headlight Lamp Replacement .....	97
High Beam Adjustment .....	98
High Range .....	104
Hour Meter .....	48

## I

Idle RPM .....	116
Instrument Cluster .....	46-51

## K

K-Turn .....	64
--------------	----

## L

Light Switches .....	38
Lights .....	97-100
Load Distribution .....	71
Low Beam Adjustment .....	98
Low Range .....	104
Lubrication Guide .....	79

# INDEX

## M

Main Switch	36
Maintenance	74-114
Maintenance Chart	74-78
Maintenance Log	130-131
Making Turns	57
Master Cylinder	39
Mode/Reverse Override Switch	36

## N

Noise Emission Control System	73
-------------------------------	----

## O

Odometer	48
Oil Change	82-84
Oil Filter Change	82
Oil Level	81
Oil Pump Priming	84

## P

Parking Brake	40
Parking on an Incline	69
Passenger	58-59
Passenger Seat	44-45
Periodic Maintenance Chart	74-78
Polaris Products	117
Pre-Ride Inspection	54
Premium 4 Synthetic Lubricant	80
PVT Break-In	53
PVT Drying	105
PVT System	104-105

## R

Radiator Coolant Level	88
Rear Spring	115
Reverse Override Switch	36
Rider Information Center	47-51
Rider Safety	14-35

## S

Safe Riding Gear	13
Safety Decals and Locations	6-11
Safety Training	12
Seat Conversion	44
Setting the Parking Brake	40
Severe Use	74
Side Panel Removal	93
Sidehilling	62
Spark Arrestor	103
Spark Plugs	101
Specifications	122-123
Starting the Engine	55
Steering Assembly	92
Stop Switch	36
Storage	110-113
Storage Tips	111-113
Switches	36

## T

Tachometer	48
Taillight	100
Throttle Body	116
Throttle Cable Freeplay	116
Throttle Lever	37
Tires 94	
Toe Alignment	92
Towing Capacities	71
Transmission Oil	85-86
Transporting the ATV	114
Trip Meter	48
Troubleshooting	118-121
Turning Around on a Hill	64-65

## V

Vehicle Identification Numbers	5
Vehicle Immersion	102

## W

Warranty	124-129
Wheel Installation	95
Wheel Nut Torque Specifications	95
Wheel Removal	94
Worklight	100
Worklight Switch	36



## Free Manuals Download Website

<http://myh66.com>

<http://usermanuals.us>

<http://www.somanuals.com>

<http://www.4manuals.cc>

<http://www.manual-lib.com>

<http://www.404manual.com>

<http://www.luxmanual.com>

<http://aubethermostatmanual.com>

Golf course search by state

<http://golfingnear.com>

Email search by domain

<http://emailbydomain.com>

Auto manuals search

<http://auto.somanuals.com>

TV manuals search

<http://tv.somanuals.com>