

# 2009



**POLARIS**<sup>®</sup>  
The Way Out.

## **Sportsman X2 500 EFI Sportsman X2 800 EFI**

### **Owner's Manual for Maintenance and Safety**

**Read this manual carefully. It contains important safety information.**

**This is an adult vehicle only.**

**Operation is prohibited for those under 16 years of age.**

# **WARNING**

Improper vehicle use can result in **SEVERE INJURY** or **DEATH**.



**ALWAYS USE  
AN APPROVED  
HELMET AND  
PROTECTIVE GEAR  
FOR DRIVER  
AND PASSENGER**



**NEVER USE  
ON PUBLIC  
ROADS**



**NEVER CARRY  
MORE THAN  
1 PASSENGER**



**NEVER USE  
WITH DRUGS  
OR ALCOHOL**

**NEVER operate:**

- without proper ATV training or instruction
- at speeds too fast for your skills or the conditions
- on public roads - a collision can occur with another vehicle
- with a passenger unless passenger seat is securely in place

**THE OPERATOR MUST ALWAYS:**

- use proper riding techniques to avoid overturns on hills and rough terrain and in turns
- avoid paved surfaces - pavement may seriously affect handling and control
- reduce speed and use extra caution at all times when carrying a passenger - dismount passenger when conditions require
- make sure passenger reads and understands this label and passenger safety label

**LOCATE AND READ OWNER'S MANUAL.  
FOLLOW ALL INSTRUCTIONS AND WARNINGS.**



**POLARIS**  
The Way Out.

For your nearest Polaris dealer,  
call 1-800-POLARIS  
or visit [www.polarisindustries.com](http://www.polarisindustries.com)  
Polaris Sales Inc., 2100 Hwy 55  
Medina, MN 55340  
Phone 1-888-704-5290  
Part No. 9921845 Rev 02  
Printed in USA

**⚠ WARNING**

The engine exhaust from this product contains chemicals known to the State of California to cause cancer, birth defects or other reproductive harm.

A card containing important ATV safety information should be attached to the owner's manual on the next page. If you cannot locate this card, or if it has been removed, please call 1-800-342-3764 for assistance.

# WELCOME

Thank you for purchasing a Polaris vehicle, and welcome to our world-wide family of Polaris owners. We proudly produce an exciting line of utility and recreational products.

- Snowmobiles
- All-terrain vehicles (ATVs)
- *RANGER* utility vehicles
- Victory motorcycles

We believe Polaris sets a standard of excellence for all utility and recreational vehicles manufactured in the world today. Many years of experience have gone into the engineering, design, and development of your Polaris vehicle, making it the finest machine we've ever produced.

For safe and enjoyable operation of your vehicle, be sure to follow the instructions and recommendations in this owner's manual. Your manual contains instructions for minor maintenance, but information about major repairs is outlined in the Polaris Service Manual and should be performed only by a Factory Certified Master Service Dealer (MSD) Technician.

Your Polaris dealer knows your vehicle best and is interested in your total satisfaction. Be sure to return to your dealership for all of your service needs during, and after, the warranty period.

We also take great pride in our complete line of apparel, parts and accessories, available through our online store at [www.purepolaris.com](http://www.purepolaris.com). Have your accessories and clothing delivered right to your door!



POLARIS and POLARIS THE WAY OUT are registered trademarks of Polaris Industries Inc.

Copyright 2008 Polaris Sales Inc. All information contained within this publication is based on the latest product information at the time of publication. Due to constant improvements in the design and quality of production components, some minor discrepancies may result between the actual vehicle and the information presented in this publication. Depictions and/or procedures in this publication are intended for reference use only. No liability can be accepted for omissions or inaccuracies. Any reprinting or reuse of the depictions and/or procedures contained within, whether whole or in part, is expressly prohibited.

Printed in U.S.A.

2009 Sportsman 500/800 X2 Owner's Manual

P/N 9921845

# TABLE OF CONTENTS

<b>Introduction</b> .....	<b>4</b>
<b>Safety</b> .....	<b>7</b>
<b>Features and Controls</b> .....	<b>28</b>
<b>Operation</b> .....	<b>50</b>
<b>Emission Control Systems</b> .....	<b>74</b>
<b>Maintenance</b> .....	<b>75</b>
<b>Adjustments</b> .....	<b>126</b>
<b>Troubleshooting</b> .....	<b>129</b>
<b>Polaris Products</b> .....	<b>133</b>
<b>Specifications</b> .....	<b>134</b>
<b>Warranty</b> .....	<b>138</b>
<b>Maintenance Log</b> .....	<b>144</b>
<b>Index</b> .....	<b>146</b>

# INTRODUCTION

The following signal words and symbols appear throughout this manual and on your vehicle. Your safety is involved when these words and symbols are used. Become familiar with their meanings before reading the manual.



The safety alert symbol indicates a potential personal injury hazard.

## **WARNING**

A **WARNING** indicates a hazardous situation which, if not avoided, may result in death or serious injury.

## **CAUTION**

A **CAUTION** indicates a hazardous situation which, if not avoided, may result in minor or moderate injury.

## **NOTICE**

A **NOTICE** indicates a situation that may result in property damage.



The Prohibition Safety Sign indicates an action **NOT** to take in order to avoid a hazard.



The Mandatory Action Sign indicates an action that **NEEDS** to be taken to avoid a hazard.

# INTRODUCTION

## **WARNING**

Failure to heed the warnings and safety precautions contained in this manual can result in severe injury or death. A Polaris ATV is not a toy and can be hazardous to operate. This vehicle handles differently than other vehicles, such as motorcycles and cars. A collision or rollover can occur quickly, even during routine maneuvers like turning, or driving on hills or over obstacles, if you fail to take proper precautions.

- Read this owner's manual. Understand all safety warnings, precautions and operating procedures before operating a Polaris ATV. Keep this manual with the ATV.
- Never operate an ATV without proper instruction. Take a training course. Purchasers of a new Polaris ATV and their eligible family members are entitled to take the *ATV RiderCourse*<sup>sm</sup>. Contact ATV Enrollment Express at (800) 887-2887 or visit [www.atvsafety.org](http://www.atvsafety.org) for information on enrollment in the *ATV RiderCourse*<sup>sm</sup>.
- This vehicle is an **ADULT VEHICLE ONLY**. Operation is prohibited for anyone under 16 years of age.
- Never permit a guest to operate the ATV unless the guest has read this manual and all product labels and has completed a certified safety training course.



# INTRODUCTION

## Vehicle Identification Numbers

Record your vehicle's identification numbers and key number in the spaces provided. Remove the spare key and store it in a safe place. An ignition key can be duplicated only by ordering a Polaris key blank (using your key number) and mating it with one of your existing keys. The ignition switch must be replaced if all keys are lost.

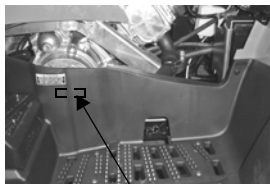
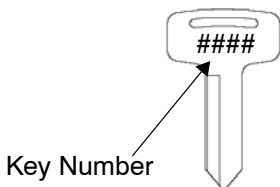
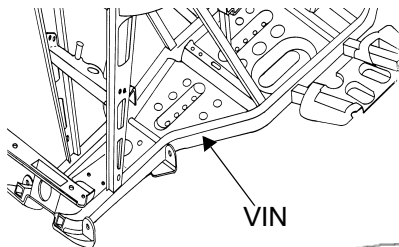

Engine Serial Number 500



800

Vehicle Model Number: \_\_\_\_\_

Frame VIN: \_\_\_\_\_

Engine Serial Number: \_\_\_\_\_

Key Number: \_\_\_\_\_

## Safety Training

ATV safety training is a top priority for Polaris. When you purchased your new ATV, your dealer instructed you on the authorized ATV *RiderCourse*<sup>sm</sup> available to you and your eligible family members. This training is included in the purchase price of your ATV. Polaris strongly encourages you and your eligible family members who will be riding the ATV to take the ATV *RiderCourse*<sup>sm</sup>. You were also provided with printed materials that explain safe operating procedures. You should review this information on a regular basis.

If you purchased a used Polaris ATV, you can take the ATV *RiderCourse*<sup>sm</sup> by calling ATV Enrollment Express at (800) 887-2887 or by visiting [www.atvsafety.org](http://www.atvsafety.org). Purchasers of a used Polaris ATV will be charged for this training.

A Polaris ATV is an off-road vehicle. Familiarize yourself with all laws and regulations concerning the operation of this vehicle in your area.

We strongly advise you to strictly follow the recommended maintenance program outlined in your owner's manual. This preventive maintenance program is designed to ensure that all critical components on your vehicle are thoroughly inspected at specific intervals.

**FOR MORE INFORMATION ABOUT ATV SAFETY, call the Consumer Product Safety Commission at 1-800-638-2772, or visit [www.cpsc.gov](http://www.cpsc.gov), visit [www.atvsafety.org](http://www.atvsafety.org), or call Polaris at 1-800-342-3764.**

# SAFETY

## Safe Riding Gear

Always wear appropriate clothing when riding an ATV. Wear protective clothing for comfort and to reduce the chance of injury.

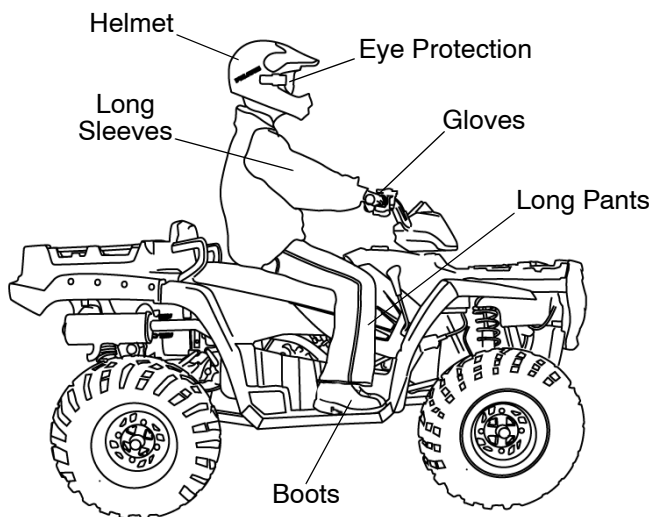

### Helmet

Wearing a helmet can prevent a severe head injury. Whenever riding a Polaris vehicle, always wear a helmet that meets or exceeds established safety standards. A passenger (on approved models) should wear a helmet that includes a rigid chin guard.

Approved helmets in the USA and Canada bear a U.S. Department of Transportation (DOT) label.

Approved helmets in Europe, Asia and Oceania bear the ECE 22.05 label. The ECE mark consists of a circle surrounding the letter E, followed by the distinguishing number of the country which has granted approval. The approval number and serial number will also be displayed on the label.

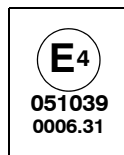

## Safe Riding Gear

### Eye Protection

Do not depend on eyeglasses or sunglasses for eye protection. Whenever riding a Polaris vehicle, always wear shatterproof goggles or use a shatterproof helmet face shield. Polaris recommends wearing approved Personal Protective Equipment (PPE) bearing markings such as VESC 8, V-8, Z87.1, or CE. Make sure protective eye wear is kept clean.

### Gloves

Off-road style gloves with knuckle pads are the best for comfort and protection.

### Boots

The best footwear is a pair of sturdy over-the-calf boots with low heels.

### Clothing

Always wear long sleeves and long pants to protect arms and legs. Riding pants with kneepads and a jersey with shoulder pads provide the best protection.

## Equipment Modifications

We strongly recommend that consumers do not install on a Polaris ATV any equipment that may increase the speed or power of the vehicle, or make any other modifications to the vehicle for these purposes.

The warranty on your Polaris ATV is terminated if any equipment has been added to the vehicle, or if any modifications have been made to the vehicle, that increase its speed or power.

The addition of certain accessories, including (but not limited to) mowers, blades, tires, sprayers, or large racks, may change the handling characteristics of the vehicle. Use only Polaris-approved accessories, and familiarize yourself with their function and effect on the vehicle.

# SAFETY

## Safety Warnings

### **⚠ WARNING**

Failure to operate the ATV properly can result in a collision, loss of control, accident or overturn, which may result in serious injury or death. Heed all safety warnings outlined in this section of the owner's manual. See the OPERATION section of the owner's manual for proper operating procedures.

### **Operating Without Instruction**

Operating this ATV without proper instruction increases the risk of an accident. The operator must understand how to operate the ATV properly in different situations and on different types of terrain.

Beginning and inexperienced operators should complete the recommended safety training before operating this vehicle. See page 7.

Never permit a guest to operate the ATV unless the guest has read this manual and all product labels and has completed a certified safety training course.

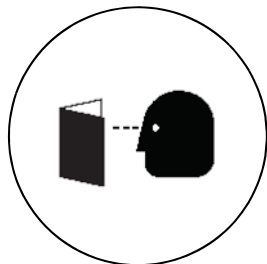

### **Age Restrictions**

This vehicle is an ADULT VEHICLE ONLY. Operation is prohibited for anyone under 16 years of age. Never allow anyone under 12 years of age to ride as a passenger on this 2-up ATV.

Even though a child may be within the recommended age group for operating some ATVs, he/she may not have the skills, abilities, or judgment needed to operate or ride on this ATV safely and could be susceptible to accident or injury.

## Safety Warnings

### Handling Gasoline

Gasoline is highly flammable and explosive under certain conditions.

- Always exercise extreme caution whenever handling gasoline.
- Always refuel with the engine stopped, and outdoors or in a well ventilated area.
- Do not smoke or allow open flames or sparks in or near the area where refueling is performed or where gasoline is stored.
- Do not overfill the tank. Do not fill the tank neck.
- If gasoline spills on your skin or clothing, immediately wash it off with soap and water and change clothing.

### Exposure to Exhaust

Engine exhaust fumes are poisonous and can cause loss of consciousness or death in a short time. Never start the engine or let it run in an enclosed area.

The engine exhaust from this product contains chemicals known to cause cancer, birth defects or other reproductive harm. Operate this vehicle only outdoors or in well-ventilated areas.

### Failure to Inspect Before Operating

Failure to inspect and verify that the ATV is in safe operating condition before operating increases the risk of an accident.

Always inspect the ATV before each use to make sure it's in safe operating condition.

Always follow all inspection and maintenance procedures and schedules described in the owner's manual.

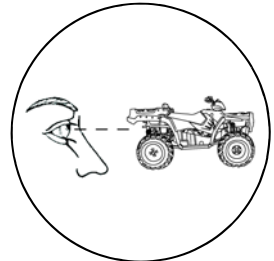

# SAFETY

## Safety Warnings

### Protective Apparel

Riding in this vehicle without wearing an approved helmet and protective eyewear increases the risk of a serious injuries in the event of an accident.

Operator and passenger must always wear an approved helmet that fits properly and eye protection (goggles or face shield).



### Carrying a Passenger

Do not carry a passenger until you have at least two hours of driving experience with this vehicle.

### Carrying More Than One Passenger

Carrying more than one passenger greatly reduces the operator's ability to balance and control the ATV, which may result in an accident or overturn.

Never carry more than one passenger on this 2-up ATV.



### Using Alcohol or Drugs

Operating the ATV after consuming alcohol or drugs could adversely affect operator judgment, reaction time, balance and perception.

Never consume alcohol or drugs before or while operating an ATV.



## Safety Warnings

### Carrying a Passenger in the Cargo Box

A passenger riding in the cargo box could fall from the vehicle unexpectedly or may contact moving components, both of which can result in severe injury or death. Never allow a passenger to ride in the cargo box.



### Operating on Pavement

Operating an ATV on paved surfaces (including sidewalks, paths, parking lots and driveways) may adversely affect the handling of the ATV and could result in loss of control and accident or overturn.

Avoid operating the ATV on pavement. ATV tires are designed for off-road use. If it's unavoidable, travel slowly and avoid sudden turns or stops.



### Operating on Public Roads

Operating this ATV on public streets, roads or highways could result in a collision with another vehicle.

Never operate the ATV on any public street, road or highway, including dirt and gravel roads. In many states it's unlawful to operate ATVs on public streets, roads and highways.



### Operating at Excessive Speeds

Operating the ATV at excessive speeds increases the operator's risk of losing control.

Never operate at excessive speeds. Travel at speeds appropriate for your skills, your passenger's skills, and operating conditions.

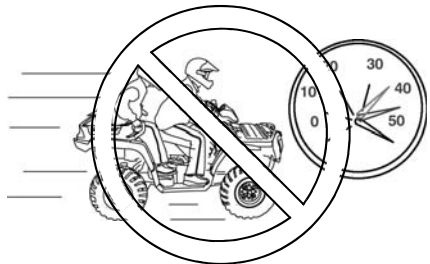



# SAFETY

## Safety Warnings

### Physical Control of the ATV

Removing even one hand or foot can reduce ability to control the vehicle or could cause loss of balance and ejection from the ATV.

If a person's feet are not firmly planted on the footrests, they could come into contact with the wheels or other moving parts and lead to accident or injury.

Always keep both hands on the handlebars and both feet on the footrests of the ATV during operation. A passenger should always be seated in the passenger seat with both feet on the footrests and both hands on the passenger grab handles at all times. The passenger should never hold on to the operator.



### Turning Improperly

Turning improperly could cause loss of traction, loss of control, accident or overturn.

Always follow proper procedures for turning as described in the owner's manual.

Practice turning at slow speeds before attempting to turn at faster speeds.

Never turn at excessive speed.



### Jumps and Stunts

Attempting wheelies, jumps and other stunts increases the risk of an accident or overturn.

Never attempt wheelies, jumps, or other stunts. Avoid exhibition driving.



## Safety Warnings

### Improper Hill Climbing

Improper hill climbing could cause loss of control or overturn. Always follow proper procedures for climbing hills as described in the owner's manual. See page 61.

Never operate with the differential unlocked (🔗) while operating on a hill or other irregular terrain. Always move the 4X4 switch to ADC 4X4 before ascending or descending a hill. See pages 29 and 39.



### Descending Hills Improperly

Improperly descending a hill could cause loss of control or overturn.

Always follow proper procedures for traveling down hills as described in the owner's manual. See page 63.

Never operate with the differential unlocked (🔗) while operating on a hill or other irregular terrain. Always move the 4X4 switch to ADC 4X4 before ascending or descending a hill. See pages 29 and 39.



### Crossing Hillside

Driving on a sidehill is not recommended. Improper procedure could cause loss of control or overturn. Avoid crossing the side of any hill unless absolutely necessary.

If crossing a hillside is unavoidable, always follow proper procedures as described in the owner's manual. See page 62.

Never attempt to turn the ATV around on any hill until you've mastered the turning technique (on level ground) as described in the owner's manual. See page 64.



# SAFETY

## Safety Warnings

### Stalling While Climbing a Hill

Stalling, rolling backwards or improperly dismounting while climbing a hill could cause an overturn.

- Always maintain a steady speed when climbing a hill.
- Always move the 4X4 switch to ADC 4X4 before ascending or descending a hill. See page 39.

*If all forward speed is lost:*

- Lean forward to keep body weight uphill. A passenger should also lean uphill.
- Apply the single lever brakes.
- Lock the parking brake when fully stopped.
- Dismount on the uphill side of the vehicle, or on the left if the vehicle is pointing straight uphill. Have a passenger dismount first, then the operator may dismount.
- Turn the ATV around and remount, following the procedure described in the owner's manual. See page 64.

*If the ATV begins rolling backwards:*

- Keep operator and passenger body weight uphill.
- Never apply engine power.
- Never apply the rear brake while rolling backwards.
- Apply the single-lever brake gradually.
- When fully stopped, apply the foot brake as well, and then lock the parking brake.
- Dismount on the uphill side of the vehicle, or on the left if the vehicle is pointing straight uphill. Have a passenger dismount first, then the operator may dismount.
- Turn the ATV around and remount, following the procedure described in the owner's manual. See page 64.

### Operating on Steep Hills

Operating on excessively steep hills could cause an overturn.

Never operate on hills too steep for the ATV or for your abilities. Never operate the ATV on hills steeper than 15 degrees.



## Safety Warnings

### Operating on Slippery Terrain

Failure to use extra caution when operating on excessively rough, slippery or loose terrain could cause loss of traction, loss of control, accident or overturn.

Do not operate on excessively rough, slippery or loose terrain until you've learned and practiced the skills necessary to control the ATV on such terrain.

Always use extra caution on rough, slippery or loose terrain.



### Operating in Unfamiliar Terrain

Failure to use extra caution when operating on unfamiliar terrain could result in an accident or overturn.

Unfamiliar terrain may contain hidden rocks, bumps, or holes that could cause loss of control or overturn.

Travel slowly and use extra caution when operating on unfamiliar terrain. Always be alert to changing terrain conditions.



### Operating Improperly in Reverse

Improperly operating in reverse could result in a collision with an obstacle or person. Always follow proper operating procedures as outlined in this manual. See page 68.

Before shifting into reverse gear, always check for obstacles or people behind the ATV. When it's safe to proceed, back slowly.



# SAFETY

## Safety Warnings

### Improper Tire Maintenance

Operating this ATV with improper tires or with improper or uneven tire pressure could cause loss of control or accident.

Always use the size and type of tires specified for your ATV.

Always maintain proper tire pressure as described in the owner's manual and on safety labels.



### Operating Over Obstacles

Improperly operating over obstacles could cause loss of control or overturn.

Before operating in a new area, check for obstacles. Avoid operating over large obstacles such as rocks and fallen trees. If unavoidable, use extreme caution and always follow proper operating procedures as outlined in this manual. See page 67.



### Skidding or Sliding

Skidding or sliding can cause loss of control or overturn (if tires regain traction unexpectedly).

On slippery surfaces such as ice or loose gravel, travel slowly and use extra caution to reduce the chance of skidding or sliding. Do not operate on excessively slippery surfaces.



## Safety Warnings

### Operating Through Deep Water

Operating the ATV through deep or fast-flowing water could cause the tires to float, causing loss of control or overturn.

Avoid operating the ATV through deep or fast-flowing water. If it's unavoidable to enter water that exceeds the recommended maximum depth (see page 66):

- Travel slowly.
- Balance your weight carefully.
- Avoid sudden movements.
- Maintain a slow and steady forward motion. Do not make sudden turns or stops, and do not make sudden throttle changes.

Wet brakes may have reduced stopping ability. After leaving water, test the brakes. Apply them lightly several times while driving. The friction will help dry out the pads.



### Improper Cargo Loading

Overloading the ATV or carrying/towing cargo improperly may cause changes in handling, which could cause loss of control or an accident.

- Never exceed the stated load capacity for this ATV.
- Cargo should be properly distributed and securely attached.
- Reduce speed when carrying cargo or pulling a trailer. Allow a greater distance for braking.
- Always follow the instructions in the owner's manual for carrying cargo or pulling a trailer.
- Always follow the instructions in the owner's manual for operating with a passenger. See page 58.



# SAFETY

## Safety Warnings

### Operating on Frozen Bodies of Water

Operating on frozen bodies of water may result in serious injury or death if the ATV and/or riders fall through the ice.

Never operate the ATV on a frozen body of water.

### Poor Visibility

Operating the ATV in darkness or inclement weather could result in a collision or accident, especially if operating on a road or street. This ATV is not equipped with highway-approved lights. Operate this vehicle off-road only. Use caution and drive at reduced speeds in conditions of reduced visibility such as fog, rain and darkness. Clean headlights frequently and replace burned out headlamps promptly.



## Safety Warnings

### Operating a Damaged ATV

Operating a damaged ATV can result in an accident. After any overturn or accident, have a qualified service dealer inspect the entire machine for possible damage, including (but not limited to) brakes, throttle and steering systems.

### Physical Skills

Safe operation of this rider-active vehicle requires good judgement and physical skills. Persons with cognitive or physical disabilities who operate this vehicle have an increased risk of overturn and loss of control. Never secure a passenger to the vehicle or to the operator with a belt, rope or similar device.

### Hot Exhaust Systems

Exhaust system components are very hot during and after use of the vehicle. Hot components can cause burns and fire. Do not touch hot exhaust system components. Always keep combustible materials away from the exhaust system. Use caution when traveling through tall grass, especially dry grass.

### Unauthorized Use of the ATV

Leaving the keys in the ignition can lead to unauthorized use of the vehicle, which could result in an accident or overturn. Always remove the ignition key when the vehicle is not in use.



# SAFETY

## Safety Labels and Locations

Warning labels have been placed on the vehicle for your protection. Read and follow the instructions on each label carefully. If any of the labels shown in this manual differ from the labels on your vehicle, always read and follow the instructions of the labels on the vehicle.

If an informational or graphic label becomes illegible or comes off, contact your Polaris dealer to purchase a replacement. Replacement *safety* labels are provided by Polaris at no charge. The part number is printed on the label.

### Age 16 Warning

#### WARNING

Operating this ATV if you are under the age of 16 increases the chances of severe injury or death to both operator and passenger.

**NEVER** operate this vehicle if you are under age 16.

7175375

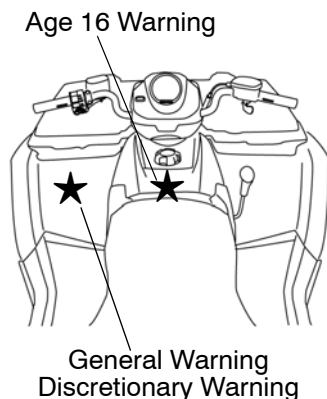

## Safety Labels and Locations

### General Warning/Discretionary Warning

#### WARNING

Improper ATV use can result in SEVERE INJURY or DEATH

ALWAYS USE AN APPROVED HELMET AND PROTECTIVE GEAR FOR DRIVER AND PASSENGER

NEVER USE ON PUBLIC ROADS

NEVER CARRY MORE THAN 1 PASSENGER

NEVER USE WITH DRUGS OR ALCOHOL

**NEVER** operate:

- without proper ATV training or instruction
- at speeds too fast for your skills or the conditions
- on public roads - a collision can occur with another vehicle
- with a passenger unless passenger seat is securely in place

THE OPERATOR MUST **ALWAYS**:

- use proper riding techniques to avoid overturns on hills and rough terrain and in turns
- avoid paved surfaces - pavement may seriously affect handling and control
- reduce speed and use extra caution at all times when carrying a passenger - dismount passenger when conditions require
- make sure passenger reads and understands this label and passenger safety label

LOCATE AND READ OPERATOR'S MANUAL.

FOLLOW ALL INSTRUCTIONS AND WARNINGS.

#### WARNING

- Never operate this ATV on HILLS steeper than 15 degrees  $\leq 15^\circ$ . To prevent overturn on hilly terrain, use throttle and brakes gradually.
- REVERSE operation can be dangerous even at low speeds. Steering becomes difficult. To prevent loss of control, avoid sudden braking or sharp turns.

7175377

# SAFETY

## Safety Labels and Locations

### Passenger Safety Warning

#### WARNING

#### PASSENGER SAFETY

To reduce the risk of SEVERE INJURY or DEATH

NEVER CARRY MORE THAN ONE PASSENGER

NEVER RIDE AFTER USING DRUGS OR ALCOHOL

**NEVER** carry a passenger too small to firmly plant feet on footrests and securely grasp hand holds.

THE PASSENGER MUST **ALWAYS**:

- use an approved helmet and protective gear
- securely grasp hand holds and plant feet firmly on footrests while seated in the passenger seat
- tell operator to slow down or stop if uncomfortable - get off and walk if conditions require

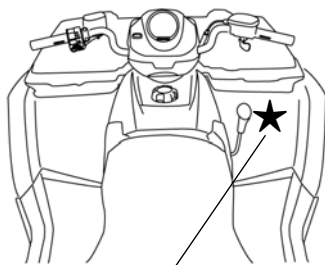

Passenger Safety  
Warning

7175379

## Safety Labels and Locations

### Tire Pressure/Load Warning

#### WARNING

Improper tire pressure or overloading can cause loss of control.

Loss of control can result in severe injury or death.

- Cold tire pressure:
  - Front: 5.0 psi (34.5 kPa)
  - Rear: 5.0 psi (34.5 kPa)
- Maximum weight capacity: 705 lbs. (320 kg)

7175441

Tire Pressure/Load  
Warning

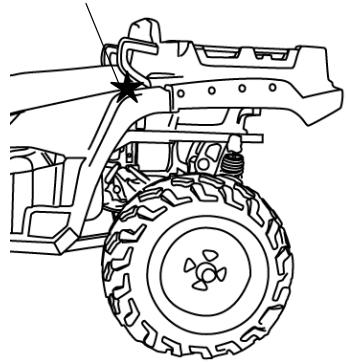

# SAFETY

## Safety Labels and Locations

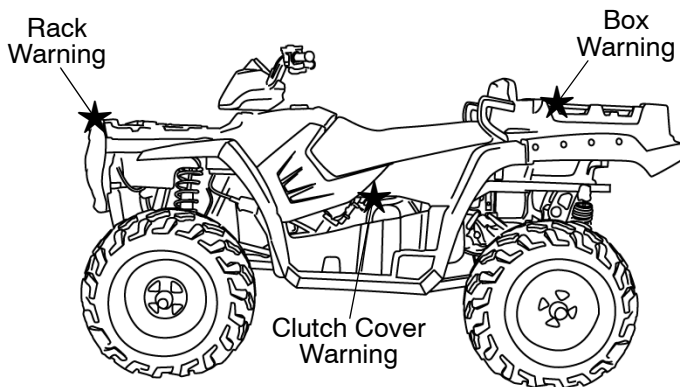

### Rack Warning, Front

#### WARNING

DO NOT TOW FROM RACK OR BUMPER. Vehicle damage or tipover may result causing severe injury or death. Tow only from tow hooks or hitch. Maximum combined Front Rack and Container Load: 90 lbs. (41 kg)

7174201

### Clutch Cover Warning

#### WARNING

#### NO STEP

- Moving parts hazard under belt-clutch guard. To prevent serious injury, do not operate vehicle with guard removed.
- Do not modify engine or clutch. Doing so can cause part failure, possible imbalance, and excessive engine RPM, which can result in serious injury or death.

7172563

## Safety Labels and Locations

### Reverse Override Warning/AWD Caution

#### WARNING

Improper use of override button can lead to loss of control resulting in severe injury or death. Do not activate override while throttle is engaged. Always apply throttle gradually while in reverse.

#### CAUTION

Do not push switch to engage 4x4 (AWD) if the rear wheels are spinning. This may cause severe drive shaft and clutch damage.

7175512

## Box Warning

#### WARNING

Remove flammable material containers from box before filling.



#### WARNING

Passengers can be thrown off. This can cause serious injury or death. Never carry passengers in cargo box. Maximum Box Load - 400 lbs. (181 kg)  
7173890

# FEATURES AND CONTROLS

## Switches

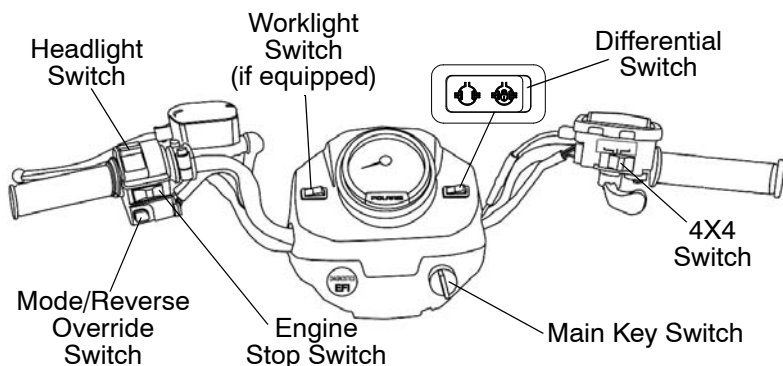

### Mode/Reverse Override Switch

This vehicle is equipped with a reverse speed limiter system. To gain additional wheel speed while backing, depress the override switch.

**WARNING!** Activating the override switch while the throttle is open can cause loss of control, which may result in serious injury or death. Always release the throttle before activating the override switch.

The override switch also allows activation of 4X4 in reverse, if the 4X4 switch is on. This switch is also used to toggle through the modes of the rider information center. See page 42.

### Engine Stop Switch

Move the stop switch either left or right to the OFF position to stop the engine quickly. The engine will not start or run when the switch is off.

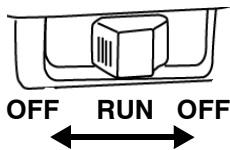

Both the main switch and the engine stop switch will shut off all electrical power to the vehicle, including lights.

### Main Key Switch

Use the main key switch to start the engine. See page 55.

### 4X4 Switch

Use the 4X4 switch to engage ADC 4X4, 4X4 or 2X4. See page 39.

# FEATURES AND CONTROLS

## Switches

### Differential Switch

Use the differential switch to lock and unlock the rear differential.



**Locked Differential:** Operate the vehicle with the switch in the locked position in most conditions.



**Unlocked Differential:** When the differential is unlocked, the inside wheel will rotate independently from the outside wheel during turns. Operate with an unlocked differential only as needed to protect smooth, level surfaces from tire damage. Otherwise, move the switch to the locked position. *This feature will function only if the vehicle is in 2X4 mode.*

**WARNING!** Operating with the differential unlocked (🔓) when on sloped, uneven, or loose terrain could cause loss of control and result in serious injury or death. One rear wheel may slip and lose traction or may lift up and grab when it touches the ground again.

DO NOT operate with the differential unlocked (🔓) when climbing or descending hills, when sidehilling, or when operating on uneven, loose, or slippery terrain such as sand, gravel, ice, snow, obstacles, and water crossings. Place the differential switch in the locked position and operate in ADC 4X4 or 4X4 on these types of terrain.

### Worklight Switch

Use the worklight switch (if equipped) to turn the worklight on or off. The worklight is located at the rear of the vehicle. Turn the light on while loading and unloading cargo in low light situations. Turn the worklight off when driving.

### Headlight Switch

Use the headlight switch to turn the lights on and off and to change the lights from high beam to low beam. The key must be in the ON position and the engine stop switch must be in the RUN position to operate the headlights.



# FEATURES AND CONTROLS

## Throttle Lever

### **⚠ WARNING**

Operating an ATV with sticking or improperly operating throttle controls could cause an accident. Never start or operate an ATV that has a sticking or improperly operating throttle. Always contact your dealer for service before operating the vehicle.

Failure to check or maintain proper operation of the throttle system can result in an accident if the throttle lever sticks during operation. Always check the lever for free movement and return before starting the engine. Also check occasionally during operation.

Modifications to the electronic throttle control could result in failure to perform as designed, which could result in an accident. Do not attempt to modify the throttle control system or replace it with any after market throttle mechanisms. Always ensure that the throttle cable is properly installed to the throttle control.

Engine speed and vehicle movement are controlled by pressing the throttle lever. The throttle lever is spring loaded. Engine speed returns to idle when the lever is released.

This ATV is equipped with Polaris Electronic Throttle Control (ETC), which is designed to reduce the risk of a frozen or stuck throttle. If the throttle cable should stick in an open position when the operator releases the throttle lever, the engine will stop, and power to the rear wheels will cease.

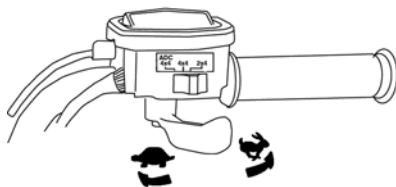

# FEATURES AND CONTROLS

## Brake Lever

### **⚠ WARNING**

Operating the ATV with a spongy brake lever can result in loss of braking, which could cause an accident. Never operate the ATV with a spongy-feeling brake lever. Always contact your dealer for service before operating the vehicle.

Squeeze the brake lever toward the handlebar to apply the front and rear brakes. These brakes are hydraulically activated disc type brakes that are activated by only one lever.

Always test brake lever travel and master cylinder fluid level before riding. When squeezed, the lever should feel firm. Any sponginess would indicate a possible fluid leak or low master cylinder fluid level, which must be corrected before riding. Contact your dealer for proper diagnosis and repairs.

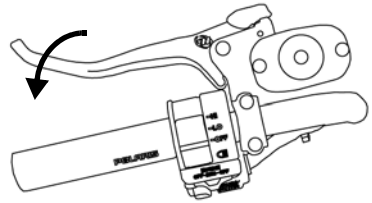

# FEATURES AND CONTROLS

## Master Cylinder/Brake Fluid

### **⚠ WARNING**

An over-full master cylinder may cause brake drag or brake lock-up, which could result in an accident. Maintain brake fluid at the recommended level. Do not overfill.

Never store or use a partial bottle of brake fluid. Brake fluid is hygroscopic, meaning it rapidly absorbs moisture from the air. The moisture causes the boiling temperature of the brake fluid to drop, which can lead to early brake fade and the possibility of brake failure, which could result in an accident. After opening a bottle of brake fluid, always discard any unused portion.

Check the brake fluid in the master cylinder before each ride.

1. Position the ATV on a level surface.
2. Position the handlebars so the master cylinder is level.
3. View the brake fluid level through the indicator window on the top of the master cylinder. The eye will appear dark when the fluid level is full. When fluid is low, the eye will be clear.
4. If the fluid level is low add DOT 4 brake fluid only. Do not overfill.

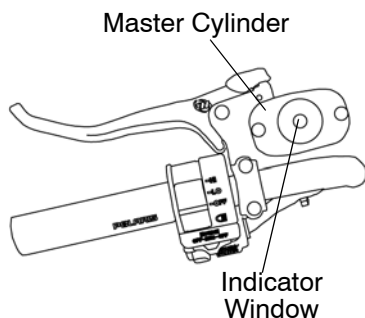

# FEATURES AND CONTROLS

## Parking Brake

### Locking the Parking Brake

1. Place the transmission in PARK.
2. Squeeze and release the brake lever two or three times, then squeeze and hold.
3. Push the parking brake lock forward to engage the lock.
4. Release the brake lever.
5. To release the parking brake lock, squeeze and release the brake lever. It will return to its unlocked position.

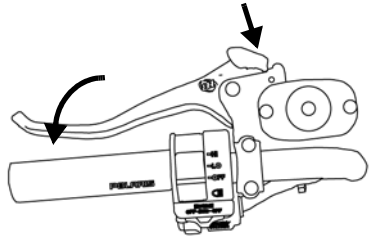

**WARNING!** Operating the ATV while the parking brake is engaged could result in an accident or fire. Always check to be sure the parking brake is disengaged before operating.

The parking brake may relax if left on for a long period of time. Always block the wheels to prevent rolling. Always block the wheels on the downhill side of the ATV if leaving it parked on a hill. Another option is to park the ATV in a sidehill position. Never depend on the parking brake alone if the ATV is parked on a hill. Always block the wheels to prevent rolling.

# FEATURES AND CONTROLS

## Auxiliary Foot Brake

### **⚠ WARNING**

Aggressively applying the auxiliary brake when backing down a hill may cause rear tipover, which could result in serious injury or death. Never back down a hill.

Use caution when applying the auxiliary brake. Do not aggressively apply the auxiliary brake when going forward. The rear wheels may skid and slide sideways, causing loss of control and serious injury or death.

The auxiliary brake system is intended to be used as a backup for the main brake system. Should the main system fail, use the auxiliary foot brake. Since this is a rear brake only, it will not be as effective as the all-wheel single lever system.

The auxiliary foot brake is located on the inside of the right footrest. Operate this brake with your right foot.

If the rear wheels slide while using the auxiliary brake, *reduce* brake pedal pressure to brake the rear wheels without skidding.

Auxiliary Foot Brake

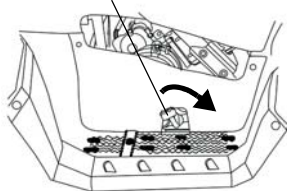

### **Brake Fluid Level**

Check the brake fluid level frequently for the auxiliary brake system. The reservoir is located under the seat. Maintain the fluid level between the maximum and minimum marks.

# FEATURES AND CONTROLS

## Automatic Transmission Gear Selector

The transmission gear selector is located on the right side of the vehicle.

H: High Gear

L: Low Gear

N: Neutral

R: Reverse

P: Park

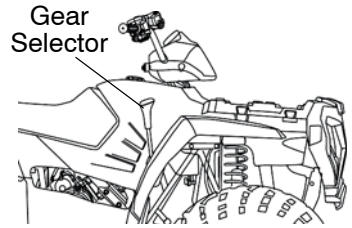

To shift gears, brake to a complete stop. When the engine is idling, move the lever to the desired gear.

**NOTICE:** Shifting gears with the engine speed above idle or while the vehicle is moving could cause transmission damage.

Whenever the ATV is left unattended, always place the transmission in PARK and lock the parking brake.

### Belt Life

To extend belt life, use low forward gear in heavy pulling situations and when operating at less than seven miles per hour for extended periods of time.

# FEATURES AND CONTROLS

## Fuel Filter (500 EFI)

The in-line fuel filter is located under the rubber service cover inside the front box. Have your dealer replace the filter after every 200 hours of operation and any time the fuel becomes contaminated with dirt or debris. Do not attempt to clean the fuel filter.

## Fuel Tank Cap

Remove the fuel tank cap to add fuel to the fuel tank. Use either leaded or unleaded gasoline with a minimum pump octane number of  $87=(R+ M/2)$  octane. *Do not use E-85 fuel.*



# FEATURES AND CONTROLS

## All Wheel Drive System

The All Wheel Drive system is controlled by the 4X4 switch.

### ADC 4X4 Mode

When the switch is on ADC 4X4, the ADC system allows engine braking to all four wheels when the vehicle descends a hill or incline. Always move the 4X4 switch to ADC 4X4 before ascending or descending a hill. See page 39.

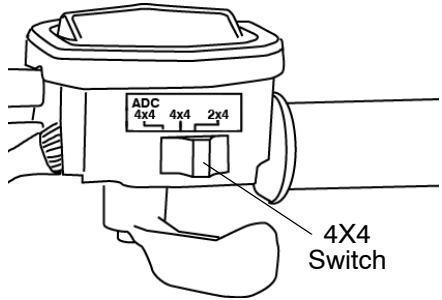

### 4X4 Mode

When the switch is on 4X4, the ATV is in 4X4, and the 4X4 indicator light in the instrument cluster will be on.

When in 4X4, the demand drive unit will automatically engage any time the rear wheels lose traction. When the rear wheels regain traction, the demand drive unit will automatically disengage. There is no limit to the length of time the vehicle may remain in 4X4.

**Tip:** The override switch allows activation of 4X4 in reverse if the 4X4 switch is on. See page 28.

### 2X4 Mode

When the switch is on 2X4, the ATV is in two-wheel drive at all times.



# FEATURES AND CONTROLS

## All Wheel Drive System

### Engaging 4X4

The 4X4 switch may be turned on or off while the vehicle is moving. Initially, the vehicle's electronic system will not enable 4X4 until the engine RPM is below 3100. Once enabled, 4X4 remains enabled until the 4X4 switch is turned off. If the switch is turned off while the demand drive unit is moving, it will not disengage until the rear wheels regain traction.

Engage the 4X4 switch before getting into conditions where front wheel drive may be needed. If the rear wheels are spinning, release the throttle before switching to 4X4.

**NOTICE:** Switching to 4X4 or ADC 4X4 while the rear wheels are spinning may cause severe drive shaft and gearcase damage. Always switch to 4X4 or ADC 4X4 while the rear wheels have traction or are at rest.

# FEATURES AND CONTROLS

## Active Descent Control (ADC) System

The ADC system allows engine braking to all four wheels when the vehicle descends a hill or incline. Always move the 4X4 switch to ADC 4X4 before ascending or descending a hill.

### Engaging Active Descent Control

The ADC system will automatically engage when *all four* of the following conditions occur:

- The 4X4 switch must be in the ADC 4X4 position
- Vehicle speed must be 15 mph (24 km/h) or less
- The throttle must be closed (throttle lever released)
- The transmission must be in gear (high, low or reverse)

### Disengaging Active Descent Control

The ADC system will automatically disengage if *at least one* of the following conditions occur:

- The 4X4 switch is moved out of the ADC 4X4 position
- Vehicle speed exceeds 15 mph (24 km/h)
- The throttle is open (throttle is applied)
- The transmission is shifted to neutral or park

# FEATURES AND CONTROLS

## Passenger Seat

Always make sure the passenger seat lock-out is functioning properly before operating with a passenger.

Do not operate the vehicle with the seat in the 2-up position when operating without a passenger. Always return the seat to the 1-up position for single-rider operation.

Never carry cargo in the rear box when operating the ATV in the 2-up mode with a passenger.

## Seat Conversion

1. Make sure the cargo box dump lever is securely latched.
2. Rotate both operator backrest latches 1/4 turn to release the locks.
3. Tilt the backrest slightly forward.
4. Pull the passenger backrest upward from the bed of the cargo box.

Operator Backrest Latches  
(view from front)

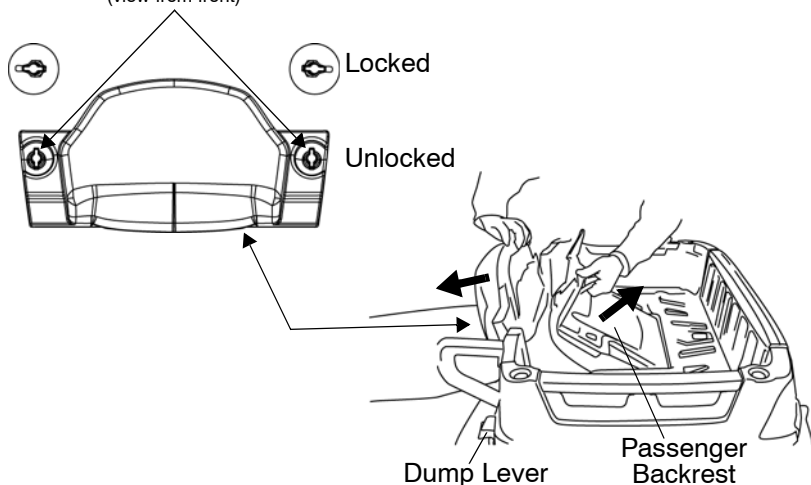

# FEATURES AND CONTROLS

## Passenger Seat Seat Conversion

5. Lift the adjustment latch at the top of the passenger backrest. Raise the backrest to the desired position. Release the latch, making sure it locks into one of the three operating positions.

**Tip:** The backrest must be moved out of the lowest position before it can be secured in the upright position. The lowest position is for seat storage only. Do not leave the backrest in the lowest position. Always adjust the backrest to one of the three operating positions.

6. Lower the operator backrest to create the passenger seat. Two retaining pins under the seat should fit into the two grommets on the seat base.

7. Test the passenger seat lock-out by attempting to release the cargo box dump lever. If the dump lever releases, the seat is not secure. Repeat the set-up procedure. *If the lock-out is not working properly, do not allow a passenger to ride the vehicle.* See your Polaris dealer for service.

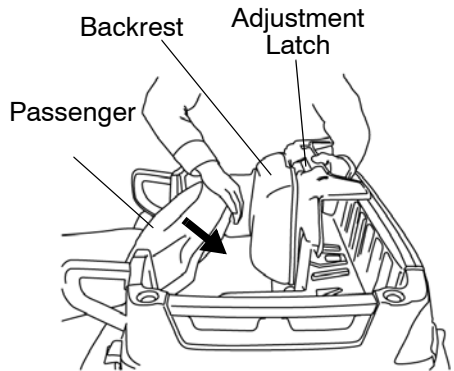

8. To return the vehicle to single-rider operation, reverse all steps. Always lower the passenger backrest to the lowest position before folding it down into the cargo box. Turn the operator backrest latches 1/4 turn to secure the locks.

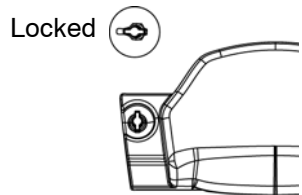

# FEATURES AND CONTROLS

## Instrument Cluster

Your ATV is equipped with an instrument cluster that senses vehicle speed from a sensor in the transmission. In addition to showing vehicle speed, the speedometer needle flashes when a warning condition exists.

The instrument cluster measures distance in miles as well as hours of operation. It also includes a reverse speed limiter function that limits the ATV's speed to approximately 7-9 mph. Refer to page 28 for additional information.

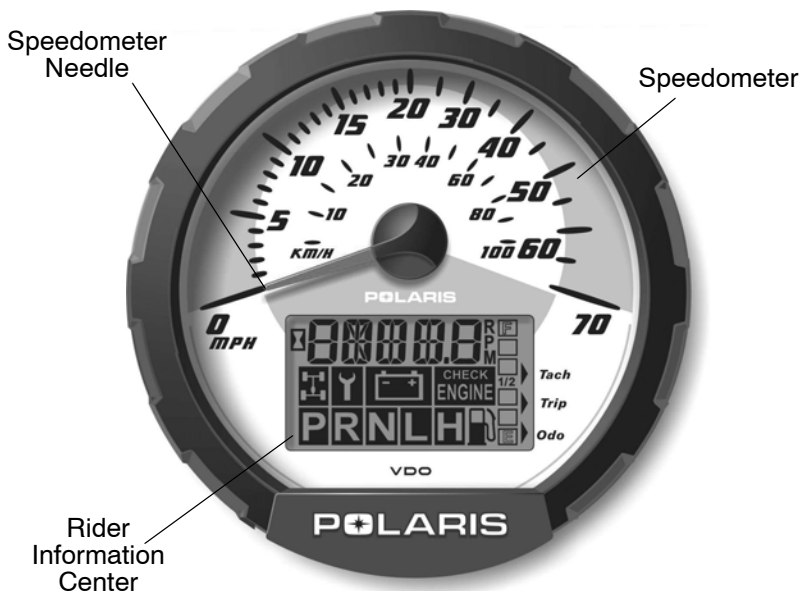

**NOTICE:** High water pressure may damage ATV components. Wash the ATV by hand or with a garden hose using mild soap.

Certain products, including insect repellents and chemicals, will damage the speedometer lens and other plastic surfaces. Do not use alcohol to clean the instrument cluster. Do not allow insect sprays to contact the lens. Immediately clean off any gasoline that splashes on the instrument cluster.

# FEATURES AND CONTROLS

## Instrument Cluster

### Rider Information Center

The rider information center is located in the instrument cluster. All segments will light up for 2.5 seconds at start-up. If the instrument cluster fails to illuminate, a battery over-voltage may have occurred and the instrument cluster may have shut off to protect the electronic speedometer. If this occurs, take the ATV to your Polaris dealer for proper diagnosis.

1. **Gear Indicator** - This indicator displays gear shifter position:

H = High Gear  
L = Low Gear  
N = Neutral  
R = Reverse Gear  
P = Park

2. **4X4 Indicator** - This indicator illuminates when the 4X4 switch is on either ADC 4X4 or 4X4.

3. **Engine Hour Display Indicator**

4. **Service Interval/Diagnostic Mode Indicator**

5. **Low Battery and Over Voltage** - This warning usually indicates that the ATV is operating at an RPM too low to keep the battery charged. It may also occur when the engine is at idle and high electrical load (lights, cooling fan, accessories) is applied. Drive at a higher RPM or recharge the battery to clear the warning.

6. **Odometer/Tachometer/Tripmeter/ Hour Meter/Clock**

7. **Fuel Gauge** - The segments of the fuel gauge show the level of fuel in the fuel tank. When the last segment clears, a low fuel warning is activated. All segments will flash, FUEL will display in the LCD, and the speedometer needle will blink. Refuel immediately.

8. **Check Engine Warning Indicator** - This indicator serves two purposes. The word HOT displays if the engine overheats. It also appears if an EFI-related fault occurs. Do not operate the ATV if this warning appears. Serious engine damage could result.

9. **Mode Indicator**

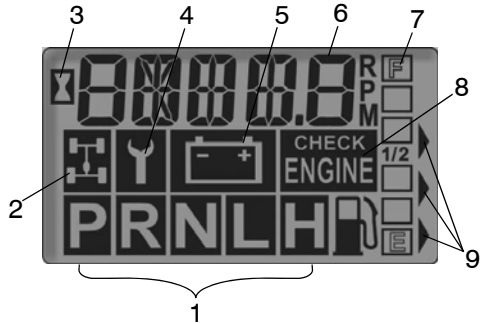

# FEATURES AND CONTROLS

## Instrument Cluster

### Rider Information Center

#### Standard Modes

Use the MODE button to toggle through the mode options. The reverse override button is also the MODE button. See page 28. The transmission cannot be in reverse when using this feature.

#### Odometer Mode

The odometer records the miles traveled by the ATV.

#### Trip Meter Mode

The trip meter records the miles traveled by the ATV on each trip if it's reset before each trip. To reset the trip meter, select the trip meter mode. Press and hold the mode button (override button) until the total changes to 0. In the Rider Information Center, the trip meter display contains a decimal point, but the odometer displays without a decimal point.

#### Hour Meter Mode

This mode logs the total hours the engine has been in operation.

#### Tachometer Mode

The engine RPM is displayed digitally. Small fluctuations in the RPM from day to day may be normal because of changes in humidity, temperature and elevation.

#### Clock Mode

The clock displays time in a 12-hour format. To reset the clock, see page 45.

# FEATURES AND CONTROLS

## Instrument Cluster

### Rider Information Center

#### Diagnostic Mode

The wrench icon will display when the gauge is in the diagnostic mode. To exit the diagnostic mode, turn the key switch off and on. Any movement of the tires will also cause the gauge to exit the diagnostic mode.

To enter the diagnostics mode:

1. Turn the key switch off and wait 10 seconds.
2. Lock the parking brake.
3. Place the transmission in neutral.
4. Hold the mode/reverse override button and turn the key switch on. Release the switch as soon as the display is activated.
5. Use the mode button to toggle through the diagnostic screens.

#### Clock Screen

To reset the clock:

1. Enter the diagnostic mode.
2. Toggle to the clock screen.
3. Press and hold the mode button until the hour display flashes. Release the button.
4. Press and release the mode button once to advance the setting by one hour. Press and *hold* the mode button to advance the hours quickly.
5. When the desired hour is displayed, wait approximately four seconds, until the minute display flashes.
6. Use the same procedure to reset the minutes.
7. When the display stops flashing, the mode has been set.
8. Do not turn the key switch off until the display stops flashing or the new setting will not be locked into the memory.



# FEATURES AND CONTROLS

## Instrument Cluster

### Rider Information Center

#### Diagnostic Mode

##### Battery Voltage Screen

View this screen to check battery voltage level.

##### Tachometer Screen

View the tachometer to check engine speed.

##### 4X4 Diagnostic Screen

The gauge indicates whether or not current is flowing through the all wheel drive coil. This screen is for informational purposes only. Please see your dealer for all major repairs.

##### Gear Circuit Diagnostic Screen

This screen displays the resistance value (in ohms) being read at the gear switch input of the gauge. This screen is for informational purposes only. Please see your dealer for all major repairs.

##### Programmable service interval

When the hours of engine operation equal the programmed service interval setting, the wrench icon will flash for 5 seconds each time the engine is started. When this feature is enabled, it provides a convenient reminder to perform routine maintenance. See page 47.

The service interval is programmed at 50 hours at the factory.

# FEATURES AND CONTROLS

## Instrument Cluster

### Rider Information Center

#### Diagnostic Mode

##### Programmable service interval

To enable or disable the service interval:

1. Enter the diagnostic mode.
2. Toggle to the service interval screen.
3. Press and hold the mode button for about 7 seconds, until either ON or OFF appears in the Rider Information Center, depending on your preference.

To reset the service interval:

1. Enter the diagnostic mode.
2. Toggle to the service interval screen.
3. Press and hold the mode button for 2-3 seconds, until the wrench icon flashes. Release the button.
4. Press and release the mode button once to advance the setting by one hour. Press and *hold* the mode button to advance the hours quickly.
5. If you scroll past the intended number, press and hold the button until the hours cycle back to zero.
6. When the desired setting is displayed, wait until the wrench icon stops flashing. The new service interval is now programmed.

#### Miles/Kilometers toggle

The display in the tripmeter and odometer can be changed to display either standard or metric units of measurement.

1. Enter the diagnostic mode.
2. Toggle to the screen that displays either kilometers (KM) or miles (MP).
3. Press and hold the mode button until the letters flash, then press and release the button once. When the display stops flashing, the mode has been set.

# FEATURES AND CONTROLS

## Instrument Cluster

### Rider Information Center

#### Downloading Codes

The EFI diagnostic mode is for informational purposes only. Please see your Polaris dealer for all major repairs.

See page 49 for Blink Codes and Failure Descriptions. Use the following procedure to download blink codes (failure codes) from the EFI module.

1. Place the transmission in PARK. Stop the engine. Turn the key switch to the ON position.
2. Turn the key switch off and on three times in less than five seconds. The word "WAIT" will appear on the screen.
3. The Check Engine icon will blink once, pause, then blink twice (blink code 12) to begin the diagnostic sequence. The EFI module is now searching for blink codes. If a code exists, the Check Engine icon will flash the code.
4. Count the number of times the Check Engine icon flashes.



*Example:* For the two blink codes 42 and 36, the Check Engine icon will flash 4 times, pause, then flash 2 times (code 42), then pause longer, blink 3 times, pause, and blink 6 times (code 36).

5. A code 61 will signal the end of the sequence. If no blink codes are found, only codes 12 and 61 will appear during the sequence.

**Tip:** The word "WAIT" will remain on the screen through this entire process.

#### Code Definitions

Open Load: There is a break in the wires that lead to the item listed in the chart (injector, fuel pump, etc.), or the item has failed.

Short-to-Ground: The wire is shorted to ground between the electronic control unit and the item listed in the chart.

Shorted Load: The wires leading to the item listed in the chart are shorted together, or the item has shorted internally.

Short-to-Battery: The wire leading from the item listed in the chart to the electronic control unit is shorted to a wire at battery voltage.

# FEATURES AND CONTROLS

## Instrument Cluster Rider Information Center Downloading Codes

Blink Code	Failure Description
12	BEGIN SEQUENCE
22	Throttle Position Sensor Low
22	Throttle Position Sensor High
22	Throttle Position Sensor Out of Adjustment
25	Gear Sensor Signal
31	System Voltage Low
31	System Voltage High
36	Ignition Coil A Prim/Sec Circuit Malfunction: Open Load/Short-to-Ground
36	Ignition Coil A Prim/Sec Circuit Malfunction: Shorted Load/Short-to-Battery
37	Ignition Coil B Prim/Sec Circuit Malfunction: Open Load/Short-to-Ground
37	Ignition Coil B Prim/Sec Circuit Malfunction: Shorted Load/Short-to-Battery
41	Air Temp Sensor Low Voltage
41	Air Temp Sensor High Voltage
42	Engine Coolant Temp Low Voltage
42	Engine Coolant Temp High Voltage
44	Crank Position Sensor Circuit Fault
45	Barometric Pressure/Manifold Air Pressure Sensor Low
46	Barometric Pressure/Manifold Air Pressure Sensor High
47	IAC Stepper Motor: Open Load
47	IAC Stepper Motor: Short-to-Ground
51	Injector Circuit Malfunction - Cyl 1: Open Load/Short-to-Ground
51	Injector Circuit Malfunction - Cyl 1: Shorted Load/Short-to-Battery
52	Injector Circuit Malfunction - Cyl 2: Open Load/Short-to-Ground
52	Injector Circuit Malfunction - Cyl 2: Shorted Load/Short-to-Battery
55	MIL Circuit: Open Load/Short-to-Ground
55	MIL Circuit: Shorted Load/Short-to-Battery
56	Fuel Pump: Open Load/Short-to-Ground
56	Fuel Pump: Shorted Load/Short-to-Battery
58	Fan Circuit: Open Load/Short-to-Ground
58	Fan Circuit: Shorted Load/Short-to-Battery
59	ADC: Open Load/Short-to-Ground
59	ADC: Shorted Load/Short-to-Battery
63	Starter Enable: Open Load/Short-to-Ground
63	Starter Enable: Shorted Load/Short-to-Battery
72	Gear Sensor Signal
73	4X4: Open Load/Short-to-Ground
73	4X4: Shorted Load/Short-to-Battery
74	Rear Differential Enable: Open Load/Short-to-Ground
74	Rear Differential Enable: Shorted Load/Short-to-Battery
61	END SEQUENCE

# OPERATION

## **WARNING**

Failure to operate the ATV properly can result in a collision, loss of control, accident or overturn, which may result in serious injury or death. Read and understand all safety warnings outlined in the safety section of this owner's manual.

## **Break-In Period**

The break-in period for your new Polaris ATV is the first ten hours of operation, or the time it takes to use the first two full tanks of gasoline. No single action on your part is as important as following the procedures for a proper break-in. Careful treatment of a new engine and drive components will result in more efficient performance and longer life for these components.

**NOTICE:** Excessive heat build-up during the first three hours of operation will damage close-fitted engine parts and drive components. Do not operate at full throttle or high speeds during the first three hours of use.

## **Break-In Period**

### **Engine and Drivetrain Break-in**

1. Fill the fuel tank with gasoline. See page 36. Always exercise extreme caution whenever handling gasoline.
2. Check the engine oil level on the dipstick. See page 80. Add oil if necessary to maintain the level between the safe and add marks.
3. Drive slowly at first. Select an open area that allows room to familiarize yourself with vehicle operation and handling.
4. Vary the throttle positions. Do not operate at sustained idle.
5. Perform regular checks on fluid levels, controls and areas outlined on the daily pre-ride inspection checklist. See page 52.
6. Pull only light loads.
7. Change both the oil and the filter at 20 hours or one month, whichever comes first.

### **PVT Break-in (Clutches/Belt)**

A proper break-in of the clutches and drive belt will ensure a longer life and better performance. Break in the clutches and belt by operating at slower speeds during the break-in period as recommended. Pull only light loads. Avoid aggressive acceleration and high speed operation during the break-in period.

# OPERATION

## Pre-Ride Checklist

Failure to inspect and verify that the ATV is in safe operating condition before operating increases the risk of an accident. Always inspect the ATV before each use to make sure it's in safe operating condition.

Item	Remarks	Page
Passenger seat lock-out	Ensure proper operation	40
Brake system/lever travel	Ensure proper operation	31 94
Brake fluid	Ensure proper level	32
Auxiliary brake	Ensure proper operation	34
Front suspension	Inspect, lubricate if necessary	79
Rear suspension	Inspect, lubricate if necessary	79
Steering	Ensure free operation	-
Tires	Inspect condition and pressure	97
Wheels/fasteners	Inspect, ensure fastener tightness	97 98
Frame nuts, bolts, fasteners	Inspect, ensure tightness	-
Fuel and oil	Ensure proper levels	36 80
Coolant level (if applicable)	Ensure proper level	92 93
Coolant hoses (if applicable)	Inspect for leaks	-
Throttle	Ensure proper operation	30 128
Indicator lights/switches	Ensure operation	28
Engine stop switch	Ensure proper operation	28
Air filter, pre-filter	Inspect, clean	99
Air box sediment tube	Drain deposits whenever visible	-
Headlamp	Check operation, apply Polaris dielectric grease when lamp is replaced	29 102
Brake light/taillight	Check operation, apply Polaris dielectric grease when lamp is replaced	105
Riding gear	Wear approved helmet, goggles, and protective clothing	8
ADC Fluid	Ensure proper level	90

## Safe Operation Practices

1. Complete the recommended safety training before operating this vehicle. See page 7.
2. Do not allow anyone under 16 years of age to operate this vehicle. Do not allow anyone with cognitive or physical disabilities to operate this vehicle.
3. Engine exhaust fumes are poisonous. Never start the engine or let it run in an enclosed area.
4. Before operating, learn how to use the auxiliary brake for emergency situations (if service brakes become inoperable).
5. Operate this vehicle off-road only. Never operate the vehicle on pavement or on any public street, road or highway, including dirt and gravel roads.
6. Use caution and drive at reduced speeds in conditions of reduced visibility such as fog, rain and darkness. Clean headlights frequently and replace burned out headlamps promptly.
7. Drive in a manner appropriate for your skills, your passenger's skills and operating conditions. Never operate at excessive speeds. Never attempt wheelies, jumps, or other stunts. Never remove your hands from the handlebars while operating, and always keep both feet on the footrests.
8. Never consume alcohol or drugs before or while operating an ATV.
9. Always use the size and type of tires specified for your vehicle. Always maintain proper tire pressure.
10. Never operate a damaged ATV. After any overturn or accident, have a qualified service dealer inspect the entire machine for possible damage.
11. Never operate the ATV on a frozen body of water.
12. Do not touch hot exhaust system components. Always keep combustible materials away from the exhaust system.
13. Always remove the ignition key when the vehicle is not in use to prevent unauthorized use.



## **OPERATION**

### **Know Your Riding Area/Tread Lightly**

Familiarize yourself with all laws and regulations concerning the operation of this off-road vehicle in your area. Respect the environment in which you ride. Find out where the designated riding areas are by contacting your Polaris dealer, a local riding club or local officials.

Help keep our trails open for recreational vehicle use. As an off-road enthusiast, you represent the sport and can set a good example (or a poor example) for others to follow. Tread lightly. Operate with respect for the terrain, avoid littering, and always stay on the designated trails.

### **Trail Etiquette**

Always practice good etiquette when riding. Allow a safe distance between your vehicle and other vehicles operating in the same area. Communicate to oncoming operators by signaling the number of vehicles in your group. When stopping, move your vehicle to the edge of the trail as far as possible to allow others to pass safely.

## Starting the Engine

1. Position the vehicle on a level surface outdoors or in a well-ventilated area.
2. Place the transmission in PARK.
3. Lock the parking brake.

**Tip:** The starter interlock will prevent the engine from starting if the transmission is in gear and the brake is not engaged.

4. Sit on the vehicle and move the engine stop switch to RUN.

**Tip:** Do not press the throttle while starting the engine.

5. Turn the ignition key past the ON position to engage the starter. Activate the starter for a maximum of five seconds, releasing the key when the engine starts.

**500 EFI ONLY:** *The starter will automatically stop if engaged for longer than 5 seconds. Move the key to the OFF position and wait 10 seconds before engaging the starter again.*

6. If the engine does not start, return the key to the OFF position and wait five seconds before attempting to start again. Activate the starter for another five seconds if necessary. Repeat this procedure until the engine starts.

**NOTICE:** Operating the vehicle immediately after starting could cause engine damage. Allow the engine to warm up for several minutes before operating the vehicle.

## Cold Weather Operation

If the ATV is used year-round, check the oil level frequently. A rising oil level could indicate the accumulation of contaminants such as water or excess fuel in the bottom of the crankcase. Water in the bottom of the crankcase can lead to engine damage and must be drained. Water accumulation increases as outside temperature decreases.

See your Polaris dealer for engine heater kits, which provide quicker warm-ups and easier starting in colder weather.

# OPERATION

## Driving Procedures



1. Wear protective riding gear. See page 8.
2. Perform the pre-ride inspection. See page 52.
3. Place the transmission in PARK.
4. Lock the parking brake.
5. Mount the vehicle from the left side.
6. Sit upright with both feet on the footrests and both hands on the handlebars.
7. Start the engine and allow it to warm up.
8. Shift the transmission into gear.
9. Check your surroundings and determine your path of travel.
10. Release the parking brake.
11. Slowly depress the throttle with your right thumb and begin driving.
12. Drive slowly. Practice maneuvering and using the throttle and brakes on level surfaces.

## Turning the Vehicle

Both rear wheels drive equally at all times (except when operating in 2X4 mode with the differential unlocked). This means that the outside wheel must travel a greater distance than the inside wheel when turning, and the inside tire must slip traction slightly.



1. Slow down.
2. Never turn quickly when carrying a passenger or cargo.
3. Steer in the direction of the turn.
4. Keep both feet on the footrests.
5. Lean your upper body to the inside of the turn while supporting your weight on the outer footrest. This technique alters the balance of traction between the rear wheels, allowing the turn to be made smoothly. The same leaning technique should be used for turning in reverse.
6. Practice making turns at slow speeds before attempting to turn at faster speeds.

**WARNING!** Turning improperly can result in vehicle overturn. Never turn abruptly or at sharp angles. Never turn at high speeds.

# OPERATION

## Driving with a Passenger

1. Never allow anyone under 12 years of age to ride as a passenger on this 2-up ATV. Make sure any passenger is tall enough to comfortably and safely reach the grab handles and footrests.
2. **Do not carry a passenger until you have at least two hours of driving experience with this vehicle.**
3. Make sure the passenger is wearing appropriate riding gear, including an approved helmet with a rigid chin guard. See page 8.
4. Perform the pre-ride inspection. See page 52.
5. Convert the seat for 2-up riding. See page 40. Always make sure the passenger seat lock-out is functioning properly before carrying a passenger.
6. Lock the parking brake.
7. Mount the vehicle from the left side. After the operator is seated, the passenger should mount the vehicle from the left side. Always make sure the brake is engaged to ensure the vehicle remains motionless whenever a passenger mounts or dismounts.
8. Allow a passenger to ride only in the approved passenger seat.
9. Never carry more than one passenger.
10. Slow down. Control may be more difficult with a passenger on board. Allow more time and distance for braking.



## Driving with a Passenger

11. Ride to the ability of your passenger, instead of to your own ability. Avoid unexpected or aggressive maneuvers that could cause a passenger to fall from the vehicle.
12. Do not cross a hillside with a passenger on board. See page 62.
13. A passenger should always be seated in the passenger seat with both feet on the footrests and both hands on the passenger grab handles at all times. The passenger should never hold on to the operator. Never secure a passenger to the vehicle or to the operator with a belt, rope or similar device.
14. Make sure the passenger understands the importance of "active riding." When hill-climbing or performing maneuvers, a passenger should shift body weight in the same manner in which the driver shifts body weight. For example, the passenger should lean to the inside of a turn along with the operator and should always lean uphill when climbing and descending hills.

# OPERATION

## Driving on Slippery Surfaces

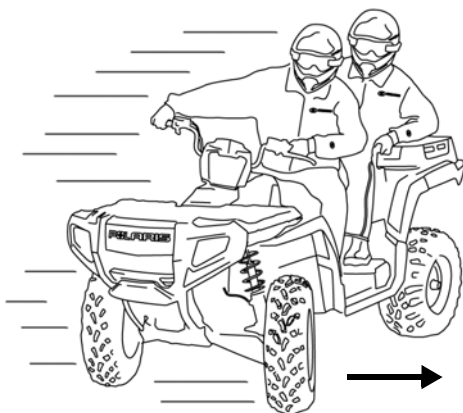

Whenever riding on slippery surfaces such as wet trails or loose gravel, or during freezing weather, follow these precautions:

1. Do not operate on excessively rough, slippery or loose terrain.
2. Slow down when entering slippery areas.
3. Engage 4X4 before wheels begin to lose traction.

**NOTICE:** Severe damage to drive train may occur if the 4X4 is engaged while the wheels are spinning. Allow the rear wheels to stop spinning before engaging 4X4, or engage 4X4 before wheels begin to lose traction.

4. Maintain a high level of alertness, reading the trail and avoiding quick, sharp turns, which can cause skids.
5. Never apply the brakes during a skid. Correct a skid by turning the handlebars in the direction of the skid and shifting your body weight forward.

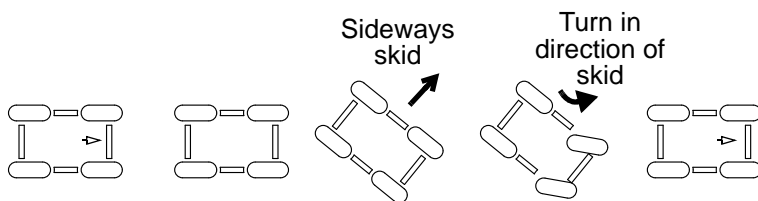

## Driving Uphill

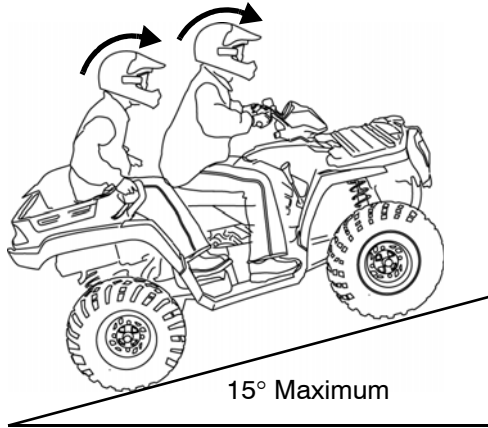

Braking and handling are greatly affected when operating in hilly terrain. Improper procedure could cause loss of control or overturn. Whenever traveling uphill, follow these precautions:

1. Always move the 4X4 switch to ADC 4X4 before ascending or descending a hill. See page 39.
2. Never operate with the differential unlocked (🔓) while operating on a hill or other irregular terrain. See pages 29 and 39.
3. Drive straight uphill.
4. Avoid steep hills (15° maximum).
5. Always check the terrain carefully before ascending any hill.
6. Never climb hills with excessively slippery or loose surfaces.
7. Keep both feet on the footrests.
8. Shift body weight uphill. A passenger should also shift body weight uphill.
9. Proceed at a steady rate of speed and throttle opening. Opening the throttle suddenly could cause the ATV to flip over backwards.
10. Never go over the top of any hill at high speed. An obstacle, a sharp drop, or another vehicle or person could be on the other side of the hill.
11. Remain alert and be prepared to take emergency action. This may include quick dismounting of the vehicle.



# OPERATION

## Driving on a Sidehill (Sidehilling)



Driving on a sidehill is not recommended. Improper procedure could cause loss of control or overturn. Avoid crossing the side of any hill unless absolutely necessary.

If crossing a sidehill is *unavoidable*, follow these precautions:

1. Slow down.
2. Avoid crossing the side of a steep hill.
3. If operating in 2X4 mode, make sure the differential is locked.
4. Do not cross a hillside with a passenger on board. Ask the passenger to dismount and walk across the hillside before remounting the vehicle.
5. Lean into the hill, transferring your upper body weight toward the hill while keeping your feet on the footrests.
6. If the vehicle begins to tip, quickly turn the front wheel downhill, if possible, or dismount on the uphill side *immediately!*

## Driving Downhill

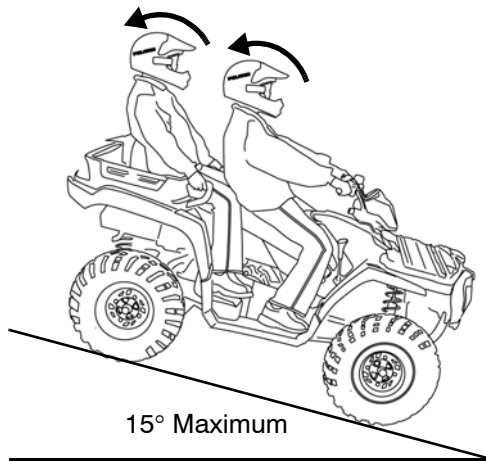

When driving downhill, follow these precautions:

1. Always check the terrain carefully before descending a hill.
2. Always move the 4X4 switch to ADC 4X4 before ascending or descending a hill. See page 39.
3. Always descend a hill with the transmission in forward gear. Do not descend a hill with the transmission in neutral.
4. Slow down. Never travel down a hill at high speed.
5. Drive straight downhill. Avoid traveling down a hill at an angle, which would cause the vehicle to lean sharply to one side.
6. Shift body weight uphill. A passenger should also shift body weight uphill.
7. Apply the brakes *slightly* to aid in slowing. Applying the brakes too firmly may cause the rear wheels to lock, which could result in loss of control.

# OPERATION

## Turning Around on a Hill (K-Turn)

If the vehicle stalls while climbing a hill, never back it down the hill!  
Use the K-turn to turn around.

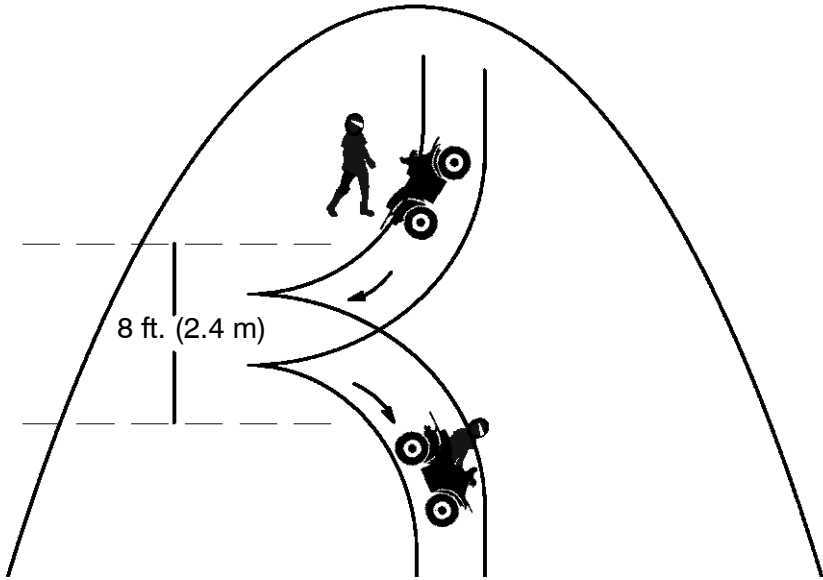

## Turning Around on a Hill (K-Turn)

1. Stop and lock the parking brake while keeping body weight uphill.
2. Always move the 4X4 switch to ADC 4X4 before ascending or descending a hill. See page 39.
3. Leave the transmission in forward and shut off the engine.
4. If a passenger is on board, ask the passenger to dismount first, then the operator may dismount. Dismount on the uphill side of the vehicle, or on the left if the vehicle is pointing straight uphill. *A passenger should not remount until the vehicle returns to firm, level ground.*
5. Staying uphill of the vehicle, turn the handlebars full left.
6. While holding the brake lever, release the parking brake lock and slowly allow the vehicle to roll around to your right until it's pointing across the hill or slightly downward.
7. Lock the parking brake. Remount the vehicle from the uphill side, keeping body weight uphill.
8. Start the engine with the transmission still in forward.
9. Release the parking brake and proceed *slowly*, controlling speed with the brake lever, until the vehicle is on more level ground.

# OPERATION

## Driving Through Water

Your ATV can operate through water with a maximum recommended depth equal to the bottom of the footrests. Follow these procedures when operating through water:

1. Determine water depths and current before entering water.
2. Choose a crossing where both banks have gradual inclines.
3. Avoid operating through deep or fast-flowing water.



**NOTICE:** Major engine damage can result if the vehicle is not thoroughly inspected after operation in water. Perform the services outlined in the maintenance chart. See page 75. The following areas need special attention: engine oil, transmission oil, demand drive fluid and all grease fittings.

If the vehicle tips or overturns in water, or if the engine stops during or after operating in water, restarting can result in serious engine damage. Transport the vehicle to your dealer for service before restarting the engine. If this is not possible, follow the vehicle immersion inspection and drying procedures outlined on page 108, then see your dealer for service at the first opportunity.

4. After leaving water, test the brakes. Apply them lightly several times while driving slowly. The friction will help dry out the pads.

*If it's unavoidable to enter water deeper than the footrest level:*

- Proceed slowly. Avoid rocks and obstacles.
- Balance your weight carefully. Avoid sudden movements.
- Maintain a steady rate of speed. Do not make sudden turns or stops. Do not make sudden throttle changes.

## Driving Over Obstacles

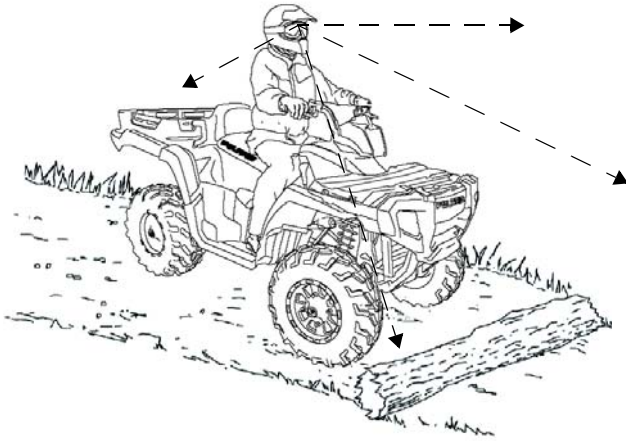

Follow these precautions when operating over obstacles:

1. Always check for obstacles before operating in a new area.
2. Look ahead and learn to read the terrain. Be constantly alert for hazards such as logs, rocks and low hanging branches.
3. Travel slowly and use extra caution when operating on unfamiliar terrain. Not all obstacles are immediately visible.
4. Never attempt to operate over large obstacles, such as rocks or fallen trees.
5. Always have a passenger dismount before operating over an obstacle that could cause a fall from the vehicle or vehicle tipover.

# OPERATION

## Driving in Reverse

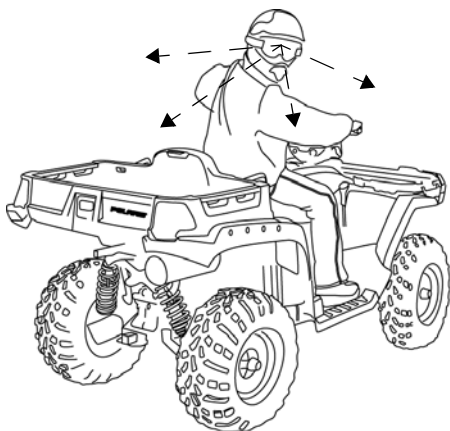

Follow these precautions when operating in reverse:

1. Always check for obstacles or people behind the vehicle. Be aware that a passenger can obstruct your view.
2. Always avoid backing downhill.
3. Back slowly.
4. Apply the brakes *lightly* for stopping.
5. Avoid turning at sharp angles.
6. Never open the throttle suddenly.
7. Do not use the override switch unless additional wheel speed is required for vehicle movement. Use the override with caution as rearward vehicle speed is greatly increased. Do not operate at wide open throttle. Operate the throttle just enough to maintain a desired speed.

**NOTICE:** Excessive throttle operation while in the speed limit mode may cause fuel to build in the exhaust, resulting in engine popping and/or engine damage.

## Parking on an Incline

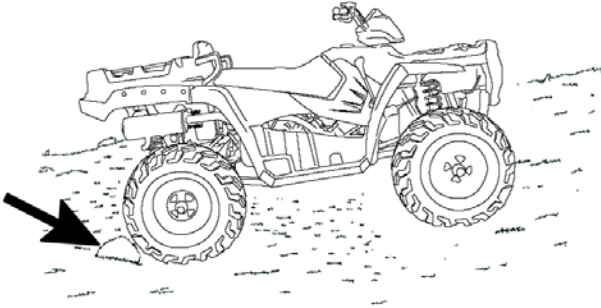

Avoid parking on an incline if possible. If it's unavoidable, follow these precautions:

1. Stop the engine.
2. Place the transmission in PARK.
3. Lock the parking brake.
4. Always block the rear wheels on the downhill side.



# OPERATION

## Hauling Cargo

### **⚠ WARNING**

Overloading the vehicle or carrying or towing cargo improperly can alter vehicle handling and may cause loss of control or brake instability. Always follow these precautions when hauling cargo:

Never carry cargo in the rear box when operating the ATV in the 2-up mode with a passenger.

**REDUCE SPEED AND ALLOW GREATER DISTANCES FOR BRAKING WHEN HAULING CARGO.**

**NEVER EXCEED THE MAXIMUM WEIGHT CAPACITY** of the vehicle. When determining the weight you are adding to the vehicle, include the weight of the operator, passenger, accessories, loads in the rack or box and the load on the trailer tongue. The combined weight of these items must not exceed the maximum weight capacity.

**REDUCE SPEED AND CARGO** to maintain stable driving conditions when operating over rough or hilly terrain.

**WEIGHT DISTRIBUTION** in the cargo bed should be as far forward and as low as possible. Carrying a high load raises the center of gravity and creates a less stable operating condition. Reduce load weight when cargo is high. When handling off-centered loads that cannot be centered, secure the load and operate with extra caution.

**SECURE ALL LOADS BEFORE OPERATING.** Unsecured loads may shift and create unstable operating conditions, which could result in loss of control of the vehicle. Always be sure that the cargo bed is lowered and latched before moving the vehicle.

**USE EXTREME CAUTION** when operating with loads extending beyond the rack or cargo bed. Stability and maneuverability may be adversely affected, causing the machine to overturn.

**BALANCE LOADS** proportionally between the front rack and cargo bed, but do not exceed the stated load capacity. Carrying a load on only the front rack or cargo bed may cause an imbalanced condition and increases the possibility of vehicle overturn.

**USE EXTREME CAUTION** when applying brakes with a loaded vehicle. Avoid terrain or situations that may require backing downhill.

Always attach the tow load to the hitch point.

**DO NOT TRAVEL FASTER THAN THE RECOMMENDED SPEEDS.** The vehicle should never exceed 10 mph (16 kph) while towing a load on a level surface. Vehicle speed should never exceed 5 mph (8 kph) when towing loads in rough terrain, while cornering, or while ascending or descending a hill.

**DO NOT BLOCK THE FRONT HEADLIGHT BEAM** when carrying loads on the front rack.

## Hauling Cargo

Never exceed the weight capacities specified for your ATV on warning labels and in the specifications section of this manual.

Cargo weight should be mounted as low as possible. When operating over rough or hilly terrain, reduce speed and cargo weight to maintain stable driving conditions.

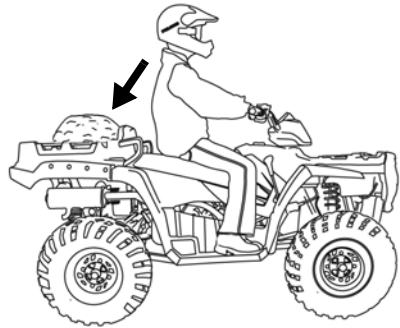

1. Always load the cargo box with the load as far forward as possible.
2. Do not obstruct the headlight beam with cargo.
3. Use low forward gear when hauling or towing heavy cargo to extend belt life.
4. Always operate the vehicle with extreme caution whenever hauling or towing loads. Balance, handling, and control may be affected.
5. Slow down.
6. Make sure the cargo box dump latch is securely latched before loading and operating. Unintentional dumping will result if weight is placed in the rear of the box and the latch is not secured.

# OPERATION

## Hauling Cargo

### Towing Loads

Always attach a towed load to the hitch point. Remove the hitch from the ATV when not towing a trailer. If towing a load, reduce rear rack cargo weight by the amount of tongue weight.

- The combination of rear rack cargo weight and tongue weight must not exceed the rear rack capacity.
- The total load (operator, passenger, accessories, cargo and weight on hitch) must not exceed the maximum weight capacity of the vehicle.

**NOTICE:** Using an improper hitch or exceeding the maximum tongue weight capacity can result in serious damage to the vehicle and will void your ATV warranty. Never install a hitch longer than 4" (10 cm). Never install automotive accessories on your Polaris ATV. Always install Polaris-approved (or equivalent) accessories designed for ATV use.

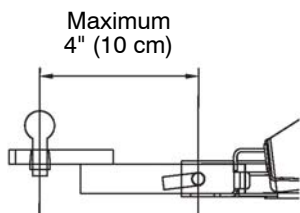

### Maximum Towing Capacities

Do not exceed the following maximum capacities when towing. Avoid towing on inclines.

	<b>500 EFI</b>	<b>800 EFI</b>
Maximum Towed Load (Level Ground)	1225 lbs. (557 kg)	1500 lbs. (680 kg)
Maximum Vertical Hitch Weight	120 lbs. (55 kg)	150 lbs. (68 kg)

## Hauling Cargo

### Dumping Cargo

1. Select a level site to dump the cargo box. Do not attempt to dump or unload the vehicle while parked on an incline.
2. Place the transmission in PARK.
3. Lock the parking brake.
4. Dismount the vehicle.
5. Lower the tailgate.

**WARNING!** If cargo weight is placed toward the rear of the cargo box, the load may dump unexpectedly and cause serious injury. When loading cargo, always position the weight as far forward and as low as possible.

6. Pull the cargo box release lever upward.
7. Lift the front of the cargo box and dump the cargo.
8. Lower the cargo box and make sure the release latch is secured.
9. Secure the tailgate.

**WARNING!** Operating with the cargo box in the raised position can cause serious injury and damage to the vehicle. The cargo box could close unexpectedly and injure the driver. The rear tires will also catch the rear of the bed, damaging the vehicle and creating hazardous driving conditions. Never operate this vehicle with the cargo box in the raised position.

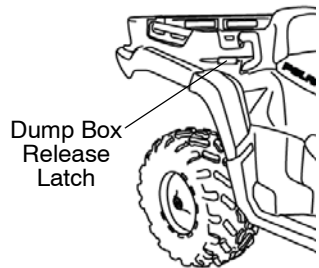

# **EMISSION CONTROL SYSTEMS**

## **Noise Emission Control System**

Do not modify the engine, intake or exhaust components, as doing so may affect compliance with U.S.A. EPA noise control requirements (40 CFR 205) and local noise level requirements.

## **Operation on Public Lands in the U.S.A.**

Your Polaris vehicle has a spark arrestor that was tested and qualified to be in accordance with the USDA Forest Service Standard 5100-1C. Federal law requires that this spark arrestor be installed and functional when the vehicle is operated on public lands.

Operation of off-road vehicles on public lands in the U.S.A. is regulated by 43 CFR 8343.1(c). Violations are subject to monetary penalties. Federal regulations can be viewed online at [www.gpoaccess.gov/ecfr/](http://www.gpoaccess.gov/ecfr/).

## **Crankcase Emission Control System**

This engine is equipped with a closed crankcase system. Blow-by gases are forced back to the combustion chamber by the intake system. All exhaust gases exit through the exhaust system.

## **Exhaust Emission Control System**

Exhaust emissions are controlled by engine design. An electronic fuel injection (EFI) system controls fuel delivery. The engine and EFI components are set at the factory for optimal performance and are not adjustable.

The emissions label is located on the battery box.

## **Electromagnetic Interference**

This spark ignition system complies with Canadian ICES-002.

This vehicle complies with the EMC requirements of European directives 97/24/EC and 2004/108/EC.

## Periodic Maintenance Chart

Careful periodic maintenance will help keep your vehicle in the safest, most reliable condition. Inspection, adjustment and lubrication of important components are explained in the periodic maintenance chart.

Inspect, clean, lubricate, adjust and replace parts as necessary. When inspection reveals the need for replacement parts, use genuine Polaris parts available from your Polaris dealer.

Record maintenance and service in the Maintenance Log beginning on page 144.

Service and adjustments are important for proper vehicle operation. If you're not familiar with safe service and adjustment procedures, have a qualified dealer perform these operations.

Maintenance intervals in the following chart are based upon average riding conditions and an average vehicle speed of approximately 10 miles per hour. Vehicles subjected to severe use must be inspected and serviced more frequently.

### Severe Use Definition

- Frequent immersion in mud, water or sand
- Racing or race-style high RPM use
- Prolonged low speed, heavy load operation
- Extended idle
- Short trip cold weather operation

Pay special attention to the oil level. A rise in oil level during cold weather can indicate contaminants collecting in the oil sump or crankcase. Change oil immediately if the oil level begins to rise. Monitor the oil level, and if it continues to rise, discontinue use and determine the cause or see your dealer.

# MAINTENANCE

## Periodic Maintenance Chart

### WARNING

Improperly performing the procedures marked with a ■ could result in component failure and cause an accident, which may result in serious injury or death. Always have an authorized Polaris dealer perform these services.

### Maintenance Chart Key

- ▶ Perform these operations more often for vehicles subjected to severe use.
- E Emission-related service  
(Failure to conduct this maintenance will not void the emissions warranty but may affect emissions.)
- Have an authorized Polaris dealer perform these services.

*Perform all services at whichever maintenance interval is reached first.*

Item	Maintenance Interval (whichever comes first)			Remarks
	Hours	Calendar	Miles (Km)	
Steering	-	Pre-Ride	-	Make adjustments as needed. See Pre-Ride Checklist on page 52.
Front suspension	-	Pre-Ride	-	
Rear suspension	-	Pre-Ride	-	
Tires	-	Pre-Ride	-	
Brake fluid level	-	Pre-Ride	-	
Brake lever travel	-	Pre-Ride	-	
Brake system	-	Pre-Ride	-	
Passenger seat lock-out	-	Pre-Ride	-	
Wheels/fasteners	-	Pre-Ride	-	
Frame fasteners	-	Pre-Ride	-	
Engine oil level	-	Pre-Ride	-	
▶ E Air filter, pre-filter	-	Daily	-	Inspect; clean often; replace as needed
▶ Air box sediment tube	-	Daily	-	Drain deposits when visible
Coolant (if applicable)	-	Daily	-	Check level daily, change coolant every 2 years
▶ ADC fluid (ADC models)	-	Daily	-	Check level daily, add as needed
Headlight/taillight/ worklight	-	Daily	-	Check operation; apply dielectric grease if replacing lamps

# MAINTENANCE

## Periodic Maintenance Chart

	Item	Maintenance Interval (whichever comes first)			Remarks
		Hours	Calendar	Miles (Km)	
▶ E	Air filter, main element	-	Weekly	-	Inspect; replace as needed
▶ ■	Brake pad wear	10 H	Monthly	100 (160)	Inspect periodically
	Battery	20 H	Monthly	200 (320)	Check terminals; clean; test
▶	Rear gearcase oil (if equipped)	25 H	Monthly	250 (400)	Inspect level; change yearly
▶	Transmission oil	25 H	Monthly	250 (400)	Inspect level; change yearly
▶	Demand drive fluid	25 H	Monthly	250 (400)	Inspect level; change yearly
▶ E	Engine breather filter (if equipped)	25 H	Monthly	250 (400)	Inspect; clean if needed
▶	General lubrication	50 H	3 M	500 (800)	Lubricate all fittings, pivots, cables, etc.
	Shift linkage	50 H	6 M	500 (800)	Inspect, lubricate
■	Steering	50 H	6 M	500 (800)	Lubricate
▶	Front suspension	50 H	6 M	500 (800)	Lubricate
▶	Rear suspension	50 H	6 M	500 (800)	Lubricate
■ E	Throttle Cable/ ETC Switch	50 H	6 M	500 (800)	Inspect; adjust; lubricate; replace if necessary
E	Throttle Body Intake Duct	50 H	6 M	500 (800)	Inspect duct for proper seal- ing/air leaks
	Drive belt	50 H	6 M	500 (800)	Inspect; adjust; replace as needed
	Cooling system (if applicable)	50 H	6 M	1000 (1600)	Inspect coolant strength seasonally; pressure test system yearly
▶	Engine oil change	100 H	6 M	1000 (1600)	Perform a break-in oil change at one month
▶	Oil filter change	100 H	6 M	1000 (1600)	Replace with oil change



# MAINTENANCE

## Periodic Maintenance Chart

	Item	Maintenance Interval (whichever comes first)			Remarks
		Hours	Calendar	Miles (Km)	
■ E	Valve clearance	100 H	12 M	1000 (1600)	Inspect; adjust
	Fuel system	100 H	12 M	1000 (1600)	Check for leaks at tank cap, lines, filter, pump; replace lines every two years
▶	Radiator (if applicable)	100 H	12 M	1000 (1600)	Inspect; clean external surfaces
▶	Cooling hoses (if applicable)	100 H	12 M	1000 (1600)	Inspect for leaks
▶	Engine mounts	100 H	12 M	1000 (1600)	Inspect
	Exhaust muffler/ pipe	100 H	12 M	1000 (1600)	Inspect
■ E	Spark plug	100 H	12 M	1000 (1600)	Inspect; replace as needed
▶	Wiring	100 H	12 M	1000 (1600)	Inspect for wear, routing, security; apply dielectric grease to connectors subjected to water, mud, etc.
■	Clutches (drive and driven)	100 H	12 M	1000 (1600)	Inspect; clean; replace worn parts
■	Front wheel bearings	100 H	12 M	1000 (1600)	Inspect; replace as needed
■	Brake fluid	200 H	24 M	2000 (3200)	Change every two years
■	ADC fluid (ADC models)	200 H	24 M	2000 (3200)	Change every two years
▶ ■ E	Fuel filter	200 H	24 M	2000 (3200)	Check for leaks around lines. Replace every 2 years, more often under extreme conditions.
	Spark arrestor	300 H	36 M	3000 (4800)	Clean out
■	Toe adjustment	-			Inspect periodically; adjust when parts are replaced
	Headlight aim	-			Adjust as needed

▶ Perform these procedures more often for vehicles subjected to severe use.

E Emission-Related Service

■ Have an authorized Polaris dealer perform these services.

## Lubrication Guide

Check and lubricate all components at the intervals outlined in the Periodic Maintenance Chart beginning on page 75. Items not listed in the chart should be lubricated at the General Lubrication interval.

The a-arms and upper control arms are lubricated at the factory, and no additional lubrication will be needed. However, if these components are subjected to severe use, grease zerks have been provided for additional lubrication at the user's discretion.

Item	Lube	Capacity at Fluid Change	Inspection Procedure
Engine Oil	PS-4 PLUS Performance Synthetic 2W-50	2 qt. (1.9 l)	See page 80.
Brake Fluid	DOT 4 Only	---	See page 32.
Transmission Oil	Polaris AGL Synthetic Gearcase Lube	32 oz. (948 ml)	See page 88.
Demand Drive Fluid (Front Gearcase)	Demand Drive LT Premium Fluid	9.3 oz. (275 ml)	See page 89.
ADC Fluid	Polaris ADC Fluid	---	See page 90.
Front Prop Shaft Yoke	Polaris Premium U-Joint Lube	---	Grease fittings (3 pumps maximum) every 500 miles, before long periods of storage, or after pressure washing or submerging.

Front Prop Shaft Yoke

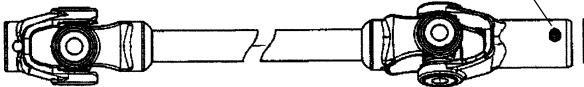

# MAINTENANCE

## Engine Oil

### Oil Recommendations

Polaris recommends the use of Polaris PS-4 *PLUS Performance* Synthetic 2W-50 4-cycle oil or a similar oil for this engine. See page 79.

Oil may need to be changed more frequently if Polaris oil is not used. Always use 2W-50 oil. Follow the manufacturer's recommendations for ambient temperature operation. See page 133 for the part numbers of Polaris products.

**NOTICE:** Mixing brands or using a non-recommended oil may cause serious engine damage. Always use the recommended oil. Never substitute or mix oil brands.

## Engine Oil

### Oil Level (500 EFI)

Access the oil dipstick and fill tube from the left side of the ATV.

**Tip:** A rising oil level between checks in cool weather driving can indicate contaminants such as gas or moisture collecting in the crankcase. If the oil level is over the full/safe mark, change the oil immediately.

1. Position the vehicle on a level surface.
2. Start the engine. Allow it to idle for 20-30 seconds. Stop the engine.
3. Remove the dipstick. Wipe it dry with a clean cloth.
4. Reinstall the dipstick completely.
5. Remove the dipstick and check the oil level. Maintain the oil level in the safe range. Do not overfill.
6. Reinstall the dipstick securely.

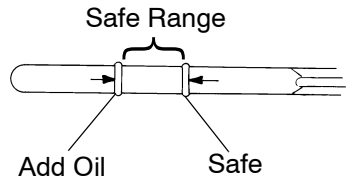
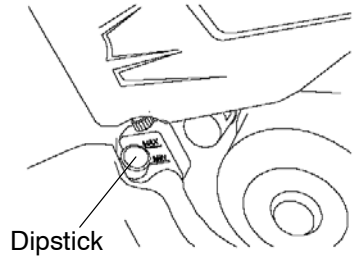

# MAINTENANCE

## Engine Oil

### Oil Level (800 EFI)

Access the oil dipstick and fill tube from the left side of the ATV.

1. Position the vehicle on a level surface.
2. Lift the lever lock to remove the dipstick. Wipe it dry with a clean cloth.
3. Reinstall the dipstick completely, but do not lock it. The dipstick must be inserted completely to keep the angle and depth of the stick consistent.
4. Remove the dipstick and check the oil level. Maintain the oil level in the safe range. Do not overfill.

**Tip:** Due to the dipstick entry angle into the crankcase, the oil level will read higher on the bottom side of the dipstick. Always read the level on the upper surface of the dipstick.

5. After reinstalling the dipstick, seat the lever lock.

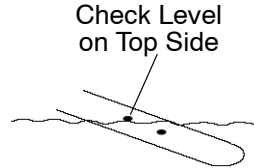
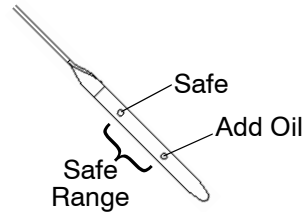
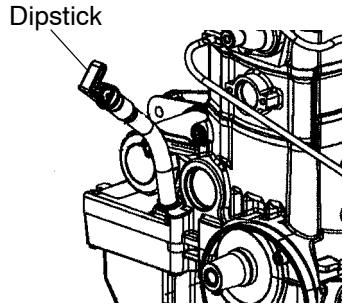

## Engine Oil

### Oil and Filter Change (500 EFI)

Always change the oil and filter at the intervals outlined in the Periodic Maintenance Chart beginning on page 75.

1. Position the vehicle on a level surface.
2. Start the engine. Allow it to idle for two to three minutes.
3. Stop the engine.
4. Clean the area around the drain plug.
5. Place a drain pan under the oil tank.
6. Remove the drain plug. Allow the oil to drain completely.

**CAUTION!** Hot oil can cause burns to skin. Do not allow hot oil to contact skin.

7. Install a new sealing washer on the drain plug. The sealing surfaces on drain plug and crankcase should be clean and free of burrs, nicks or scratches.
8. Reinstall the drain plug. Torque to 14-17 ft. lbs. (19-23 Nm).
9. Disconnect the lower oil delivery hose and remove the screen fitting from the oil tank. Clean the fitting.

**Tip:** The fitting threads must be sealed with LOCTITE PST 505 or PTFE seal tape.

10. Reinstall the screen fitting and rotate the fitting clockwise a minimum of 2 1/2 turns into the tank threads. Continue to rotate the fitting until the nipple of the fitting aligns with the mark on the tank.

**Tip:** Do not over-tighten. Maximum torque for the screen fitting is 25 ft. lbs. (34 Nm).

11. Reattach the oil line.

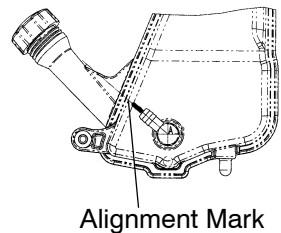
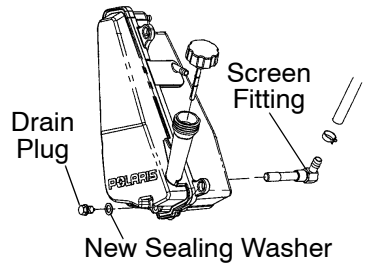

# MAINTENANCE

## Engine Oil

### Oil and Filter Change (500 EFI)

12. Place shop towels beneath the oil filter. Using an oil filter wrench, turn the filter counterclockwise to remove it.
13. Make sure the o-ring from the old filter is completely removed from the engine. Using a clean dry cloth, clean the filter sealing surface on the crankcase.
14. Lubricate the o-ring on the new filter with a film of fresh engine oil. Check to make sure the o-ring is in good condition.
15. Install the new filter and rotate it clockwise by hand until the filter gasket contacts the sealing surface, then turn it an additional 1/2 turn.
16. Approximately one cup of engine oil will remain in the crankcase. To drain, remove the drain plug on the lower right side of the crankcase.
17. Reinstall the drain plug. The sealing surfaces on the drain plug and crankcase should be clean and free of burrs, nicks or scratches.
18. Torque to 14 ft. lbs. (19 Nm).
19. Remove the dipstick.
20. Add two quarts (1.9 l) of recommended oil. If the sump is not drained, add about 1 3/4 quarts (1.6 l) initially.
21. Reinstall the dipstick.
22. Place the transmission in PARK.
23. Lock the parking brake.
24. **Prime the oil pump using the procedure on page 85.** Then stop the engine and inspect for leaks.
25. Check the oil level. Add oil as needed to bring the level to the upper mark on the dipstick.
26. Dispose of used filter and oil properly.

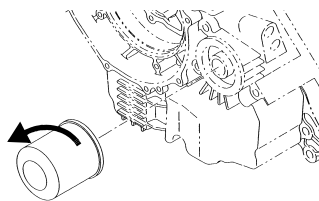

## Engine Oil Oil and Filter Change (500 EFI) Oil Pump Priming

This priming procedure must be performed whenever the oil hose connection between the oil tank and pump inlet has been disconnected.

1. Clamp or pinch off the vent line approximately 2" (5 cm) from the oil tank, between the end of the oil tank vent fitting and the vent line's pressure relief slit.
2. Start the engine. Allow it to idle for 10-20 seconds.
3. Remove the vent line clamp. If the line is bled properly, you should hear a rush of air, indicating that the line is properly primed and ready for operation.

**Tip:** If you do not hear air, the line has not bled. Repeat the priming procedure.

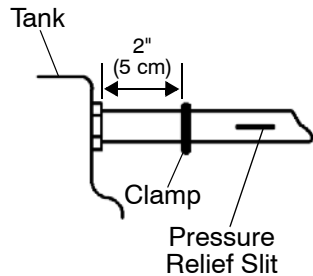



# MAINTENANCE

## Engine Oil

### Oil and Filter Change (800 EFI)

Always change the oil and filter at the intervals outlined in the Periodic Maintenance Chart beginning on page 75. Always change the oil filter whenever changing oil.

1. Position the vehicle on a level surface.
2. Start the engine. Allow it to warm up at idle for two to three minutes.
3. Stop the engine.
4. Clean the area around the drain plug.
5. Place a drain pan under the crankcase.
6. Remove the drain plug. Allow the oil to drain completely.

**CAUTION!** Hot oil can cause burns to skin. Do not allow hot oil to contact skin.

7. Install a new sealing washer on the drain plug. The sealing surfaces on drain plug and crankcase should be clean and free of burrs, nicks or scratches.
8. Reinstall the drain plug. Torque to 20 ft. lbs. (27 Nm).

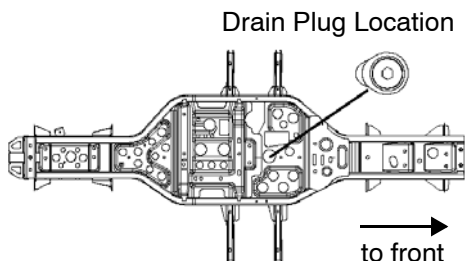

## Engine Oil Oil and Filter Change (800 EFI)

9. Place shop towels beneath the oil filter. Using an oil filter wrench (available from your Polaris dealer), turn the filter counterclockwise to remove it.
10. Using a clean dry cloth, clean the filter sealing surface on the crankcase.
11. Lubricate the o-ring on the new filter with a film of fresh engine oil. Check to make sure the o-ring is in good condition.
12. Install the new filter and rotate it clockwise by hand until the filter gasket contacts the sealing surface, then turn it an additional 1/2 turn.
13. Remove the dipstick.
14. Add two quarts (1.9 l) of recommended oil.
15. Place the transmission in **PARK**.
16. Lock the parking brake.
17. Start the engine. Allow it to idle for one to two minutes.
18. Stop the engine.
19. Check for leaks.
20. Check the oil level. Add oil as needed to bring the level to the upper mark on the dipstick.
21. Dispose of used filter and oil properly.

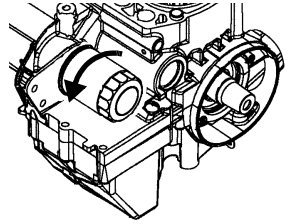

# MAINTENANCE

## Transmission Oil

Always check and change the transmission oil at the intervals outlined in the Periodic Maintenance Chart beginning on page 75. Maintain the oil level at the bottom of the fill plug hole threads. We recommend the use of Polaris Premium AGL Synthetic Gearcase Lubricant. See page 133 for the part numbers of Polaris products.

The fill plug is located on the left side of the ATV, under the rear fender, behind the wheel.

The drain plug is located on the right side of the gearcase, on the right side of the ATV, behind the wheel well.

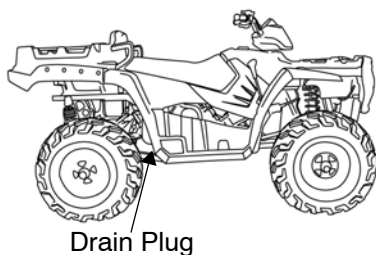
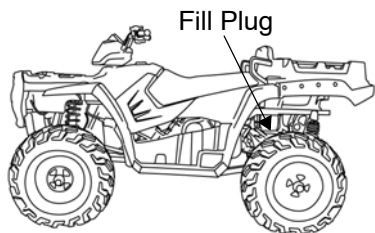

## Transmission Oil Level

1. Position the vehicle on a level surface.
2. Remove the fill plug.
3. Check the oil level. Add the recommended oil as needed.
4. Reinstall the fill plug. Torque to 20-25 ft. lbs. (27-34 Nm).

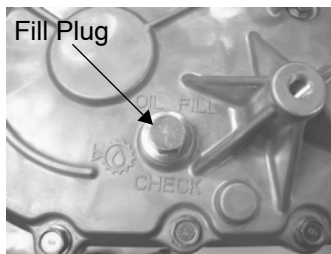

## Transmission Oil Transmission Oil Change

1. Remove the fill plug.
2. Place a drain pan under the gearcase.
3. Remove the drain plug. Allow the oil to drain completely.
4. Clean and reinstall the drain plug. Torque to 20-25 ft. lbs. (27-34 Nm).
5. Add 32 oz. (948 ml) of the recommended oil.
6. Reinstall the fill plug. Torque to 20-25 ft. lbs. (27-34 Nm).
7. Check for leaks. Dispose of used oil properly.

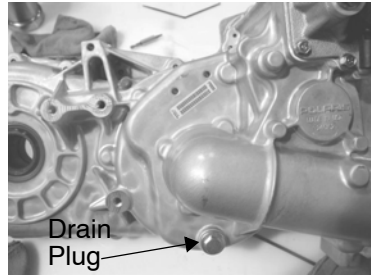

## Front Gearcase (Demand Drive) Fluid

Always check and change the demand drive fluid at the intervals outlined in the Periodic Maintenance Chart beginning on page 75. We recommend the use of Demand Drive LT Premium Fluid. Use of other fluids may result in improper operation of components. See page 133 for the part numbers of Polaris products.

Maintain the fluid level at the bottom of the fill hole threads. See below for capacity.

The fill plug is located on the right side of the demand drive unit. The drain plug is located on the bottom right side of the unit.

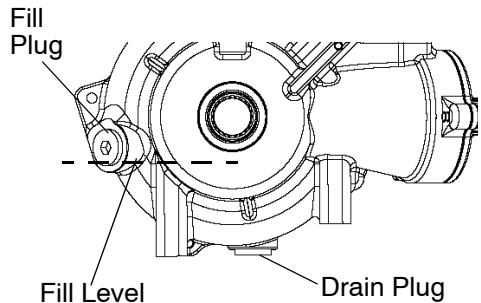

Demand Drive Capacities	
Demand Drive with ADC	9.3 oz. (275 ml)

# MAINTENANCE

## Front Gearcase (Demand Drive) Fluid

### Fluid Level

1. Position the vehicle on a level surface.
2. Remove the fill plug. Check the fluid level.
3. Add the recommended demand drive fluid as needed to bring the level to the bottom of the fill hole threads.
4. Reinstall the fill plug. Torque to 8-10 ft. lbs. (11-14 Nm).

### Fluid Change

1. Position the vehicle on a level surface.
2. Remove the fill plug.
3. Place a drain pan under the demand drive unit.
4. Remove the drain plug. Allow the fluid to drain completely.
5. Clean and reinstall the drain plug. Torque to 11 ft. lbs. (15 Nm).
6. Add the recommended fluid. See page 89 for capacity. Maintain the fluid level at the bottom of the fill hole threads.
7. Reinstall the fill plug. Torque to 8-10 ft. lbs. (11-14 Nm).
8. Check for leaks.
9. Dispose of used fluid properly.

## Active Descent Control (ADC) Fluid

Two fluid levels must be maintained on your vehicle, the demand drive fluid and the ADC fluid. See page 89 for demand drive fluid maintenance.

Check and change the ADC fluid level at the intervals outlined in the Periodic Maintenance Chart beginning on page 75. Maintain the fluid level between the minimum and maximum marks on the reservoir. We recommend the use of Polaris ADC Fluid. See page 133 for the part numbers of Polaris products.

**NOTICE:** Do not use brake fluid. Brake fluid will damage rubber components in the hydraulic system.

## Active Descent Control (ADC) Fluid

### Fluid Level

1. Open the front box cover and pull open the access door.
2. View the fluid level in the reservoir. If the level is below the minimum mark, remove the cap and add the recommended fluid.
3. Reinstall the cap securely. Secure the access door and box cover.

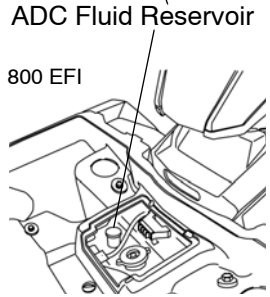
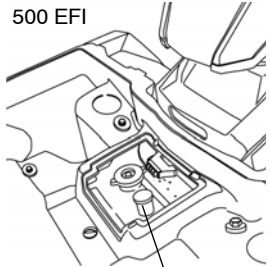

### Fluid Change

1. Position the vehicle on a level surface. Before performing the fluid change, allow the vehicle to sit for at least 30 minutes.
2. Thoroughly clean the areas around and on the ADC reservoir and bleeder valves (one on each side of the differential).
3. Remove the reservoir cap and diaphragm assembly. Use a shop towel or suction tool to remove debris from the fluid and reservoir. Debris in the reservoir may result in inadequate bleeding and reduced performance of the system.
4. Fill the reservoir to the maximum line with fresh ADC fluid.
5. Remove the protective caps from the bleeder valves.
6. Slowly loosen one of the valves (turn counter-clockwise) and allow fluid and trapped air to flow from the fitting. Close the valve when clean fluid begins to flow. Repeat this step for the remaining valve.

**IMPORTANT:** Close the bleeder valves before the reservoir fluid level drops below the minimum fill line. Adding fluid to an empty reservoir will result in trapped air. If the level drops below the minimum line, add fluid to the maximum line and repeat step 6 before proceeding.

7. Torque the valves to 80 in. lbs. (9 Nm). Reinstall the valve caps.
8. Add fresh ADC fluid to the reservoir until the level is between the minimum and maximum marks. Make sure the reservoir is free of debris.
9. Reinstall the cap securely. Clean up any drips or spills.

# MAINTENANCE

## Cooling System

The engine coolant level is controlled, or maintained, by the recovery system. The recovery system components are the recovery bottle, the radiator filler neck, the radiator pressure cap and the connecting hose.

As coolant operating temperature increases, the expanding (heated) excess coolant is forced out of the engine, past the pressure cap, and into the recovery bottle. As engine coolant temperature decreases the contracting (cooled) coolant is drawn back up from the bottle, past the pressure cap, and into the radiator.

Some coolant level drop on new vehicles is normal as the system is purging itself of trapped air. Check the coolant level and maintain as recommended by adding coolant to the recovery bottle.

Polaris recommends the use of Polaris Premium 60/40 anti-freeze/coolant or a 50/50 mixture of high quality aluminum compatible anti-freeze/coolant and distilled water. Polaris Premium 60/40 is already premixed and ready to use. Do not dilute with water. See page 133 for the part numbers of Polaris products.

Always follow the manufacturer's mixing recommendations for the freeze protection required in your area.

### Recovery Bottle Coolant

The recovery bottle is located on the left side of the vehicle.

1. Remove the left side panel. See page 96.
2. Maintain the coolant level between the minimum and maximum marks on the bottle (when the fluid is cool).
3. Add coolant as needed.

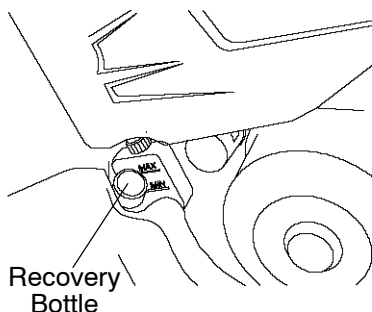

## Cooling System Radiator Coolant

To ensure that the coolant maintains its ability to protect the engine, Polaris recommends that you drain the system completely every two years and add a fresh mixture of antifreeze and water.

Replace the coolant any time the cooling system has been drained for maintenance or repair. If the recovery bottle has run dry, check the level in the radiator. Add coolant as needed.

**CAUTION!** Escaping steam can cause burns. Never remove the pressure cap while the engine is warm or hot. Always allow the engine to cool before removing the pressure cap.

1. Open the front box cover and pull open the access door.
2. Remove the pressure cap.
3. Using a funnel, slowly add coolant through the radiator filler neck.
4. Reinstall the pressure cap. Use of a non-standard pressure cap will not allow the recovery system to function properly. Contact your dealer for the correct replacement part.
5. Secure the access door.
6. Secure the box cover.

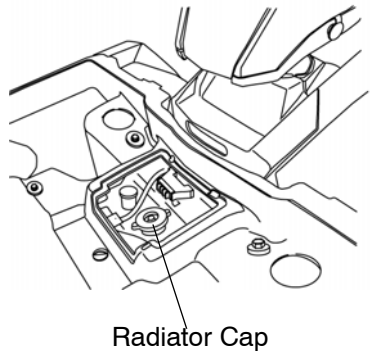



# MAINTENANCE

## Brakes

### Hand Brake

The front and rear brakes are hydraulic disc brakes, activated by moving the single brake lever toward the handlebar. These brakes are self-adjusting.

Under normal operation, the diaphragm extends into the reservoir as fluid level drops. If the fluid level is low and the diaphragm is not extended, a leak is likely and the diaphragm should be replaced. To ensure proper diaphragm operation, always fill the reservoir as needed whenever the cover is loosened or removed. Do not overfill.

**WARNING!** An over-full master cylinder may cause brake drag or brake lock-up, which could result in serious injury or death. Maintain brake fluid at the recommended level. Do not overfill.

The following checks are recommended to keep the brake system in good operating condition. Check more often if brakes are used heavily under normal operation.

1. Always keep brake fluid at an adequate level. See page 32.
2. Check the brake system for fluid leaks.
3. Check the brakes for excessive travel or spongy feel.
4. Check the friction pads for wear, damage and looseness. Replace brake pads when they are worn to  $3/64$ " (1 mm).
5. Check the security and surface condition of the disc.

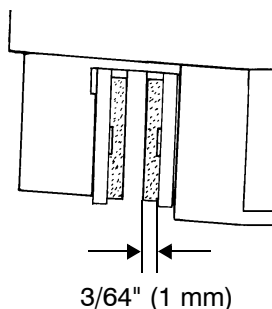

### Auxiliary Foot Brake

The hydraulic auxiliary brake system requires no adjustment. Check the brake fluid level frequently for the auxiliary brake system. See page 34.

## Toe Alignment

Use the following procedure to check the toe alignment of the vehicle. The recommended toe alignment is 1/8" to 1/4" (3-6 mm) toe out.

**WARNING!** Severe injury or death can result from improper toe alignment and adjustment. Do not attempt to adjust tie rod alignment. All tie rod adjustments should be performed by an authorized Polaris dealer.

1. Position the vehicle on a level surface.
2. Place the handlebars in a straight-ahead position.
3. Tie a length of string between two stands as shown in the illustration. Position the stands so that the string is flush with the side of the rear tire. If available, you may use a long straight-edge instead of string.
4. Measure the distance from the string to the rim at the front (1) and rear (2) of the front rim.

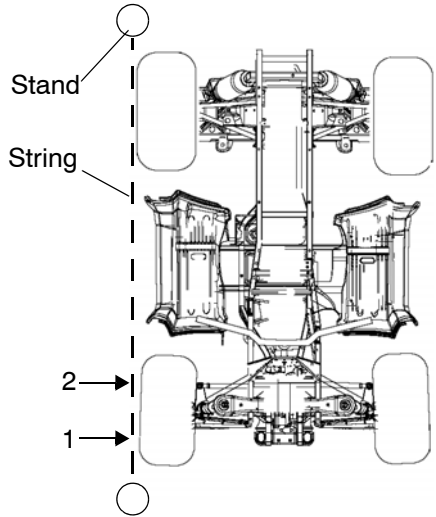

The rear measurement should be 1/16"-1/8" (2-3 mm) more than the front measurement on each side of the vehicle to obtain the recommended 1/8" to 1/4" (3-6 mm) toe out alignment.

5. Repeat the measurement procedure on the other side of the vehicle.
6. If you discover improper alignment, see your Polaris dealer for service.

# MAINTENANCE

## Steering Assembly

The steering assembly of the ATV should be checked periodically for loose nuts and bolts. If loose nuts and bolts are found, see your Polaris dealer for service before operating the vehicle.

## Side Panel Removal

1. Remove the seat.
2. Grasp the rear of the side panel near the rear cab. With a firm motion, pull the panel outward to disengage the side panel from the grommet. Pull the panel downward and rearward to remove it.
3. When reinstalling side panels, align the fasteners and press firmly to secure them.

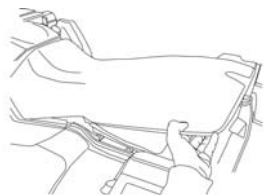

Step 1

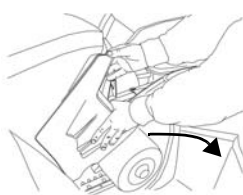

Step 2

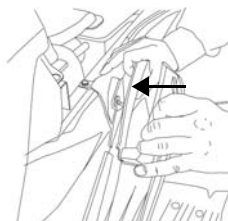

Step 3

## Footwell Removal

1. Remove the six screws on the bottom of the footwell.
2. Use a flat screwdriver or sidecutters to remove the plastic rivets securing the footwell to the fenders.
3. Remove the footwell.

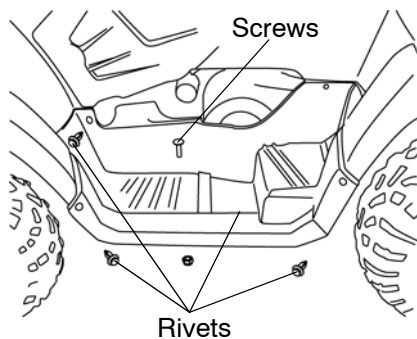

## Tires

### **⚠ WARNING**

Operating your ATV with worn tires, improperly inflated tires, non-standard tires or improperly installed tires will affect vehicle handling and could cause an accident resulting in serious injury or death. Always follow all tire maintenance procedures as outlined in this manual and on the labels on the vehicle. Always use original equipment size and type when replacing tires.

Refer to the specifications section beginning on page 134 for recommended tire type, size and pressure.

### Tire Tread Depth

Always replace tires when tread depth is worn to 1/8" (3 mm) or less.

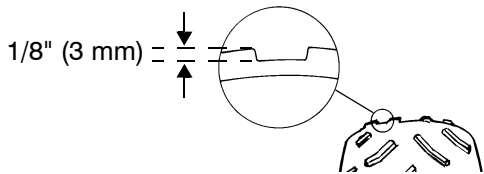

### Front Wheel Hub Tightening

Front wheel bearing tightness and spindle nut retention are critical component operations. All service must be performed by your authorized Polaris dealer.

### Wheel Removal

1. Stop the engine.
2. Place the transmission in PARK.
3. Lock the parking brake.
4. Loosen the wheel nuts slightly.

**WARNING!** Do not service axle nuts that have a cotter pin installed. See your Polaris dealer.

5. Elevate the side of the vehicle by placing a suitable stand under the footrest frame.
6. Remove the wheel nuts.
7. Remove the wheel.

# MAINTENANCE

## Tires

### Wheel Installation

1. Place the transmission in PARK.
2. Lock the parking brake.
3. Place the wheel on the hub with the valve stem toward the outside and rotation arrows on the tire pointing toward forward rotation.
4. Install the wheel nuts and finger-tighten them.
5. Lower the vehicle to the ground.
6. Torque the wheel nuts to specification.

**WARNING!** Loose nuts could cause a tire to come off during operation, which could result in an accident or overturn. Always ensure that all nuts are torqued to specification.

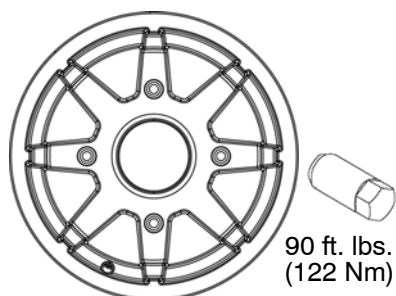

**Cast Aluminum**

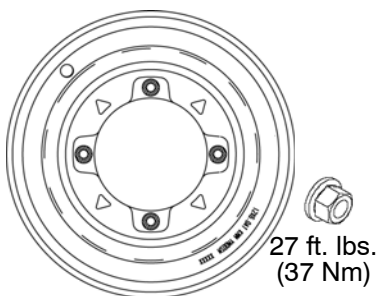

**Steel**

### Wheel Nut Torque Specifications

Check the wheel nut torques occasionally and when they've been loosened for service.

Nut Type	Nut Torque
Lug Nut	90 ft. lbs. (122 Nm)
2-Piece Flange Nut	27 ft. lbs. (37 Nm)

## Air Filter

1. Remove the seat.
2. Release the air box cover clips, and remove the air box cover.
3. Loosen the clamp and remove the filter.
4. Remove the fabric type pre-filter from the main filter. Wash the pre-filter in soapy water, then rinse and let dry.
5. Reinstall the pre-filter over the main filter. Install a new main filter if needed.
6. Reinstall the filter into the air box and tighten the clamp. Do not over-tighten the clamp, as filter damage could occur.
7. Reinstall the air box cover and the seat.

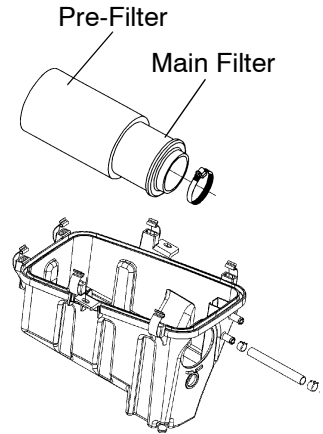

# MAINTENANCE

## Breather Filter/Hose (500 EFI)

The breather filter is on the hose that runs between the engine and air box.

1. Remove the left side panel. See page 96.
2. Remove the hose clamps from the filter and pull the filter out of the hoses.
3. Inspect the filter for debris. Blow gently through the filter in the direction of the arrow to check for clogging. Replace a damaged or clogged filter.
4. Check the hoses for cracks, deterioration, abrasion, or leaks. Replace as needed.
5. Reinstall the filter and hose clamps.

**Tip:** The filter is effective with the arrow pointing in either direction.

**NOTICE:** Operation of your vehicle without a breather filter can cause engine damage. Always reinstall the breather filter after removing it for service.

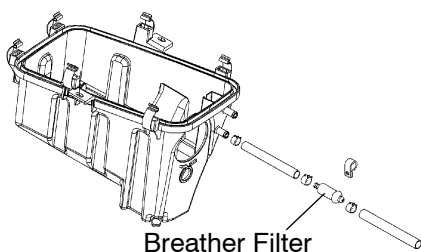

## Fuse Replacement

If the engine stops or will not start, or if you experience other electrical failures, a fuse may need replacement. Spare fuses are provided in a compartment on the top of the access door.

1. Open the front box cover and pull open the access door.
2. Remove the suspect fuse from the fuse panel. If the fuse is blown, install a new fuse with the same amperage.
3. Secure the access door.
4. Secure the box cover.

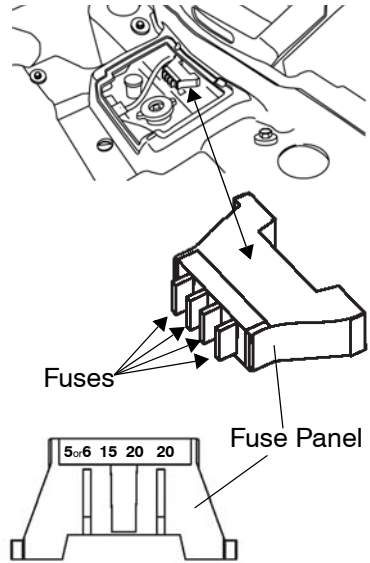



# MAINTENANCE

## Lights

Poor lighting can result in reduced visibility when driving. Headlight and taillight lenses become dirty during normal operation. Clean headlights frequently and replace burned out headlamps promptly. Always make sure lights are adjusted properly for best visibility.

### Headlight Lamp Replacement

When servicing a halogen lamp, avoid touching the lamp with bare fingers. Oil from your skin leaves a residue, causing a hot spot that will shorten the life of the lamp. If fingers do touch a lamp, clean it with denatured alcohol.

1. Remove the two screws on the lower front corners of the headlight pod.
2. Remove the screw from the rear of the pod.
3. Lift the pod slightly while depressing the tabs at the rear of the pod.
4. Lift the pod cover and disconnect the speedometer harnesses from the speedometer.

**CAUTION!** Hot components can cause burns to skin. Allow lamps to cool before servicing.

5. Unplug the headlamp from the wiring harness. Be sure to pull on the connector, not on the wiring.
6. Turn the lamp counterclockwise to remove it.
7. Apply dielectric grease to the socket and install the new lamp. Make sure the tab on the lamp locates properly in the housing.
8. Reassemble the pod.

## Lights

### High Beam Adjustment

The headlight beam can be adjusted slightly upward or downward. Use the following procedure to make the adjustment.

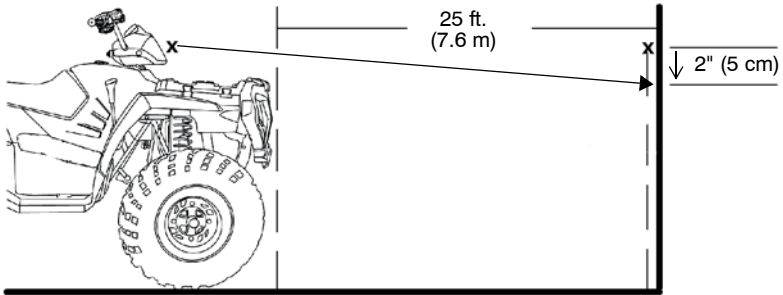

1. Position the vehicle on a level surface with the headlight approximately 25 ft. (7.6 m) from a wall. Place the transmission in PARK.
2. Measure the distance from the floor to the center of the headlight and make a mark on the wall at the same height.
3. Start the engine. Turn the headlight switch to high beam.
4. Observe the headlight aim on the wall. The most intense part of the headlight beam should be two inches (5 cm) below the mark on the wall. Include rider weight on the seat when measuring.
5. The adjustment knob is located on the right side of the headlight pod. Adjust the beam to the desired position by turning the knob either clockwise or counterclockwise.

### Low Beam Adjustment

The low beam can be adjusted slightly upward or downward.

1. Loosen the phillips screw located at the rear of the headlamp.
2. Tilt the headlamp upward or downward.
3. Tighten the screw.

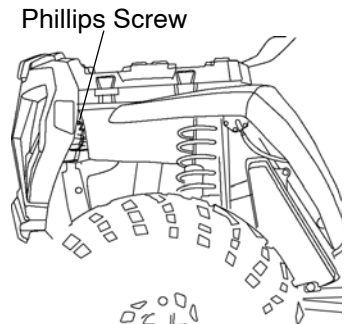

# MAINTENANCE

## Lights

### Headlight Housing Replacement

1. Remove the two screws on the lower front corners of the headlight pod.
2. Lift the pod slightly while depressing the tabs at the rear of the pod.
3. Lift the pod cover and disconnect the speedometer harnesses from the speedometer.
4. Unplug the headlamp from the wiring harness.
5. Use a small screwdriver to remove the o-rings from the headlight mounting tabs.
6. Pull the headlight housing up to release it from the locking tabs.
7. Lift the adjusting knob up to remove it from the locking tabs.
8. Carefully pull the assembly up and out of the pod.
9. Reverse the steps to install the new housing and reassemble the pod. The distance from the headlamp parting line to the end of the adjustment knob stop is  $5 \frac{1}{8}$ " (13 cm).
10. Adjust the headlight aim by turning the adjusting knob.

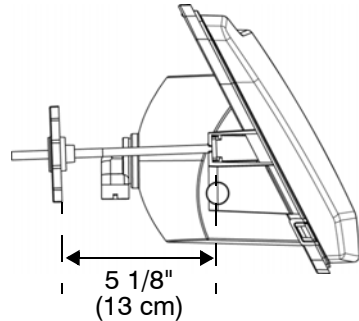

## Lights

### Lower Headlamp Replacement

1. Turn the back of the headlight harness counterclockwise and pull the harness assembly away from the headlight assembly.
2. Remove the headlamp and install the new headlamp.
3. Reinstall the harness assembly into the headlight assembly.
4. Turn the headlight harness clockwise to secure the headlamp.

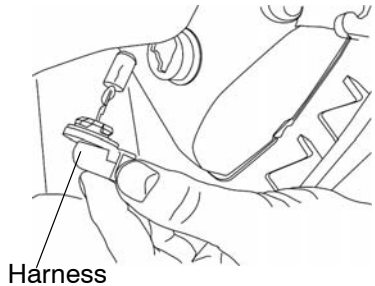

### Taillight/Brakelight/Worklight (if equipped) Lamp Replacement

1. Open the tailgate.
2. Remove the two screws near the tailgate latch.
3. Grasp the entire taillight assembly and pull it away from the vehicle.
4. Remove the harness connector from the back of the light assembly.
5. Turn the lamp counterclockwise to remove it.
6. Apply dielectric grease to the socket and install the new lamp.
7. Reinstall the harness connector.
8. Test the light for proper operation.
9. Reinstall the taillight assembly.
10. Reinstall the two screws.

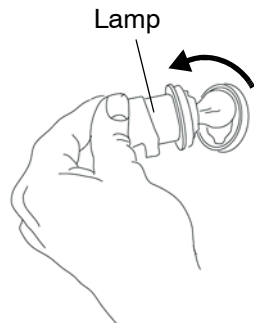
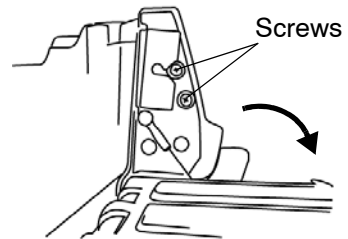

# MAINTENANCE

## Spark Plugs

### Spark Plug Recommendations

Refer to the specifications section beginning on page 134 for the recommended spark plug type and gap for your vehicle. Torque spark plugs to specification.

**NOTICE:** Using non-recommended spark plugs can result in serious engine damage. Always use Polaris-recommended spark plugs.

Plug Condition	Torque Specification
New Spark Plug	9-11 ft. lbs. (12-15 Nm)
Previously Installed Spark Plug	17-20 ft. lbs. (23-27 Nm)

### Spark Plug Inspection

Spark plug condition is indicative of engine operation. Check the spark plug firing end condition after the engine has been warmed up and the vehicle has been driven at higher speeds. Immediately check the spark plug for correct color. See page 107.

**CAUTION!** A hot exhaust system and engine can cause burns. Wear protective gloves when removing a spark plug for inspection.

1. Rotate the spark plug cap 1/4 turn and pull it off the spark plug.
2. Using the special wrench provided in the tool pouch, rotate the spark plug counterclockwise to remove it.
3. Reverse the procedure for spark plug installation. Torque to specification.

## **Spark Plugs**

### **Spark Plug Inspection**

#### **Normal Spark Plug**

The normal insulator tip is gray, tan or light brown. There will be few combustion deposits. The electrodes are not burned or eroded. This indicates the proper type and heat range for the engine and the service.

The tip should not be flaky and white. A white insulator tip indicates overheating, caused by use of an improper spark plug or incorrect fuel.

#### **Wet Fouled Spark Plug**

The wet fouled insulator tip is black. A damp oil film covers the firing end. There may be a carbon layer over the entire nose. Generally, the electrodes are not worn. General causes of fouling are excessive oil, use of non-recommended oil or incorrect throttle body adjustments.

# MAINTENANCE

## Vehicle Immersion

If your vehicle becomes immersed, major engine damage can result if the machine is not thoroughly inspected. Take the vehicle to your dealer before starting the engine. If it's impossible to take your ATV to a dealer before starting it, follow the steps outlined below.

1. Move the ATV to dry land or at the very least, to water below the footrests.
2. Check the air box. If water is present, dry the air box and replace the filter with a new filter.
3. Remove the spark plug.
4. Turn the engine over several times using the electric start.
5. Dry the spark plug. Reinstall the plug or install a new plug.
6. Attempt to start the engine. If necessary, repeat the drying procedure.
7. Take the ATV to your dealer for service as soon as possible, whether you succeed in starting it or not.
8. If water has been ingested into the PVT, follow the procedure on page 112 for drying out the PVT.

## Spark Arrestor

### **⚠ WARNING**

Failure to heed the following warnings while servicing the spark arrestor could result in serious injury or death. Never run the engine in an enclosed area. Remove any combustible materials from the area. Wear eye protection and leather work gloves. Do not stand behind or in front of the vehicle while purging. Never go under the vehicle while it's inclined.

The exhaust system can get extremely hot. Do not perform service on the spark arrestor while the system is hot. Allow components to cool sufficiently before proceeding.

Use the following procedure to periodically purge accumulated carbon from the exhaust pipe/muffler.

1. Remove the arrestor clean-out plug from the bottom of the muffler.
2. Place the transmission in **PARK**.
3. Start the engine.
4. Quickly squeeze and release the throttle lever several times to purge carbon from the system.
5. If carbon comes out of the exhaust, cover or plug the exhaust outlet. Wear protective gloves.
6. Lightly tap on the exhaust pipe with a rubber mallet while repeating step 4.
7. If particles are still suspected to be in the muffler, elevate the rear of the vehicle one foot (30 cm) higher than the front. Block the wheels.
8. Place the transmission in **PARK**. Lock the parking brake. Repeat steps 4 to 6 until no more particles are expelled.
9. Stop the engine. Allow the arrestor to cool.
10. Reinstall the arrestor plug and remove the exhaust outlet cover or plug.

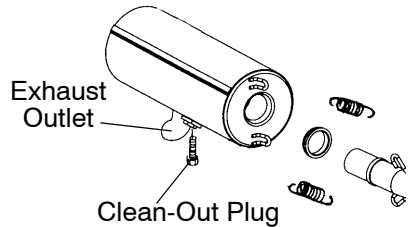



# MAINTENANCE

## PVT System

### WARNING

Failure to comply with the instructions in this warning can result in severe injury or death.

Do not modify any component of the PVT system. Doing so may reduce its strength so that a failure may occur at a high speed. The PVT system has been precision balanced. Any modification will cause the system to be out of balance, creating vibration and additional loads on components.

The PVT system rotates at high speeds, creating large amounts of force on clutch components. Extensive engineering and testing has been conducted to ensure the safety of this product. However, as the owner, you have the following responsibilities to make sure this system remains safe:

- Always follow all recommended maintenance procedures. See your dealer as outlined in the owner's manual.
- This PVT system is intended for use on Polaris products only. Do not install it in any other product.
- Always make sure the PVT housing is securely in place during operation.

## PVT System

The basic operation of the Polaris PVT system is dependent on engine speed and vehicle torque requirements. As engine speed increases, the force exerted on the movable drive sheave by the flyweights also increases. This, in turn, increases the amount of pinch applied to the drive belt. Similarly, if the engine speed decreases, the amount of centrifugal force decreases, reducing the amount of belt pinch.

On Polaris ATVs, the approximate gear ratio difference between high and low range is 1:2.25. This difference in gearing affects the operation of the PVT, especially at speeds less than 7 MPH (11 km/h), due to the system's dependence on engine speed.

For example, when operating at a ground speed of 3 MPH (5 km/h) in low range, the engine speed would be around 3000 RPM. This is well above the engagement speed of 1200 - 1400 RPM. However, in high range at 3 MPH (5 km/h), the engine would be running at only 1500 RPM. Whenever operating this close to the engagement speed, the engine may be running at a speed too low to provide the pinch needed to prevent belt slip. Belt slip is responsible for creating the excessive heat that destroys belts, wears clutch components and causes outer clutch covers to fail.

The air temperature in the clutch cover is substantially reduced by using low range while operating at low ground speeds. Reducing the temperature inside the clutch cover greatly extends the life of the PVT components (belt, cover, etc.).

# MAINTENANCE

## PVT System

### When To Use Low Range and High Range

Condition	Range to Use
Operating at speeds less than 7 MPH (11 km/h)	Low
Towing heavy loads	Low
Operating in rough terrain (swamps, mountains, etc.)	Low
Operating at speeds greater than 7 MPH (11 km/h)	High

### PVT Drying

There may be some instances when water is accidentally ingested into the PVT system. Use the following instructions to dry it out before operating.

1. Position the vehicle on a level surface.
2. Remove the drain plug. Allow the water to drain completely. Reinstall the drain plug.
3. Start the engine. Place the transmission in PARK.
4. Apply varying throttle for 10-15 seconds to expel the moisture and air-dry the belt and clutches. Do not hold the throttle wide open for more than 10 seconds.
5. Allow the engine RPM to settle to idle speed, then shift the transmission to the lowest available range.
6. Test for belt slippage. If the belt slips, repeat the process.
7. Take the vehicle to your dealer for service as soon as possible.

## Battery

### **⚠ WARNING**

Improperly connecting or disconnecting battery cables can result in an explosion and cause serious injury or death. When removing the battery, always disconnect the negative (black) cable first. When reinstalling the battery, always connect the negative (black) cable last.

### **⚠ WARNING**

Battery electrolyte is poisonous. It contains sulfuric acid. Serious burns can result from contact with skin, eyes or clothing.

Antidote:

**External:** Flush with water.

**Internal:** Drink large quantities of water or milk. Follow with milk of magnesia, beaten egg, or vegetable oil. Call physician immediately.

**Eyes:** Flush with water for 15 minutes and get prompt medical attention.

Batteries produce explosive gases. Keep sparks, flame, cigarettes, etc. away. Ventilate when charging or using in an enclosed space. Always shield eyes when working near batteries. **KEEP OUT OF REACH OF CHILDREN.**

Your ATV may have either a sealed battery, which requires little maintenance, or a conventional battery. A sealed battery can be identified by its flat covers on the top of the battery. A conventional battery has six filler caps on the top of the battery.

Always keep battery terminals and connections free of corrosion. If cleaning is necessary, remove corrosion with a stiff wire brush. Wash with a solution of one tablespoon baking soda and one cup water. Rinse well with tap water and dry off with clean shop towels. Coat the terminals with dielectric grease or petroleum jelly. Be careful not to allow cleaning solution or tap water into a conventional battery.

# MAINTENANCE

## Battery

### Battery Removal

1. Loosen the battery hold-down bolt.
2. Remove the battery cover.
3. On conventional batteries, remove the battery vent tube.
4. Disconnect the black (negative) battery cable first.
5. Disconnect the red (positive) battery cable last.
6. Lift the battery out of the ATV. Be careful not to tip a conventional battery sideways, which could spill electrolyte.

**NOTICE:** If electrolyte spills, immediately wash it off with a solution of one tablespoon baking soda and one cup water to prevent damage to the vehicle.

## Battery

### Battery Installation

Using a new battery that has not been fully charged can damage the battery and result in a shorter life. It can also hinder vehicle performance. Follow the battery charging instructions on page 117 before installing the battery.

1. Ensure that the battery is fully charged.
2. Place the battery in the battery holder.
3. With conventional batteries, install the battery vent tube (sealed batteries do not have a vent tube). The vent tube must be free of obstructions and securely installed. Route the tube away from the frame and vehicle body to prevent contact with electrolyte.

**WARNING!** Battery gases could accumulate in an improperly installed vent tube and cause an explosion, resulting in serious injury or death. Always ensure that the vent tube is free of obstructions and is securely installed as recommended.

4. On conventional batteries, coat the terminals with dielectric grease or petroleum jelly.
5. Connect and tighten the red (positive) cable first.
6. Connect and tighten the black (negative) cable last.
7. Install the battery cover.
8. Tighten the battery hold-down bolt.
9. Verify that cables are properly routed. Cables should be safely tucked away at the front and rear of the battery.

# MAINTENANCE

## Battery

### Battery Storage

Whenever the vehicle is not used for a period of three months or more, remove the battery from the vehicle, ensure that it's fully charged, and store it out of the sun in a cool, dry place. Check battery voltage each month during storage and recharge as needed to maintain a full charge.

**Tip:** Power plug leads may need to be bent down so that the battery cover can be installed.

Polaris recommends maintaining battery charge by using a Polaris Battery Tender charger or by charging about once a month to make up for normal self-discharge. Battery Tender can be left connected during the storage period, and will automatically charge the battery if the voltage drops below a pre-determined point. See page 133 for the part numbers of Polaris products.

### Battery Fluid (Conventional Battery)

A poorly maintained battery will deteriorate rapidly. Check the battery fluid level often. Maintain the fluid level between the upper and lower level marks.

Add only distilled water. Tap water contains minerals that are harmful to a battery.

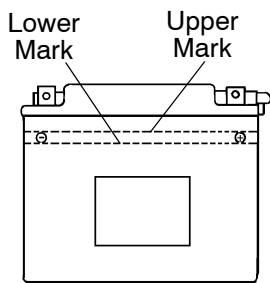

## Battery

### Battery Charging (Conventional Battery)

1. Remove the battery from the vehicle to prevent damage from leaking or spilled electrolyte during charging. See page 114.
2. Charge the battery with a charging output no larger than 1/10 of the battery's amp/hr rating. Charge as needed to raise the specific gravity to 1.270 or greater.
3. Reinstall the battery. See page 115. Make sure the positive terminal is toward the front of the vehicle.

### Battery Charging (Sealed Battery)

The following battery charging instructions apply only to the installation of a sealed battery. Read all instructions before proceeding with the installation of this battery.

The sealed battery is already filled with electrolyte and has been sealed and *fully charged* at the factory. *Never* pry the sealing strip off or add any other fluid to this battery.

The single most important thing about maintaining a sealed battery is to keep it fully charged. Since the battery is sealed and the sealing strip cannot be removed, you must use a voltmeter or multimeter to measure DC voltage.

**WARNING!** An overheated battery may explode, causing severe injury or death. Always watch charging times carefully. Stop charging if the battery becomes very warm to the touch. Allow it to cool before resuming charging.

For a refresh charge, follow all instructions carefully.

1. Check the battery voltage with a voltmeter or multimeter. A fully charged battery will register 12.8 V or higher.
2. If the voltage is less than 12.8 volts, recharge the battery at 1.2 amps or less until battery voltage is 12.8 or greater.
3. When using an automatic charger, refer to the charger manufacturer's instructions for recharging. When using a constant current charger, use the guidelines on the next page for recharging.



# MAINTENANCE

## Battery

### Battery Charging (Sealed Battery)

Always verify battery condition before and 1-2 hours after the end of charging.

<b>State of Charge</b>	<b>Voltage</b>	<b>Action</b>	<b>Charge Time</b> (Using constant current charger @ standard amps specified on top of battery)
100%	12.8-13.0 volts	None, check at 3 mos. from date of manufacture	None required
75%-100%	12.5-12.8 volts	May need slight charge, if no charge given, check in 3 months	3-6 hours
50%-75%	12.0-12.5 volts	Needs charge	5-11 hours
25%-50%	11.5-12.0 volts	Needs charge	At least 13 hours, verify state of charge
0%-25%	11.5 volts or less	Needs charge with desulfating charger	At least 20 hours

## Cleaning and Storage

### Washing the Vehicle

Keeping your Polaris vehicle clean will not only improve its appearance but it can also extend the life of various components.

**NOTICE:** High water pressure may damage components. Polaris recommends washing the vehicle by hand or with a garden hose, using mild soap.

Certain products, including insect repellents and chemicals, will damage plastic surfaces. Do not allow these types of products to contact the vehicle.

The best and safest way to clean your Polaris vehicle is with a garden hose and a pail of mild soap and water.

1. Use a professional-type washing cloth, cleaning the upper body first and the lower parts last.
2. Rinse with clean water frequently.
3. Dry surfaces with a chamois to prevent water spots.

### Washing Tips

- Avoid the use of harsh cleaners, which can scratch the finish.
- Do not use a power washer to clean the vehicle.
- Do not use medium to heavy duty compounds on the finish.
- Always use clean cloths and pads for cleaning and polishing. Old or reused cloths and pads may contain dirt particles that will scratch the finish.

# MAINTENANCE

## Cleaning and Storage

### Washing the Vehicle

If a high pressure water system is used for cleaning (not recommended), exercise extreme caution. The water may damage components and could remove paint and labels. Avoid directing the water stream at the following items:

- Wheel bearings
- Radiator
- Transmission seals
- Brakes
- Cab and body panels
- Labels and decals
- Electrical components and wiring

If warning and safety labels are damaged, contact your Polaris dealer for free replacement.

Grease all zerk fittings immediately after washing. Allow the engine to run for a while to evaporate any water that may have entered the engine or exhaust system.

### Polishing the Vehicle

Polaris recommends the use of common household aerosol furniture polish for polishing the finish on your Polaris vehicle. Follow the instructions on the container.

#### Polishing Tips

- Avoid the use of automotive products, some of which can scratch the finish of your vehicle.
- Always use clean cloths and pads for cleaning and polishing. Old or reused cloths and pads may contain dirt particles that will scratch the finish.

## Cleaning and Storage

### Chrome Wheel Care (if equipped)

Proper maintenance will protect chrome wheels from corrosion, preserve wheel life and ensure a "like new" appearance for many years. Chrome wheels exposed to road salt (or salt in the air in coastal areas) are more susceptible to corrosion if not properly cleaned. Clean chrome wheels more often if they're exposed to salt or other corrosive elements.

1. Wash chrome wheels frequently. Use a mild detergent. Never use abrasive cleaners on plated or painted surfaces.
2. Rinse well with clear water. Soap, detergents, salt, dirt, mud and other elements can cause corrosion.
3. Polish the clean chrome wheels periodically. Use an automotive grade chrome polish.
4. Routinely and liberally apply a weather resistant wax to each polished chrome wheel. Choose a product suitable for chrome finishes. Read and follow the product labels and instructions.

### Removing Corrosion

If light rust is found on the chrome finish, use steel wool (#0000-OTT grade) to remove it. Gently rub the affected areas with the steel wool until the corrosion has been removed. Clean and polish the wheel as outlined above.

# MAINTENANCE

## Cleaning and Storage

### Storage Tips

**NOTICE:** Starting the engine during the storage period will disturb the protective film created by fogging and damage could occur. Never start the engine during the storage period.

### Clean the Exterior

Make any necessary repairs and clean the vehicle as recommended. See page 119.

### Stabilize the Fuel

1. Fill the fuel tank.
2. Add Polaris Carbon Clean Fuel Treatment or Polaris Fuel Stabilizer. Follow the instructions on the container for the recommended amount. Carbon Clean removes water from fuel systems, stabilizes fuel and removes carbon deposits from pistons, rings, valves and exhaust systems.
3. Allow the engine to run for 15-20 minutes to allow the stabilizer to disperse through the entire fuel delivery system.

### Oil and Filter

Change the oil and filter. See page 83.

### Air Filter / Air Box

1. Inspect and clean (or replace) the pre-cleaner and air filter. See page 99.
2. Clean the air box.
3. Drain the sediment tube.
4. Clean or replace the breather filter (if equipped). See page 100.

## Cleaning and Storage

### Storage Tips

#### Fluid Levels

Inspect the fluid levels. Add or change fluids as recommended in the Periodic Maintenance Chart beginning on page 75.

- Demand drive unit (front gearcase)
- ADC fluid (ADC models) (change every two years)
- Rear gearcase (if equipped)
- Transmission
- Brake fluid (change every two years and any time the fluid looks dark or contaminated)
- Coolant (test strength/fill)

#### Fog the Engine

1. Treat the fuel system with Polaris Carbon Clean. Follow the instructions on the container. Start the engine. Allow it to idle for several minutes so the Carbon Clean reaches the injectors. Stop the engine.
2. Remove the spark plug and add 2-3 tablespoons of engine oil. To access the plug hole, use a section of clear 1/4" hose and a small plastic squeeze bottle filled with the pre-measured amount of oil. *Do this carefully.* If you miss the plug hole, oil will drain from the spark plug cavity into the hole at the front of the cylinder head, and appear to be an oil leak.
3. Reinstall the spark plug. Torque to specification.
4. Apply dielectric grease to the inside of each spark plug cap and reinstall the caps onto the plugs.
5. Turn the engine over several times. Oil will be forced in and around the piston rings and ring lands, coating the cylinder with a protective film of fresh oil.
6. If Polaris fuel system additive is not used, the fuel tank, fuel lines, and injectors should be completely drained of gasoline.

# **MAINTENANCE**

## **Cleaning and Storage**

### **Storage Tips**

#### **Inspect and Lubricate**

Inspect all cables and lubricate all areas of the vehicle as recommended in the Periodic Maintenance Chart beginning on page 75.

#### **Battery Storage**

See pages 116-117 for storage and charging procedures.

#### **Storage Area/Covers**

Set the tire pressure and safely support the ATV with the tires slightly off the ground. Be sure the storage area is well ventilated. Cover the vehicle with a genuine Polaris cover. Do not use plastic or coated materials. They do not allow enough ventilation to prevent condensation, and may promote corrosion and oxidation.

### **Accessories**

Auxiliary power outlets provide 12-volt power for operating accessories. Accessory outlets are available for all models. Polaris also has a wide range of additional accessories available for your ATV. Always install accessories that are approved for ATV use. Please see your Polaris dealer.

## Transporting the ATV

Follow these procedures when transporting the vehicle.

1. Stop the engine.
2. Place the transmission in **PARK**.
3. Lock the parking brake.
4. Always secure the seat in the 1-up position to prevent loss during transporting.
5. Secure the fuel cap and oil cap.
6. Always tie the frame of the ATV to the transporting unit securely with suitable straps or rope. Do not attach tie straps to the front A-arm bolt pockets.
7. Remove the key to prevent loss during transporting.

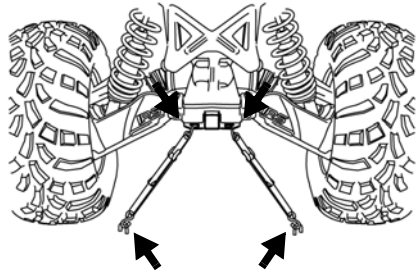
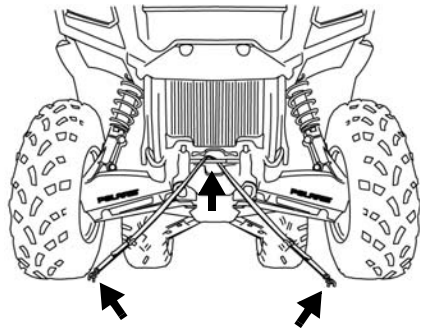



# ADJUSTMENTS

## Camber and Caster

The camber and caster are non-adjustable.

## Rear Spring

The rear shock absorber spring is adjusted by rotating the adjuster either clockwise or counterclockwise to increase or decrease spring tension.

**Tip:** Accessory springs are available through your Polaris dealer.

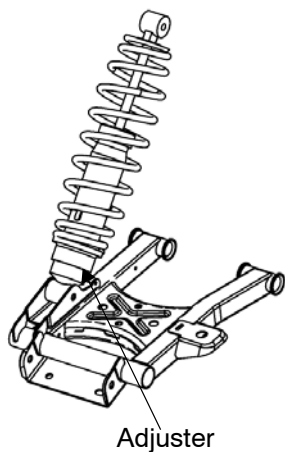

## Handlebars

The handlebars can be adjusted for rider preference.

**WARNING!** Improper adjustment of the handlebars or incorrect torquing of the adjuster block tightening bolts can cause limited steering or loosening of the handlebars, resulting in loss of control and serious injury or death. Follow the adjustment procedures exactly, or see your Polaris dealer for service.

1. Remove the upper headlight pod.
2. Loosen the four handlebar bolts.
3. Adjust the handlebar to the desired height. Be sure the handlebars do not contact the gas tank or any other part of the machine when turned fully to the left or right.
4. Torque the front two bolts to 10-12 ft. lbs. (14-17 Nm), then torque the rear two bolts. A gap of up to 1/8" (3 mm) will remain at the rear of the clamp blocks.

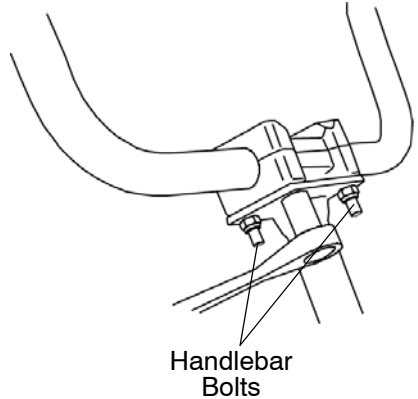

# ADJUSTMENTS

## Throttle Body/Idle RPM

Idle RPM is preset by the manufacturer. If the engine idle speed is not satisfactory, please see your Polaris dealer for adjustment.

## Throttle Cable Freeplay

Adjust throttle cable freeplay at the handlebar.

1. Locate the throttle cable adjuster at the handlebar.
2. Squeeze the end of the rubber boot and slide it far enough to expose the end of the inline cable adjuster.
3. Loosen the adjuster lock nut.
4. Rotate the boot to turn the adjuster until  $1/16''$  to  $1/8''$  (1.5-3 mm) of freeplay is achieved at the thumb lever. While adjusting freeplay, be sure to flip the throttle lever back and forth.
5. Tighten the lock nut.
6. Squeeze the end of the rubber boot and slide it over the cable adjuster to its original position.

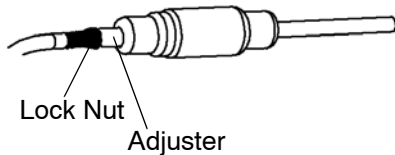
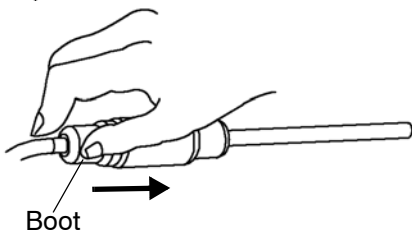
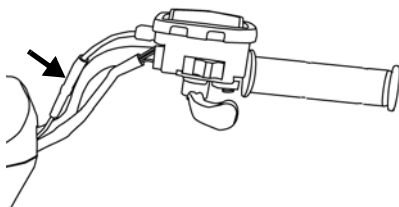

# TROUBLESHOOTING

## Drive Belt Wear/Burn

Possible Cause	Solution
Driving onto a pickup or tall trailer in high range	Use low range during loading.
Starting out going up a steep incline	Use low range or turn around using the K-turn (see page 64).
Driving at low RPM or ground speed (3-7 MPH)	Drive at a higher speed or use low range more frequently. See page 112.
Insufficient warm-up at low ambient temperatures	Warm the engine at least 5 minutes. With the transmission in neutral, advance the throttle to about 1/8 throttle in short bursts, 5 to 7 times. The belt will become more flexible and prevent belt burning.
Slow/easy clutch engagement	Use the throttle quickly and effectively.
Towing/pushing at low RPM/low ground speed	Use low range only.
Utility use/plowing	Use low range only.
Stuck in mud or snow	Shift the transmission to low range and carefully use fast, aggressive throttle application to engage clutch. <b>WARNING!</b> Excessive throttle may cause loss of control and vehicle overturn.
Climbing over large objects from a stopped position	Shift the transmission to low range and carefully use fast, brief, aggressive throttle application to engage clutch. <b>WARNING!</b> Excessive throttle may cause loss of control and vehicle overturn.
Belt slippage from water or snow ingestion into the PVT system	Dry out the PVT. See page 112. Inspect clutch seals for damage if repeated leaking occurs.
Clutch malfunction	See your Polaris dealer.
Poor engine performance	Check for fouled plugs or foreign material in gas tank or fuel lines. See your dealer.
Slippage from failure to warm up belt	Always warm up the belt by operating below 30 mph for one mile (5 miles or more when temperature is below freezing).
Wrong or missing belt	Install the recommended belt.
Improper break-in	Always break in a new belt and/or clutch. See page 51.

# TROUBLESHOOTING

## Engine Doesn't Turn Over

Possible Cause	Solution
Low battery voltage	Recharge the battery to 12.8 VDC
Loose battery connections	Check all connections and tighten
Loose solenoid connections	Check all connections and tighten

## Engine Turns Over, Fails to Start

Possible Cause	Solution
Out of fuel	Refuel, cycle key to ON position three times for 5 seconds each, then start
Clogged fuel filter	Replace the filter
Water is present in fuel	Drain the fuel system and refuel
Old or non-recommended fuel	Replace with fresh recommended fuel
Fouled or defective spark plug(s)	Inspect plugs and replace if necessary
No spark to spark plug	Inspect plugs, verify stop switch is on
Water or fuel in crankcase	Immediately see your Polaris dealer
Low battery voltage	Recharge the battery to 12.8 VDC
Mechanical failure	See your dealer

## Engine Backfires

Possible Cause	Solution
Weak spark from spark plug	Inspect, clean and/or replace spark plug(s)
Incorrect spark plug gap or heat range	Set gap to specs or replace plugs
Old or non-recommended fuel	Replace with fresh recommended fuel
Incorrectly installed spark plug wires	See your dealer
Incorrect ignition timing	See your dealer
Mechanical failure	See your dealer
Loose ignition connections	Check all connections and tighten
Water present in fuel	Replace with fresh recommended fuel

# TROUBLESHOOTING

## Engine Pings or Knocks

Possible Cause	Solution
Poor quality or low octane fuel	Replace with recommended fuel
Incorrect ignition timing	See your dealer
Incorrect spark plug gap or heat range	Set gap to specs or replace plugs

## Engine Runs Irregularly, Stalls or Misfires

Possible Cause	Solution
Fouled or defective spark plug(s)	Inspect, clean and/or replace spark plug(s)
Worn or defective spark plug wires	See your dealer
Incorrect spark plug gap or heat range	Set gap to specs or replace plugs
Loose ignition connections	Check all connections and tighten
Water present in fuel	Replace with new fuel
Low battery voltage	Recharge battery to 12.8 VDC
Kinked or plugged fuel tank vent line	Inspect and replace
Incorrect fuel	Replace with recommended fuel
Clogged air filter	Inspect and clean or replace
Reverse speed limiter malfunction	See your dealer
Electronic throttle control malfunction	See your dealer
Other mechanical failure	See your dealer

Possible Lean Fuel Cause	Solution
Low or contaminated fuel	Add or change fuel, clean the fuel system
Kinked or plugged fuel tank vent line	Inspect and replace
Low octane fuel	Replace with recommended fuel
Clogged fuel filter	Replace filter
Incorrect fuel	Replace with recommended fuel

Possible Rich Fuel Cause	Solution
Fuel is very high octane	Replace with lower octane fuel
Stopping/starting without adequate warm-up	Allow engine to warm up before operating and/or stopping
Incorrect fuel	Replace with recommended fuel
Clogged air filter	Inspect and clean or replace

# TROUBLESHOOTING

## Engine Stops or Loses Power

Possible Cause	Solution
Out of fuel	Refuel, cycle key to ON position three times for 5 seconds each, then start
Kinked or plugged fuel vent line	Inspect and replace
Water is present in fuel	Replace with new fuel
Fouled or defective spark plug(s)	Inspect, clean and/or replace spark plug(s)
Worn or defective spark plug wires	See your dealer
Incorrect spark plug gap or heat range	Set gap to specs or replace plug
Loose ignition connections	Check all connections and tighten
Low battery voltage	Recharge the battery to 12.8 VDC
Incorrect fuel	Replace with fresh recommended fuel
Clogged air filter	Inspect and clean or replace
Reverse speed limiter malfunction	See your dealer
Electronic throttle control malfunction	See your dealer
Other mechanical failure	See your dealer
Overheated engine	Clean radiator screen and core, clean engine exterior, see your dealer

## Engine Overheating

Possible Cause	Solution
Debris lodged in screen	Remove and clean the screen. Pull on the top portion of the screen, then remove the lower portion.
Plugged Radiator	Use a garden hose to flush any debris from the radiator fins. NOTE: High pressure washers can deform the radiator fins and reduce cooling efficiency.

# POLARIS PRODUCTS

<b>Part Number</b>	<b>Description</b>
<b>Engine Lubricant</b>	
2870791	Fogging Oil (12 oz. Aerosol)
2876244	PS-4 PLUS Performance Synthetic 2W-50 4-Cycle Oil (qt.)
2876245	PS-4 PLUS Performance Synthetic 2W-50 4-Cycle Oil (gal.)
<b>Gearcase / Transmission Lubricants</b>	
2873602	Premium AGL Synthetic Gearcase Lubricant (qt./95 l)
2873603	Premium AGL Synthetic Gearcase Lube (gal./3.8 l)
2876144	Active Descent Control (ADC) Fluid
2871653	Premium ATV Angle Drive Fluid (8 oz./237 ml)
2872276	Premium ATV Angle Drive Fluid (2.5 gal./9.5 l)
2870465	Pump for Gallon (3.8 l) Jug
2876251	Demand Drive LT Premium Fluid (8 oz./237 ml)
<b>Coolant</b>	
2871323	60/40 Coolant (gal./3.8 l)
2871534	60/40 Coolant (qt./95 l)
<b>Grease / Specialized Lubricants</b>	
2871312	Grease Gun Kit, Premium All Season
2871322	Premium All Season Grease (3 oz./89 ml cartridge)
2871423	Premium All Season Grease (14 oz./414 ml cartridge)
2871460	Starter Drive Grease
2871515	Premium U-Joint Lube (3 oz./89 ml cartridge)
2871551	Premium U-Joint Lube (14 oz./414 ml cartridge)
2871329	Dielectric Grease (Nyogel™)
2872073	Chain Lube, Aerosol (6.25 oz./185 ml)
2872348	Chain Lube, Aerosol (16 oz./473 ml)
<b>Additives / Miscellaneous</b>	
2871326	Carbon Clean Plus
2870652	Fuel Stabilizer
2872189	DOT 4 Brake Fluid
2871956	Loctite™ 565 Thread Sealant
2859044	Polaris Battery Tender™ Charger



# SPECIFICATIONS

<b>Sportsman X2 500 EFI</b>	
Maximum Weight Capacity	705 lbs. (320 kg) (includes operator, passenger, cargo, accessories)
Dry Weight	798 lbs. (362 kg) (base model)
Front Rack/Storage Box Capacity	90 lbs. (41 kg)
Rear Storage Box Capacity	400 lbs. (181 kg)
Receiver Hitch Tongue Capacity	120 lbs. (55 kg) (Rear box capacity and tongue weight not to exceed 400 lbs./181 kg)
Hitch Towing Rating	1225 lbs. (555.7 kg) on level ground
Unbraked Trailer Towing Capacity	1995 lbs. (905 kg)
Overall Length	93 in. (236 cm)
Overall Width	48 in. (122 cm)
Overall Height	48 in. (122 cm)
Wheelbase	57 in. (145 cm)
Ground Clearance	11 in. (28 cm)
Minimum Turning Radius	82 in. (208 cm) unloaded
Fuel Capacity	6 gal. (22.7 l)
Engine Oil Capacity	2 qts. (1.9 l)
Coolant Capacity	2.7 qts. (2.5 l)
Demand Drive Fluid Capacity	9.3 oz. (275 ml)
Transmission Oil Capacity	32 oz. (948 ml)
Engine	EH50PLE
Displacement	499 cc
Bore x Stroke	92 x 75
Alternator Output	350 w
Compression Ratio	10.2:1
Fuel System	Electronic Fuel Injection
Ignition System	Electronic Ignition
Ignition Timing	10 +/- 1 BTDC @ idle
Spark Plug	NGK BKR6E
Spark Plug Gap	.035+0.0/-0.004 in. (0.9+0.0/-0.1 mm)
Lubrication System	Dry Sump
Driving System Type	Automatic PVT (Polaris Variable Transmission)
Front Suspension	MacPherson strut with 8.2" (21 cm) travel
Rear Suspension	Progressive rate with 8.75" (22 cm) travel

\* Based on EU Directive 76/432/EC

# SPECIFICATIONS

## Sportsman X2 500 EFI

Transmission	Automatic EBS (Engine Braking System) with E-Z Shift H/L/N/R/P
Gear Reduction, Low	23.91:1
Gear Reduction, Reverse	21.74:1
Gear Reduction, High	10.57:1
Drive Ratio, Front	3.82:1
Tires/Pressure, Front	25x8-12 / 5 psi
Tires/Pressure, Rear	25x11-12 / 5 psi
Brakes, Front	Single-Control Hydraulic Disc
Brakes, Rear	Single-Control Hydraulic Disc
Brake, Auxiliary	Foot-Activated Hydraulic Disc
Brake, Parking	Hydraulic lock, all wheel
Headlight	1 Single Beam on Headlight Pod (50 watt) 2 Single Beam on Bumper (37.5 watt)
Taillights	8.26 watts
Brake Light	26.9 watts
Instrument Cluster	LCD

## Clutching (EBS Models)

Altitude		Shift Weight	Drive Clutch Spring	Driven Clutch Spring	Helix*
Meters (Feet)	0-1800 (0-6000)	10 WH PN 5630710	Blue/Green PN 7041157	Yellow PN 3234451	EBS PN 3234356
	1800-3700 (6000-12000)	10 RH PN 5630709	Blue/Green PN 7041157	Yellow PN 3234451	EBS PN 3234356

**\*EBS models require no helix/spring adjustment**

# SPECIFICATIONS

<b>Sportsman X2 800 EFI</b>	
Maximum Weight Capacity	705 lbs. (320 kg) (includes operator, passenger, cargo, accessories)
Dry Weight	830 lbs. (376 kg) (base model)
Front Rack/Storage Box Capacity	90 lbs. (41 kg)
Rear Storage Box Capacity	400 lbs. (181 kg)
Receiver Hitch Tongue Capacity	150 lbs. (68 kg) (Rear box capacity and tongue weight not to exceed 400 lbs./181 kg)
Hitch Towing Rating	1500 lbs. (680.4 kg) on level ground
Unbraked Trailer Towing Capacity*	1995 lbs. (905 kg)
Overall Length	93 in. (236 cm)
Overall Width	48 in. (122 cm)
Overall Height	48 in. (122 cm)
Wheelbase	57 in. (145 cm)
Ground Clearance	11 in. (28 cm)
Minimum Turning Radius	82 in. (208 cm) unloaded
Fuel Capacity	6 gal. (22.7 l)
Engine Oil Capacity	2 qts. (1.9 l)
Coolant Capacity	3.4 qts. (3.2 l)
Demand Drive Fluid Capacity	9.3 oz. (275 ml)
Transmission Oil Capacity	32 oz. (948 ml)
Engine	EH0760LE
Displacement	760 cc
Bore x Stroke	80x76
Alternator Output	500 Watts @3000 RPM
Compression Ratio	10:1
Fuel System	Electronic Fuel Injection
Ignition System	Electronic Ignition
Ignition Timing	Variable - ECU controlled
Spark Plug	RC7YC
Spark Plug Gap	.035 in. (0.9 mm)
Lubrication System	Pressurized Wet Sump
Driving System Type	Automatic PVT (Polaris Variable Transmission)
Front Suspension	MacPherson strut with 8.2" (21 cm) travel
Rear Suspension	Progressive rate with 8.75" (22 cm) travel

\* Based on EU Directive 76/432/EC

# SPECIFICATIONS

## Sportsman X2 800 EFI

Transmission	Automatic EBS (Engine Braking System) with E-Z Shift H/L/N/R/P
Gear Reduction, Low	23.91:1
Gear Reduction, Reverse	21.74:1
Gear Reduction, High	8.28:1
Drive Ratio, Front	3.82:1
Tires/Pressure, Front	25x8-12 / 5 psi
Tires/Pressure, Rear	25x11-12 / 5 psi
Brakes, Front	Single-Control Hydraulic Disc
Brakes, Rear	Single-Control Hydraulic Disc
Brake, Auxiliary	Foot-Activated Hydraulic Disc
Brake, Parking	Hydraulic lock, all wheel
Headlight	1 Single Beam on Headlight Pod (50 watt) 2 Single Beam on Bumper (37.5 watt)
Taillights	8.26 watts
Brake Light	26.9 watts
Instrument Cluster	LCD

## Clutching (EBS Models)

Altitude		Shift Weight	Drive Clutch Spring	Driven Clutch Spring	Helix*
Meters (Feet)	0-1800 (0-6000)	21-74 PN 5632117	Red/White PN 7043427	Red PN 3234452	66-56-33 BA500 EBS PN 3234604
	1800-3700 (6000-12000)	21-70.5 PN 5632106			

**\*EBS models require no helix/spring adjustment**

# **WARRANTY**

## **LIMITED WARRANTY**

Polaris Sales Inc., 2100 Highway 55, Medina, MN 55340, gives a SIX MONTH LIMITED WARRANTY on all components of the Polaris All Terrain Vehicle (ATV) against defects in material or workmanship. Polaris also gives a one year limited warranty on the final drive chain for failure due to defects. This warranty covers the parts and labor charges for repair or replacement of defective parts which are covered by this warranty. This warranty begins on the date of purchase. This warranty is transferable to another consumer during the warranty period through a Polaris dealer.

## **REGISTRATION**

At the time of sale, the Warranty Registration Form must be completed by your dealer and submitted to Polaris within ten days. Upon receipt of this registration, Polaris will record the registration for warranty. No verification of registration will be sent to the purchaser as the copy of the Warranty Registration Form will be the warranty entitlement. If you have not signed the original registration and received the customer copy, please contact your dealer immediately. **NO WARRANTY COVERAGE WILL BE ALLOWED UNLESS YOUR ATV IS REGISTERED WITH POLARIS.**

Initial dealer preparation and set-up of your ATV is very important in ensuring trouble-free operation. Purchasing a machine in the crate or without proper dealer set-up will void your warranty coverage.

# WARRANTY

## WARRANTY COVERAGE AND EXCLUSIONS: LIMITATIONS OF WARRANTIES AND REMEDIES

The Polaris limited warranty excludes any failures that are not caused by a defect in material or workmanship. This warranty does not cover accidental damage, normal wear and tear, abuse or improper handling. This warranty also does not cover any ATV that has been altered structurally, modified, neglected, improperly maintained, used for racing, or used for purposes other than for which it was manufactured, or for any damages which occur during trailer transit or as a result of unauthorized service or the use of unauthorized parts. In addition, this warranty does not cover physical damage to paint or finish, stress cracks, tearing or puncturing of upholstery material, corrosion, or defects in parts, components or the ATV due to fire, explosions or any other cause beyond Polaris' control.

This warranty does not cover the use of unauthorized lubricants, chemicals, or fuels that are not compatible with the ATV. The exclusive remedy for breach of this warranty shall be, at Polaris' exclusive option, repair or replacement of any defective materials, or components or products. THE REMEDIES SET FORTH IN THIS WARRANTY ARE THE ONLY REMEDIES AVAILABLE TO ANY PERSON FOR BREACH OF THIS WARRANTY. POLARIS SHALL HAVE NO LIABILITY TO ANY PERSON FOR INCIDENTAL, CONSEQUENTIAL OR SPECIAL DAMAGES OF ANY DESCRIPTION, WHETHER ARISING OUT OF EXPRESS OR IMPLIED WARRANTY OR ANY OTHER CONTRACT, NEGLIGENCE, OR OTHER TORT OR OTHERWISE. Some states do not permit the exclusion or limitation of incidental or consequential damages or implied warranties, so the above limitations or exclusions may not apply to you if inconsistent with controlling state law.

# WARRANTY

ALL IMPLIED WARRANTIES (INCLUDING BUT NOT LIMITED TO THE IMPLIED WARRANTIES OF MERCHANTABILITY AND FITNESS FOR A PARTICULAR PURPOSE) ARE LIMITED IN DURATION TO THE ABOVE SIX MONTH WARRANTY PERIOD. POLARIS FURTHER DISCLAIMS ALL EXPRESS WARRANTIES NOT STATED IN THIS WARRANTY. Some states do not allow limitations on how long an implied warranty lasts, so the above limitation may not apply to you if inconsistent with controlling state law.

## HOW TO OBTAIN WARRANTY SERVICE

If your ATV requires warranty service, you must take it to a Polaris dealer authorized to repair Polaris ATVs. When requesting warranty service you must present your copy of the Warranty Registration form to the dealer. (THE COST OF TRANSPORTATION TO AND FROM THE DEALER IS YOUR RESPONSIBILITY). Polaris suggests that you use your original selling dealer; however, you may use any Polaris Servicing Dealer to perform warranty service.

Please work with your dealer to resolve any warranty issues. Should your dealer require any additional assistance they will contact the appropriate person at Polaris.

This warranty gives you specific legal rights, and you may also have other rights which vary from state to state.

If any of the above terms are void because of state or federal law, all other warranty terms will remain in effect.

### Engine Oil

1. Mixing oil brands or using non-recommended oil may cause engine damage. We recommend the use of Polaris engine oil for your ATV.
2. Damage resulting from the use of non-recommended lubricants may not be covered by warranty.

### SPARK ARRESTOR

Polaris warrants that the spark arrestor in this vehicle will meet the efficiency requirements of 43 CFR 8340.1(c) for at least 1000 hours when subjected to normal use and when maintenance and installation are in accordance with Polaris recommendations.

## Exported Vehicles

EXCEPT WHERE SPECIFICALLY REQUIRED BY LAW, THERE IS NO WARRANTY OR SERVICE BULLETIN COVERAGE ON THIS VEHICLE IF IT IS SOLD OUTSIDE THE COUNTRY OF THE SELLING DEALER'S AUTHORIZED LOCATION.

This policy does not apply to vehicles that have received authorization for export from Polaris Industries. Dealers may not give authorization for export. You should consult an authorized dealer to determine this vehicle's warranty or service bulletin coverage if you have any questions.

This policy does not apply to vehicles registered to government officials or military personnel on assignment outside the country of the selling dealer's authorized location.

This policy does not apply to Safety Recalls.

## How to Get Service

### *In the Country where your vehicle was purchased:*

Warranty or Service Bulletin repairs must be done by an authorized Polaris dealer. If you move or are traveling within the country where your vehicle was purchased, Warranty or Service Bulletin repairs may be requested from any authorized Polaris dealer who sells the same line as your vehicle.

### *Outside the Country where your vehicle was purchased:*

If you are traveling temporarily outside the country where your vehicle was purchased, you should take your vehicle to an authorized Polaris dealer. You must show the dealer photo identification from the country of the selling dealer's authorized location as proof of residence. Upon residence verification, the servicing dealer will be authorized to perform the warranty repair.

### *If You Move:*

If you move to another country, be sure to contact Polaris Customer Assistance and the customs department of the destination country before you move. Vehicles importation rules vary considerably from country to country. You may be required to present documentation of your move to Polaris Industries in order to continue your warranty coverage. You may also be required to obtain documentation from Polaris Industries in order to register your vehicle in your new country.



# WARRANTY

## Exported Vehicles

### How to Get Service

#### *If Purchased From A Private Party:*

If you purchase a Polaris product from a private citizen outside of the country in which the vehicle was originally purchased, all warranty coverage will be denied.

#### **Notice**

If your vehicle is registered outside of the country where it was purchased, and you have not followed the procedure set out above, your vehicle will no longer be eligible for warranty or service bulletin coverage of any kind. (Vehicles registered to Government officials or military personnel on assignment outside of the country where the vehicle was purchased will continue to be covered by the basic warranty.)

#### *For questions call Polaris Customer Assistance:*

United States: 1-888-704-5290

Canada: 1-204-925-7100

# WARRANTY

## U.S.A. EPA Emissions Limited Warranty

This All Terrain Vehicle (ATV) or Off Road Utility Vehicle (ORUV) emissions limited warranty is in addition to the Polaris standard limited warranty for this vehicle.

Polaris warrants that this vehicle is; (1) designed, built, and equipped to conform at the time of initial sale with the requirements of 40 CFR 1051 and, (2) free from defects in materials and workmanship that may keep it from meeting these requirements.

The emissions warranty period for this vehicle begins on the date the vehicle is delivered to the original retail purchaser and ends 30 months (2.5 years) after that date, after 5000 km (3100 miles), or after 500 hours of operation, whichever comes first.

This emission-related warranty covers components whose failure would increase an engine's emissions, including electronic controls, fuel injection, exhaust-gas recirculation, aftertreatment, or any other system utilized in this vehicle to control emissions. Replacing or repairing other components not covered by this emissions warranty or the standard warranty is the responsibility of the owner; including the parts, labor and other costs associated with recommended maintenance.

The exclusive remedy for breach of this limited warranty shall be, at the exclusive option of Polaris, repair or replacement of any defective materials, components or products. THE REMEDIES SET FORTH IN THIS LIMITED WARRANTY ARE THE ONLY REMEDIES AVAILABLE TO ANY PERSON FOR BREACH OF THIS WARRANTY. POLARIS SHALL HAVE NO LIABILITY TO ANY PERSON FOR INCIDENTAL, CONSEQUENTIAL OR SPECIAL DAMAGES OF ANY DESCRIPTION, WHETHER ARISING OUT OF EXPRESS OR IMPLIED WARRANTY OR ANY OTHER CONTRACT, NEGLIGENCE OR OTHER TORT OR OTHERWISE.

ALL IMPLIED WARRANTIES (INCLUDING BUT NOT LIMITED TO ANY IMPLIED WARRANTIES OF MERCHANTABILITY AND FITNESS FOR A PARTICULAR PURPOSE) ARE LIMITED IN DURATION TO THE WARRANTY PERIOD DESCRIBED HEREIN. POLARIS DISCLAIMS ALL EXPRESS WARRANTIES NOT STATED IN THIS WARRANTY. Some states do not allow limitations on how long an implied warranty lasts, so the above limitation may not apply if it is inconsistent with the controlling state law.

This limited warranty excludes failures not caused by a defect in material or workmanship. This limited warranty does not cover damage due to accidents, abuse or improper handling, maintenance or use. This limited warranty also does not cover any engine that has been structurally altered, or any engine that has been used in racing competition. This limited warranty also does not cover physical damage, corrosion or defects caused by fire, explosions or other similar causes beyond the control of Polaris.

If you have any questions regarding your warranty rights and responsibilities, you should contact the Polaris Warranty Department at 1-888-704-5290.





## Free Manuals Download Website

<http://myh66.com>

<http://usermanuals.us>

<http://www.somanuals.com>

<http://www.4manuals.cc>

<http://www.manual-lib.com>

<http://www.404manual.com>

<http://www.luxmanual.com>

<http://aubethermostatmanual.com>

Golf course search by state

<http://golfingnear.com>

Email search by domain

<http://emailbydomain.com>

Auto manuals search

<http://auto.somanuals.com>

TV manuals search

<http://tv.somanuals.com>