

8" Portable DVD Player

PDM-0817

Operation Manual



20050128

 **Polaroid**[®]

Safety Instructions

Warning: This indicates that "There is a risk of injury or death".

Caution: This indicates that "There is a risk of injury or physical damage".

Before operation

Warning

Read and keep the operation manual. Before using the product, please carefully read this manual and follow all safety and operation instructions. Keep this manual for future reference.



Power supply: The power supply must correspond to the standard indicated on the product. If you are not sure of the power supply, please refer to the supplier or the local power company.



Ventilation: Do not place this unit on a bed, sofa, cloth or similar. Make sure there is adequate ventilation around the unit before operation.



Prevent objects and liquid from contacting the player
In order to avoid the risk of electric shock and fire caused by short circuits, do not insert objects into the player and do not spill liquids on the player. Do not place objects such as vases filled with liquids on the apparatus.



Do not use the product where it will get wet.

This could cause the product to ignite, or cause electrical shock or other malfunction.

Do not disassemble, repair or modify the product.

Do not cut the power cord to connect it to the power supply for another device. This could cause fire, electrical shock or other malfunction.



Always use only the accessories provided with the product.

Only use attachment/accessories specified by the manufacturer. Use only with the cart, stand, tripod, bracket, or table specified by the manufacture, or sold with the apparatus.

Safety Instructions

Do not install the product in a position where it will interfere with the operation of an automotive air bag.

The air bag may fail to operate properly or the product could become dislodged by airbag operation, causing an accident and/or injury.

Do not expose the product to excessive heat.

This could cause the product to start smoking or ignite, or cause electrical shock or other malfunction.

Unplug all the equipment before connecting.

Always ensure that the DVD player and any other electrical equipment connected to the DVD player is switched off and unplugged from the power supply before the player is connected.

Do not, under any circumstances, install the product in a place in a vehicle where the driver's ability to drive the car or the driver's field of vision will be impaired.

Install the product in a place where it doesn't interfere with the driver's field of vision either in front or behind or in a place where it interferes with the driver's ability to drive the car. This may lead to traffic accidents and/or injury.

Follow the instructions to connect the product to other electrical equipments.

To prevent damage to the unit, be sure to follow the connection diagram. Do not connect power to the unit until all other connections are completed.

Danger of explosion if battery is incorrectly replaced.

Replace the rechargeable lithium battery only with the same or equivalent type.

Caution

Install the product securely so that it will not shift out of place or fall. Loose screws or insecure installation may cause the product to shift out of position or fall while a vehicle is moving, resulting in an accident and/or injury.

Region code information: DVD players and discs are coded by region. If the region number described on the DVD disc does not correspond to the region number of this product, this product cannot play the disc. The region code of this unit is 1.

Safety Instructions

This product has been listed as class 1 laser product. The mark is on the rear panel.

The apparatus shall be connected to an AC power outlet with a protective grounded connection. Visible laser radiation when open and interlock failed or defeated. Avoid direct exposure to beam. Do not open the top cover while the unit is operating. There are no user serviceable parts inside the unit. Leave all servicing to qualified service personnel.

Beware of unit falling or tipping over when moving.

When a cart is used, use caution when moving the cart/apparatus combination to avoid injury from tip-over.



Before operation

Warning

Unplug the apparatus during lightning storms.

Never operate the product during lightning storms as this could cause the product to malfunction.

Do not operate the product if there is visible damage to the product.

If damage occurs, immediately stop using the product and contact the store from which you purchased your product. Continuing to use the product in this condition could cause accidents, fire or electrical shock.

The driver of a vehicle must not operate this product or watch the monitor.

It may distract the driver and cause an accident.

Refer all servicing to qualified service personnel.

Servicing is required when the apparatus has been damaged in any way, such as: damage to the power supply cord or plug, liquid spilled on the player, objects have fallen into the player, exposure to rain or moisture, the unit does not operate normally or has been dropped.

Safety Instructions

Caution

Notes on discs: Do not play discs that are damaged or warped, including discs with cracks, scratches or parts missing; discs with burrs; poor quality discs.



Route all cords so that they do not interfere with driving or with entering or exiting the car. Run the cords so that they do not wrap around the steering wheel, brake pedal, etc. or around your feet. Secure all the cords together.

Use the product at the proper volume setting.

Driving while you are unable to hear sounds around you or from outside the car can cause accidents.

Do not touch the color TFT LCD screen.

Do not place any heavy objects on the product.

Never put any heavy objects on the product. Doing so may cause damage to product.

Do not damage the cords.

Broken wires and short circuits can cause electrical shock or fire. Run the cords so that they do not get tangled in moving parts. Do not damage, tighten up, twist, or work on the cords. Do not place the cords near heat sources or put heavy objects on the cords.

Do not play discs in the wrong format.

For instance, if you add the ".cda" extension to a file that is not formatted as a CD file, a loud noise may be heard through the speakers, possibly damaging them and hurting your eardrums.

Do not swing from the product or pull it.

This may cause an accident, injury and/or malfunction. Be particularly careful that children follow this rule.

IMPORTANT FOR LASER PRODUCTS

1. CLASS 1 LASER PRODUCT
2. **DANGER:** Visible laser radiation when open and interlock failed or defeated. Avoid direct exposure to beam.
3. **CAUTION:** Do not open the top cover. There are no user service-able parts inside the unit. Leave all servicing to qualified service personnel. This unit complies with FDA regulation for radiation control of laser products.

Safety Instructions

Preservation and Cleaning

Warning

Do not use any volatile agents such as gasoline or paint thinners to clean the product. Never use any volatile materials to clean the product, because they may damage the surface of the player. Use a soft, dry cloth for cleaning.



Store in a proper place

Store the product in clean, dry place, avoid direct sunlight and moisture.

Caution

Unplug the product when not used for a long period of time.

Copyright Protection

This product incorporates copyright protection technology that is protected by U.S. patents and other intellectual property rights. Use of this copyright protection technology must be authorized by Macrovision, and is intended for home and other limited viewing uses only unless otherwise authorized by Macrovision. Reverse engineering or disassembly is prohibited.

Features

High-quality audio and video

Excellent sound: Dolby Digital delivers great sound.

AV In: External Audio, Video input can be connected to most external AV sources.

AV Out: Analog Audio output and video output.

Advanced Playing Functions

Compatibility: Compatible with DVD, CD and Picture CD disks.

On-screen Display: You can choose from English, Spanish or French for the On-screen Display language.

Particular Performance: Multi-speed, fast forward, fast backward and slow forward, slow backward.

Search by Time: Search for a certain track of a disk by selected time.

Last Memory Playback: Memorizes the stopped playback track and continues playing the disk from this spot when power is restored if the disc tray cover is not opened.

Special Functions: Supports screen aspect ratio changing, zooming in or out, multi-language caption, multi-angle viewing.

Other Special Functions







High Resolution: MPEG-2 decoding format achieves more than 500 lines of horizontal resolution.

Power Adapter Switch: Automatically adapts to voltage requirements in U.S and other countries.

Docking Jack: this unit designed with a docking jack on the bottom for connecting with an optional docking station. The docking station is integrated with connectors for peripheral devices to eliminate complicated connections and save valuable space around the player

Accessories

Accessories List

ITEM	NAME	QTY
	Remote Control (with battery)	1
	Owner's Manual	1
	Rechargeable Battery	1
	Audio/Video Cable	1
	Power Adapter	1
	Car Adapter	1

NOTE

Accessories and their parts numbers are subject to change without prior notice.

Contents

Safety Instructions	2
Features	7
Accessories	8
View of Unit	10
View of Side Panels	12
View of Unit Bottom	13
Remote Control	14
System Connections	17
Power Supply Preparation	19
Rechargeable Battery	20
Notes on Discs	23
Playback Operation	24
DVD Playback	25
CD Playback	29
Picture CD Playback	31
System Setup	34
Definitions	40
Troubleshooting	41
Specifications	43

View of Unit

Front View



1. TFT LCD

7" color TFT screen presents a high resolution picture.

2. Speakers

Two speakers output high quality stereo sound.

3. TITLE button

Press to display the disc title menu if the titles are coded in the disc.

4. MENU button

Press to enter to the disc menu.

5. ▼/◀,▲/▶ buttons

▼/▲: Press the direction buttons to select items.

◀/▶: Press to fast search backward and forward during disc playback.

6. **◀/⏮, ▶/⏭ buttons**
◀ / ▶ : Press the direction button to select items.
⏮/⏭: Press to play the previous track or the next track.
7. **ENT button**
Press to confirm your selection.
8. **MODE button**
Press to change the aspect ratio or change the brightness, contrast and color level.
(See page 20)
9. **▶||PLAY/PAUSE button**
Press to start playback or pause the playback.
10. **■ STOP button**
Press to stop playback. Press the ▶|| button to resume playback.
11. **ZOOM button**
Press to activate the zoom function to zoom in or out on the current image.
12. **Battery charge indicator**
Light turns red when the battery is in charging; turns green when the battery is fully charged.
13. **Main unit Power indicator**
Light turns green when the unit is under operation; turns red in standby mode.
14. **SETUP button**
Press to access the DVD setup menu.
15. **Remote sensor**
Receives signals from the remote control for operation. (Not included in all models.)
16. **A-B button**
Press to mark a segment to repeat between A and B.
17. **SLOW**
Press to activate slow playback.
18. **+/- button**
Press to increase/decrease the level of the selected item.
19. **Disc Tray Cover**
20. **OPEN button**
Press to open disc tray cover.

View of Side Panels

Right Side View

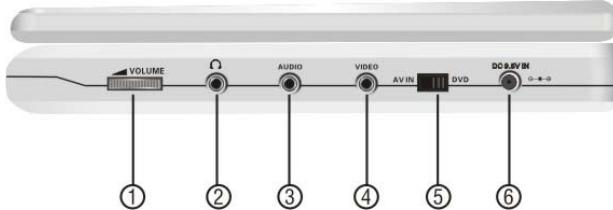

- 1. VOLUME Control**
For adjusting the sound level of speakers or headphones.
- 2. Headphone Jack**
When headphones are plugged into the unit, the speakers automatically turn off.
- 3. AUDIO input/output Jack**
For connecting to an external amplifier or audio source
- 4. VIDEO input/output Jack**
For connecting to an external monitor or video source
- 5. DVD/AV IN Switch**
Switch to AV IN to input the external AV source; switch to DVD to playback the disc
- 6. DC 9.5V IN Jack**
For connecting to power supply, including Car Adapter. (See page15)

Left Side View

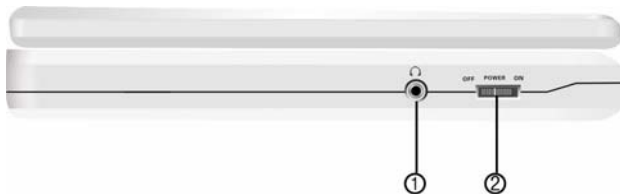

- 1. Headphone Jack**
When headphones are plugged into the unit, the speakers automatically turn off.
- 2. POWER ON/OFF Switch**
Switch the power on or off.

View of Unit Bottom

View of the bottom

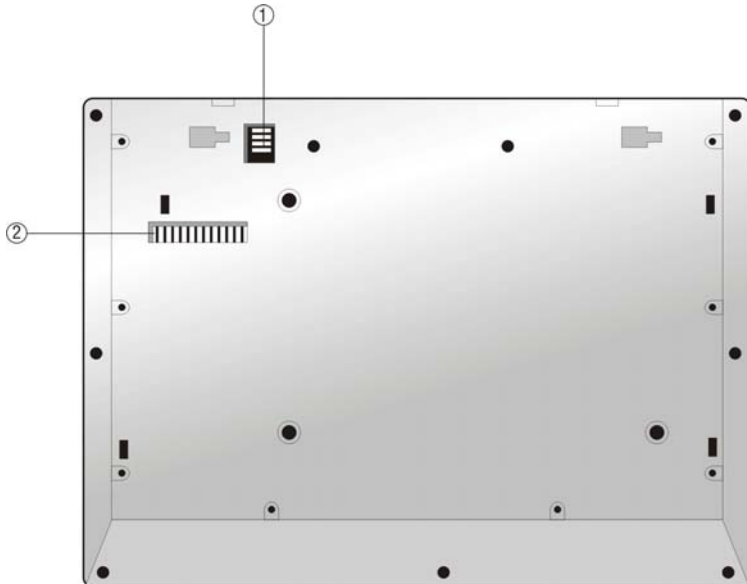

1. **Rechargeable Battery Contacts**

For connecting the rechargeable battery pack.

2. **Docking Jack**

This portable DVD player is designed with a Docking Jack on the bottom. The Docking Jack is designed for connecting to an optional external Docking Station for expanded functions. The Docking Station features an electrical connection interface that enables the portable DVD to effectively serve as a desktop DVD. It is integrated with connectors for peripheral devices to eliminate complicated connections and save valuable space around the unit. With a Docking Station, you can enjoy the expansion possibilities of desktop DVD with the portability of a portable DVD.

Remote Control

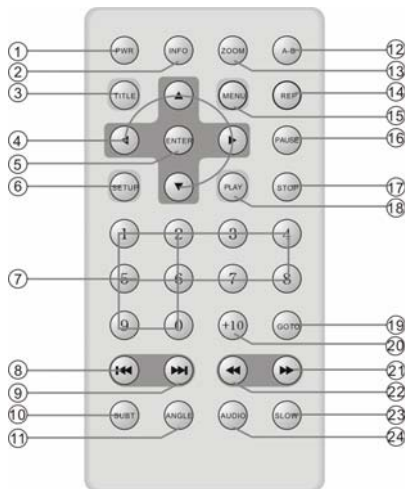

- 1. PWR button**
Press to access standby mode or playback mode.
- 2. INFO button**
Press to display the detailed information of the disc during playing. Press this button again to exit from the information display.
- 3. TITLE button**
Press to display title menu if it exists in the disc.
- 4. Direction buttons**
Press to select different options.
- 5. ENTER button**
Press to access playback, or confirm your selection
- 6. SETUP button**
Press to enter the player's system setup.
- 7. 0-9 Number buttons**
Press to select an option in the menu.
- 8. ⏮ PREVIOUS button**
Press to return to the previous list or the previous track or chapter. If it is a DVD disc, it needs to press this button twice to return to the previous track.
- 9. ⏭ NEXT button**
Press to skip to the next list, track or chapter.

- 10. SUBT button**
Press to select different subtitle languages if there are multiple subtitle languages existing in the disc.
- 11. ANGLE button**
Press to access various camera angles playback if the DVD disc contains multiple camera angles.
- 12. A-B Repeat button**
Press to play a certain selected segment repeatedly.
- 13. ZOOM button**
Press to realize various zoom effects.
- 14. REP button**
Press to repeat a chapter, a title, a track or the whole disc.
- 15. MENU button**
Press to display or cancel the menu.
- 16. PAUSE button**
Press to pause the playback.
- 17. STOP button**
Press to stop the playback. Then press PLAY button to resume playback from the stopped spot. Press this button twice to stop playback completely.
- 18. PLAY button**
Press to begin to play.
- 19. GOTO button**
Press to select the desired disc starting time, track or title.
- 20. +10 button**
Press this button and the additional number buttons to select item numbers which are greater than 9.
- 21. » FWD SCAN button**
Press to search forward fast.
- 22. « REV SCAN button**
Press to search backward fast.
- 23. SLOW button**
Press to activate slow playback function.
- 24. AUDIO button**
Press to select different languages when a DVD disc which contains multiple audio languages is played. Press to select different audio track when a CD disc is played.

Remote Control

Installation Steps

Follow the steps below to install the battery.

Step1: Pull the battery holder out from the remote control in the direction of the arrow.

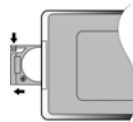

Step 2: Load a new battery properly with the (+) side up.

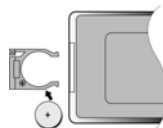

Step3: Insert the battery holder back into the remote control.

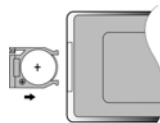

Battery Property

Battery Type: CR2025 3V

Battery Life: Approximately 1 year under normal use (at room temperature).

Caution

1. Improper use of the battery may cause overheating, explosion or ignition, which can result in an injury or fire. Battery leakage may damage the remote control.
2. Do not expose the remote control unit to direct sunlight.
3. Do not recharge, disassemble, deform or heat the battery.
4. Do not put the battery in fire or water.
4. Immediately replace the exhausted battery.

System Connections

- Always ensure that the DVD player, TV and any other electrical equipment to be connected with are switched off and unplugged from the power supply.
- Ensure that you observe the color coding when connecting audio and video cables.

Connecting to TV

Audio/Video connections

Follow the drawings below to connect the DVD player to a TV's Audio/Video inputs with Audio/Video cables.



Connecting to Amplifier

Refer to your Audio equipment's manual before connection.

Follow the drawings below to connect the DVD player to an AV amplifier.

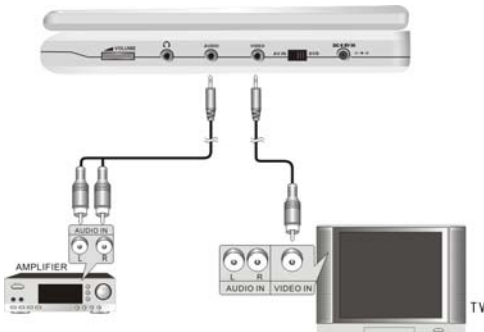

System Connections

Connecting to External AV Source

The player supports an AV signal input function. Use the audio/video cable to connect the unit to an external AV signal source such as a DVD, VCR etc. After connecting, switch the DVD/AV IN to AV IN.



Connecting to Headphone

Connect headphones to the headphone jack on the right side of the unit.



When headphone is connected, the speakers will automatically turn off.

Power Supply Preparation

Using the AC Adapter

The player is supplied with an AC adapter for powering the unit and charging the battery.

1. Connect AC adapter to the right side of the DVD player in the jack marked DC 9.5V IN, as shown on the right.
2. Plug the two-prong end of the power cord into a grounded electrical outlet. The power indicator lights red.



Note: Turn player's power off before unplugging.

Using the Car Adapter

The player is supplied with a Car Adapter for powering the unit and charging the battery while in a vehicle.

Connect the Car Adapter Power Plug to the unit's power jack and plug the other end to the vehicle's 12V accessory / cigarette socket, as shown on the right figure.

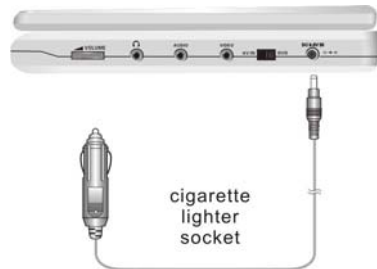

Attention

- Do not operate the unit or view video software while driving a vehicle.
- Place the unit in a proper position for viewing.
- Detach the battery pack when using the AC or car adapter as the power source.
- Disconnect the player from the Car Adapter when starting the vehicle.

Rechargeable Battery

About Rechargeable Battery Pack

Your portable DVD player comes with a lithium ion rechargeable battery that attaches to the rear of the DVD player. Charge the battery fully before initial use. Charging time is normally about 5 hours. A fully charged battery delivers about 3 hours of use, but playing time varies from disc to disc. If the battery will not be used for a long period of time, fully charge the battery prior to storage.

Working conditions and precautions for the rechargeable battery

- New batteries should be fully charged before initial use.
- Battery should only be used and charged when temperatures are between 32 - 100F.
- Never put the battery in fire or water.
- Do not expose the battery to high temperatures or store in hot, sunny places.
- Maintain well-ventilated conditions around the product to avoid overheating. Don't put the product on a bed, sofa or anything that may block ventilation to the product.
- Do not short the battery terminals.
- Do not open the battery.
- Detach the battery after charging is complete. When charging the battery pack, the charge light will turn red, when the charging is complete, the light will turn green.
- Detach the battery when it is not in use.
- When the battery is weak, "Low Power" will appear on the LCD screen and about one minute later, the player will power OFF automatically.

Warning:

Do not touch any metal objects to the battery connectors, as it will put the battery in standby mode. To exit the standby mode, connect the battery and DVD player to AC or DC power

Rechargeable Battery

Attaching the Battery Pack

Refer to the following steps for attaching the Battery Pack:

1. Make sure the player is off and the AC or car adapter is disconnected.
2. Place the DVD player on a soft and smooth surface with the bottom of the unit facing up.
3. With one hand on the DVD player to prevent it from moving, take the battery and align the plastic tabs on the battery pack with holes on the player, and push the battery pack into the DVD player.
4. The battery pack will click into place.

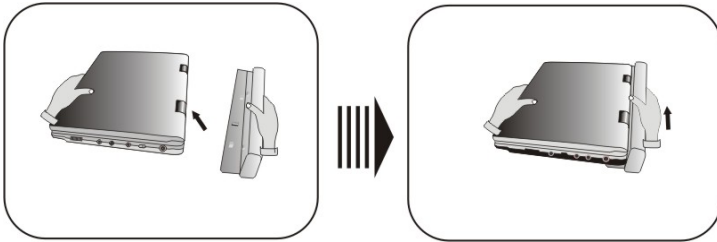

Charging the Battery Pack

The battery pack must be attached to the DVD player to charge it using the supplied AC or car power adapter.

1. Attach the battery pack to the DVD player, as shown above.
2. Plug the supplied AC Power Adapter into the player's power jack marked "DC 9.5V IN", located on right side of the DVD Player.
3. Plug the other end of the AC Power Adapter Cord into a household AC Outlet as shown below.



Rechargeable Battery

Detaching the Battery Pack

If the DVD Player is not going to be used for long periods of time, the battery pack should first be fully charged and then detached. When the DVD Player is turned OFF, the DVD Player is still consuming some power in STANDBY mode. This will eventually discharge the battery.

Make sure the power is turned OFF and the AC or car adapter is disconnected before detaching the Battery Pack.

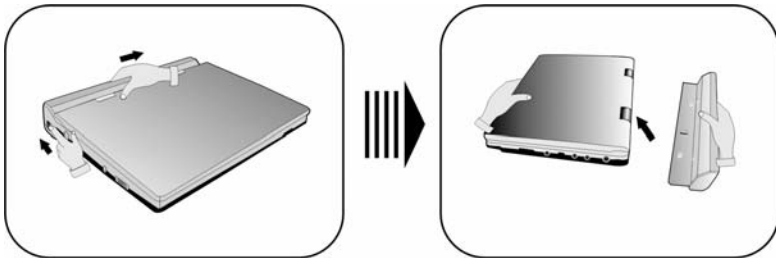

To detach the Battery Pack:

1. Push the battery pack latch toward the rear of the player and slide the rechargeable battery from the main unit (see drawings below).
2. Store the rechargeable battery in a safe place.



Notes on Discs

Compatible Disc Formats

	DISC LOGO	DIAMETER	PLAYBACK TIME/ PLAYABLE SIDES
DVD		12cm	133 min (SS-SL)
			242 min (SS-DL)
			266 min (DS-SL)
			484 min (DS-DL)
		8cm	41 min (SS-SL)
			75 min (SS-DL)
82 min (DS-SL)			
150 min (DS-DL)			
CD		12cm	74 min
		8cm	20 min
JPEG		12cm	

Operation methods of some DVD discs are specified by the software manufacturer. Please follow the instructions for the disc.

Care of Discs

Handling Discs

When loading or removing discs, do not touch their playing surfaces. Hold the disk as shown at the right.



Cleaning

Fingerprints or stains on the disc may affect the quality of sound and picture. To clean your discs, wipe the surface with a soft clean cloth. If necessary, moisten a soft cloth with diluted mild detergent to remove heavy dirt or fingerprints.

Do not wipe in a circular direction as shown on the right (concentric scratches on the playing surface can cause noise). Gently wipe from the center of the disc to the outer edge as the lower figure.



Playback Operation

READ THE FOLLOWING INSTRUCTIONS CAREFULLY BEFORE USING YOUR DVD PLAYER FOR THE FIRST TIME.

WARNING: Do not play poor-quality discs to avoid damaging the lens.



Pre-operation

1. Connect the unit to power supply through the provided AC adapter.
2. Switch "POWER ON/OFF" to "ON" on the left panel to turn on the DVD player. The main unit power indicator lights green and screen displays the  Polaroid logo.
3. Press the OPEN button on the unit to open the disc tray cover, put a disc in the disc tray with printed side facing up. Close the disc cover. (See below.)



4. The player will search the disc and play it automatically.
5. Adjust the volume with the VOLUME control on the right panel to the desired level.
6. To turn the player off, switch the "POWER ON/OFF" on the left panel to "OFF".

Basic Operation

MODE button   Press the MODE button to enter the brightness, contrast or color adjustment mode. Adjust these levels with + and - buttons. Press the MODE button repeatedly to change the aspect ration between 16:9 and 4:3. See the below for details:



Playback Operation

DVD Playback

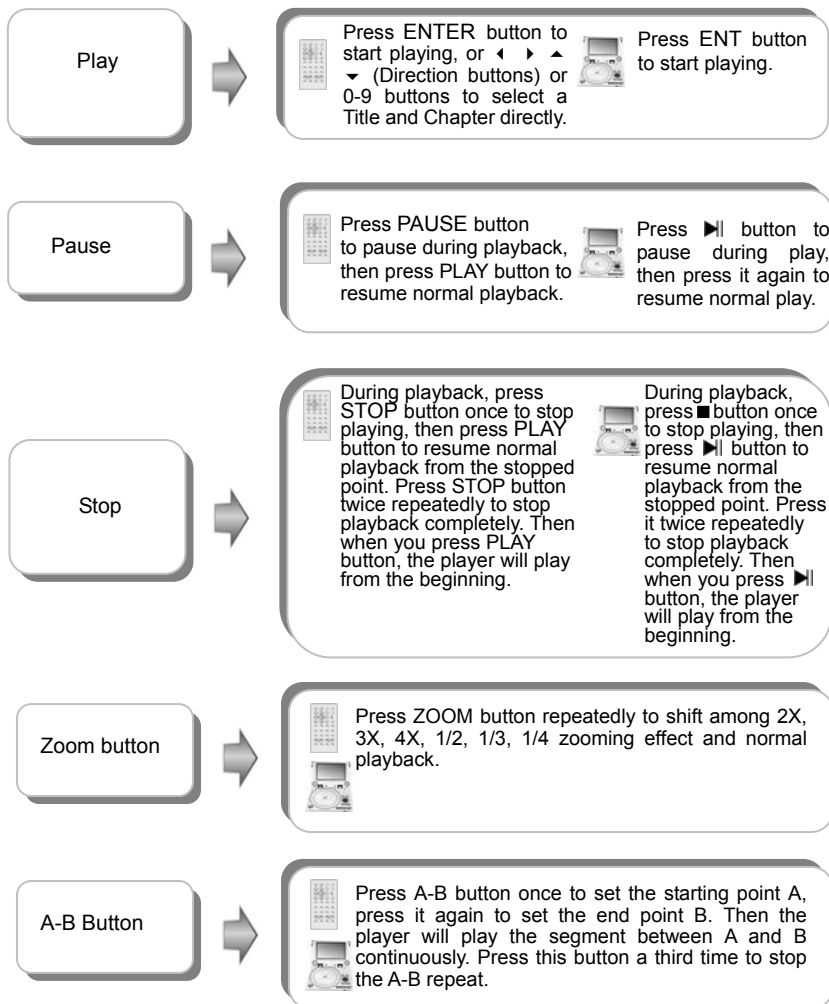

Playback Operation

DVD Playback (continued)

TITLE button



Press TITLE button during play. The title menu will appear on the screen.

Press ◀ ▶ ▲ ▼ (direction buttons) to select the title or disc menu item you wish to play, then press ENTER button to confirm your selection. Or press 0-9 buttons to select the item you prefer directly.

MENU button



Press MENU button during play. The root menu will appear on the screen.

Press ◀ ▶ ▲ ▼ (direction buttons) to select the item you wish to play, then press ENTER button to confirm your selection. Or press 0-9 buttons to select the item you prefer directly.

◀◀&▶▶ buttons



Press ◀◀ button once to go to the beginning of the current chapter. Press it twice repeatedly to go to the beginning of the previous chapter.

Press ▶▶ button to play the next chapter.

▶▶&◀◀ buttons



Press ▶▶ button to play fast forward. Press it repeatedly and fast forward playback will start at the speed of 2X, 4X, 8X, 16X, 32X and normal in sequence. Press ◀◀ button to fast reverse. Press it repeatedly and fast reverse playback will start at the speed of 2X, 4X, 8X, 16X, 32X and normal in sequence.

Press PLAY button on the remote control to return to normal playback.

SLOW button



Press SLOW button repeatedly and slow playback will start at the speed of 1/2, 1/4, 1/8, 1/16 forward, 1/2, 1/4, 1/8, 1/16 backward or normal playback in sequence. Press PLAY button to resume normal playback.

Playback Operation

DVD Playback (continued)

INFO button



Press INFO button for detailed information about the disc during disc playback. Press it repeatedly to display as follows:

Title Elapsed → *Title Remain* → *Chapter Elapsed*
→ *Chapter Remain* → *Display Off*

AUDIO button



DVD discs can contain up to 8 audio bit streams. For example: English, Spanish, French etc. To select the audio bit stream you prefer, press AUDIO button during playback. The DVD player will play the next bit stream every time you press AUDIO button in succession, if they exist.

SUBT button



When a DVD disc is playing, press SUBT button to select a subtitle language or to turn the subtitle off. A DVD disc can be recorded with up to 32 subtitles. Press SUBT button repeatedly, the mode of subtitles will cycle as follows:

SUBTITLE 1/N: Subtitle 1 appears on the screen.

SUBTITLE 2/N: Subtitle 2 appears on the screen.

SUBTITLE */N: Subtitle * appears on the screen

SUBTITLE OFF: No subtitle.

"N" refers to the total number of subtitles that the current disc contains.

NOTE: This function is only available for DVD discs recorded with multi-subtitles

REP button



Press REP button to repeat a Chapter, Title, All or cancel repeat in sequence.

Playback Operation

DVD Playback (continued)

ANGLE
button



Press ANGLE button to play the disc in multi-angle mode. Multi-angle means that a scene is shot from different angles so that the audience can watch from any angle, like the drawings below:



If there are multiple angles in a scene, you can use the ANGLE button to select the angle you like to view. Press the ANGLE button repeatedly to view from different angle.

NOTE: This function is only available for the DVD discs coded with multi-angle material.

GOTO button



Press GOTO button to select desired disc starting time, track or title:



Press \blacktriangle \blacktriangledown buttons to move the yellow bar to the item you prefer, then press ENTER button (on the front panel) or PLAY button to confirm:

- ✦ The corresponding item is highlighted (for Title, Chapter, Angle, Tt Time <Total Time>, Ch Time <Chapter Time>), use 0-9 buttons to select number values directly.
- ✦ The sub-menu of the selected item is displayed (for Audio, Subtitle, Repeat, Time Disp.<Time Display>), use \blacktriangle \blacktriangledown buttons to move the yellow bar to the item you prefer, then press ENTER button (on the front panel) or PLAY button to confirm.

Press GOTO button again to resume normal play.

Playback Operation

CD Playback

When a CD disc is loaded, the player will play it automatically by the default sequence of the disc. You can use ⏮, ⏭ or number buttons to select a certain track to play.

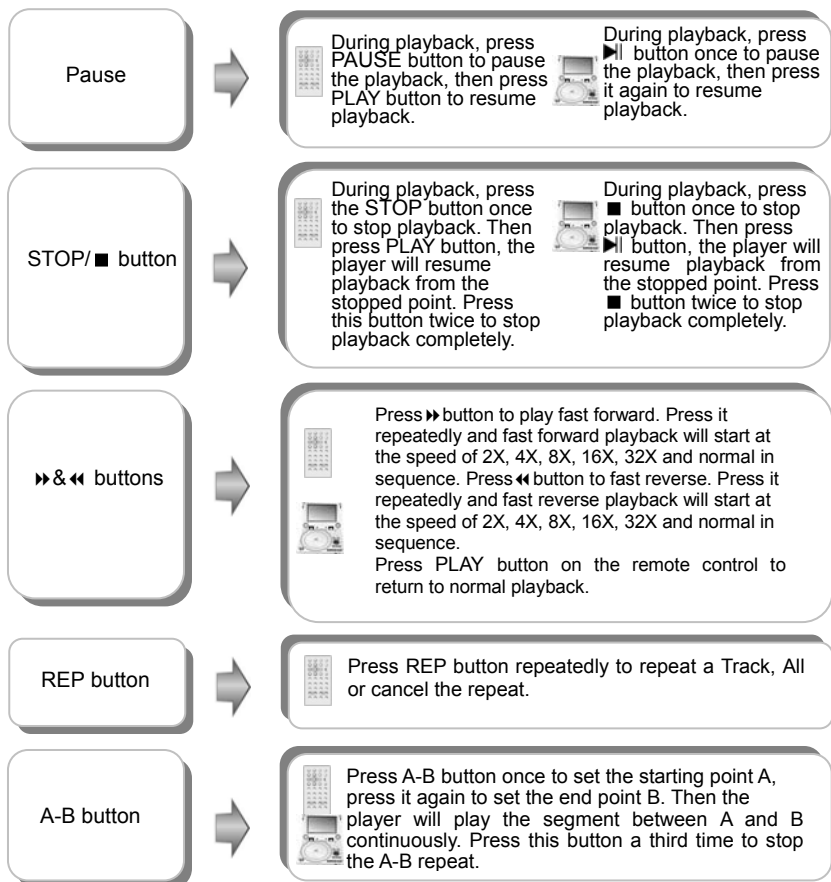

Playback Operation

CD Playback (continued)

⏮️&⏭️ buttons



Press ⏮️ button to play the previous chapter.
Press ⏭️ button to play the next chapter.

GOTO button



Press GOTO button to select desired disc starting time, track starting time or track. During CD playback, press it repeatedly to display as follows:
Disc Go To:--:-- Track Go To:--:-- Select Track:--/N
N refers to the total track number of the disc.
Use 0-9 buttons on the remote control to select directly.

INFO button



Press INFO button repeatedly for detailed information about the disc during playback:



Note: * refers to the playing track number.
N refers to the total track numbers of the disc.

AUDIO button



Press AUDIO button repeatedly to select desired sound effect:
Mono Left → *Mono Right* → *Mix-Mono* → *Stereo*

Playback Operation

Picture CD Playback

Pre-operation

1. Load a Picture CD in the disc tray. The player will search for the disc automatically.
2. The screen displays the root folder with several subdirectories/subfolders. Use \blacktriangle , \blacktriangledown buttons to select a desired folder. Then press \blacktriangleright , ENTER, PLAY or $\blacktriangleright||$ button on the remote control or front panel to confirm your selection.
3. The screen enters the selected subfolder to view the files. Use \blacktriangle , \blacktriangledown buttons to select the desired file. Then press ENTER, PLAY or $\blacktriangleright||$ button on the remote control or front panel to confirm your selection.
4. Press \blacktriangleleft button to return to last folder or directory, or move the yellow bar to  .. then press ENTER, PLAY or $\blacktriangleright||$ button on the remote control or front panel to return to the last folder or directory.

Note: Many discs have other items besides pictures.

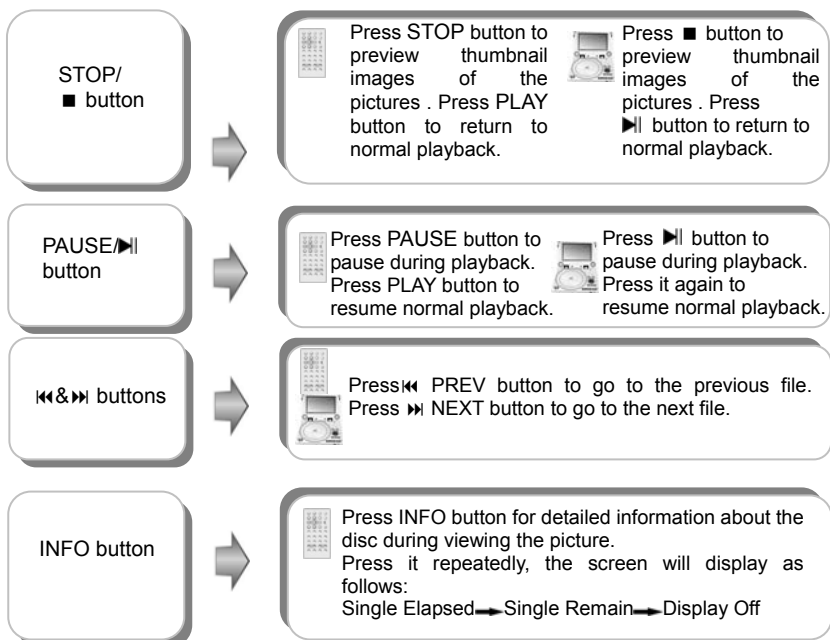

Playback Operation

Picture CD Playback (continued)

REP button



Press REP button to repeat a file, folder in sequence.

Press it repeatedly, the display will be as follows:

Shuffle → *Random* → *Single* → *Repeat One* → *Repeat All* → *Repeat Off*

- ◇ Shuffle plays files of current folder randomly without obeying the original order.
- ◇ Random plays files of current folder randomly without obeying the original order. After playing the whole folder, play will be stopped automatically.
- ◇ Single plays only the current file. As soon as it comes to an end, play will be stopped.
- ◇ Repeat One repeats the current file.
- ◇ Repeat All repeats all files of the current folder according to their original order.
- ◇ Repeat Off cancels the repeat.

This function is only available under normal play mode, it doesn't work under repeat status.

MENU button



Press MENU button during playback to return to root folder.

GOTO button



Press GOTO button to select the desired folder or file.

Press 0-9 buttons to select your favorite folder or file directly.

Playback Operation

Picture CD Playback (continued)

Picture Rotate

While viewing a picture, use direction buttons \blacktriangle , \blacktriangledown , \blacktriangleright , \blacktriangleleft to rotate the picture.

Press \blacktriangleright button to rotate the current picture clockwise:

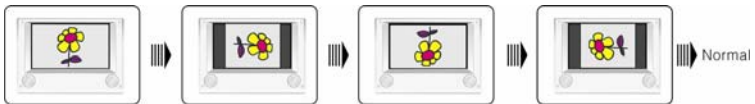

Press \blacktriangleleft button to rotate the current picture anti-clockwise:

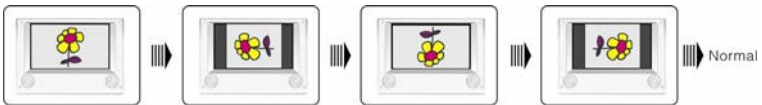

Press \blacktriangle button to rotate the current picture flip horizontal:

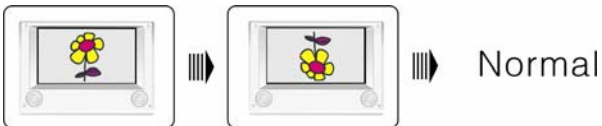

Press \blacktriangledown button to rotate the current picture flip vertical:

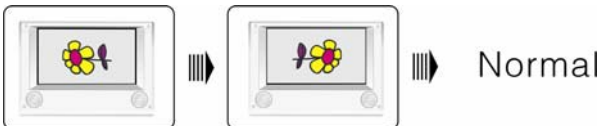

System Setup

You can change the default settings of this unit to customize its performance to your own preferences.

Note: Set the system up while play is stopped or there is no disk in the player.

To set up your system:

1. Press the SETUP button on the front panel.
2. The setup menu will appear on the screen. It includes General Setup Page, Speaker setup page, Dolby digital setup, Video setup page and Preference page. You can exit the setup menu by pressing the SETUP button again at any time.
3. Press the ◀ or ▶ (direction buttons) on the front panel to select a sub-menu to set up.
4. Press the ▲ or ▼ button on the front panel to select the item that you want to set up in the sub-menu.

General Setup Page

-- General Setup Page --	
Tv Display	Ps
Angle Mark	On
Osd Lang	Eng
Captions	Off
Screen Saver	On
Last Memory	Off

Go To General Setup Page

The items included in this sub-menu are shown as the left.

-- General Setup Page --		
Tv Display	Ps	Normal/PS
Angle Mark	On	Normal/LB
Osd Lang	Eng	Wide
Captions	Off	
Screen Saver	On	
Last Memory	Off	

Set Tv Display Mode

1.TV Display

This item is used to set TV display mode. Press the ▲ or ▼ button to highlight this item. Press the ENT or ▶ button to enter the item. It includes Normal/PS, Normal/LB and Wide, Wide by default. Press the ▲ or ▼ button to choose the proper one. Press the ENT button to confirm your selection. Press the ◀ direction button to exit from this item.

Note: Select Normal/PS or Normal/LB when a 4:3 TV is connected.

Select Wide when a 16:9 wide screen TV is connected.

System Setup

General Setup Page (continued)

-- General Setup Page --

Tv Display	Ps	
Angle Mark	On	On
OsD Lang	Eng	Off
Captions	Off	
Screen Saver	On	
Last Memory	Off	

Set Angle Mark

2.Angle Mark

This item is used to turn the Angle Mark on or off. Press the ▲ or ▼ button to highlight this item. Press the ENT or ► to enter the item.

Press the ▲ or ▼ button to choose angle mark on or off.

Press the ENT button to confirm your selection. Press the ◀ direction to exit this item.

-- General Setup Page --

Tv Display	Ps	
Angle Mark	On	
OsD Lang	Eng	English
Captions	Off	French
Screen Saver	On	Spanish
Last Memory	Off	German Italian

Set OsD Language

3.OSD Language

This item is used to set the OSD (on-screen display) language. Press the ▲ or ▼ button to highlight this item. Press the ENT or ► to enter the setup of this item.

It includes English, French, Spanish, German and Italian, English by Default.

Press the ▲ or ▼ button to choose the proper one. Press the ENT button to confirm your selection.

Press the ◀ direction button to exit this item.

-- General Setup Page --

Tv Display	Ps	
Angle Mark	On	
OsD Lang	Eng	
Captions	Off	On
Screen Saver	On	Off
Last Memory	Off	

Closed Caption

4.Captions

This item is used to turn the captions on or off during playing. Press the ▲ or ▼ button to highlight this item. Press the ENT or ► to enter the setup of this item.

The default setting of this item is off.

Press the ▲ or ▼ button to choose on or off.

Press the ENT button to confirm your selection.

Press the ◀ direction button to exit this item

-- General Setup Page --

Tv Display	Ps	
Angle Mark	On	
OsD Lang	Eng	
Captions	Off	
Screen Saver	On	On
Last Memory	Off	Off

Screen Saver

5.Screen Saver

This item is used to turn the screen saver on or off. Press the ▲ or ▼ button to highlight this item.

Press the ENT or ► to enter the setup of this item. The default setting of this item is on.

Press the ▲ or ▼ button to choose on or off.

Press the ENT button to confirm your selection.

Press the ◀ direction button to exit this item.

System Setup

General Setup Page (continued)

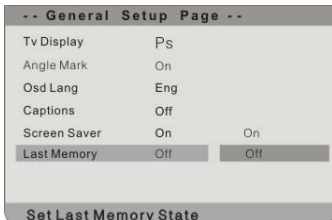

6. Last Memory

This item is used to set last memory state.
Note: The last memory refers to resume playback from the point that you stopped last time.
Press the ▲ or ▼ button to highlight this item.
Press the ENT or ► to enter the item.
The default setting of this item is off.
Press the ▲ or ▼ button to choose on or off.
Press the ENT button to confirm your selection.
Press the ◀ direction button to exit this item.

Speaker Setup Page

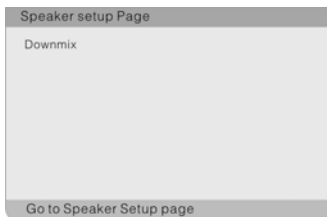

The item included in this sub-menu is shown as the left.

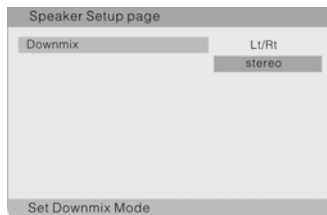

1. Downmix

This item is used to set downmix mode.
Press the ▲ or ▼ button to highlight this item.
Press the ENT or ► to enter the item.
It includes Lt/Rt and stereo, stereo by default.
Note: The function of Lt/Rt is to output mixed audio in the format provided by Dolby. The function of stereo is to output stereo signal.
Press the ▲ or ▼ button to choose the proper one.
Press the ENT button to confirm your selection.
Press the ◀ direction button to exit this item.

Dolby Digital Setup



The items included in this sub-menu are shown as the left.

System Setup

Dolby Digital Setup (continued)

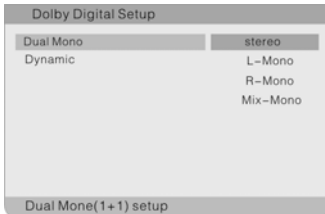

1. Dual Mono

This item is used to set the channel output mode. Press the \blacktriangle or \blacktriangledown button to highlight this item. Press the ENT or \blacktriangleright to enter the item. It includes stereo, L-Mono, R-Mono and Mix-Mono, Stereo by default. Press the \blacktriangle or \blacktriangledown button to choose the proper one. Press the ENT button to confirm your selection. Press the \blacktriangleleft direction button to exit this item.

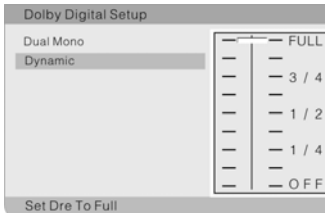

2.Dynamic

This item is used to adjust linear dynamic compression rate to get different signal compression effects. Press the \blacktriangle or \blacktriangledown button to highlight this item. Press the ENT or \blacktriangleright to enter the setup of this item. Then the item will show as the left. Press the \blacktriangle or \blacktriangledown to choose the proper level. Press the ENT button to confirm your selection. Press the \blacktriangleleft direction button to exit this item.

Video Setup Page

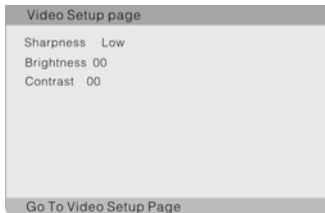

The items included in this sub-menu are shown as the left.



1.Sharpness

This item is used to adjust the sharpness of the Screen. Press the \blacktriangle or \blacktriangledown button to highlight this item. Press the ENT or \blacktriangleright to enter the item. It included High, Medium and Low, Low by default. Press \blacktriangle or \blacktriangledown button to choose the proper one. Press ENT button to confirm your selection. Press \blacktriangleleft direction button to exit this item.

System Setup

Video Setup Page (continued)



2. Brightness

This item is used to adjust brightness level of the Screen.

Press the \blacktriangle or \blacktriangledown button to highlight this item. Press the ENT or \blacktriangleright to enter the item.

Press the \blacktriangle or \blacktriangledown button to adjust to desired level. The default level is 00.

Press the ENT button to confirm your selection.



3. Contrast

This item is used to adjust contrast level of the Screen.

Press the \blacktriangle or \blacktriangledown button to highlight this item. Press the ENT or \blacktriangleright to enter the item.

Press the \blacktriangle or \blacktriangledown button to adjust to desired level. The default level is 00.

Press the ENT button to confirm your selection.

Preference page



The items included in this sub-menu are Shown as the left.

Note: *This sub-title can only appear in the state that no disc is in the DVD drive.*



1. Audio

This item is used to set the audio output language. Press \blacktriangle or \blacktriangledown button to highlight this item.

Press the ENT or \blacktriangleright button to enter the item.

The available languages are English, French, Spanish, Chinese, Japanese, Korean, Russian and Thai, English by default.

Press the \blacktriangle or \blacktriangledown button to choose the preferred Language.

Press the ENT button to confirm your selection.

Press the \blacktriangleleft button to exit this item.

System Setup

Preference page (continued)



2. Subtitle

This item is used to set the subtitle language. Press the ▲ or ▼ button to highlight this item. Press the ENT or ► button to enter the item. The available languages are English, French, Spanish, Chinese, Japanese, Korean, Russian and Thai, English by default. Press the ▲ or ▼ button to choose the preferred language. Press the ENT button to confirm your selection. Press the ◀ direction button to exit this item.

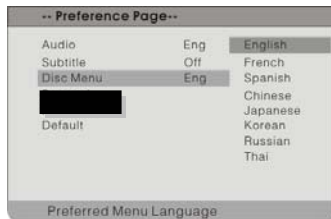

3. Disc Menu

This item is used to set the language of disc menu. Press the ▲ or ▼ button to highlight this item. Press the ENT or ► button to enter the item. The available languages are English, French, Spanish, Chinese, Japanese, Korean, Russian and Thai, English by default. Press the ▲ or ▼ button to choose the preferred language. Press the ENT button to confirm your selection. Press the ◀ direction button to exit this item.

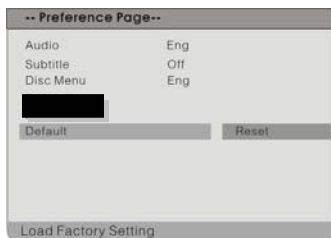

4. Default

This item is used to reset the unit. Press the ▲ or ▼ button to highlight this item. Press the ENT or ► button to enter this item. Press the ENT button to reset. Then all the settings of your unit will return to the original status.

Definitions

Dolby Digital

Dolby Digital is a technology developed by Dolby Laboratories. Audio tracks encoded in Dolby Digital can reproduce from one to 5.1 discrete channels of excellent quality audio.

Letterbox screen

This refers to a screen on which the playback picture of wide-screen DVDs appears with black bands running along the top and bottom.

Pan & Scan screen

This refers to a screen on which the playback picture of wide-screen DVDs is cut off at the left and right sides.

Title, Chapter (DVD)

DVDs are divided into some large sections (titles) or some small sections (chapters). Each section is numbered: these numbers are called "Title number" or "Chapter number".

Title 1	Title 2
Chapter 1	Chapter 1
Chapter 2	Chapter 2
.....

Track (CD)

CDs are divided into some sections (tracks). Each section is numbered; these numbers are called "Track numbers".

Track 1	Track 2	Track 3
---------	---------	---------	-------

JPEG

JPEG is a common picture format that has small file size and low quality loss rate of picture. Hundreds of pictures can be stored on a disc in this format. To create a digital photo album from film pictures, have a photo processing shop make a "PICTURE CD" in JPEG format.

The figure on the right displays the root folder, folders and files of a typical picture CD.

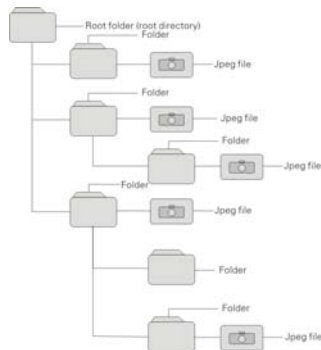

Troubleshooting

If you suspect there is something wrong with the DVD player, immediately turn the power off. Disconnect the power connector and check that there is no smoke or excessive heat coming from the unit.

Never open or try to repair the unit yourself. There are no user serviceable parts inside.

PROBLEM	POSSIBLE CAUSE	POSSIBLE SOLUTION
<p>The player cannot play.</p>	<p>The disc cover may not be closed.</p>	<p>Close the disc cover.</p>
	<p>There may not be a disc in the DVD drive.</p>	<p>Put a disc into the DVD drive.</p>
	<p>The disc may not be put in the right way.</p>	<p>Put the disc in with the label side up.</p>
	<p>The disc may be dirty or warped.</p>	<p>Clean or change the disc.</p>
	<p>The player's region code may not be the same as the region code of DVD disc.</p>	<p>Make sure the player's region code is the same as the code of DVD disc.</p>
	<p>There may be water on the lens.</p>	<p>Remove the disc and shut the player off for at least two hours to dry.</p>
	<p>The battery may be dead.</p>	<p>Charge the battery or use the AC or car adapter.</p>
<p>There is no sound.</p>	<p>The system connection may be not correct.</p>	<p>Connect the system correctly.</p>
	<p>The speaker volume may be turned down.</p>	<p>Turn the volume up with the volume control.</p>
	<p>The sound setup of the DVD disc may be not correct.</p>	<p>Setup the sound of the DVD correctly.</p>
	<p>The disc may be dirty or warped.</p>	<p>Clean or change the disc.</p>

Troubleshooting

PROBLEM	POSSIBLE CAUSE	POSSIBLE SOLUTION
There is no picture.	The LCD may be off or not be in correct video mode.	Turn on the LCD and choose the correct video mode.
	The system connection may be not correct.	Connect the system correctly.
	The unit may not be in DVD mode.	Switch the DVD/AV IN switch to DVD.
Poor AV performance.	The disc may be dirty or warped.	Clean or change the disc.

Other possibilities:

Static or other external interference may cause the player function abnormally. In order to recover normal status, unplug the power supply cord and then plug it into the outlet again to reset the player. If the problems still exist consult your service center or qualified technician.

Specifications

TFT screen size		8 inches
Laser Wavelength		780/650 nm
Video System		NTSC
Frequency Response		20Hz~20kHz ±2.5dB
Audio Signal-to-noise Rate		≥85dB
Audio distortion+noise		≤-70dB (1kHz)
Channel Separation		≥70dB (1kHz)
Dynamic Range		≥80dB (1kHz)
Audio Out	Analog Audio Out	Out Level: $1.5V_{\pm 1.0}^{0.2}$, Load: 10KΩ
Video Out	Video Out	Out Level: $1V_{p-p} \pm 0.1$, Load: 75Ω Unbalanced Negative
Power	AC 100-240V ~ 50/60Hz	
Power Consumption	< 25W	
Dimensions	195mmX149mmX38.5mm (L*W*D)	
Weight	About 1.2 kg	
Compliance with FCC, FDA - cUL listed E209155		

DESIGN AND SPECIFICATIONS ARE SUBJECT TO CHANGE WITHOUT NOTICE

Manufactured under license from Dolby Laboratories.
 "Dolby" and the double-D symbol are trademarks of Dolby Laboratories.
 Confidential unpublished works. © 1992 -1997 Dolby Laboratories.
 All rights reserved.

For service, support and warranty information, visit www.polaroidelectronics.com or in the US call 1-866-289-5168, in Canada call 1-866-301-7922 and in Mexico call 01-800-400-2443.

“Polaroid” is a registered trademark of Polaroid Corporation of Waltham, MA USA and licensed for use on the PDM-0817 to Petters Consumer Brands, LLC.

Portable DVD Player Docking Station ADS-1000

Operation Manual



20050324



Table of Contents

Important Safety Instruction -----	3
FCC Notice -----	5
Characteristic Features -----	6
Front View -----	7
Rear Panel & Side Panel -----	8
Display Panel -----	9
Remote Control -----	10
Attaching & Detaching Portable DVD player -----	13
System Connections -----	14
TV Function -----	17
AV Function -----	21
Troubleshooting -----	22
Specifications -----	23

Important Safety Instructions

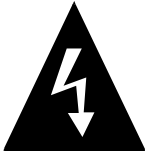

CAUTION
RISK OF ELECTRIC SHOCK
DO NOT OPEN!



CAUTION: TO REDUCE THE RISK OF ELECTRIC SHOCK, DO NOT REMOVE COVER (OR BACK). NO USE-SERVICEABLE PARTS INSIDE. REFER SERVICING TO QUALIFIED SERVICE PERSONNEL.



The lightning flash with arrowhead symbol, within an equilateral triangle, is intended to alert the user to the presence of uninsulated "dangerous voltage" within the product's enclosure that may be of sufficient magnitude to constitute a risk of electric to persons.



The exclamation point within an equilateral triangle is intended to alert the user to the presence of important operating and maintenance (servicing) instructions in the literature accompanying the appliance.

WARNING: TO REDUCE THE RISK OF FIRE OR ELECTRIC SHOCK, DO NOT EXPOSE THIS APPLIANCE TO RAIN OF MOISTURE.

POWER SUPPLY:

Connect the supplied adapter to the back of the Docking Station in the slot marked "DC 9.5V IN". Plug the two-prong end of the power cord to an AC100-240V outlet. If you have difficulty inserting the plug, turn it over and reinsert it, if the unit will not be used for a long time, disconnect the plug from the outlet.

NOTE:

Before plugging the power cord into an AC outlet, make sure that all the connections have been made.

CAUTION:

These servicing instructions are for use by qualified service personnel only. To reduce the risk of electric shock, do not perform any servicing other than that contained in the operating instructions unless you are qualified to do so.

Refer to service manual for servicing instructions.

Important Safety Instructions

Note:

1. Read these instructions.
2. Keep these instructions.
3. Heed all warnings.
4. Follow all instructions.
5. Do not use near water.
6. Clean only with dry cloth.
7. Do not block any ventilation openings. Maintain well ventilated conditions around the product. Do not put product on bed, sofa or anything that blocks ventilation. Install in accordance with the manufacturer's instructions.
8. Do not install near any heat sources such as radiators, heat regenerators, stoves, or other apparatus (including amplifiers) that produce heat.
9. Do not defeat the safety purpose of the polarized or grounding-type plug. A polarized plug has two blades with one wider than the other. A grounding type plug has two blades and a third grounding prong. The wide blade or the third prong is provided for your safety. If the provided plug does not fit into your outlet, consult an electrician for replacement of the obsolete outlet.
10. Protect the power cord from being walked on or pinched particularly at plugs, convenience receptacles, and the point where they exit from the apparatus.
11. Only use attachments/accessories specified by the manufacturer.
12. Use only with the cart, stand, tripod, bracket, or table specified by the manufacturer, or sold with the apparatus. When a cart is used, use caution when moving the cart/apparatus combination to avoid injury from tip-over.
13. Unplug this apparatus during lightning storms or when unused for long periods of time.
14. Refer all servicing to qualified service personnel. Servicing is required when the apparatus has been damaged in any way, such as power-supply cord or plug is damaged, liquid has been spilled or objects have fallen into the apparatus, the apparatus has been exposed to rain or moisture, does not operate normally, or has been dropped.
15. Apparatus shall not be exposed to dripping or splashing and no objects filled with liquids, such as vases, shall be placed on the apparatus.



FCC Notice

Note: This equipment has been tested and found to comply with the limits for a Class B digital device, pursuant to part 15 of the FCC Rules. These limits are designed to provide reasonable protection against harmful interference in a residential installation. This equipment generates, uses and can radiate radio frequency energy and, if not installed and used in accordance with the instructions, may cause harmful interference to radio communications. However, there is no guarantee that interference will not occur in a particular installation. If this equipment does cause harmful interference to radio or television reception, which can be determined by turning the equipment off and on, the user is encouraged to try to correct the interference by one or more of the following measures:

- Reorient or relocate the receiving antenna.
- Increase the separation between the equipment and receiver.
- Connect the equipment into an outlet on a circuit different from that to which the receiver is connected.
- Consult the dealer or an experienced radio/TV technician for help.

Characteristic Features

The Docking Station is designed for connecting to a compatible portable DVD player. It features an electrical connection interface that enables the portable DVD to effectively serve as a desktop DVD. It is integrated with connectors for peripheral devices to eliminate complicated connections and save valuable space around the unit. With the Docking Station, you can enjoy the expansion possibilities of desktop DVD with the portability of a portable DVD.

Multiple Mode

- DVD
- TV
- External Audio & Video mode

AV Input & AV Output

A/V input and output extend the connections for a portable DVD player.

Switching Power Adapter

Automatically adapts to the voltage required.

TV Functions

- Clear TV signal reception.
- Search for TV channels automatically.
- Automatically memorize the channels.

Clock Function

Displays the time even if in stand-by mode or if there is no DVD player attached. Timer will turn the docking station and attached DVD player on and off at desired times.

Front View

Front Panel Drawing

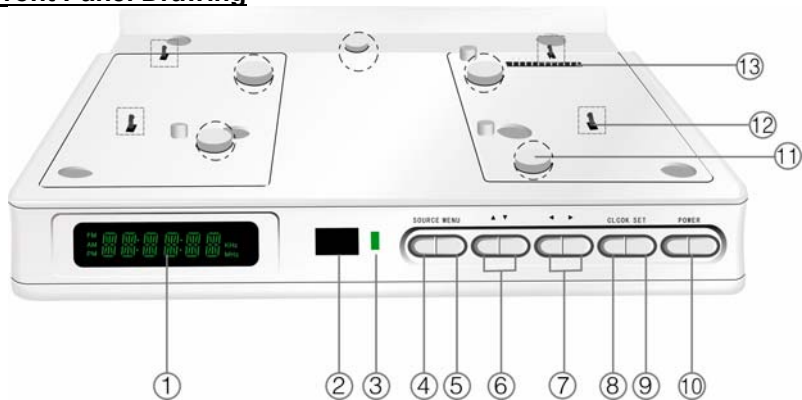

- 1. Display panel** Displays the time and status.
- 2. Remote Sensor** Receives remote control signal for operation.
- 3. Power Indicator**
- 4. SOURCE button** Press to shift among DVD, TV, AV1 and AV2 mode.
- 5. Menu:** Press to adjust the Picture standard, including Brightness, Contrast, Color, Language, or Reset all items.
- 6. ▲/▼ direction button** Press to select items in the setup menu. Press to select channels in TV mode. Press to adjust the value when setting the time on the display panel.
- 7. ◀/▶ direction buttons** Press to select items in the setup menu and to adjust the volume level. Press to adjust the value in the picture setup menu.
- 8. CLOCK button** Press once to display the time on the display panel. In standby status, the time is still displayed on the

- panel. Press it again to set the time on the display panel. Use the ◀ ▶ buttons to select the editing position of hour or minute, and then use the ▲ ▼ buttons to adjust the value of the hour or minute upward and downward.
- 9. SET button** Press to enter and exit from the timer setup menu. **In STANDBY mode, press this button to setup the alarm clock.**
 - 10. POWER button** Press to enter or exit the STANDBY mode.
 - 11. Spring Tab:** Used to spring the portable DVD player up when it is removed. (See page13)
 - 12. Fixing hooks:** Fix the portable DVD player on the Docking Station. (See page11)
 - 13. Docking jack:** For connection with a portable DVD player.

Rear Panel & Side Panel

Rear Panel Drawing

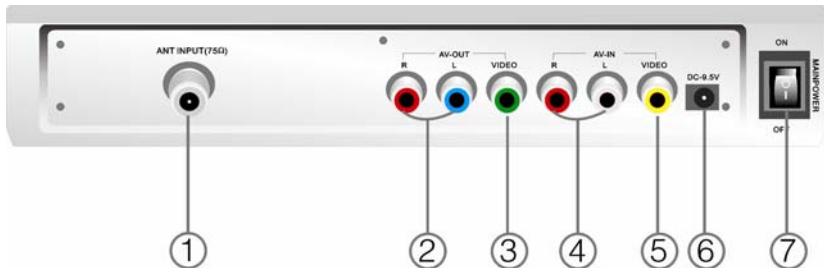

1. ANT INPUT jack

Connected to external antenna to receive the TV program in TV mode.

2. AUDIO OUT jack

Output the audio signal to external equipment, such as amplifiers, etc.

3. VIDEO OUT jack

Output the video signal to external equipment such as monitors, etc.

4. AUDIO IN jack

Connected to external audio signal source.

5. VIDEO input jack

Connected to external video signal source.

6. DC 9.5V input jack

Connected to the AC adapter.

7. Main Power Switch

Side Panel Drawing

Release buttons: Slide these buttons to release the portable DVD player from the Docking Station. (See page 13)

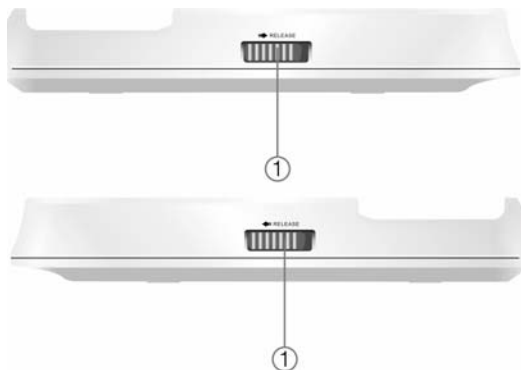

Display Panel

Display Panel Drawing

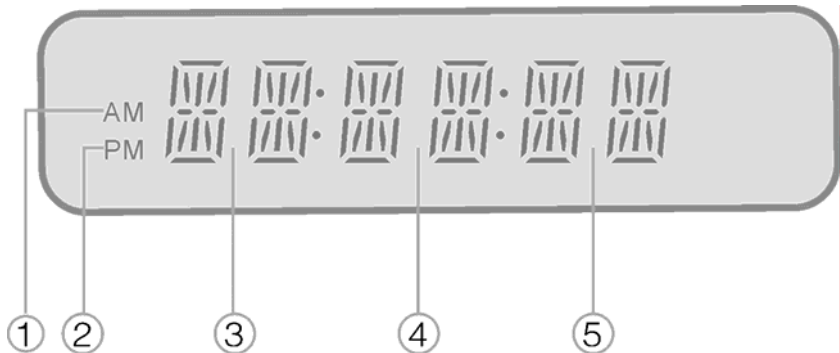

1. AM time indicator
2. PM time indicator
3. Hour or character indicators
4. Minute or character indicators
5. Character indicators

Remote Control

Preparation

Refer to the drawing and remove the empty battery receptacle.

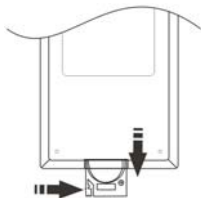

Insert the battery into the receptacle. Make sure the polarity matches the marks inside the component.

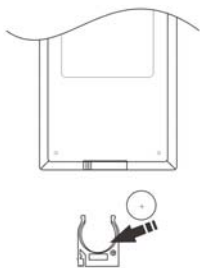

Insert the receptacle into the remote control.

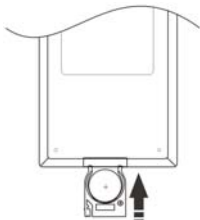

Using Of Remote Control

Point the remote control towards the main unit when operating. The remote control works best at a distance less than 7m and at an angle of up to 60° to the front of the unit. No obstacles may stand in the way between remote control and infrared sensor.



The batteries normally last for about six months. This depends on how often and for what operations the remote control is used.

If the remote control unit fails to work even when it is operated near the player, replace the battery.

If the remote control is not used for a long period of time, remove the battery from the compartment, to prevent damage by leakage.

Remote Control

Remote Control Drawing

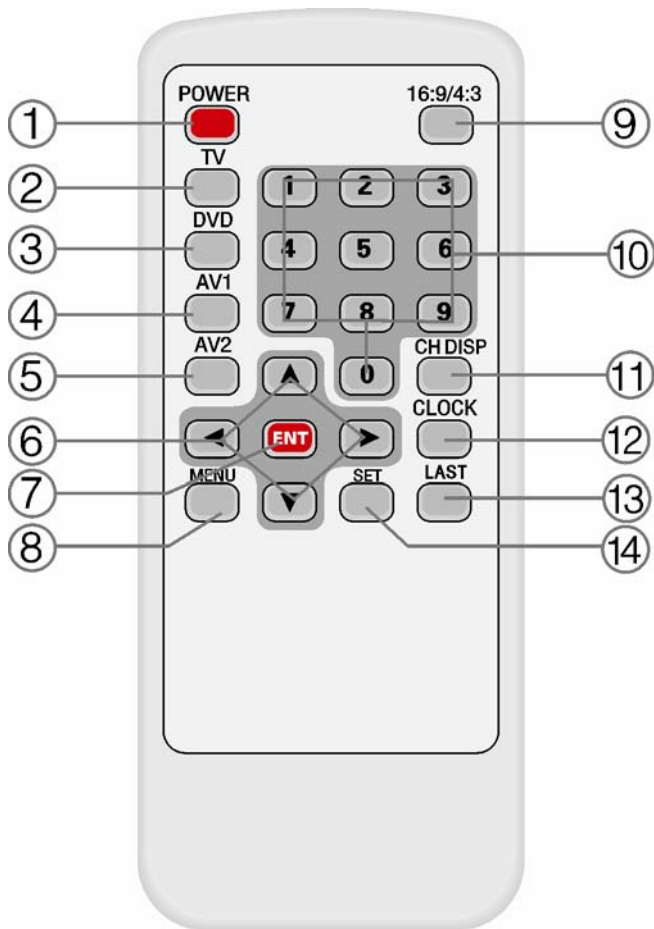

Remote Control

1. **POWER button**
Press to access to or exit the STANDBY mode.
2. **TV button**
Press to enter TV mode.
3. **DVD button**
Press to enter DVD mode.
4. **AV1 button**
Press to shift to external AV1 input mode.
5. **AV2 button**
Press to shift to external AV2 input mode.
6. **◀ ▶ ▲ ▼**
Press to select menu items or settings. Press ◀ ▶ buttons to adjust volume. Or press to adjust value in the picture setup menu. Press ▲ ▼ buttons to select channels forward and backward in TV mode. Or press to adjust the value of time when setting time on the display panel.
7. **ENT button**
Press to confirm selections.
8. **MENU button**
Press to access the menu of current mode.
9. **16:9/4:3 button**
Press to shift the aspect ratio between 16:9 and 4:3.
10. **0-9 number buttons**
Select numbers by pressing these buttons.
One-digit number: press the number button and press the ENT button or wait 2 seconds to confirm.
Two-digit number: press the first number and input the second number in 2 seconds.
Three-digit number: press the first number, then input the second number in 2 seconds, and input the third number in the next 2 seconds.
11. **CH DISP**
In TV mode, display the current channel information.
12. **CLOCK button**
Press once to display the time on the display panel. In standby status, the time is still displayed on the display panel. Press twice to set the time on the display panel. Use the ◀ ▶ buttons to select the editing position of hour or minute, use the ▲ ▼ buttons to adjust the value of the hour or minute upward and downward.
13. **LAST button**
Press to back the last channel that you watch in TV mode.
14. **SET button**
Press to enter and exit from the timer setup menu. In STANDBY mode, press this button to setup the alarm clock.

Attaching & Detaching Portable DVD player

Note: Do not connect the power cord until all other connections have been made.

Attaching Portable DVD player to Docking Station

Follow the steps below to attach the portable DVD player to the Docking Station. It is advised to attach the rechargeable battery to the portable DVD player before this connection.

Step1: Center the player on the Docking Station and line up the 4 slots on the bottom of the player with the 4 fixing hooks on the Docking Station.

Step2: Press the portable DVD player down gently with two hands and the fixing hooks will fix the portable DVD player on the Docking station from moving.

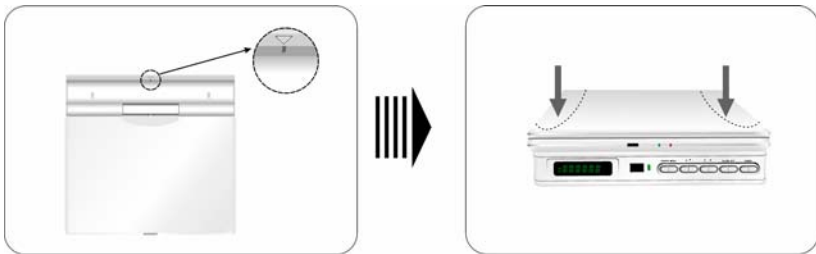

Detaching Portable DVD player from Docking Station

Step1: Slide the two release buttons toward the front of the Docking Station to unlock the fixing hooks. The five spring tabs will spring the portable DVD player up.

Step2: Remove the portable DVD player from Docking Station.

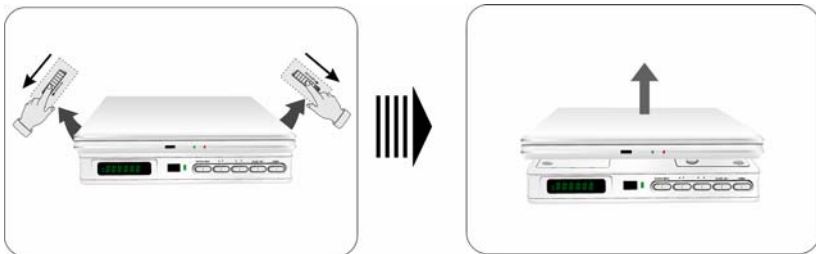

System Connections

- Do not connect the power cord until all other connections have been made.
- Ensure that you observe the color cord when connecting audio and video cables.

Expand the Connections

The following drawing shows a sample of expanding the connections of a portable DVD player with Docking Station:

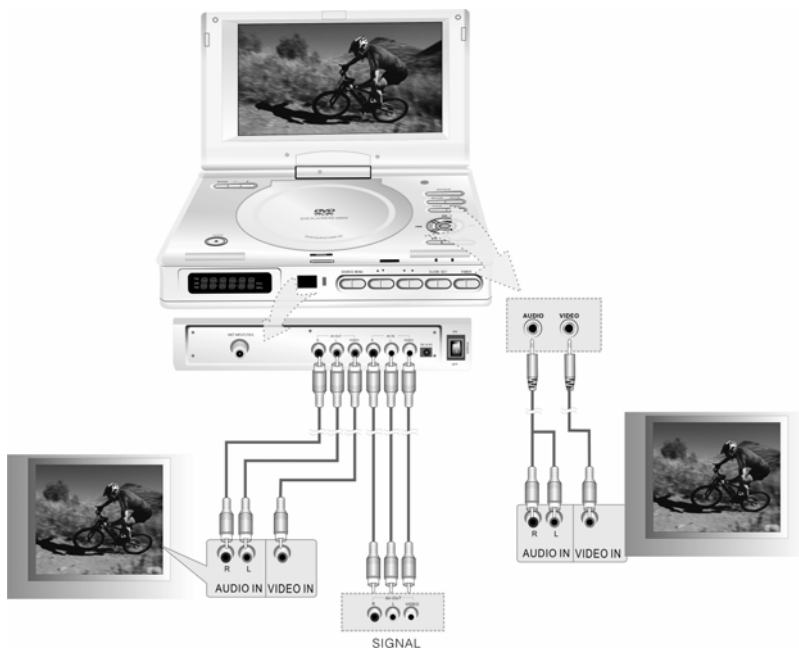

After connecting with external AV source by AV jacks, please turn on the power of the unit and press the SOURCE button on the front panel to shift to AV1 mode, or, press the AV1 button on the remote control to shift the mode directly.

If the AV source from docking station, please press the SOURCE button on the front panel to shift to AV2 mode, or, press the AV2 button on the remote control to shift the mode directly.

System Connections

Connecting To TV Signal Input Source

The unit can be connected to a TV antenna to receive TV programs.

Connections should be made as follows:



After connecting the antenna, turn on the power of the Docking Station; press the SOURCE button on the front panel or the TV button on the remote control to switch to TV mode.

System Connections

Connecting To the Power Adapter

This unit is powered via the switching power adapter (supplied) :

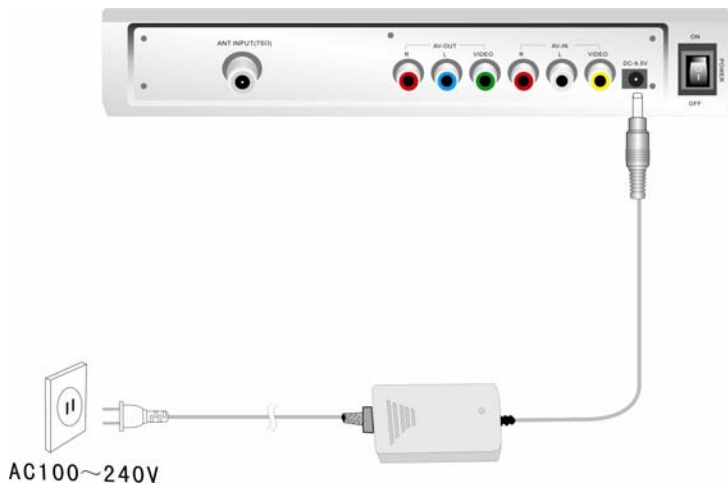

1. Connect the AC adapter to jack marked with "DC 9.5V IN" on the rear panel of the unit.
2. Plug the two-prong end of the power cord to the grounded electrical socket.
3. When not using the unit, turn off the power of the unit first, and then unplug the power supply to prevent malfunctions.

TV Function

Basic Operation

Connect the antenna to the antenna jack on the rear panel. After connecting the antenna, connect the power supply cord. If the player is in standby mode, press the POWER button on the front panel to turn on the power.

Press the TV button on the remote control to shift to TV mode.

Press the ▲ ▼ buttons on the remote control to select the desired channel, or press the number buttons to select your desired channel. (See page 12)

Some preferences can be preset:

Picture Parameter Setup

Press the MENU button once on the remote control to enter PICTURE setup menu, and screen display as shown:

PICTURE	
BRIGHTNESS	10
CONTRAST	10
COLOR	10
LANGUAGE	ENGLISH
RESET	
◀ EXIT	TV SETUP ▶

Use the ▼、▲ buttons to select the item you want to set (Brightness, Contrast, Color).

Use the ▶, ◀ buttons to adjust, you can adjust the items between 0 and 20.

Use the ▼, ▲ buttons to select the Language, press the ▶, ◀ buttons to select English, French or Spanish.

To restore a setting to the original value, use the ▼、▲ buttons to select Reset, then press the ENT button to confirm the change.

Press the ◀ button on the remote control to exit the setup menu.

Press the ▶ button on the remote control to enter TV Setup menu.

TV System Setup

When the ▶ button is pressed, the TV system setup menu will appear:

TV SETUP	
SIGNAL	CATV
CHANNEL	002
SKIP	ON
BLUE SCREEN	OFF
FINE TUNING	
AUTO MEMORY	
◀ PICTURE	EXIT ▶

TV Function

Use the ▼, ▲ buttons to select the item you want to set.

Use the ►, ◀ buttons to select the item and enter it.

Press the ► button on the remote control to exit the setup menu.

Press the ◀ button on the remote control to return to the picture setup menu.

Signal

Use the ► direction button to select CATV TV signal input mode.

Use the ◀ direction button to select ANT TV signal input mode.

Channel

Use the ►, ◀ buttons to change the channel. In CATV input mode, you can select channels from 2 to 125; in ANT input mode, you can select channels from 2 to 69.

Blue Screen

This function is only available in no signal input mode.

Use the ► button to turn the function ON, use the ◀ button to turn the function OFF.

Skip

When the ► button is pressed to turn the function ON, it will skip the current channel

Press ▼, ▲ to select channels.

When the ◀ button is used to turn the function OFF, it will play the channels in sequence when selecting under normal playback status.

Fine Tuning

Use the ▼, ▲ buttons to select Fine Tuning, and then press the ►, ◀ buttons to tune forward or backward from the current channel

TV Function

Auto Memory

Use the ▼、▲ buttons to select Auto Memory, press the ENT button to enter auto memory mode:

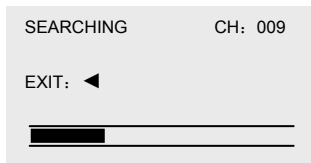

The auto memory will take a few minutes. The unit will search channels from the lowest channel to the highest channel in the standard channel list. When tuning operations are complete the unit will exit and store the channels by sequence in the memory.

During tuning, press the ◀ button to exit the auto memory.

Use the ▼、▲ direction buttons to select the desired channel from those in memory.

Timer Setup

Press the SET button on the remote control to enter Timer setup menu, the screen will display as below:

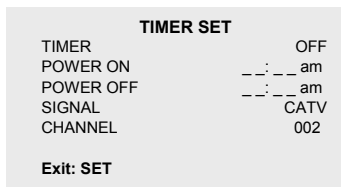

Use the ▼、▲ buttons to select the item you want to set.

Use the ▶、◀ buttons to enter the item and to select.

Press the SET button again on the remote control to exit the setup menu.

Timer

Use the ▶、◀ direction buttons to select ON or OFF. This function allows you to set the start time and end time of the desired signal source. No matter what mode the unit is in, it will automatically start the playback of the desired signal source.

Select ON to activate the function; select OFF to disable the function.

TV Function

Power on

To set the playback start time of the signal source, use number buttons to input the desired start time in sequence of hour, minute. Press the ►, ◀ direction buttons to shift between am and pm.

Power off

To set the playback end time of the signal source, use number buttons to input the desired time in sequence of hour, minute. Press the ►, ◀ direction buttons to shift between am and pm. When the playback of the signal source is over, the player will enter standby mode.

Signal

Use the ►, ◀ direction buttons to select CATV, ANT.

Channel

Use number buttons to input the desired TV channels. In CATV signal input mode, there are 124 channels to choose from (2-125); in ANT signal input mode, there are 68 channels to choose from (2-69).

Note:

The function is active as long as the unit is continuously supplied with power. The unit will automatically play the selected input signal at the set start time and enter standby mode at the set end time each day.

AV Function

AV Function

The docking station has an additional AV input and output. When an AV source is connected, press the AV1 or AV2 button on the remote control to enter external AV mode.

Picture Parameter Setup

Press the MENU button once on remote control to enter PICTURE setup menu, and screen will display as shown:

PICTURE	
BRIGHTNESS	10
CONTRAST	10
COLOR	10
LANGUAGE	ENGLISH
RESET	
◀ Exit	

Use the ▼, ▲ buttons to select the item you want to set (Brightness, Contrast, Color).

Use the ►, ◀ buttons to adjust the items between 0 and 20.

Use the ▼, ▲ buttons to select the Language, press the ►, ◀ buttons to select English, French or Spanish.

Select Reset to return to the factory default settings.

Press the ◀ button on the remote control to exit the setup menu.

Note:

Under AV mode, if there is no signal, the LCD screen will be turned off automatically.

When connected to an AV signal source, make sure the type of the selected AV signal source is NTSC.

Troubleshooting

SYMPTOM	CHECK ITEM
The attached portable DVD player does not work.	<ul style="list-style-type: none">● Make sure the Docking Station power is on.● Make sure the portable DVD player is properly connected with the Docking Station. If not, attach the DVD player again. (See page13).● Make sure the SOURCE mode has been switched to the DVD mode.
There is no TV function.	<ul style="list-style-type: none">● Make sure the SOURCE mode has been switched to the TV mode.● Make sure the portable DVD player is properly connected with the Docking Station. If not, attach the DVD player again. (See page 13)● Make sure the TV cable is firmly connected with the Docking Station.● Make sure the TV channels have been programmed with the Auto Memory. (See page19)
There is no picture or picture is unsteady.	<ul style="list-style-type: none">● Make sure the video type of the AV signal source is NTSC.● Make sure system connection is correct..
The remote control does not work.	<ul style="list-style-type: none">● Make sure there are no obstructions between the remote control and the player.● Make sure the remote control is pointing at the Docking Station's remote receiver.● Make sure battery is inserted correctly.● Replace weak battery

Specifications

This unit is compatible with all PDM series players with Docking Jack.

Power	AC100V~ 240V, 50/60Hz
TV Type	NTSC
Power Consumption	≤30W
Dimension	230mm X 208mm x 46mm (W/H/D)
Weight	About 0.75 kg

DESIGN AND SPECIFICATIONS ARE SUBJECT TO CHANGE WITHOUT NOTICE

For service, support and warranty information, visit www.polaroidelectronics.com or in the US call 1-866-289-5168, in Canada call 1-866-301-7922 and in Mexico call 01-800-400-2443.

“Polaroid” is a registered trademark of Polaroid Corporation of Waltham, MA USA and licensed for use on the ADS-1000 to Petters Consumer Brands, LLC.

Free Manuals Download Website

<http://myh66.com>

<http://usermanuals.us>

<http://www.somanuals.com>

<http://www.4manuals.cc>

<http://www.manual-lib.com>

<http://www.404manual.com>

<http://www.luxmanual.com>

<http://aubethermostatmanual.com>

Golf course search by state

<http://golfingnear.com>

Email search by domain

<http://emailbydomain.com>

Auto manuals search

<http://auto.somanuals.com>

TV manuals search

<http://tv.somanuals.com>