



CCD Camera
GiantDragon B/W series
CSGV90BC3
CSGX36BC3
CSGS20BC2
CSGU15BC18
CSGS15BC23

Instruction Manual

Thank you for purchasing our product.
Before using this CCD Color Camera, please read through this instruction manual carefully in order to use this product correctly and safely.
After reading, keep this instruction manual handy so that you can refer to, whenever you need it.

Contents

Safety Precautions

1. Overview	1
2. Features	1
3. Configuration	2
4. Optional part	2
5. Explanation rear panel	3
6. Connection	4
7. Functions	5
8. Timing chart	8
9. Troubleshooting	10
10. Specifications	11
11. Outline Drawing	17

TOSHIBA TELI CORPORATION

Printed on recycled paper



D4153659A

Safety Precautions

Before using this product, read these safety precautions carefully. Important information is shown in this Instruction Manual to protect users from bodily injuries and property damages, and to enable them to use the product safely and correctly.

Please be sure to thoroughly understand the meanings of the following signs and symbols before reading the main text that follow, and observe the instructions given herein.

[Definition of Safety Signs]



Safety Signs	Description
 WARNING	Indicates a potentially hazardous situation that may result in death or serious injury (*1) in the event of improper handling.
 CAUTION	Indicates a potentially hazardous situation that may result in light to moderate injuries (*2) or only in property damage (*3) in the event of improper handling.

Notes *1: "Serious injury" refers to cases of loss of eyesight, wounds, burns (high or low temperature), electric shock, broken bones, poisoning, etc., which leave after-effects or which require hospitalization or a long period of outpatient treatment of cure.

*2: "Light to moderate injuries" refers to injuries, burns, electric shock etc. that do not require hospitalization or long-term treatment.

*3: "Property damage" refers to cases of extensive damage involving damage to buildings, equipment, farm animals, pet animals and other belongings.

[Explanation of Safety Symbols]

Safety Symbols	Description
 PROHIBITED	This sign indicates PROHIBITION (Do not). The content of prohibition is shown by a picture or words beside the symbol.
 MANDATORY	This sign indicates MANDATORY ACTION (You are required to do). The content of action is shown by a picture or words beside the symbol.

[General Handling]

WARNING



Unplug

- **Stop operation immediately when any abnormality or defect occurs.**

If abnormal conditions are present, such as smoke, a burning smell, ingress of water or foreign matter, or if the equipment is dropped or malfunctions, fire or electric shock may result. Be always sure to disconnect the power cable from the wall socket at once and contact your dealer.



Do not get wet

- **Do not use the equipment in locations subject to water splashes.**

Otherwise, fire or electric shock may result.



Never pull apart

- **Do not disassemble, repair, or modify the equipment.**

Otherwise, fire or electric shock may result.

For internal repair, inspection, or cleaning, contact your sales representative.



Avoid

- **Do not place anything on the equipment.**

If metallic objects, liquid, or other foreign matter enters the equipment, fire or electric shock may result.



Avoid

- **Do not install the equipment in an unstable or inclined location or locations subject to vibration or impact.**

Otherwise, the equipment may topple over and cause personal injury.



Do not touch

- **During an electrical storm, do not touch the power cable and the connection cable.**

Otherwise, an electric shock may result.



Instruction

- **Use the specified voltage.**

Use of an unspecified voltage may result in fire or electric shock.



Avoid

- **Do not be handled roughly, damaged, fabricated, bent forcefully, pulled, twisted, bundled, placed under heavy objects or heated the power cable and the connection cable.**

Otherwise, fire or electric shock may result.

[General Handling]

CAUTION



Instruction

- **Observe the following when installing the equipment:**

- Do not cover the equipment with a cloth, etc.
- Do not place the equipment in a narrow location where heat is likely to accumulate. Otherwise, heat will accumulate inside the equipment, possibly resulting in a fire.



Avoid

- **Do not place the equipment in locations subject to high moisture, oil fumes, steam, or dust.**

Otherwise, fire or electric shock may result.



Avoid

- **Do not install the equipment in locations exposed to direct sunlight or humidity.**

Otherwise, the internal temperature of the equipment will rise, which may cause a fire.



Instruction

- **Use only specified the power cable and the connection cables.**

Otherwise, fire or electric shock may result.



Instruction

- **When performing connection, turn off power.**

When connecting the power cable and the connection cable, turn off the equipment power. Otherwise, fire or electric shock may result.



Avoid

- **Do not expose its camera head to any intensive light (such as direct sunlight).**

Otherwise, its inner image pickup device might get damaged.



Avoid

- **Avoid short-circuiting signal output.**

Otherwise, a malfunction may occur.



Avoid

- **Avoid giving a strong shock against the camera body.**

It might cause a breakdown or damage. If your camera is used in a system where its camera connector is subjected to strong repetitive shocks, its camera connector is possible to break down. If you intend to use your camera in such a situation, if possible, bundle and fix a camera cable in the place near the camera, and do not transmit a shock to the camera connector.



Instruction

- **Contact your sales representative to request periodic inspection and cleaning (every approx five years).**

Accumulation of dust inside the equipment may result in fire or electric shock. For inspection and cleaning costs, contact your sales representative.

CASES FOR INDEMNITY (LIMITED WARRANTY)

We shall be exempted from taking responsibility and held harmless for damage or losses incurred by the user in the following cases.

- In the case damage or losses are caused by fire, earthquake, or other acts of God, acts by a third party, deliberate or accidental misuse by the user, or use under extreme operating conditions.
 - In the case of indirect, additional, consequential damages (loss of business interests, suspension of business activities) are incurred as result of malfunction or non-function of the equipment, we shall be exempted from responsibility for such damages.
 - In the case damage or losses are caused by failure to observe the information contained in the instructions in this instruction manual and specifications.
 - In the case damage or losses are caused by use contrary to the instructions in this instruction manual and specifications.
 - In the case damage or losses are caused by malfunction or other problems resulting from use of equipment (connected equipments including Gigabit Ethernet Interface board, the lens, etc.) or software that is not specified.
 - In the case damage or losses are caused by repair or modification conducted by the customer or any unauthorized third party (such as an unauthorized service representative).
 - Expenses we bear on this product shall be limited to the individual price of the product.
-

RESTRICTION FOR USE

- Should the equipment be used in the following conditions or environments, give consideration to safety measures and inform us of such usage:
 1. Use of the equipment in the conditions or environment contrary to those specified, or use outdoors.
 2. Use of the equipment in applications expected to cause potential hazard to people or property, which require special safety measures to be adopted.
 - This product can be used under diverse operating conditions. Determination of applicability of equipment or devices concerned shall be determined after analysis or testing as necessary by the designer of such equipment or devices, or personnel related to the specifications. Such designer or personnel shall assure the performance and safety of the equipment or devices.
 - This product is not designed or manufactured to be used for control of equipment directly concerned with human life (*1) or equipment relating to maintenance of public services/functions involving factors of safety (*2). Therefore, the product shall not be used for such applications.
 - (*1): Equipment directly concerned with human life refers to.
 - Medical equipment such as life-support systems, equipment for operating theaters.
 - Exhaust control equipment for exhaust gases such as toxic fumes or smoke.
 - Equipment mandatory to be installed by various laws and regulations such as the Fire Act or Building Standard Law
 - Equipment related to the above
 - (*2) :Equipment relating to maintenance of public services/functions involving factors of safety refers to.
 - Traffic control systems for air transportation, railways, roads, or marine transportation
 - Equipment for nuclear power generation
 - Equipment related to the above
-

Notes on using this product

- **Handle carefully**

Do not drop the equipment or allow it to be subject to strong impact or vibration, as such action may cause malfunctions. Further, do not damage the connection cable, since this may cause wire breakage.

- **Environmental operating conditions**

Do not use the product in locations where the ambient temperature or humidity exceeds the specifications. Otherwise, image quality may be degraded or internal components may be adversely affected. In particular, do not use the product in areas exposed to direct sunlight. Moreover, during shooting under high temperatures, vertical stripes or white spots (noise) may be produced, depending on the subject or camera conditions (such as increased gain). However, such phenomena are not malfunctions.

- **Check a combination with the lens**

Depending on the lens and lighting you use, an image is reflected as a ghost in the imaging area. However, this is not because of a fault of the camera.

In addition, depending on the lens you use, the performance of the camera may not be brought out fully due to deterioration in resolution and brightness in the peripheral area, aberration and others.

Be sure to check a combination with the camera by using the lens and lightning you actually use.

When installing a lens in the camera, make sure carefully that it is not tilted.

In addition, use a mounting screw free from defects and dirt. Otherwise, the camera may be unable to be removed.

- **Do not shoot under intense light**

Avoid intense light such as spot lights on part of the screen because it may cause blooming or smears. If intense light falls on the screen, vertical stripes may appear on the screen, but this is not a malfunction.

- **Occurrence of moiré**

If you shoot thin stripe patterns, moiré patterns (interference fringes) may appear. This is not a malfunction.

- **Occurrence of noise on the screen**

If an intense magnetic or electromagnetic field is generated near the camera or connection cable, noise may be generated on the screen. If this occurs, move the camera or the cable.

- **Handling of the protective cap**

If the camera is not in use, attach the lens cap to the camera to protect the image pickup surface.

- **If the equipment is not to be used for a long duration**

Turn off power to the camera for safety.

- **Maintenance**

Turn off power to the equipment and wipe it with a dry cloth.

If it becomes severely contaminated, gently wipe the affected areas with a soft cloth dampened with diluted neutral detergent. Never use alcohol, benzene, thinner, or other chemicals because such chemicals may damage or discolor the paint and indications.

If the image pickup surface becomes dusty, contaminated, or scratched, consult your sales representative.

- **Disposal**

When disposing of the camera, it may be necessary to disassemble it into separate parts, in accordance with the laws and regulations of your country and/or municipality concerning environmental contamination.

Following information is only for EU-member states:

The use of the symbol indicates that this product may not be treated as household waste. By ensuring this product is disposed of correctly, you will help prevent potential negative consequences for the environment and human health, which could otherwise be caused by inappropriate waste handling of this product. For more detailed information about the take-back and recycling of this product, please contact your supplier where you purchased the product.



This equipment has been tested and found to comply with the limits for a class A digital device, pursuant to Part 15 of the FCC Rules.

These limits are designed to provide reasonable protection against harmful interference when the equipment is operated in a commercial environment.

This equipment generates, uses, and can radiate radio frequency energy and, if not installed and used in accordance with the instruction manual, may cause harmful interference to radio communication.

Operation of this equipment in a residential area is likely to cause harmful interference in which case the user will be required to correct the interference at his own expense.

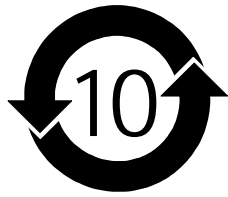

中华人民共和国
环保使用期限

环保使用期限标识，是根据电子信息产品污染控制管理办法以及，电子信息产品污染控制标识要求(SJ/T11364-2006)、电子信息产品环保使用期限通则，制定的适用于中国境内销售的电子信息产品的标识。

电子信息产品只要按照安全及使用说明内容，正常使用情况下，从生产月期算起，在此期限内，产品中含有的有毒有害物质不致发生外泄或突变，不致对环境造成严重污染或对其人身、财产造成严重损害。

产品正常使用后，要废弃在环保使用年限内或者刚到年限的产品时，请根据国家标准采取适当的方法进行处置。

另外，此期限不同于质量/功能的保证期限。

The Mark and Information are applicable for People's Republic of China only.

<产品中有毒有害物质或元素的名称及含量>

部件名称	有毒有害物质或元素					
	铅 (Pb)	汞 (Hg)	镉 (Cd)	六价铬 (Cr(VI))	多溴联苯 (PBB)	多溴二苯醚 (PBDE)
相机本体	×	○	○	○	○	○

○: 表示该有毒有害物质在该部件所有均质材料中的含量均在电子信息产品中有毒有害物质的限量要求标准规定的限量要求(SJ/T11363-2006)以下



×: 表示该有毒有害物质至少在该部件的某一均质材料中的含量超出电子信息产品中有毒有害物质的限量要求标准规定的限量要求(SJ/T11363-2006)

This information is applicable for People's Republic of China only.

リサイクルに関する情報(包装物)

有关再利用的信息(包装物)

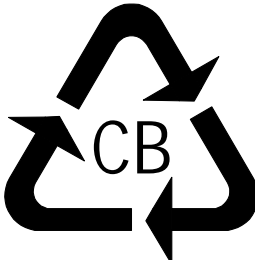
Information on recycling of wrapping composition

<p>箱／箱子／Box</p>  <p>段ボール 瓦楞纸板 Corrugated cardboard</p>	<p>内部緩衝材料 内部缓冲材料 Internal buffer materials</p>  <p>OTHERS</p>
---	---

1. Overview

This GiantDragon B/W series is an integrated-(one-body)-type monochrome camera that adopts all pixel data readout inter line CCD. There are 4 models according to the sensor type. These are CSGV90BC3 (VGA), CSGX36BC3 (XGA), CS GS20BC2 (SXGA: 1/2 type), CS GU15BC18 (UXGA), and CS GS15BC23 (SXGA: 2/3 type). For video output, the Gigabit Ethernet[®]* interface standard “IEEE802.3ab” is adopted for high transfer rate, and it is easy to integrate into industrial equipment.

* Ethernet[®] is a registered trademark of XEROX Corporation.

2. Features

● **High frame rate and high resolution**

Supported high frame rate CSGV90BC3 (90fps/VGA), CS GX36BC3 (36fps/XGA), CS GS20BC2 (20fps/SXGA: 1/2 type), CS GU15BC18 (15fps/UXGA), and CS GS15BC23 (15fps/SXGA: 2/3 type).

● **All pixel readout**

All pixel signals (in the effective area) are output in one frame processing.

● **Full frame shutter**

Since all pixels are output even by shutter operation, high resolution can be achieved, without deteriorating the vertical resolution.

● **Square grids**

The CCD pixels arrayed in square grids facilitates computation for image processing.

● **Gigabit Ethernet interface**

Performs video output and camera control via the Gigabit Ethernet standard IEEE802.3ab interface. Data transfer is at 1Gbps that can output uncompressed video data of high frame rate.

● **GigEVision Ver 1.0 conformity**

This product is based on GigEVision Camera Interface Standard for Machine Vision Ver 1.0 that is industrial camera standard. Therefore, control of this camera is easy.

● **GenICam Ver 1.0 conformity**

This product is based on GenICam Generic Interface for Cameras Ver 1.0 that is industrial camera standard. Therefore, control of this camera is easy.

● **Binning mode**

This mode realizes high-speed frame rate by adding two vertical lines or four vertical lines.

● **Random trigger shutter**

The random trigger shutter function provides images in any timing by input of an external trigger signal. Trigger control from PC is possible.

● **Scalable**

Selectable video output area. It can be higher frame rate by reducing vertical output area. And can be reduce occupied data rate of Gigabit Ethernet by reducing horizontal output area.

● **Compact and lightweight**

This camera is compact and lightweight, and it is easy to integrate into industrial equipment.

● **EU RoHS & Chinese ROHS compliant**

3. Configuration

- (1) Camera body 1
- (2) Accessories
 - Instruction Manual (Japanese) 1
 - Instruction Manual (English) 1
 - * No application software is attached to this camera.

4. Optional part

- (1) Camera mounting kit..... Model name: CPT8420
- (2) Camera cable..... Model name: CPRC3910-**
- (3) Camera adapter..... Model name: CA130C
- * Contact your dealer / distributor for details of option units.

5. Explanation rear panel

(1) Ethernet

- Connector model
- Pin assignment

Pin No.	I/O	Function
1	I/O	BI_DA+
2	I/O	BI_DA-
3	I/O	BI_DB+
4	I/O	BI_DC+
5	I/O	BI_DC-
6	I/O	BI_DB-
7	I/O	BI_DD+
8	I/O	BI_DD-

Gigabit Ethernet Interface connector

P65-P01-19V8 (Supplied by SpeedTech Corp.)

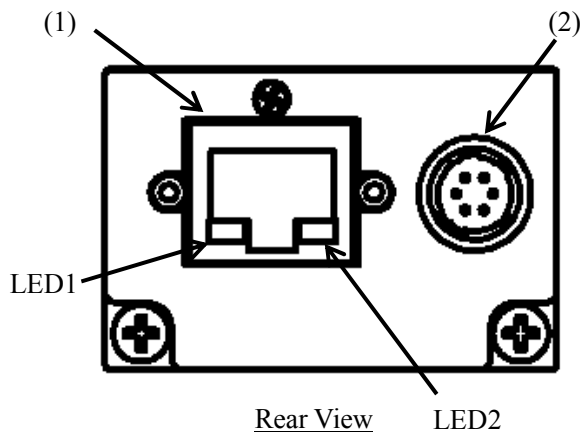

- Indication LED1: GREEN (ACT LED)

During transfer:

LED1 indicates the state of ACT.

Lighting

- Indication LED2: YELLOW (LINK LED)

During Link:

LED2 indicates the state of LINK.

Lighting

* LINK LED indicates establishment of Link of 1000BASE. Therefore, in the case of 100BASE/10BASE, LINK LED does not light.

(2) DC_IN / TRIGGER

- Connector (Camera side)

HR10A-7R-6PB(73)

(Supplied by HIROSE ELECTRIC CO., LTD.)

- Plug (Cable side)

HR10A-7P-6S(73)

(Supplied by HIROSE ELECTRIC CO., LTD.)

or equivalents

* This camera cable is not an accessory of this product.

- Pin assignment

Pin No.	Signal Name [Standard specification]
1	BUSY_OUT
2	GND
3	GND
4	TRIG_IN
5	EXPOSE_OUT
6	+12V

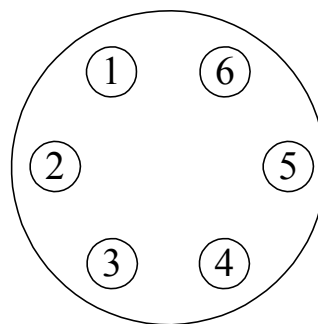

*Above figure is connector view from insert side.

6. Connection

Connect this camera as shown in the figure below.

(The figure below shows an example of connection. For details, contact our sales representative.)

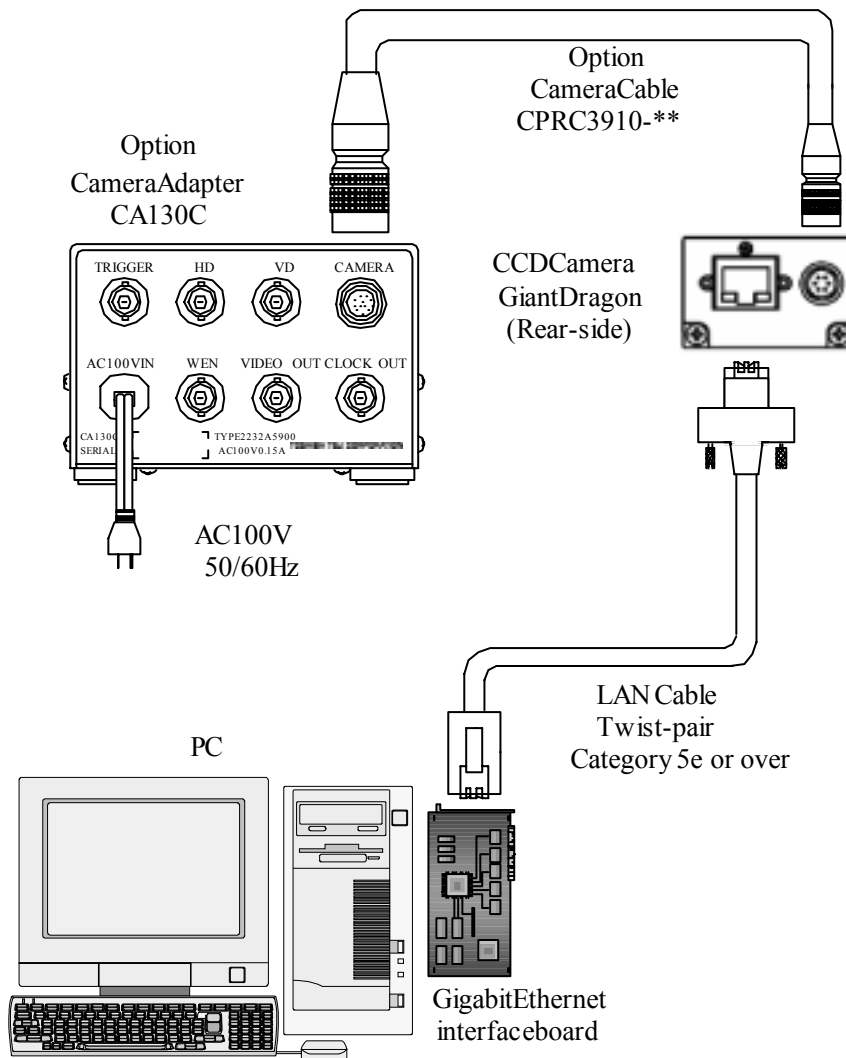

Notes on Connection:

- If your camera is used in a system where its connectors are subjected to strong repetitive shocks, its connectors are possible to break down. If you use your camera in such a situation, use an LAN cable with a lock screw, and secure the camera cable as close as possible to the camera body for avoid physical shock to the camera connector.
- Since the Optional parts and Gigabit Ethernet interface board, cable not attached to this product, please prepare it if necessary.

7. Functions

Control and setting of functions can be done by the camera control based on the Gigabit Ethernet digital camera protocol (GigEVision Ver.1.00).

(1) Image output

A format of the output image and frame rate which this GiantDragon B/W series supports is as follows.

Model	CSGV90BC3	CSGX36BC3	CSGS20BC2	CSGU15BC18	CSGS15BC23
Image output format	GVSP_PIX_MONO8: Mono 8 bit				
	GVSP_PIX_MONO10: Mono 10 bit				
Frame rate (at the all pixel readout)	Maximum 90fps	Maximum 36fps	Maximum 20fps	Maximum 15fps	Maximum 15fps

Notes on Frame Drops of Image:

- Depends on your PC or Gigabit Ethernet interface board configurations, images may not be captured normally (e.g. frame drops may occur). In this case, change to frame rate setting lower.

(2) Setup-level setting

You can set the Setup-level in 192 steps in the range between 6.3 and 25%.

(3) Gain setting

When shipping it, the gain is set to 0dB. You can set the gain in 91 steps in the range between 0 and +12dB.

(4) Binning mode

This mode realizes high-speed frame rate by adding two vertical lines or four vertical lines.

	CSGV90BC3	CSGX36BC3	CSGS20BC2	CSGU15BC18	CSGS15BC23
Binning mode	1/2	1/2	1/2	1/4	1/2
Readout vertical line number	240	384	480	300	512
Maximum frame rate	170fps	64 fps	34fps	46fps	32fps

(5) Image resending control

As the resending control of the image, this camera resends the packet which suffered a loss.

(7) Scalable mode

This camera has the scalable mode that can read out defined area of the screen. Only continuous rectangle units can be selected, concave or convex shape cannot be selected.

- Window size: $\{A \times m(H)\} \times \{B \times n(V)\}$

* A and B are minimum unit size.

* m, n=integer

* The image of maximum unit size or less can be selected.

* Only one window can be selected.

	CSGV90BC3	CSGX36BC3	CSGS20BC2	CSGU15BC18	CSGS15BC23
Minimum unit size (H) x (V)	160 x 120	256 x 192	160 x 120	200 x 150	170 x 128
Maximum unit size (H) x (V)	640 x 480	1024 x 768	1280 x 960	1600 x 1200	1360 x 1024

- Start address: $\{32 \times i(H)\} \times \{24 \times j(V)\}$

* i, j=integer

* The image of maximum unit size or less can be selected.

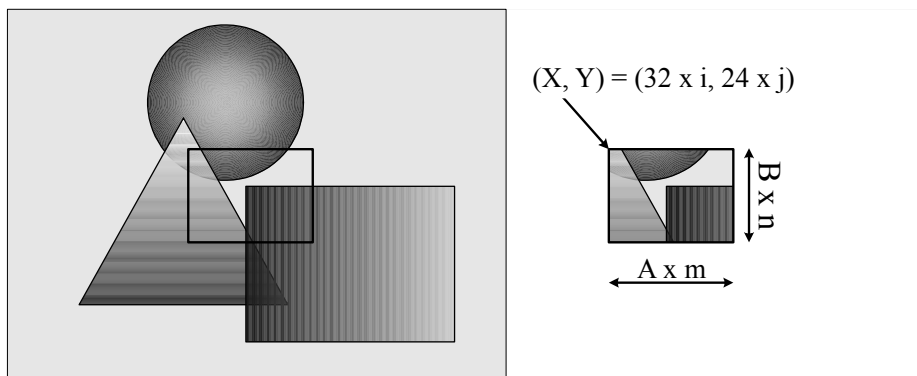

In the scalable mode, this camera reads out only the necessary portions at the standard speed while it scans through other unnecessary portions at high speed, so the trigger interval can be shorter if the vertical cutout width is small. However, the trigger interval cannot be short in the horizontal direction even if the cutout width is small due to the operation mechanism of the CCD sensor.

Notes on scalable mode:

- White lines may occur in the upper portions of the screen when strong light exists in a wide area during the scalable mode. This is not a malfunction. If white lines occur, adjust the amount of incident light using the lens.

8. Timing chart

Image data outputs of this camera series are transferred with the UDP protocol of Gigabit Ethernet. Timing numerical value below is prescribed by absolute prerequisite that GiantDragon series use transmission band without restriction of other node. When there is a node transferring with GiantDragon concerned, it is not same the numerical value prescribed below.

(1) In the normal shutter mode

Video format: MONO 8, all pixel readout

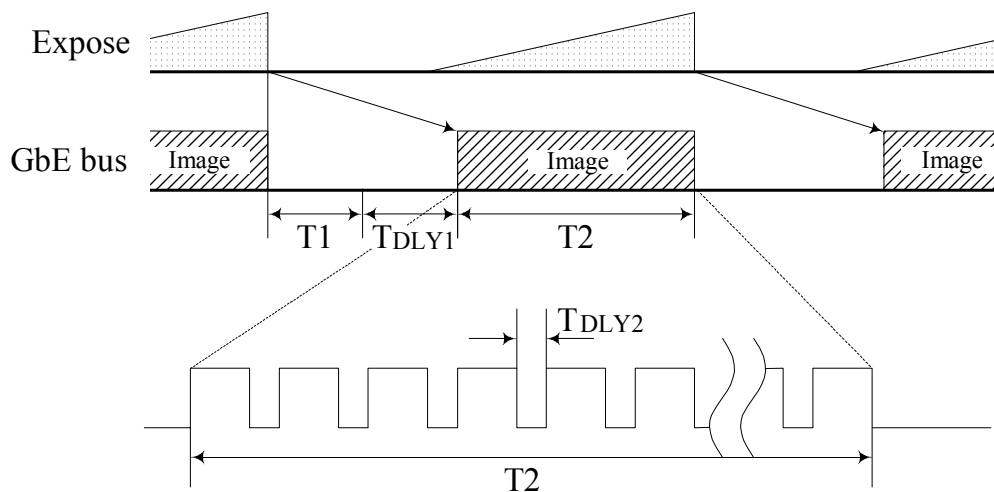

Model name	T1 [ms]	T2 [ms]	Frame rate [ms]
CSGV90BC3	0.5	2.8	11.1
CSGX36BC3	0.5	6.7	27.8
CSGS20BC2	1.0	10.4	50.0
CSGU15BC18	1.0	16.0	66.7
CSGS15BC23	1.0	11.7	56.7

* T1 is the maximum value, and T2 (GVSP_FRAME_RATE) is the minimum value.

* Frame rate is maximum speed.

* At the setting the GVSP_SIZE (SCPSx) = 1500 byte / packet.

(T2 is changed by GVSP_SIZE (SCPSx).)

* Set the value that T_{DLY1} (GVSP_BLOCK_START_DELAY) to satisfy the next numerical formula;

$$T1 + T_{DLY1} + T2 \geq \text{Frame rate}$$

(2) In the random trigger shutter mode

- When fixed mode (Video format: MONO 8, all pixel readout);

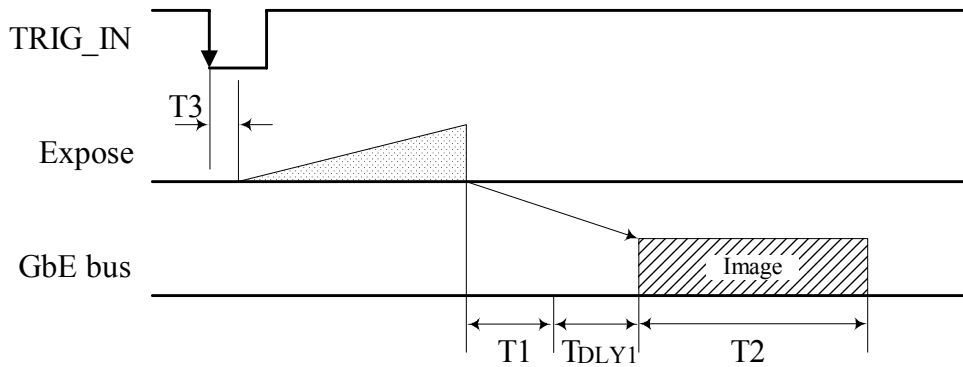

- When pulse width mode (Video format: MONO 8, all pixel readout);

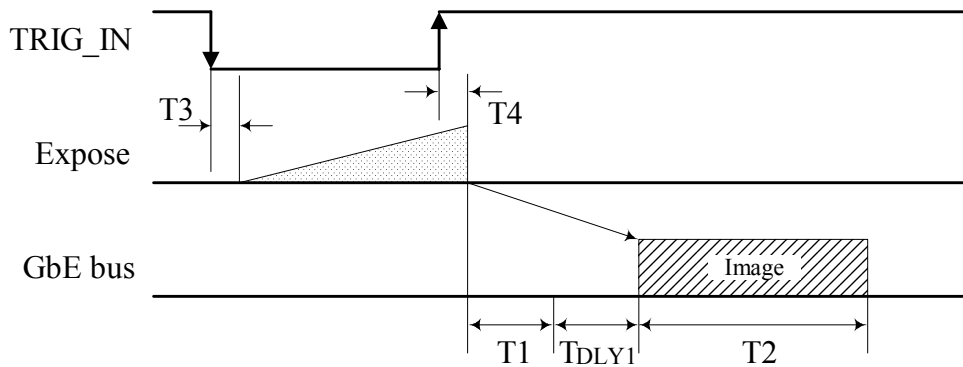

Model name	T3 [us]	T4 [us]
CSGV90BC3	0.9	2.8
CSGX36BC3	1.5	25.2
CSGS20BC2	3.4	5.1
CSGU15BC18	1.9	7.5
CSGS15BC23	3.8	23.8

* The value of T1 and T2 are the same as the value at the of the normal shutter setting.

9. Troubleshooting

If any trouble occurs in use, check the following first. If the trouble persists, contact your distributor or our sales representatives.

* When user confirms the troubles, please confirms the troubles on the condition that user connected the camera system on the smallest composition and set 1500 byte / packet to the GVSP_SIZE (SCPSx) register for making cause of trouble clear. About the connection of the smallest constitution, please refer to 6.Connection.

Phenomena	Check item
Cannot turn on power	<ul style="list-style-type: none"> - Check the connection of the Camera cable. - Check that the LINK LED(LED2) is lighting. If the LINK LED(LED2) is not lighting, check the connection of the LAN cable. - Check that the Gigabit Ethernet interface board is installed and set up correctly.
Shooting image is not displayed	<ul style="list-style-type: none"> - Check that the LINK LED(LED2) is lighting. If the LINK LED(LED2) is not lighting, check the connection of the LAN cable. - Check that the ACT LED(LED1) is lighting or blinking. - Check that the camera register settings are correct. - Check that the lens aperture is not closed. - Check that the Gigabit Ethernet interface board is installed and set up correctly.
Frame drop occurs on shooting image	<ul style="list-style-type: none"> - If some boards are installed in the PCI slots, remove the other boards.
Shooting image remains still	<ul style="list-style-type: none"> - Check that the camera is not in the random trigger mode. - Check that the ACT LED(LED1) is lighting or blinking.
Cannot control camera from PC	<ul style="list-style-type: none"> - Check that the LINK LED(LED2) is lighting. If the LINK LED(LED2) is not lighting, check the connection of the LAN cable. - Check that the Gigabit Ethernet interface board is installed and set up correctly.

10. Specifications

[Electrical specification]

(1) Imager

All-pixel-data-readout interline transfer CCD

	CSGV90BC3	CSGX36BC3	CSGS20BC2	CSGU15BC18	CSGS15BC23
Number of total pixels (H) * (V)	692 x 504	1077 x 788	1434 x 1050	1688 x 1248	1434 x 1050
Number of effective pixels (H) * (V)	659 x 494	1034 x 779	1392 x 1040	1628 x 1236	1392 x 1040
Number of Video out pixels (H) * (V)	640 x 480	1024 x 768	1280 x 960	1600 x 1200	1360 x 1024
Scanning area (H) * (V)	4.88 x 3.66 mm ² (1/3 type)	4.81 x 3.62 mm ² (1/3 type)	6.47 x 4.84 mm ² (1/2 type)	7.16 x 5.44 mm ² (1/1.8 type)	8.98 x 6.71mm ² (2/3type)
Pixel size (H) * (V)	7.4 x 7.4μm ²	4.65 x 4.65μm ²	4.65 x 4.65μm ²	4.40 x 4.40μm ²	6.45 x 6.45μm ²

(2) Scan method

Non-interlace

(3) Synchronization method

Internal synchronization

(4) Aspect ratio

4:3

(5) Sensitivity

	CSGV90BC3	CSGX36BC3	CSGS20BC2	CSGU15BC18	CSGS15BC23
Standard subject illuminance	600 lx F5.6 1/90s	800 lx F5.6 1/36s	500 lx F5.6 1/20s	400 lx F8 1/15s	400 lx F11 1/15s

(6) Minimum subject illuminance (F1.4, GAIN Maximum, video level 50 %)

	CSGV90BC3	CSGX36BC3	CSGS20BC2	CSGU15BC18	CSGS15BC23
Minimum subject illuminance	5 lx	7 lx	4 lx	2 lx	1.5 lx

(7) Gain

0 to +12 dB (91step)

initial factory setting: 0 dB

(8) Gamma correction

OFF (γ= 1.0 fixed)

(9) Setup-level

6.3 to 25 % (192step)

initial factory setting: 6.3% [Approximately 16digit / 8bit]

(10) Power supply

DC 12V +/-10% (ripple 100 mV(p-p) or less)

(11) Power consumption

3.5W Max (Maximum)

[Internal sync signal specification]

(1) Base clock frequency

36.0000 MHz +/- 100ppm

[Trigger signal specification]

- (1) External trigger input
 - Input level
Low level: 0 to 0.5V
High level: 2.0 to 5.0V
 - Polarity
Positive / Negative bipolar
 - Pulse width
2us (Minimum)
 - Input impedance
High impedance
- (2) Software trigger
Set via the Gigabit Ethernet interface

[Output signal specification]

- (1) BUSY_OUT
The period that input of the trigger signal is forbidden.
 - Output level
LVTTTL
 - Polarity
Positive
- (2) EXPOSE_OUT
The period that this camera exposes.
 - Output level
LVTTTL
 - Polarity
Positive

[Electronic shutter specification]

- (1) Normal shutter
 - PRESET setting
1/100s, 1/250s, 1/500s, 1/1000s, 1/2000, 1/4000,
1/10000, 1/20000s
 - Absolute value setting
any value is set up in 32-bit floating point form within the range
of 1/20000s to 2s.
- (2) Random trigger shutter
 - Fixed mode
The exposure time depends on the normal shutter speed setting.
 - Pulse width mode
The exposure time depends on the pulse width.

[Interface specification]

- (1) Interface system
Gigabit Ethernet IEEE802.3ab (1000BASE-T) conformity
- (2) Transmission speed
1Gbps (Maximum)
- (3) Video output
depends on 7.Functions (1) Format of output image
- (4) Protocol
GigEVision Camera Interface Standard for Machine Vision
Ver. 1.0 conformity
- (5) Conformity Cable
Twist pair (Category 5e or over)
- (6) Cable length
To 100m (at the Unshielded Twist Pair (UTP) cable using)
- (7) Recommended cable
Oki Electric Cable Co., Ltd
HONDA TSUSHIN KOGYO CO., LTD
High bending resistance shielded Cat5e LAN cable
* Because above recommendation cable is high bending resistance,
maximum length of cable is 40m.
* Contact your dealer / distributor for details
of recommended cable.

[Machine externals specification]

- (1) Dimensions 44mm(W) x 29mm(H) x 70mm(D) (Not including protrusion)
- (2) Mass Approximately 120g
- (3) Lens mount C-mount

Notes on combination of C-mount lens:

- Depending on the lens you use, the performance of the camera may not be brought out fully due to the deterioration in resolution and brightness in the peripheral area, occurrence of a ghost, aberration and others. When you check the combination between the lens and camera, be sure to use the lens you actually use. As for the C-mount lens used combining this camera, the projection distance from bottom of the screw should use 9.4mm or less.

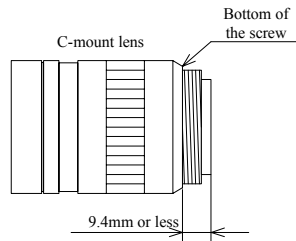

- (4) Flange back it is not possible to adjust it.
- (5) Camera body grounding: insulation status
Conductive between circuit GND and camera body

[Operating Ambient conditions]

- (1) Ambient conditions
 - Performance assurance
 - Temperature 0 to 40°C
 - Humidity 10 to 90% (no condensation)
 - Operating assurance
 - Temperature -5 to 45°C
 - Humidity 90% or less (no condensation)
 - Storage assurance
 - Temperature -20 to 60°C
 - Humidity 90% or less (no condensation)
- (2) EMC conditions
 - EMI (Electro-Magnetic interference) EN61000-6-4 conformity
FCC part15 Subpart B class A conformity
 - EMS (Electro-Magnetic susceptibility) EN61000-6-2 conformity

Notes on Conformity of the EMC:

- About the conformity of the EMC standard of this machine, it has guaranteed in the conditions combined with the option part of 4th clause.
When used combining parts other than specification of our company, I ask you to have final EMC conformity checked of a visitor with a machine and the whole equipment.

[Typical spectral response]

The lens characteristics and light source characteristics is not reflected in table.

<CSGV90BC3>

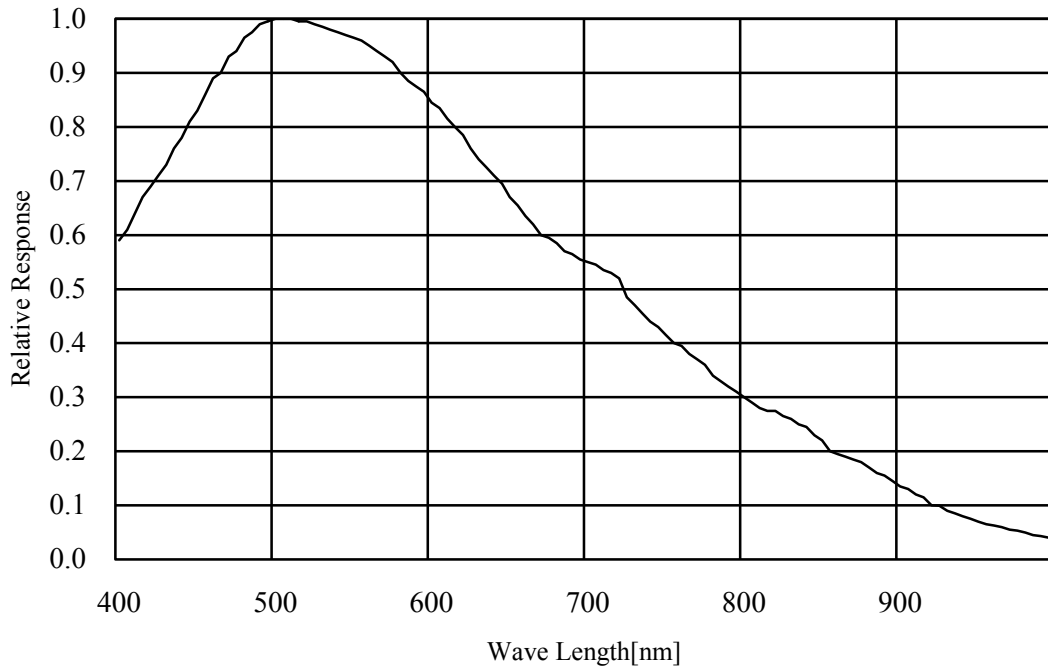

<CSGX36BC3>

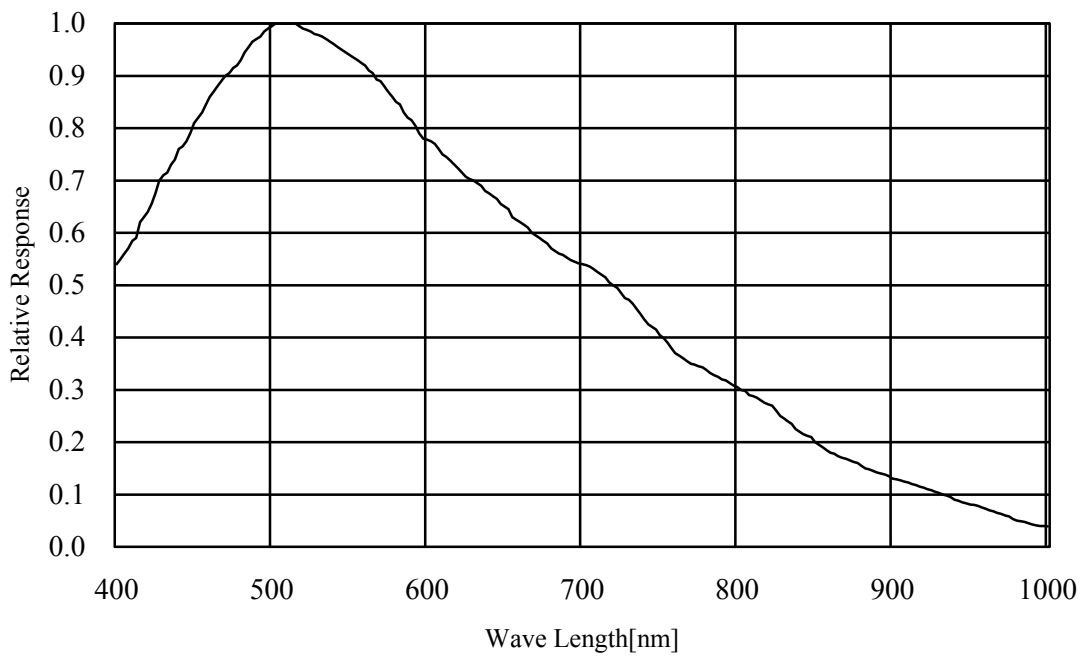

<CSGS20BC2>

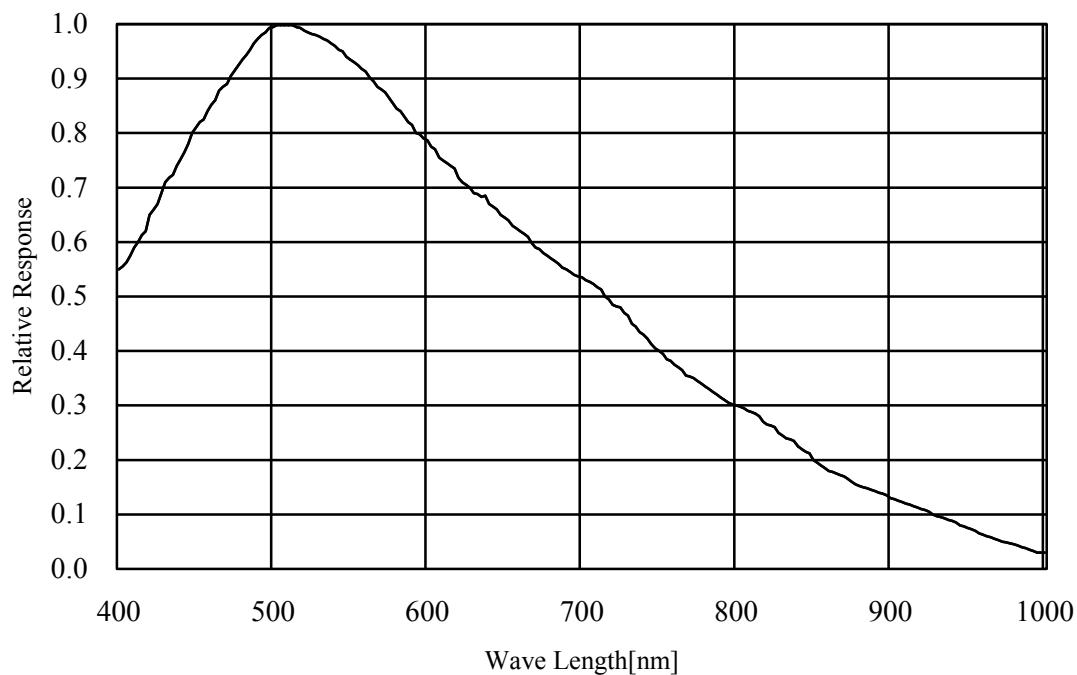

<CSGU15BC18>

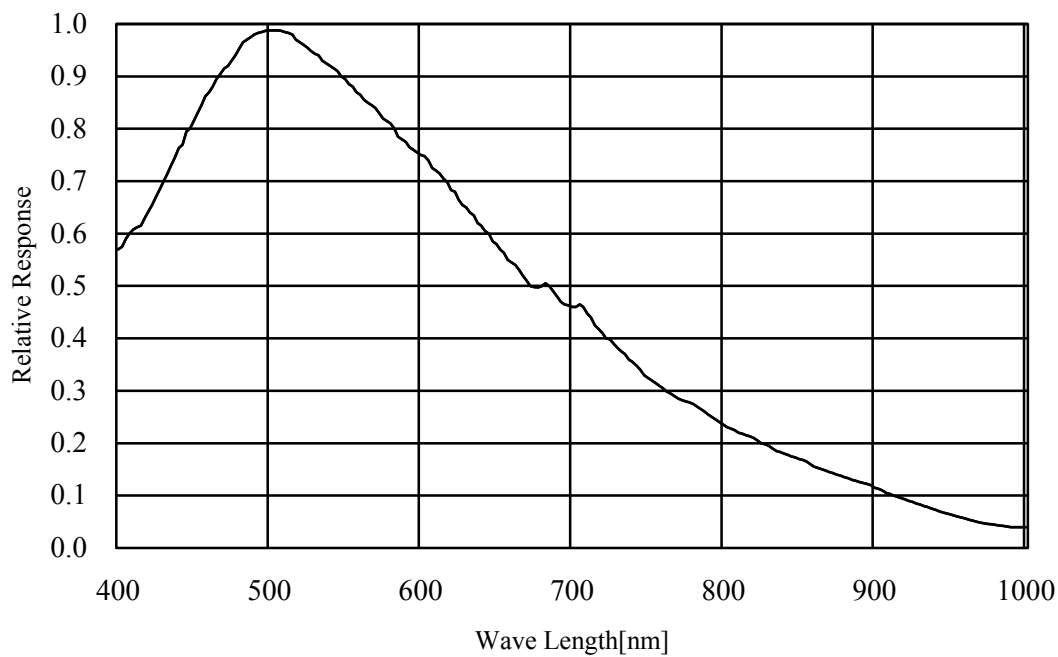

<CSGS15BC23>

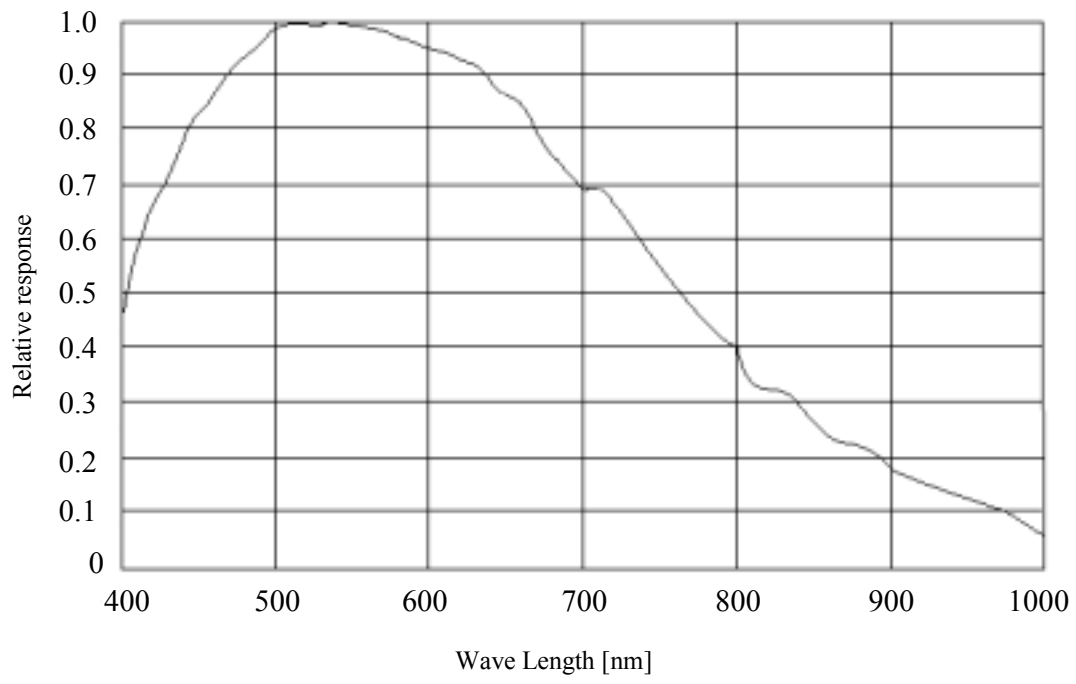

11. Outline Drawing

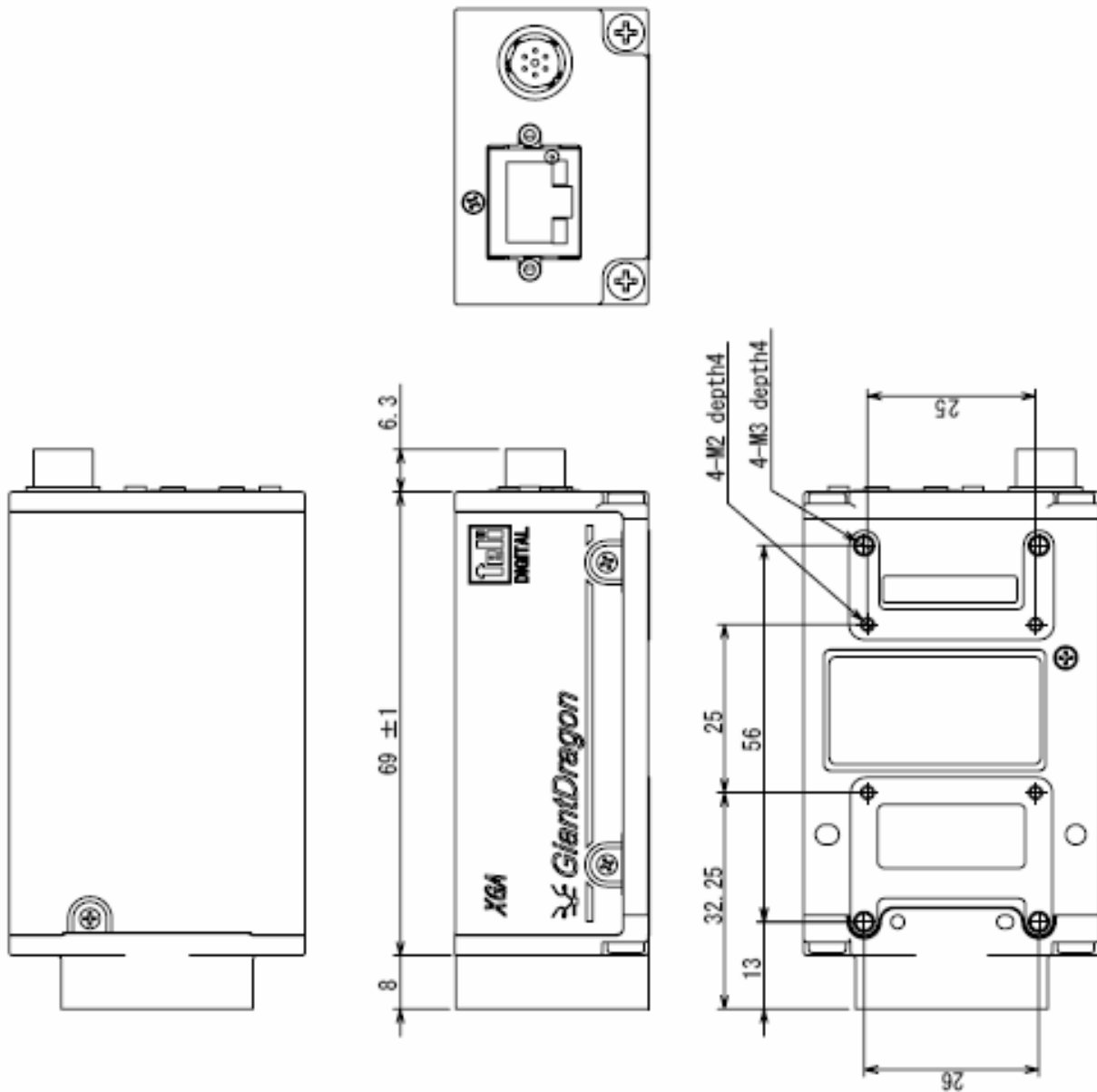

Specification
Material : Aluminium alloy
Surface : Kation coating (Black)
(Cover): Leather-Satin print (Black)
 [Unit : mm]



TOSHIBA TELI CORPORATION

Head Office: 7-1, 4 chome, Asahigaoka, Hino-shi, Tokyo, 191-0065, Japan
(Overseas Sales Department)

Phone : +81-42-589-8771

Fax : +81-42-589-8774

URL : <http://www.toshiba-teli.co.jp>

Distributor

- This product must be classified for disposal according to the laws of each country and municipal laws.
 - Information contained in this document is subject to change without prior notice.
-

Free Manuals Download Website

<http://myh66.com>

<http://usermanuals.us>

<http://www.somanuals.com>

<http://www.4manuals.cc>

<http://www.manual-lib.com>

<http://www.404manual.com>

<http://www.luxmanual.com>

<http://aubethermostatmanual.com>

Golf course search by state

<http://golfingnear.com>

Email search by domain

<http://emailbydomain.com>

Auto manuals search

<http://auto.somanuals.com>

TV manuals search

<http://tv.somanuals.com>