

# 19"/ 48cm HD-Ready Wide-Screen LCD TV FLA-1911B





20060517

## IMPORTANT SAFETY INSTRUCTIONS

### WARNING

To reduce the risk of fire or electric shock, do not expose this equipment to rain or moisture.

	<p><b>CAUTION</b></p> <p>RISK OF ELECTRIC SHOCK DO NOT OPEN</p>	
<p>CAUTION: TO AVOID THE RISK OF ELECTRIC SHOCK, DO NOT REMOVE COVER (OR BACK). NO USER-SERVICEABLE PARTS INSIDE. REFER SERVICING TO QUALIFIED SERVICE PERSONNEL.</p>		



This symbol is intended to alert the user to avoid the risk of electric shock, do not disassemble this equipment by anyone except a qualified service personnel.



This symbol is intended to alert the user to the presence of important operating and maintenance instructions in the literature accompanying the appliance.

### CAUTION

Use of controls or adjustments or performance of procedures other than those specified herein may result in hazardous radiation exposure.

## IMPORTANT SAFETY INSTRUCTIONS

To prevent any injuries, the following safety precautions should be observed in the installation, use, servicing and maintenance of this equipment. Before operating this equipment, please read this manual completely, and keep it nearby for future reference.



- Do not place the equipment on any uneven or unstable carts, stands, tables, shelves etc. The equipment may fall, causing serious injuries to children or adults and serious damage to the equipment itself.
- Use only a cart or stand recommended by the manufacturer. This equipment and recommended cart or stand should be handled with care. Quick stops, excessive force, and uneven surfaces may cause the equipment and recommended cart or stand to overturn.

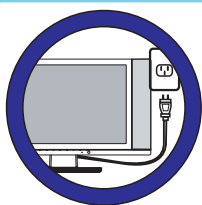

- Do not disable the 3-wire grounding type plug. The grounding pin on the 3-prong plug is an important feature. Removing the grounding pin will increase the risk of damaging the equipment. If you can not fit the plug into the electrical outlet, contact an electrician to install a grounding outlet.
- Always operate this equipment from the type of power source indicated on the rear of the serial/model plate.

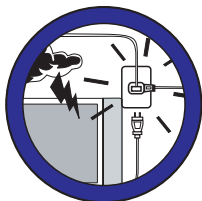

- Never overload wall outlets and extensions.
- Use and handle the power cord with care.
- Do not place any heavy objects on the AC power cord.
- Do not pull the AC power cord. Do not handle the AC power cord with a wet hand.
- Do not touch the power cord and antenna cable during lightning.
- When the equipment has not been used for a long period of time, unplug it from the wall outlet.



- Do not place, use or handle this equipment near water.
- Never expose the equipment to liquid, rain, or moisture. Seek for service if any of the above is spilled into the equipment.



- Do not expose the equipment to extreme temperatures or to direct sunlight, the equipment may overheat and can be damaged.
- Do not install the equipment near any heat sources such as radiators, heat registers, stoves, or any other apparatus that might produce heat.

## IMPORTANT SAFETY INSTRUCTIONS



- Do not attempt to service the equipment yourself.
- Opening and removing the covers may expose you to dangerous voltage or any other hazards and may void your warranty. Refer service from qualified personnel.



- Do not place or drop any other objects on top.
- Do not insert anything into the ventilation holes of your equipment. Inserting any metal or flammable objects may result to fire or electric shock.



- Do not place the equipment on uneven or unstable carts, stands, tables, shelves etc.. The equipment may fall, causing serious injuries to children or adults and serious damages to the equipment itself.
- Always place the equipment on the floor or on a surface that is sturdy, level, stable and strong enough to support the weight of the equipment.



- Do not block any ventilating openings, leave an open space around the equipment.
- Never place the equipment :
  - on a bed, sofa, rug, or any other similar surfaces;
  - too close to drapes/curtains/walls, in a bookcase, built-in cabinet, or any other similar places that may cause poor ventilation.



- Always remove the cord from the outlet before cleaning the equipment.
- Never use cleaners, harsh or abrasive chemicals or solvents on the equipment. Clean only with a dry, soft, lint-free cloth.

## ANTENNA CONNECTION

### EXAMPLE OF OUTDOOR ANTENNA GROUNDING

If an outdoor antenna is connected, follow the precautions below:

- An outdoor antenna should not be located anywhere that can be in contact of overhead power lines, or any other electric light or power circuits.
- When installing an outdoor antenna system, extreme caution should be taken to prevent contact with power lines. Direct contact with power lines may be fatal and should be avoided at all costs.

**CAUTION: Antenna installation should only be carried out by a qualified technician.**

# ANTENNA CONNECTION

## Cable TV (CATV) Connection

- A 75-ohm coaxial cable connector is built into the set for easy hookup. When connecting the 75-ohm coaxial cable to the set, place the 75-ohm cable into the ANT. terminal.
- Some cable TV companies offer premium pay channels. Since the signals of these premium pay channels are scrambled, a cable TV converter/descrambler is generally provided to the subscriber by the cable TV company. This converter/descrambler is necessary for normal viewing scrambled channels. (Set your TV to channel 3 or 4, typically one of these channels are used. If this is unknown, consult your cable TV company.) For more specific instructions on installing cable TV, consult your cable TV company, One possible method of utilizing the coverter/descrambler provided by your cable TV company is explained below.

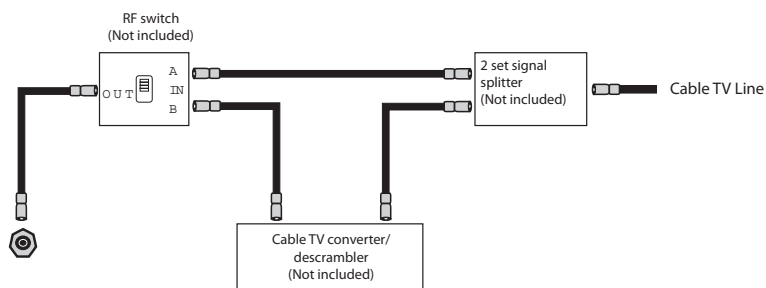

Please note: the RF switch is required to provide two inputs (A and B) . (not included)  
 A position on the RF switch (not included) ; you can view all unscrambled channels by using the TV channel keys.  
 B position on the RF switch (not included) ; you can view all scrambled channels via the converter/descrambler by using the converter channel keys.

# ANTENNA CONNECTION

## ANTENNAS

The antenna requirements for good color TV reception are more important than those of a black & white TV reception. For this reason, a good quality outdoor antenna is strongly recommended.

The following is a brief explanation of the type of connection that is provided with the various antenna systems.

- A 75-ohm system is generally a round cable with PAL-type connector that can easily be attached to a terminal without tools (not included).

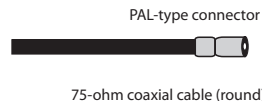

- A 300-ohm system is a flat twin-lead cable that can be attached to a 75-ohm terminal through a 300-75-ohm adapter (not included).

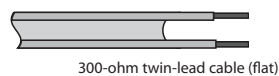

## OUTDOOR ANTENNA

- Use one of the following two diagrams when connecting an outdoor antenna.
  - A: Use a VHF/UHF combination outdoor antenna.
  - B: Use a separate VHF and/or UHF outdoor antenna.
- Connect the outdoor antenna cable lead-in to the ANT. terminal located on the rear of the equipment.

### A. Combination VHF/UHF antenna

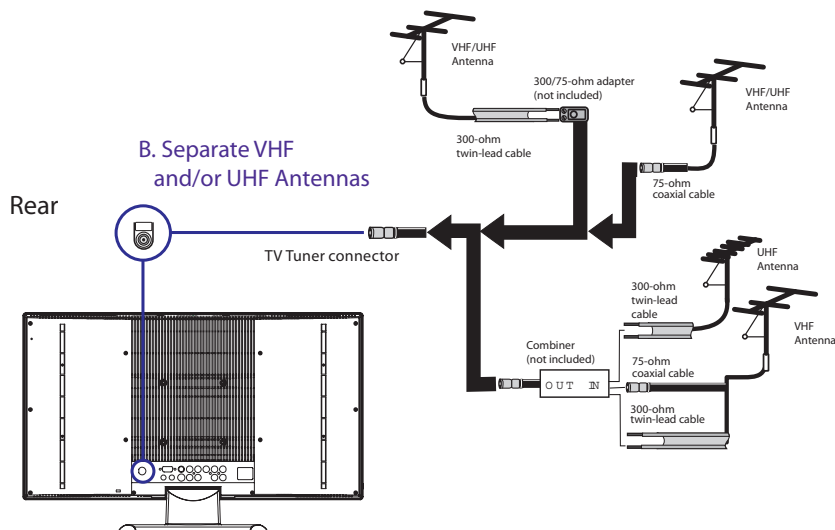

# CONTENT

PREPARATION .....	8
Features .....	8
Package Contents .....	9
LCD TV .....	10
Front View .....	10
Rear View .....	11
Remote Control .....	12
Using your LCD TV.....	14
INSTALLATION .....	15
Connecting a TV Cable or an Antenna .....	15
Connecting a DVD Player .....	16
Connecting a VCR & a Video Camera .....	17
Connecting a TV Box and Satellite Receiver .....	18
USING THE FEATURES .....	19
Basic Operation .....	19
OSD Menu Operation .....	20
Video .....	20
Audio .....	21
Tuner.....	22
Setup .....	23
TROUBLESHOOTING.....	25
SPECIFICATIONS.....	26.



# PREPARATION

Congratulations on the purchase of your new High Definition Compatible Television. In order to maximize the potential of this television, you must use it in conjunction with a High Definition Signal Source, utilizing a proper High Definition receiving unit (often referred to as a "set-top" box). Only "true" High Definition transmitted video will yield optimum picture quality. Please contact your cable or satellite provider for more information on how to receive High Definition programming.

## Features

### Features

- High Brightness / Contrast Image  
Brightness: 450 cd/m<sup>2</sup>  
Contrast Ratio: 500:1
- VGA Support:  
720x400/70Hz~1792x1344/60Hz
- Multimedia Jack  
S-Video Jack  
HD Component Video Jack (YPbPr)  
PC Jack  
A/V Jack
- WSS (Wide Screen Scale ) Function  
This function can automatically convert and display any aspect ration (4:3 / 16:9) TV broadcast signal.
- Support For Teletext Function  
This function can offer all sorts of information provided by TV company.
- NICAM/ FM-Stereo Function
- Searching channels
- Auto search
- Search
- Sleep-Timer
- User selectable color temperature settings
- Enhance audio processing
- Built-In CATV tuner
- Faroudja DCDI Edge Processing



"DCDi® by Faroudja" is a registered trademark of Genesis Microchip Inc.

## Package Contents

Once you open the box, make sure all of the following contents are included. If you're missing any items, please return this product to the original place of purchase.

LCD TV



- Remote control/  
AAA batteries

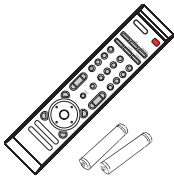

- Video Cable



- Component Cable

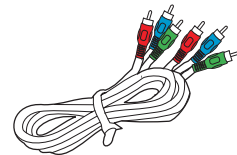

- Power Cord



- Audio Cable

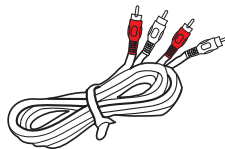

- Warranty Card
- Quick Start Guide
- User's Manual

These items are all you need to set up and operate the LCD TV in its basic configuration.

\*Most devices (VCRs, DVD player, etc.) come with the necessary cable for connection. If you want to set up a complex system, you may need to buy extra cable, connector, etc.

## LCD TV

Front View

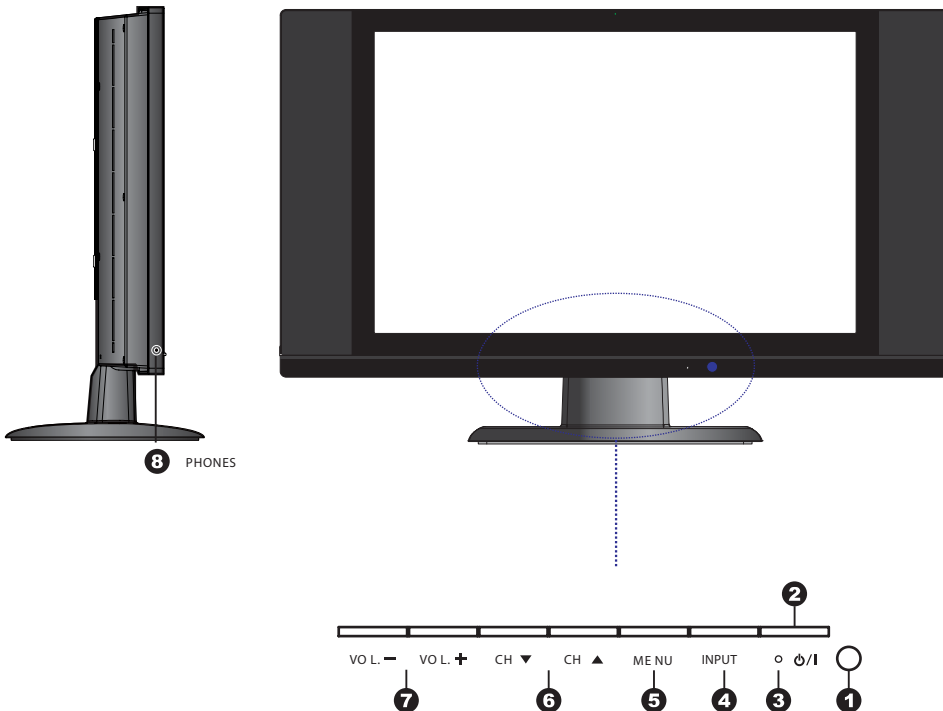

ITEM	DESCRIPTION
1 IR	Infrared Receiver (IR)
2 POWER 	Turns the LCD TV on and off.
3 LED	The LED light indicates when the LCD TV is activated (green light indicates on and amber indicates off).
4 INPUT	Chooses from different input signal sources.
5 MENU	Press MENU to display the OSD (on screen display). Press again to turn the OSD off.
6 CHANNEL	Scans up and down through channels. Selects sub-menu items when in the OSD mode.
7 VOLUME	Adjusts the volume up and down. Changes settings for items and the value for items when in the OSD mode.
8 PHONES	Connects to earphone.



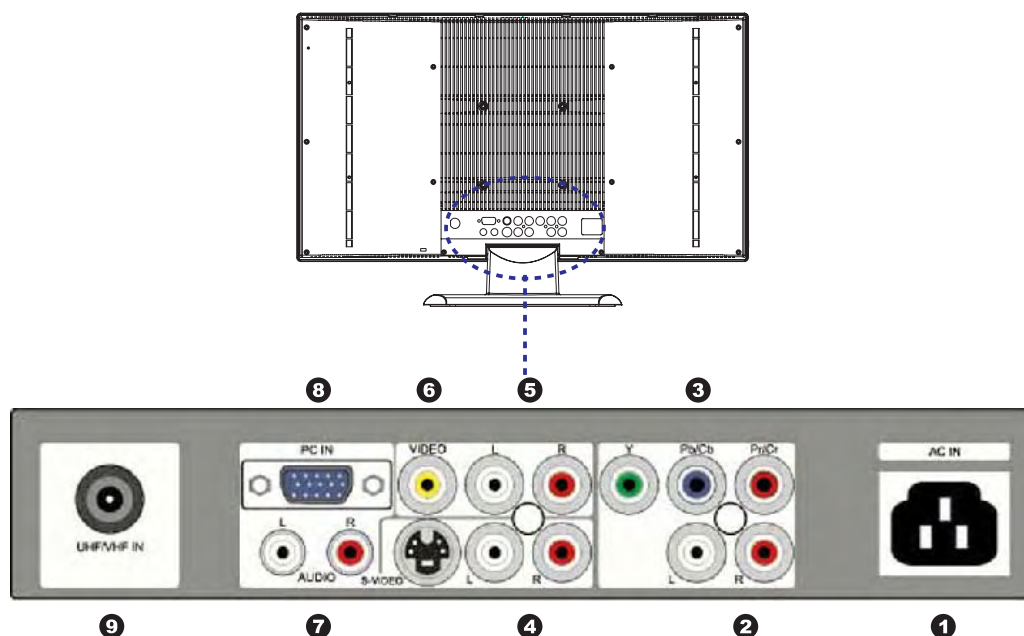

## LCD TV

## Rear View





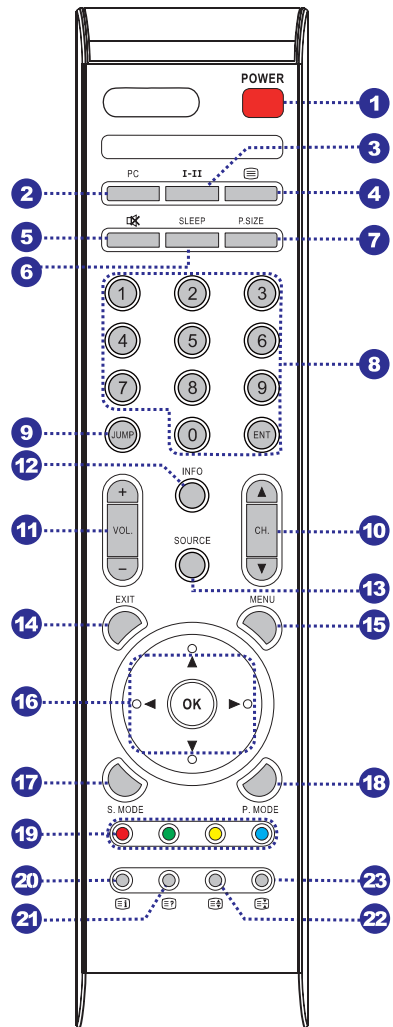

ITEM	DESCRIPTION
1 AC IN	Connects the AC power cord.
2 AUDIO IN 1	Connects to the audio or video equipment with left and right audio output jacks of the component (Y, Pb/Cb, Pr/Cr).
3 COMPONENT	Connects to the component (Y, Pb/Cb, Pr/Cr) video jacks on your DVD player, HDTV Tuner source, or video equipment.
4 S-VIDEO	Connects to the S- VIDEO output jacks and Audio output jacks on your video equipment.
5 AUDIO IN 2	Connects to the audio or video equipment with left and right audio output jacks of the Composite or S-Video.
6 VIDEO	Connects to the composite Video output jack on your video equipment.
7 PC AUDIO IN	Connects the audio input jack of the satellite receiver or other AV equipment.
8 PC IN	Connects the satellite receiver or other AV equipment with D-Sub connector.
9 RF/ANT.	The RF input that connects to your VHF/UHF antenna or cable.

## Remote Control

- 1  **POWER**  
Turns the LCD TV on and into standby mode .
- 2 **PC**  
Press to select PC mode.
- 3 **I-II**  
Cycles through the TV Sound options:  
MONO/DUAL/STEREO
- 4   
Turns on and off the Teletext function.
- 5   
Mutes and restores your LCD TV sound.
- 6 **SLEEP**  
Sets the sleep timer.
- 7 **P.SIZE**  
Selects from the following modes settings: 4:3, 16:9.
- 8 **0-9 and ENTER**  
Select and switch to a channel  
using 0-9 and ENTER buttons.
- 9 **JUMP**  
Switches back and forth between  
the current and previous channels.
- 10 **CH. +/-**  
Changes the channels up and down .
- 11 **VOL. +/-**  
Adjusts the volume.
- 12 **INFO**  
Displays information on the LCD TV screen such as  
channel and channel label.
- 13 **SOURCE**  
Selects from different input signal source:  
TV,AV1 (VIDEO),AV2(S-VIDEO),AV3(HDTV),AV4(VGA).
- 14 **EXIT**  
Exits the OSD menu (on-screen display).
- 15 **MENU**  
Displays on screen menu one by one.  
Exits the current menu.
- 16   
Allows you to move,select and set up the OSD options.
- 17 **SOUND MODE**  
Selects sound mode: Custom, Live, POP, Rock.
- 18 **PIC MODE**  
Selects picture mode:Custom,Vivid, Standard, Mild.



- 19 **DIRECT PAGE**  
Press the appropriate colour to direct access the  
colour page.
- 20   
Displays the main index in Teletext mode.
- 21   
Reveals hidden information such as the answer to a  
quiz in Teletext mode.
- 22   
Displays the top, bottom or all of page, to easily  
read in Teletext mode.
- 23   
Freezes a multi-page passage on screen in Teletext  
mode.

## Remote Control

### Installing the batteries in your remote control

- 1 Pull the tab of the back cover and pull up on the cover to open the battery compartment of the remote control.

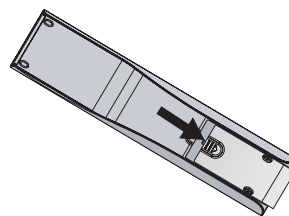

- 2 Insert two AAA size batteries. Make sure to match the (+) and (-) ends of the batteries with the (+) and (-) ends indicated in the battery compartment.

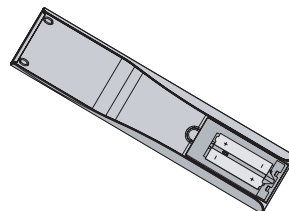

- 3 Align the lower tabs of the back cover to the remote control and snap the cover into place.

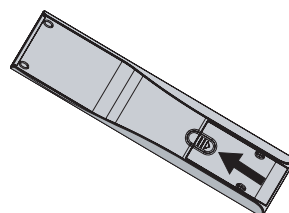

#### Note :

Do not use caustic cleaners (porcelain, stainless steel, toilet, or oven cleaner, etc...). You may cause damage to your remote control.

#### Effective range

Your remote control can be activated from up to the LCD TV 5m away, if pointed directly in front of the device.

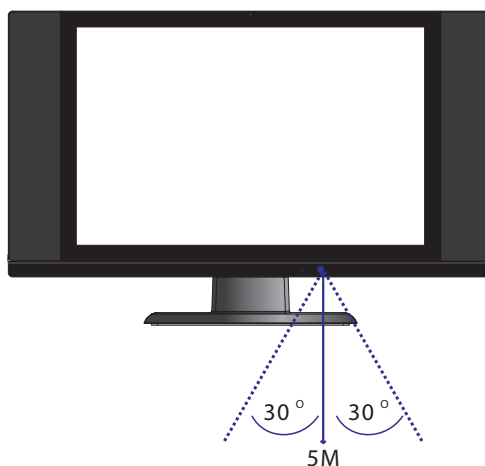

## Using your LCD TV

- 1 You may adjust the tilt angle of the LCD TV about +15 deg. / -0 deg.

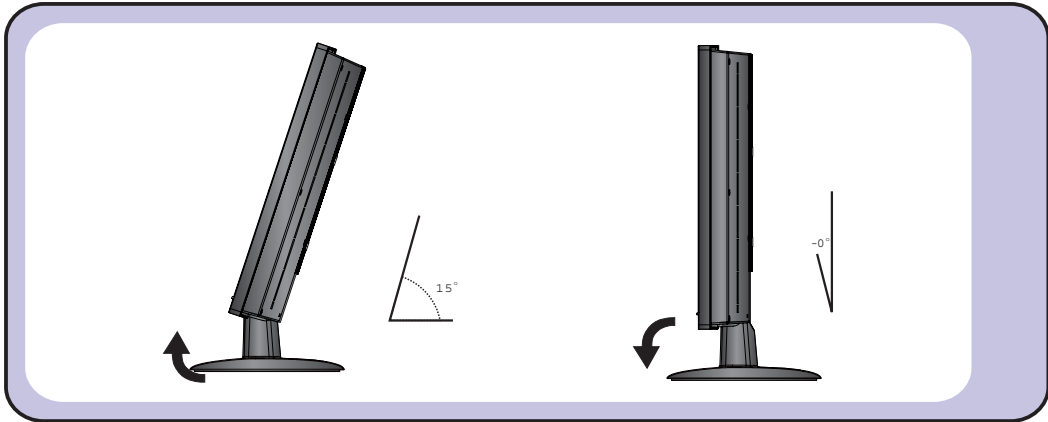

- 2 Always turn the LCD TV off when the LCD TV is not in use for a long period. The Power button is only used for switching the LCD TV into standby mode, it does not disconnect the device from the main voltage. To completely disconnect the main voltage, please switch off the power switch on the rear, or remove the power plug from the socket.

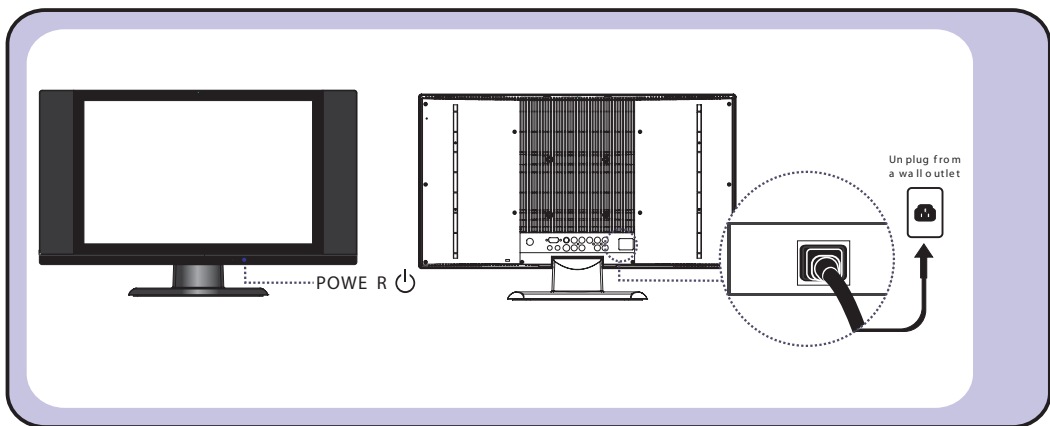

# INSTALLATION

Refer to the owner's manual of the external equipments to be connected. When connecting external equipments, do not connect any AC power cords to wall outlets until you have completed all the connections.

## Connecting a TV cable or Antenna

Basic Connection: Connecting cable or an antenna .

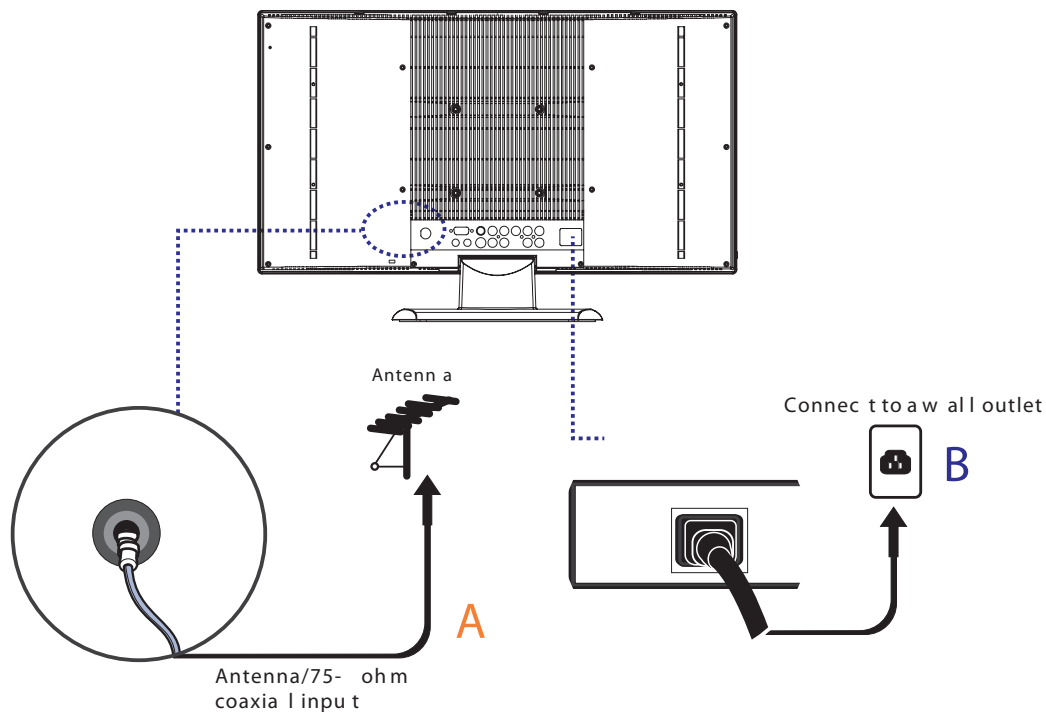

- 1 A: Use a supplied antenna cable to connect the VHF/UHF to your LCD TV.
- 2 B: Connect all AC power sources before turning on the power for the LCD TV or other connected equipments .
- 3 Press the POWER button to turn on your LCD TV.
- 4 Press the TV button directly enter TV mode.



## Connecting a DVD Player

For best picture quality, if your equipment has (RGB) video output, please use component cable instead of a standard video or RGB cable.

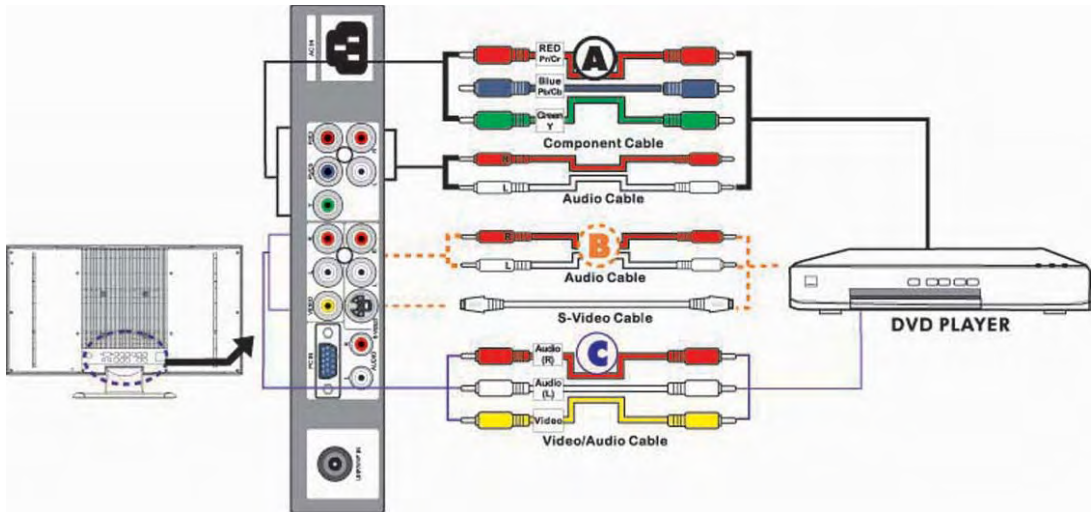

### 1 METHOD A HDTV (AV3)

Use a Component cable to connect the Y/Pb(Cb)/Pr(Cr) jacks on the DVD player to your LCD TV. Use an audio cable to connect the DVD's audio jacks to your LCD TV.

### METHOD B S-VIDEO (AV2)

Use an Audio cable to connect the DVD's audio output jacks to your LCD TV.  
Use a S-Video cable to connect your LCD TV and DVD player.

### METHOD C VIDEO (AV1)

Use an A/V cable to connect the DVD's composite output jacks to your LCD TV.

- 2 Connect all power sources before turning on the power for the LCD TV or other connected equipments .
- 3 Press the POWER button to turn on your LCD TV.
- 4 To watch DVD, press the SOURCE button to select AV1, AV2 or AV3.

## Connecting a VCR & a Video Camera

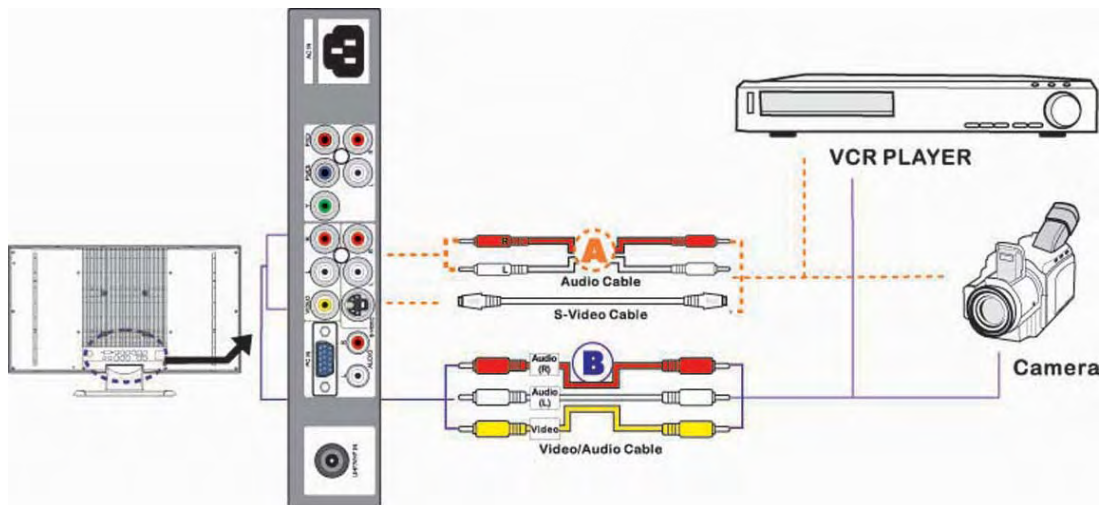

### 1 METHOD A S-VIDEO (AV2)

Use an Audio cable to connect the VCR's/ VIDEO CAMERA's audio output jacks to your LCD TV.

Use a S-Video cable to connect your LCD TV and VCR player/ VIDEO CAMERA.

### METHOD B VIDEO (AV1)

Use an A/V cable to connect the VCR's/ VIDEO CAMERA's. composite output jacks to your LCD TV.

- 2 Connect all power sources before turning on the power for the LCD TV or other connected equipments.
- 3 Press the POWER button to turn on your LCD TV.
- 4 To watch VCR or VIDEO CAMERA, press the SOURCE button to select AV1 or AV2.

Note: Not all cameras have the ability to connect to a TV. Please check your video camera user guide for compatibility.

## Connecting a TV Box and Satellite Receiver

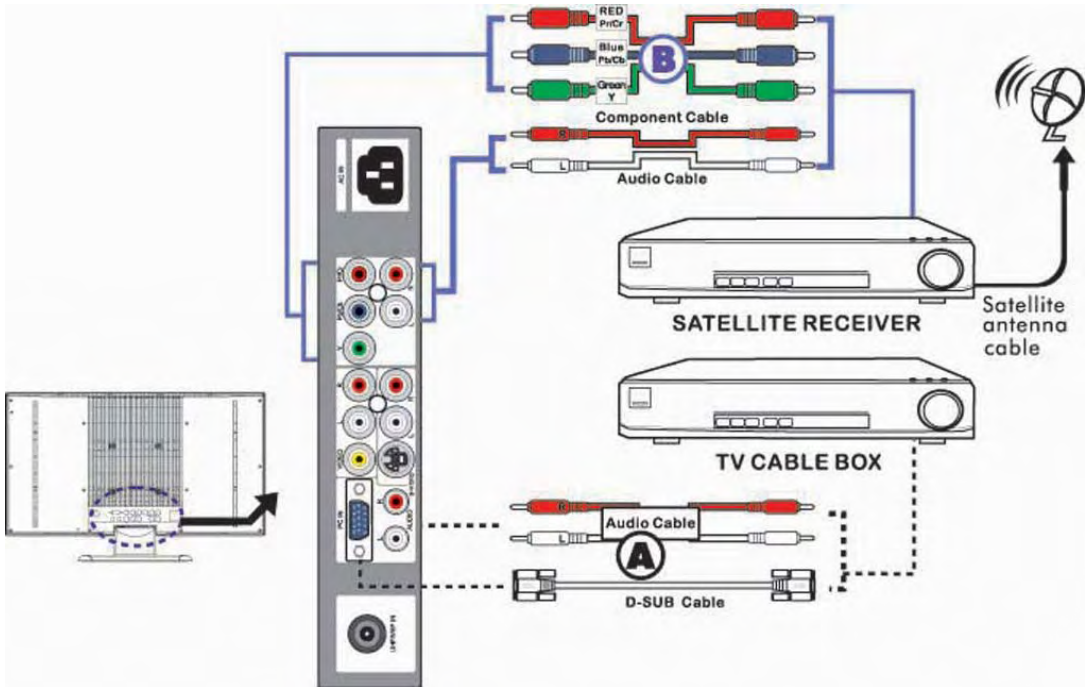

- 1 **METHOD A VGA (AV4)**  
Use a D-SUB cable to connect the TV Cable Box D-SUB connector to your LCD TV.  
Use an Audio cable to connect the TV Cable Box and your LCD TV.

### METHOD B HDTV (AV3)

- Use a component cable to connect the Y/Pb(Pb)/Pr(Cr) jacks on the satellite receiver to to your LCD TV.  
Use an Audio cable to connect the Satellite Receiver audio jacks to your LCD TV.

- 2 Connect all power sources before turning on the power for the LCD TV or other connected equipments.
- 3 Press the POWER button to turn on your LCD TV.
- 4 To watch programs via satellite receiver, or to watch TV via TV cable box, press the SOURCE button to select AV3 or AV4.

# USING THE FEATURES

## Basic Operation

### Turning the TV On and Off

---

- 1 After connecting a CATV or antenna to your LCD TV, and turn the POWER SWITCH of rear TV on, an amber LED light indicates when the LCD TV is activated.
- 2 Press the POWER button, the LED green light indicates on.
- 3 Press the POWER button, the LED amber light indicates off.

### Select Source

---

Press the SOURCE button to display the selection signal on the screen.

### Select TV Channel

---

- 1 Press the CH+/- button on the remote control and the CHANNEL ▲/▼ button on the LCD TV to select channel.
- 2 Press the 0~9 buttons then press the ENTER button to input the channel No. and enter into the selection channel No.
- 3 Press the JUMP button on the remote control to swap the channel between the current channel No. and the previous channel No.

### Adjusting the Volume

---

Press the VOL +/- button on the remote control or the VOLUME +/- button on the LCD TV to adjust the volume.

### To Mute the Sound

---

- 1 Press MUTE and the sound cuts off.
- 2 To turn mute off, press the MUTE button again, or simply press the VOL +/- buttons.

### Sleep Timer

---

System to enter Power Down Mode in 20 Sec

Press the SLEEP button continuously to select the sleep timer or turn the sleep timer from the OFF, 15, 30, 45, 60, 90 and 120 minutes; when the LCD TV has been reached the set time, it will automatically turn off. If the TV has no input signal, the screen will appeared blue screen and display NO Signal; The TV will automatically change stand by after 15 minutes.

## OSD Menu Operation



1 The main menu provides access to the following menus:

Video	Adjust picture setting such as brightness, contrast, saturation and color temp.
Audio	Adjust sound option and effects.
Tuner	Adjust channel searching such as auto search, manual search.
Setup	Set up miscellaneous fetures.

2 Press the MENU button on the remote control. The main menu will appear on the screen.

3 Use ▲/▼ to highlight your main menu option, then press OK to enter your selected option. Use ▲/▼ to highlight an option of the sub-menu. Use ◀/▶ to change the value of the item. Press the EXIT button to exit MENU.

## Video

Use this Video setting menu to adjust the picture quality which best corresponds to your viewing requirements. The Video Menu includes the following options:

OPTION	DESCRIPTION	
PIC Mode	Custom: Select for user's settings.	
Custom	Vivid: Select for enhanced picture contrast and sharpness.	
Vivid	Standard: Select for standard picture settings. Recommended for home entertainment.	
Standard	Mild: Select for mild picture settings.	
Mild	Brightness	Adjust to brightness or darken the picture.
Brightness	Contrast	Adjust the difference between the brightness and darkest regions of the picture.
Contrast	Hue	For NTSC only.
Hue	Saturation	Controls the color intensity.
Saturation		
Sharpness		
Color Temp		
Advanced		

## Video



Sharpness Adjust to sharpen or soften the picture.

OPTION	DESCRIPTION
--------	-------------

Color Temp.	Standard: Select to give the white colors a neutral tint.
-------------	---

	Warm: Select to give the white colors a reddish tint.
--	---

	Cool: Select to give the white colors a bluish tint.
--	--

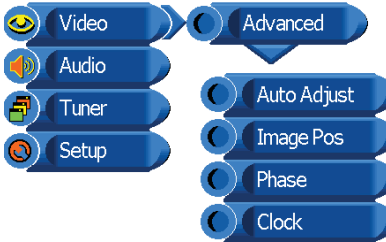

Advanced (VGA Mode only) Auto Adjust: Allows you to select the image auto adjust to be Yes or No.

Image Pos	Allows you to move the position of the picture in the window.
-----------	---

Phase	Increase the focus clarity in the picture and image stability. (Available only for PC input.)
-------	---

## Audio

Use this AUDIO setting menu to adjust the sound quality which best corresponds to your listening requirements.



OPTION	DESCRIPTION
--------	-------------

Volume	Allows you to adjust the volume add or subtract.
--------	--

Bass	Adjust low frequency audio response.
------	--------------------------------------

Treble	Adjust high frequency audio response.
--------	---------------------------------------

Balance	Adjust to emphasize left or right speaker balance.
---------	--

Surround	Allows you to select the surround to be ON or OFF.
----------	--

Sound Mode	Allows you to select the sound mode to Custom, Live, POP, or Rock.
------------	--



## Tuner



Use this Tuner setting menu to select Color System, Audio System, Auto Search, Manual Install, Prog Organizer.



OPTION	DESCRIPTION
Color System	Allows you to select the color system : PAL,SECAM.



Audio System	Allows you to select the audio system : I, BG, DK.
I	PAL I/II (U.K. / Ireland / Hong Kong / South Africa)
BG	PAL B/G, SECAM B/G (Europe / East Europe / Asia / New Zealand / M.East / Africa / Australia)
DK	PAL D/K, SECAM D/K (East Europe / China /



Auto Search	Press to begin auto search. Auto search completed.All receivable stations are stored.
-------------	---



Manual Install	Press the ◀/▶ button to select Search, Fine Tune, CH NO, Band.
----------------	--



Search	Manual Search
Fine Tune	Allows you to adjust the fine tune level by hand if signal is too weak or picture is blurry.
CH NO	Allows you to display the present program number.
Band	Select VHF-L, VHF-H, UHF.





## Tuner



OPTION	DESCRIPTION
--------	-------------

Prog Organizer	This function enables you to delete or skip the stored programme. Also you can move some stations to other programme numbers or copy a programme to the selected programme number.
----------------	--

## Setup

Use this Setup setting menu to set up some features: Language, OSD Time Out, Sleep Time, Reset.



OPTION	DESCRIPTION
--------	-------------

Language	Display English only.
----------	-----------------------



OSD Time Out	Allows selection of the display time of the on-screen menu:5 sec,10 sec,15 sec, 20 sec,25 sec, and 30 sec.
--------------	--





## Setup



## OPTION

## DESCRIPTION

## Sleep Time

Sets up a certain time to shut off automatically:OFF/15/30/45/60/90/120 minutes.

## Reset

Allows you to restore the factory settings.

# TROUBLESHOOTING

Before consulting service personnel, check the following chart for a possible cause of the trouble you are experiencing and for a solution.

PROBLEM	SOLUTION
<b>TV will not turn on</b>	<ul style="list-style-type: none"> <li><input type="checkbox"/> Make sure the power cord is plugged in.</li> <li><input type="checkbox"/> The batteries in the remote control may be exhausted. Replace the batteries.</li> </ul>
<b>No picture, no sound</b>	<ul style="list-style-type: none"> <li><input type="checkbox"/> Check the interface cable between TV and antenna/cable TV.</li> <li><input type="checkbox"/> Press the <b>Power</b> button on the remote.</li> <li><input type="checkbox"/> Press the <b>TV</b> button on the remote, then press the <b>INPUT</b> button repeatedly to select the connected video sources.</li> </ul>
<b>Poor picture, sound OK</b>	<ul style="list-style-type: none"> <li><input type="checkbox"/> Check the interface cable between TV and antenna/cable TV.</li> <li><input type="checkbox"/> Try another channel, the station may have broadcast difficulties.</li> <li><input type="checkbox"/> Adjust the Brightness/Contrast options in the <b>Video</b> Menu.</li> </ul>
<b>Picture OK, Poor sound</b>	<ul style="list-style-type: none"> <li><input type="checkbox"/> Sound may be muted. Press the <b>MUTE</b> button on the remote.</li> <li><input type="checkbox"/> Press the <b>TV</b> button on the remote, then press the <b>VOL. +</b> button to increase the volume.</li> </ul>
<b>Audio noise</b>	<ul style="list-style-type: none"> <li><input type="checkbox"/> Move any infrared equipment away from the TV.</li> </ul>

Please Call 1300 366 144 for  
Service and Support.

# SPECIFICATIONS

Model	FLA-1911B
Panel System	19 inch/48cm LCD panel
Display Resolution	1440 pixels (horizontal) x 900 pixels (vertical)
Television System	PAL SECAM
Brightness	400 cd/m <sup>2</sup>
Contrast Ratio	500:1
Inputs/Output	
Composite Video In	1
S-Video In	1
Component In	1
PC	1
PC Audio In	1
Audio In	3
TV	1
Speaker Out	3 W+3 W
Power Source(MAX)	100-240 V~, 50/60 Hz, 50 W
Dimension( W x D x H)	22.6 inch x 6.7 inch x 14.6 inch
Weight(Net)	12.33 LBS

Please Call 1300 366 144 for Service and Support.

## Display Mode

For the display modes listed below, the screen image has been optimized during manufacture.

### VGA TIMING

Dot X Line	Horizontal Frequency(kHz)	Vertical Frequency(Hz)
640 x 480	31.46	59.94
640 x 480	37.86	72.80
640 x 480	37.50	75.00
720 x 400	31.46	70.40
800 x 600	35.15	56.25
800 x 600	37.87	60.31
800 x 600	48.07	72.18
800 x 600	46.87	75.00
1024 x 768	35.52	86.95
1024 x 768	48.36	60.00
1024 x 768	56.47	70.06
1024 x 768	60.02	75.02
1152 x 864	67.50	75.00
1280 x 960	60.00	60.00
1280 x 1024	63.98	60.02
1280 x 1024	79.97	75.02
1440 x 900	55.93	59.88
1440 x 900	70.63	74.98
1600 x 1200	75.00	60.00
1600 x 1200	81.25	65.00
1600 x 1200	87.50	70.00
1600 x 1200	93.75	75.00
1792 x 1344	83.64	60.00



## Free Manuals Download Website

<http://myh66.com>

<http://usermanuals.us>

<http://www.somanuals.com>

<http://www.4manuals.cc>

<http://www.manual-lib.com>

<http://www.404manual.com>

<http://www.luxmanual.com>

<http://aubethermostatmanual.com>

Golf course search by state

<http://golfingnear.com>

Email search by domain

<http://emailbydomain.com>

Auto manuals search

<http://auto.somanuals.com>

TV manuals search

<http://tv.somanuals.com>