

32" LCD Television FLM-3225



20051020

Table of Contents

Important Information.....	1
Important Safety Precautions	2
Preparations	5
Using the Remote Control.....	5
Batteries for the Remote Control	5
Power Connection.....	5
Antenna Connection	6
Identification of Controls.....	7
Main Unit.....	7
Remote Control.....	9
Connections.....	11
Cautions Before Connecting	11
Connect a VCR	11
Connect a Camcorder	12
Connect a DVD player.....	13
Connect a product to HDMI.....	14
Connect a PC.....	15
Connect a VCR for Recording.....	16
Turning the Unit On and Off.....	17
Turning the Unit On and Off	17
Viewing the Menus and Displays	17
Memorizing the Channels.....	18
Selecting the Signal Source	18
Storing Channels in Memory Automatically.....	18
Adding and Erasing Channels.....	19
Basic Operations	20
Changing Channels.....	20
Adjusting the Volume.....	20
Select Input Source Signal	21
Selecting a Menu Language.....	21
Setting Picture	22
Customizing the Picture	22
Using the Preset Picture Mode.....	22
Adjusting Screen Aspect	23
Reducing Picture Noise	23
Freezing Picture	23
Setting Timer	24
Setting Clock Time	24
Setting ON timer.....	24
Setting OFF timer.....	24
Setting Sleep Timer.....	25
Setting Sound	26
Customizing the Sound	26
Using the Preset Sound Mode	26
Selecting Stereo Mode	27
Adjusting On-Screen Display	28
Adjusting OSD Position	28
Adjusting OSD Transparency	28

Table of Contents (continued)

Setting OSD Timeout	28
PIP Operations	29
Viewing and Changing the Position of the PIP Frame	29
Selecting the Signal Source for the PIP Frame.....	29
Selecting Sound Source for PIP Frame	29
Viewing Closed Caption.....	30
Selecting Closed Caption	30
Adjustment in VGA Mode	31
Adjusting the Picture	31
Adjusting Image Size.....	31
Changing the Position of Image	32
Adjusting the CLOCK and PHASE	32
Adjusting the Picture Automatically	32
Adjusting Parental Control Settings	33
Parental Control	33
Accessing PARENTAL CONTROL	34
Changing the Password	35
Turning PARENTAL CONTROL ON or OFF	35
Adjusting the TV RATING.....	35
Adjusting the MOVIE RATING.....	35
Adjusting ENGLISH RATING	36
Adjusting FRENCH RATING.....	36
Troubleshooting	37
Specification	38
Programming the Universal Remote Control	39

Important Information

WARNING: TO REDUCE THE RISK OF FIRE OR ELECTRIC SHOCK, DO NOT EXPOSE THIS APPARATUS TO RAIN OR MOISTURE.

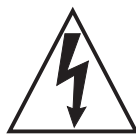
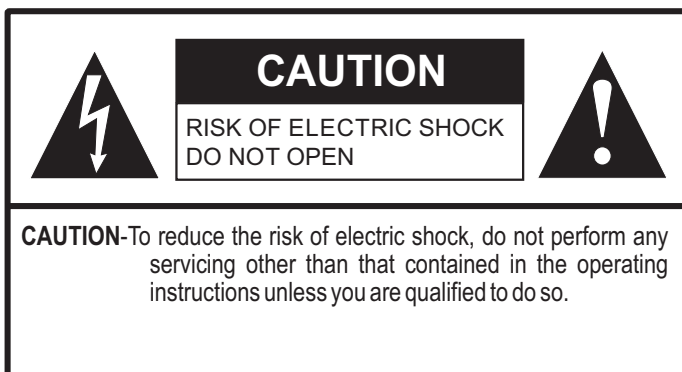

The lightning flash with arrowhead symbol, within an equilateral triangle is intended to alert the user to the presence of uninsulated dangerous voltage within the product's enclosure that may be of sufficient magnitude to constitute a risk of electric shock to persons.



The exclamation point within an equilateral triangle is intended to alert the user to the presence of important operating and maintenance (servicing) instructions in the literature accompanying the appliance.

"Note to CATV system installer: This reminder is provided to call the CATV system installer's attention to Article 820-40 of the National Electrical Code that provides guidelines for proper grounding and, in particular, specifies that the cable ground shall be connected to the grounding system of the building, as close to the point of cable entry as practical."

This product utilizes tin-lead solder, and fluorescent lamp containing a small amount of mercury. Disposal of these materials may be regulated due to environmental considerations. For disposal or recycling information, please contact your local authorities or the Electronic Industries Alliance: www.eia.org

FCC STATEMENT

FCC Notice

LCD TV: A CLASS B digital device

This equipment has been tested and found to comply with the limits for a Class B digital device, pursuant to part 15 of the FCC Rules. These limits are designed to provide reasonable protection against harmful interference when the equipment is operated in a commercial environment.

This equipment generates, uses, and can radiate radio frequency energy and, if not installed and used in accordance with the instruction manual, may cause harmful interference to radio communications. Operation of this equipment in a residential area is likely to cause harmful interference in which case the user will be required to correct the interference at his own expense.

FCC CAUTION:

Pursuant to 47CFR, Part 15.21 of the FCC rules, any changes or modifications to this monitor not expressly approved by the manufacturer could cause harmful interference and would void the user's authority to operate this device.

WARNING: This is a CLASS B product. In a domestic environment this product may cause radio interference in which case the user may be required to take adequate measures to counter interference.

Important Safety Precautions

Electrical energy can perform many useful functions, but it can also cause personal injuries and property damage if improperly handled. This product has been engineered and manufactured with the highest priority on safety. But **IMPROPER USE CAN RESULT IN POTENTIAL ELECTRICAL SHOCK OR FIRE HAZARD**. In order to prevent potential danger, please observe the following instructions when installing, operating and cleaning the product. To ensure your safety and prolong the service life of your LCD TV product, please read the following precautions carefully before using the product.

1. Read these instructions---All operating instructions must be read and understood before the product is operated.

2. Keep these instructions---These safety and operating instructions must be kept in a safe place for future reference.

3. Heed all warnings---All warnings on the product and in the instructions must be observed closely.

4. Follow all instructions---All operating instructions must be followed.

5. Do not use this apparatus near water---for example, near a bathtub, washbowl, kitchen sink, or laundry tub, in a wet basement, or near a swimming pool, and the like. Do not use immediately after moving from a low temperature to high temperature environment, as this causes condensation, which may result in fire, electric shock, or other hazards.

Apparatus shall not be exposed to dripping or splashing and no objects filled with liquids, such as vases, shall be placed on the apparatus.



6. Clean only with dry cloth---Unplug this product from the wall outlet before cleaning. Do not use liquid cleaners or aerosol cleaners. Use a damp cloth for cleaning if required.

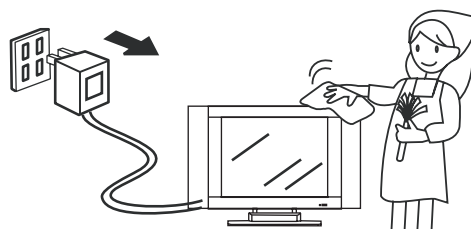

7. Ventilation---Do not block any ventilation openings. Install in accordance with the manufacturer instructions. The vents and other openings in the cabinet are designed for ventilation. Do not cover or block these vents and openings since insufficient ventilation can cause overheating and/or shorten the life of the product. Do not place the product on a bed, sofa, rug or other similar surface, since they can block ventilation openings. This product is not designed for built-in installation; do not place the product in an enclosed place such as a bookcase or rack, unless proper ventilation is provided or the manufacturer's instructions are followed.



8. Heat sources---Do not install near any heat sources such as radiators, heat registers, stoves, or other apparatus (including amplifiers) that produce heat.

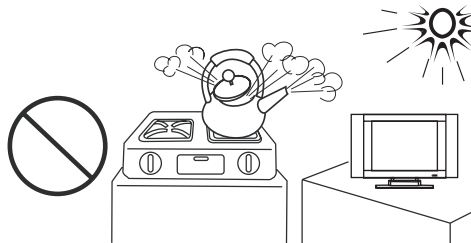

9. Grounding or Polarization---Do not defeat the safety purpose of the polarized or grounding-type plug. A polarized plug has two blades with one wider than the other. A grounding type plug has two blades and a third grounding prong. The wide blade or the third prong are provided for your safety. If the provided plug does not fit into your outlet, consult an electrician for replacement of the obsolete outlet.

10. Power cord protection---Protect the power cord from being walked on or pinched particularly at plugs, convenience receptacles, and the point where they exit from the apparatus.

11. Attachments---Only use attachments/accessories specified by the manufacturer. Do not use attachments not recommended by the manufacturer. Use of improper attachments can result in accidents.

12. Stand---Use only with the cart, stand, tripod, bracket, or table specified by the manufacturer, or sold with the apparatus. Do not place the product on an unstable trolley, stand, tripod or table. Placing the product on an unstable base can cause the product to fall, resulting in serious personal injuries as well as damage to the product. When mounting the product on a wall, be sure to follow the manufacturer's instructions. Use only the mounting hardware recommended by the manufacturer.



13. Move Carefully---When a cart is used, use caution when moving the cart/apparatus combination to avoid injury from tip-over. Sudden stops, excessive force and uneven floor surfaces can cause the product to fall from the trolley.



14. Lightning---Unplug this apparatus during lightning storms or when unused for long periods of time.

For added protection for this television equipment during a lightning storm, or when it is left unattended and unused for long periods of time, unplug it from the wall outlet and disconnect the antenna. This will prevent damage to the equipment due to lightning and power-line surges.

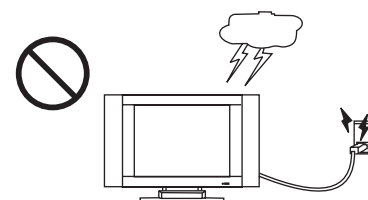

15. Servicing---Refer all servicing to qualified service personnel. Servicing is required when the apparatus has been damaged in any way, such as power-supply cord or plug is damaged, liquid has been spilled or objects have fallen into the apparatus, the apparatus has been exposed to rain or moisture, does not operate normally, or has been dropped.

16. Replacement parts---In case the product needs replacement parts, make sure that the service person uses replacement parts specified by the manufacturer, or those with the same characteristics and performance as the original parts. Use of unauthorized parts can result in fire, electric shock and/or other danger.

17. Overloading---Do not overload wall outlets, extension cords, or convenience receptacles on other equipment as this can result in a risk of fire or electric shock.

18. Entering of objects and liquids---Never insert an object into the product through vents or openings. With high voltage in the product, inserting an object can cause electric shock and/or short internal parts. For the same reason, do not spill water or liquid on the product.

19. Damage requiring service---If any of the following conditions occurs, unplug the power cord from the AC outlet, and request a qualified service person to perform repairs.

- When the power cord or plug is damaged.
- When a liquid is spilled on the product or when objects have fallen into the product.
- When the product has been exposed to rain or water.
- When the product does not operate properly as described in the operating instructions.

Do not touch the controls other than those described in the operating instructions. Improper adjustment of controls not described in the instructions can cause damage, which often requires extensive adjustment work by a qualified technician.

- If the product has been dropped or the cabinet has been damaged in any way.
- When the product displays an abnormal condition or exhibits a distinct change in performance. Any noticeable abnormality in the product indicates that the product needs servicing.

20. Safety checks---Upon completion of service or repair work, request the service technician to perform safety checks to ensure that the product is in proper operating condition.

21. Wall or ceiling mounting---When mounting the product on a wall or ceiling, be sure to install the product according to the method recommended by the manufacturer. This is a safety feature.

22. Power source---This product is intended to be supplied by a listed power supply indicated on the marking label. If you are not sure of the type of power supply to your home, consult your product dealer or local power company. For added protection for this product during a lightning storm, or when it is left unattended and unused for long periods of time, unplug it from the wall outlet and disconnect the cable system. This will prevent damage to the product due to lightning and power line surges. When the unit has to be used with another power supply voltage, the power cable must be changed. Consult your product dealer. The socket outlet should be installed near the equipment and easily accessible. Use only the power cord designated by our dealer to ensure safety and EMC. When connecting other products such as VCRs and personal computers, you should turn off the power of the unit for protection against electric shock.

23. Panel protection---The LCD panel used in this product is made of glass. Therefore, it can break when the product is dropped or impacted upon by other objects. Be careful not to be injured by broken glass pieces in case the LCD panel breaks.

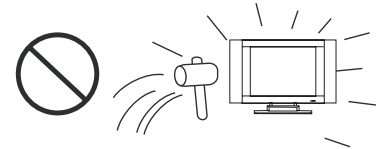

24. Pixel defect---The LCD panel is a very high technology product, giving you finely detailed pictures. Occasionally, a few non-active pixels may appear on the screen as a fixed point of blue, green or red. Please note that this does not affect the performance of your product.

- If an outside antenna is connected to the television equipment, be sure the antenna system is grounded so as to provide some protection against voltage surges and built-up static charges. Section 810 of the National Electrical Code provides information with respect to proper grounding of the mast and supporting structure, grounding of the lead-in wire to an antenna discharge unit, size of grounding conductors, location of antenna-discharge unit, connection to grounding electrodes, and requirements for the grounding electrode.

EXAMPLE OF ANTENNA GROUNDING AS PER NATIONAL ELECTRICAL CODE

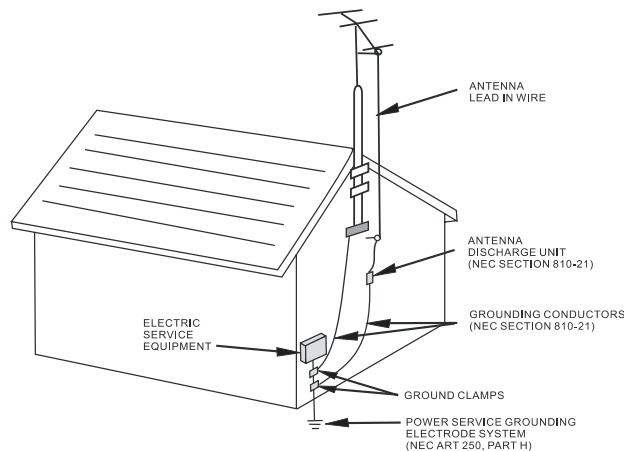

NEC—NATIONAL ELECTRICAL CODE

- An outside antenna system should not be located in the vicinity of overhead power lines or other electric light or power circuits, or where it can collide with such power lines or circuits. When installing an outside antenna system, extreme care should be taken to keep from touching such power lines or circuits, as contact with them might be fatal.

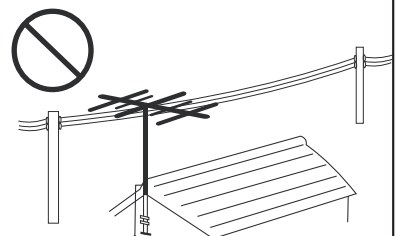

Preparations

Using the Remote Control

- Use the remote control by pointing it towards the remote sensor window of the set. Objects between the remote control and sensor window may prevent proper operation.

Note: This illustration is for reference only. The remote sensor may be in different locations on different models.

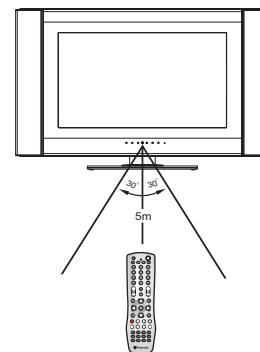

Cautions regarding use of remote control

- Do not expose the remote control to shock. In addition, do not expose the remote control to liquids, and do not place in an area with high humidity.
- Do not install or place the remote control under direct sunlight. The heat may cause deformation of the unit.
- The remote control may not work properly if the remote sensor window of the main unit is under direct sunlight or strong lighting. In such a case, change the angle of the lighting or LCD TV set, or operate the remote control closer to the remote sensor window.

Batteries for the Remote Control

If the remote control fails to operate the LCD TV functions, replace the batteries in the remote control.

1 Open the battery cover.

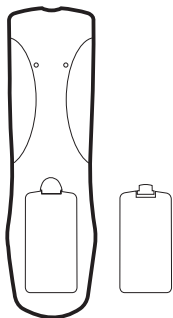

2 Insert two size-AA batteries.

- (Place the batteries with their terminals corresponding to the (+) and (-) indications in the battery compartment.)

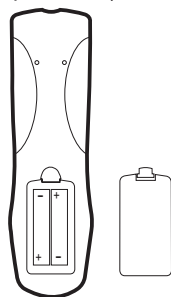

3 Replace the cover.

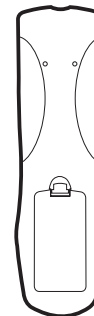

Precaution on battery use

Improper use of batteries can result in a leakage of chemicals and/or explosion. Be sure to follow the instructions below.

- Place batteries with their terminals corresponding to the (+) and (-) indications.
- Different types of batteries have different characteristics. Do not mix batteries of different types.
- Do not mix old and new batteries. Mixing old and new batteries can shorten the life of new batteries and/or cause old batteries to leak chemicals.
- Remove batteries as soon as they are non-operable. Chemicals that leak from batteries can cause a rash. If chemical leakage is found, wipe with a cloth.
- The batteries supplied with the product may have a shorter life expectancy due to storage conditions.
- If the remote control is not used for an extended period of time, remove the batteries from the remote control.

Power Connection

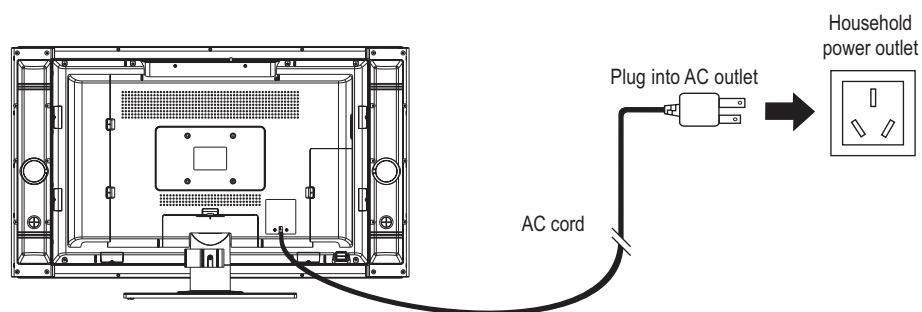

Note:

- This product should be operated only from the type of power source indicated on the marking label.
- Always unplug the AC cord from power outlet when not using for a long period of time.

Antenna Connection

CABLE TV (CATV) CONNECTION

A 75-ohm coaxial cable connector is built into the set for easy hookup. When connecting the 75-ohm coaxial cable to the set, screw the 75-ohm cable to the ANT. Terminal.

Some cable TV companies offer "premium pay channels". Since the signals of these premium pay channels are scrambled, a cable TV converter/descrambler is generally provided to the subscriber by the cable TV company.

This converter/descrambler is necessary for normal viewing of the scrambled channels. For more specific instructions on installing cable TV, consult your cable TV company. One possible method of utilizing the converter/descrambler provided by your cable TV company is explained below. Please note: An RF switch provided with two inputs (A and B) is required (not supplied).

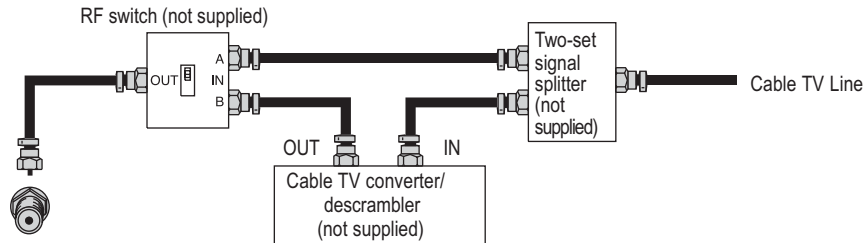

"A" position on the RF switch (not supplied) : You can view all unscrambled channels by using the TV's channel keys.

"B" position on the RF switch (not supplied) : You can view the scrambled channels via the converter/descrambler by using the converter's channel keys.

Note:

Consult your Dealer or Service Center for the type of splitter, RF switch or combiner that might be required.

ANTENNAS

The antenna requirements for good color television reception are more important than those for black & white television reception. For this reason, a good quality outdoor antenna is strongly recommended.

The following is a brief explanation of the type of connections that are provided with the various antenna systems.

1. A 75-ohm system is generally a round cable with F-type connector that can easily be attached to a terminal without tools (not supplied).
2. A 300-ohm system is a flat "twin-lead" cable that can be attached to a 75-ohm terminal through a 300-75-ohm adapter (not supplied).

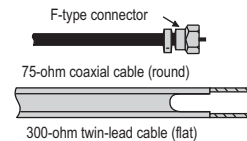

OUTDOOR ANTENNA CONNECTION

Use one of the following two diagrams if you connect an outdoor antenna.

A: Using a VHF/UHF combination outdoor antenna.

B: Using separate VHF and/or UHF outdoor antennas.

Connect the outdoor antenna cable lead-in to the ANT. terminal on the rear of the TV set.

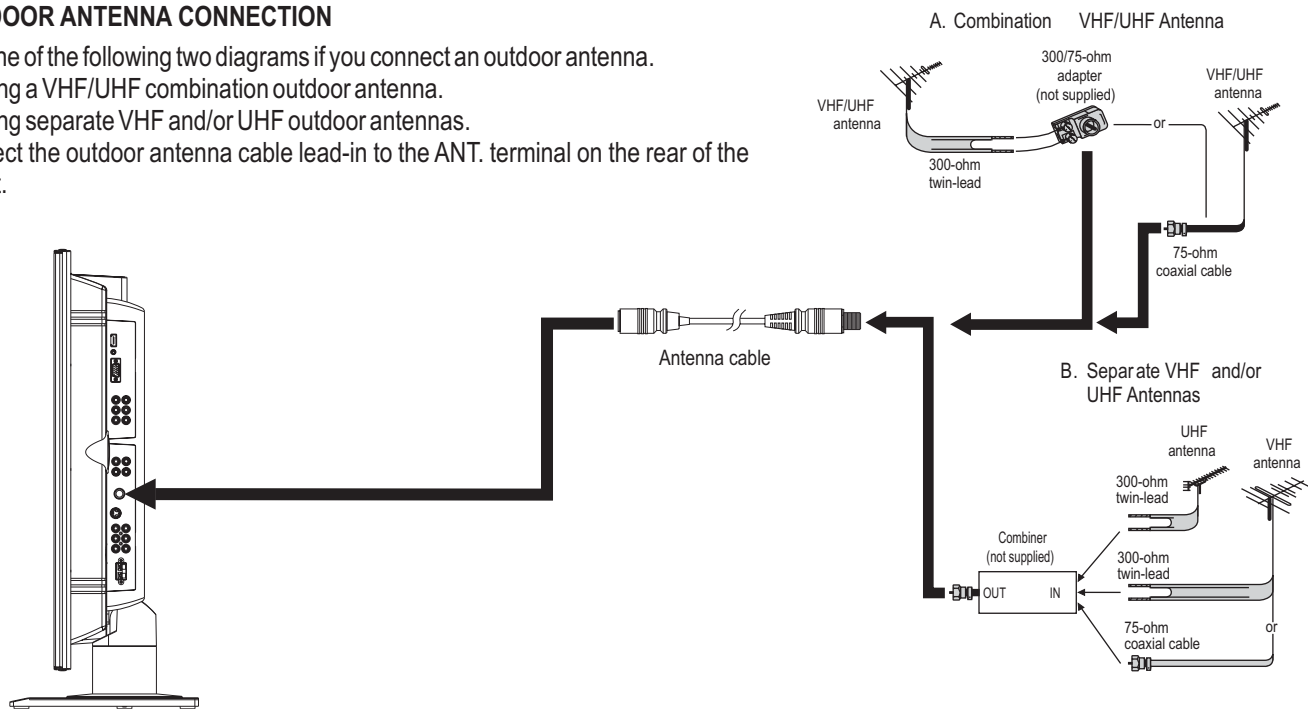

Identification of Controls

Main Unit

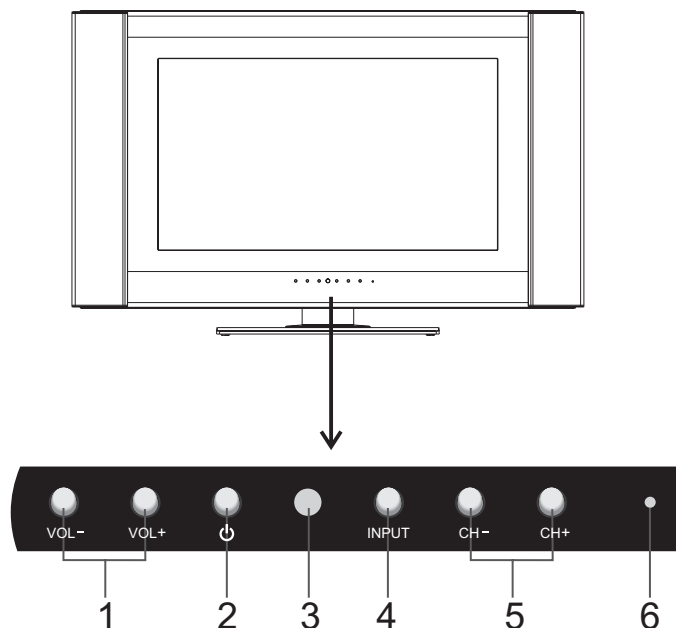

1. VOL+/-

Press the **VOL+** or **VOL-** button to directly increase or decrease the sound volume level;

2. POWER

Press this button to turn the unit ON from STANDBY mode. Press it again to turn the set back to STANDBY.

3. Remote Sensor

4. INPUT

To access signal source select menu

5. CH+/-

Press these two buttons to directly change the TV channel;

6. Power Indicator

Note:

Functions of **VOL+/-**, **CH+/-**, **POWER**  and **INPUT** are also provided to the remote control. This operation manual provides a description based on operating functions with the remote control.

Main Unit

Press and pull out the Cover carefully as the arrow shows (press and pull the two buttons at the same)

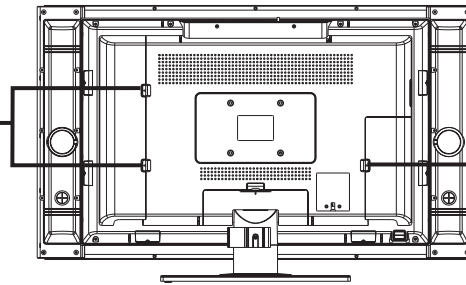

Press and pull out the Cover carefully as the arrow shows

Before you connect external devices with the unit, please removing the Back Cover. After finishing connecting, aim the insertion tabs toward the locating groove, then carefully push the Cover until the Cover locks in place with a click.

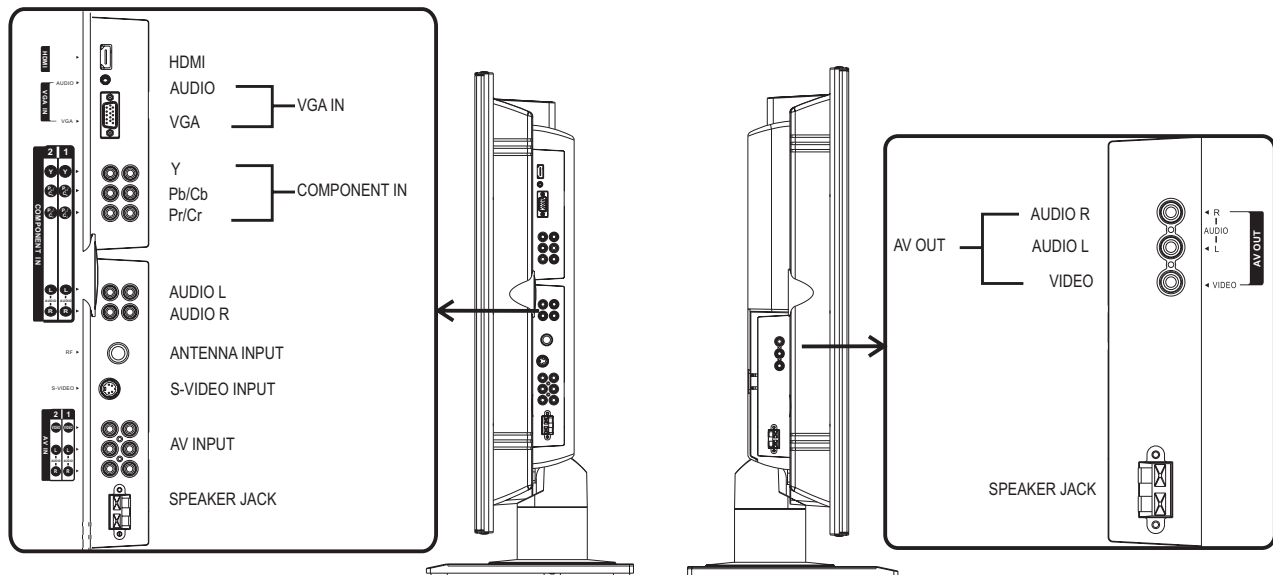

1. HDMI input jack

2. VGA input /AUDIO in

Connect to the VGA/audio output jacks on your equipment

3. COMPONENT input (Y, Pb/Cb, Pr/Cr, Audio L, R)

Connect to the audio and component output jacks of a DVD player or Set-Top Box etc.

4. Antenna input

Allows you to connect cable or outdoor antenna

5. S-Video input

Receive a S-Video signal from external source such as VCR or DVD player.

6. AV inputs (Video, Audio L, R)

Receive video/audio signals from external sources such as VCR or DVD player.

7. AV outputs (Video, Audio L, R)

8. Speaker jack

Connect the speaker audio cable to the speaker output jack on the unit matching "+" and "-" ends of the cable with color.(Before connecting, make sure to unplug the unit and all connected components)

Remote Control

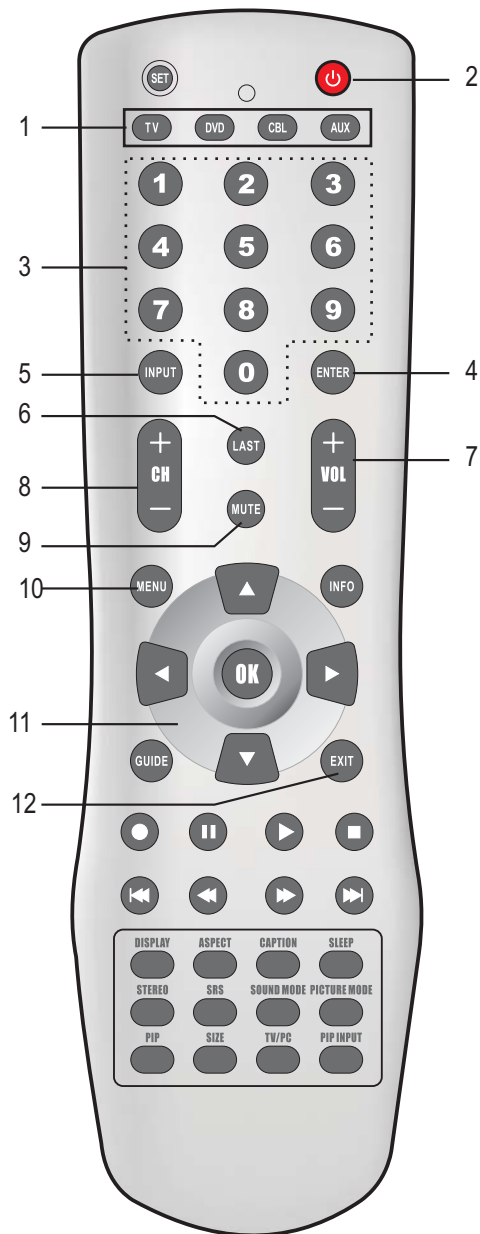

1. To select products to be controlled with remote control

Note: This remote control is an **universal** remote control. If your remote control does not work correctly when you operate the TV set, please try to press **TV** button.

2. POWER

Turn the unit on or off

3. 0~9 number buttons

Direct channel select

4. ENTER button

Channel enter button

5. INPUT

To access source input select menu

6. LAST

To quickly jump between current channel and last selected channel

7. VOL+/-

Used to adjust volume

8. CH+/-

Used to switch channels

9. MUTE

Sound mute

10. MENU

To access the Menu main page or exit menu operation

11. Menu navigation button:

In Menu operation, use  /  to select menu item;

Use  /  to adjust selected item;

OK button

To confirm or enter submenu

12. EXIT

Used to exit menu completely

Remote Control



13. ASPECT

To select screen aspect ratio

14. DISPLAY

To display channel status or signal information

15. STEREO

To select stereo mode

16. PIP

To activate PIP function

17. SIZE

To change the position of the PIP frame and adjust PIP frame size

18. CAPTION

To select CCD on/off and CCD mode

19. SLEEP

To set Sleep timer

20. PICTURE MODE

Picture mode select

21. SOUND MODE

Sound mode select

22. PIP INPUT

To select sound output from the main frame or the PIP frame when in PIP mode

Connections

Cautions Before Connecting

- Carefully check the terminals for position and type before making any connections.
- The illustration of the external equipment may be different depending on your model.
- Loose connectors can result in image or color problems. Make sure that all connectors are securely inserted into their terminals. Refer to the operating manual of the external device as well.
- When connecting an external device, turn the power off to avoid any issues.
-

Connect a VCR

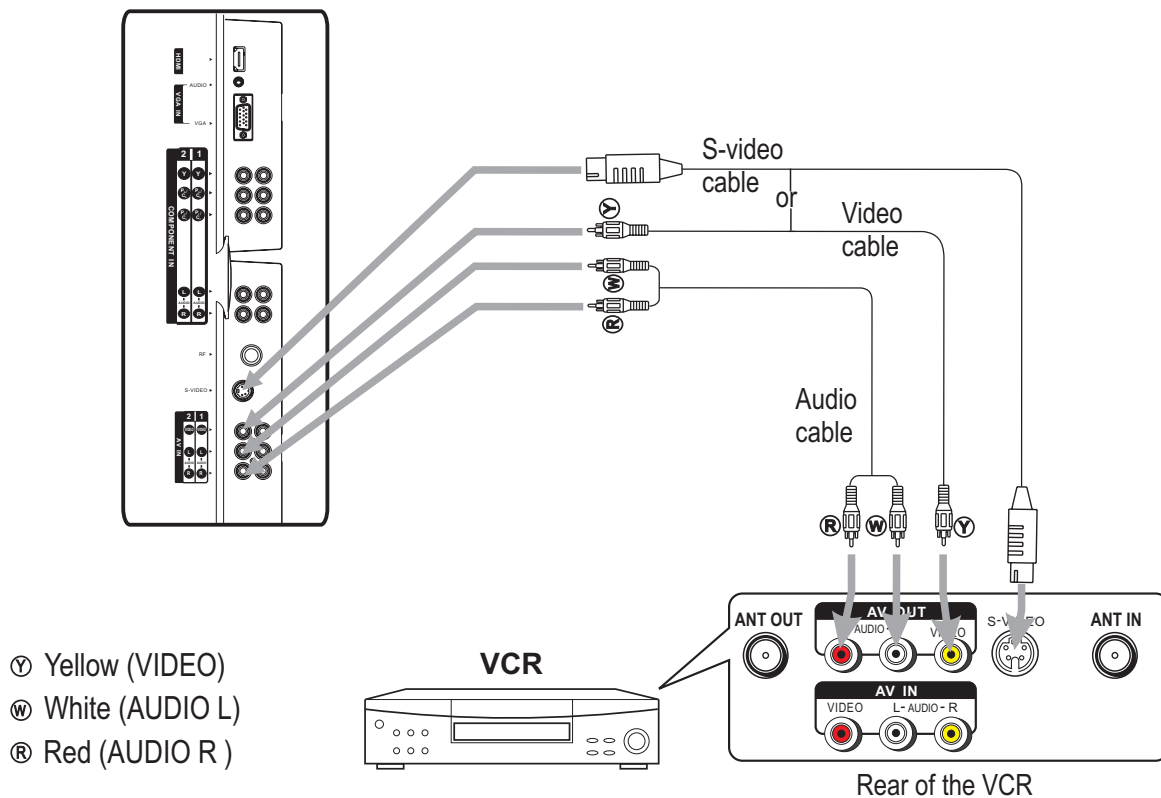

How to connect:

Connect the Audio/Video cables between the Audio (L/R)/Video jacks on the unit and VCR.

Note:

For better video, you can use the **S-video** terminal if your source supports it.

The unit chooses the S-Video signal prior to the Video signal.

The **Video** input terminal on the **AV IN(2)** and the **S-Video** input terminal share the same **Audio** input terminals.

To play VCR

1. Turn on your LCD TV, press **INPUT** button on the remote control.
2. Press **INPUT** button repeatedly to select **AV2/SV**. Note that the period of two-press should be within 2 seconds.
3. Turn on your VCR, insert a videotape and press the Play button.

SOURCE

TV AV1 AV2/SV YPBPR1 YPBPR2 VGA HDMI

Connect a Camcorder

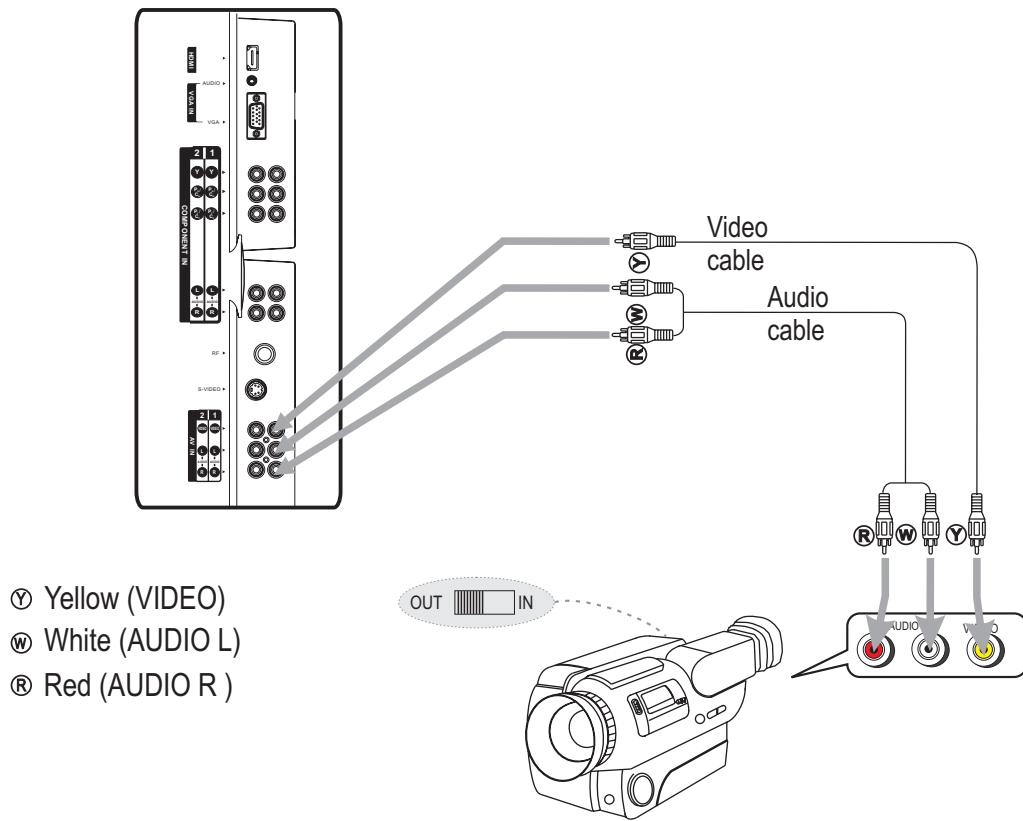

How to connect:

Connect the Audio/Video cables between the Audio (L/R)/Video jacks on the unit and camcorder.

To playback Camcorder

1. Turn on your LCD TV , press **INPUT** button on the remote control.
2. Press **INPUT** button repeatedly to select **AV1**.
3. Turn on your camcorder and set it to output mode. (For details, refer to your camcorder owner's manual.)
4. Insert the tape into the camcorder and press Play button.

SOURCE							
TV	AV1	AV2/SV	YPBPR1	YPBPR2	VGA	HDMI	

Note:

The operations of the camcorder may be different and is dependent on your model. Please read the owner's manual of your camcorder to confirm operation.

Connect a DVD player

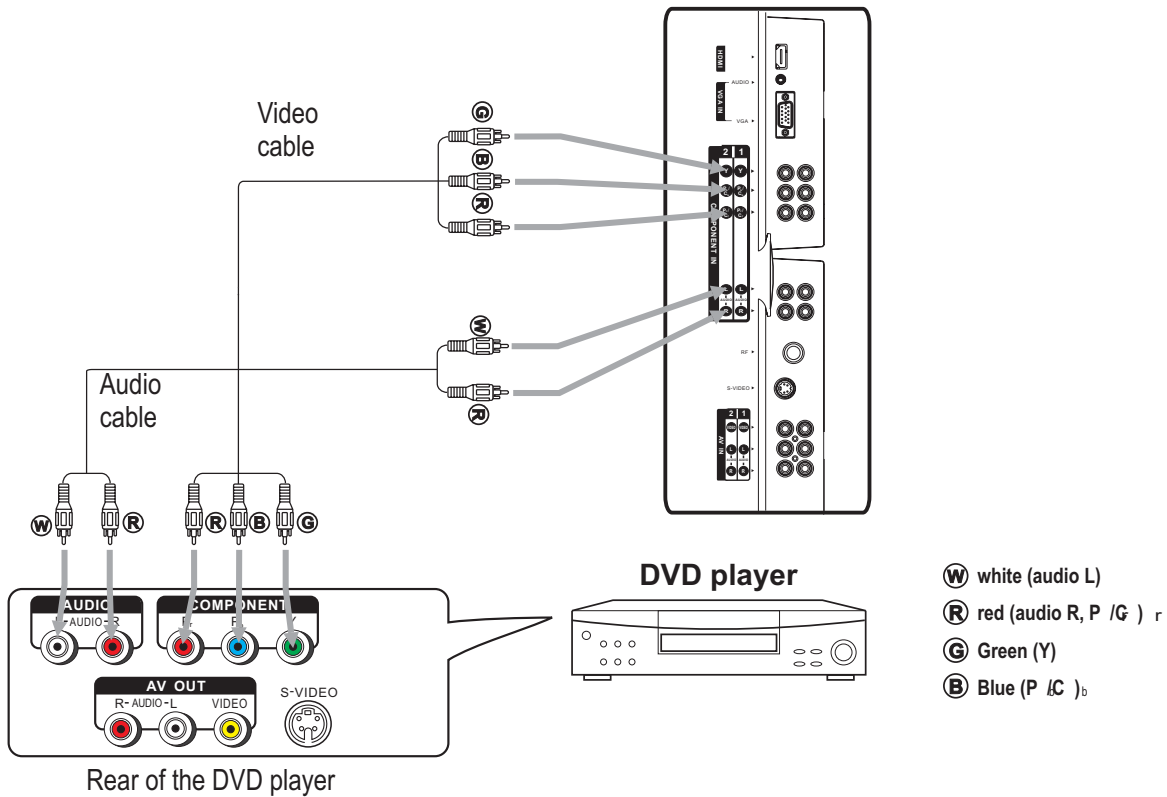

How to connect a DVD Player using Component Video Connections:

Connect the Video cable between the Y, Pb/Cb, Pr/Cr input jacks on the unit and Y, Pb, Pr (or Y, Cb, Cr) output jacks on the DVD player.

Connect the Audio cable between the AUDIO input jacks on the unit and AUDIO output jacks on the DVD player.

To play DVD

1. Turn on your LCD TV , press **INPUT** button on the remote control.
2. Press **INPUT** button repeatedly to select **YPBPR2**.
3. Turn on your DVD player, insert a DVD disc and press the Play button.

SOURCE

TV	AV1	AV2/SV	YPBPR1	YPBPR2	VGA	HDMI
----	-----	--------	--------	--------	-----	------

Note:

If you connect your external device with **COMPONENT IN (1)** terminals, please select **YPBPR1** correspondingly in source select menu.

Connect a product to HDMI

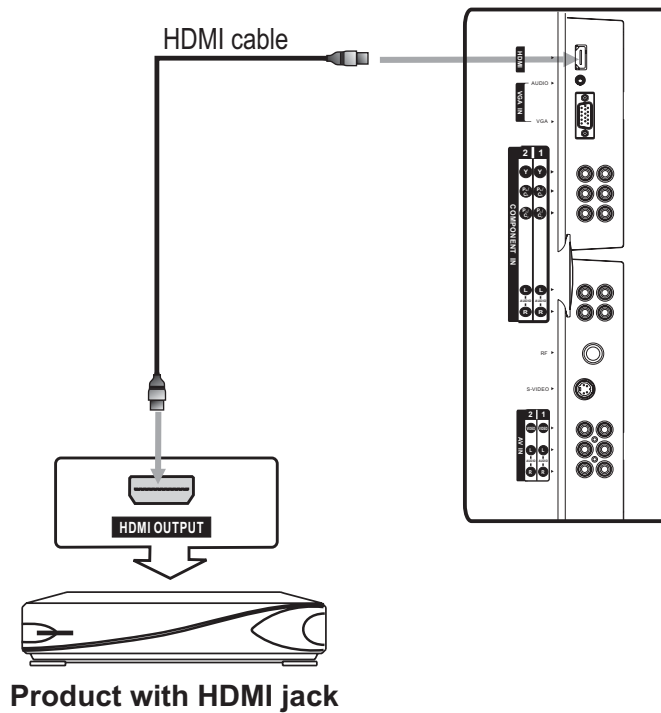

How to connect:

Connect the HDMI cable between the HDMI input jacks on the unit and HDMI output jacks on the product.

Note:

The HDMI Sources are compatible with DVI displays through the use of a passive cable converter. So you may connect product with DVI output jack to the unit.

Connect a passive cable converter between the HDMI input jack on the unit and DVI output jack on the product.

Connect an Audio cable between the AUDIO output on your product and AUDIO input jack of **VGA IN** on the unit.

To Watch your Product

1. Turn on your LCD TV , press **INPUT** button on the remote control.
2. Press **INPUT** button repeatedly to select **HDMI**.
3. Turn on your Product.

SOURCE

TV AV1 AV2/SV YPBPR1 YPBPR2 VGA **HDMI**

Connect a PC

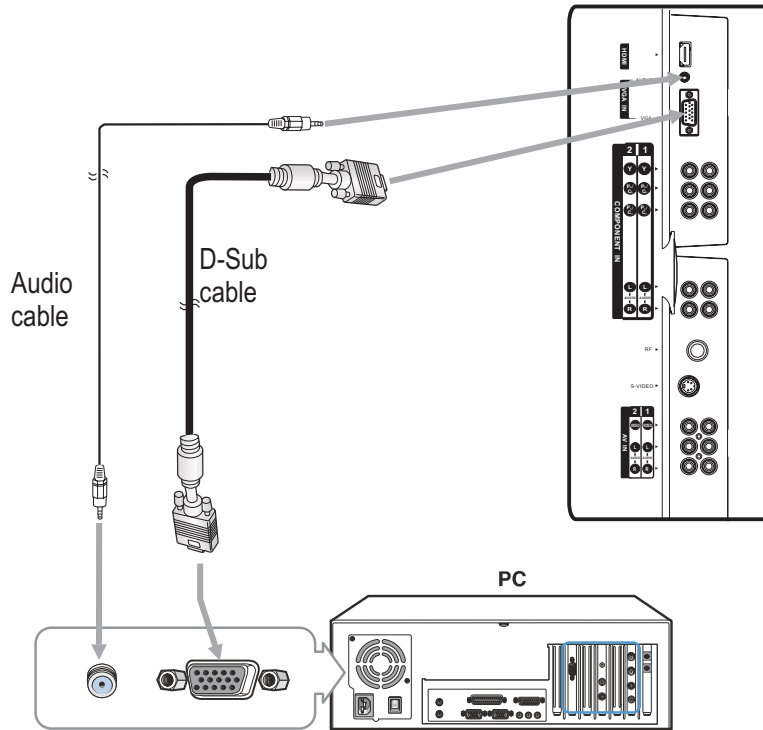

How to connect:

Connect a D-Sub cable between the VGA interface on the PC and the VGA input on the unit.

Connect an Audio cable between the AUDIO output on the PC and AUDIO input jack on the unit.

To Watch the PC screen

1. Turn on your LCD TV , press **INPUT** button on the remote control.
2. Press **INPUT** button repeatedly to select **VGA**.
3. Turn on your PC and check for PC system requirements.
4. Adjust the screen resolution and settings on your computer to the preferred settings.

SOURCE

TV AV1 AV2/SV YPBPR1 YPBPR2 **VGA** HDMI

Connect a VCR for Recording

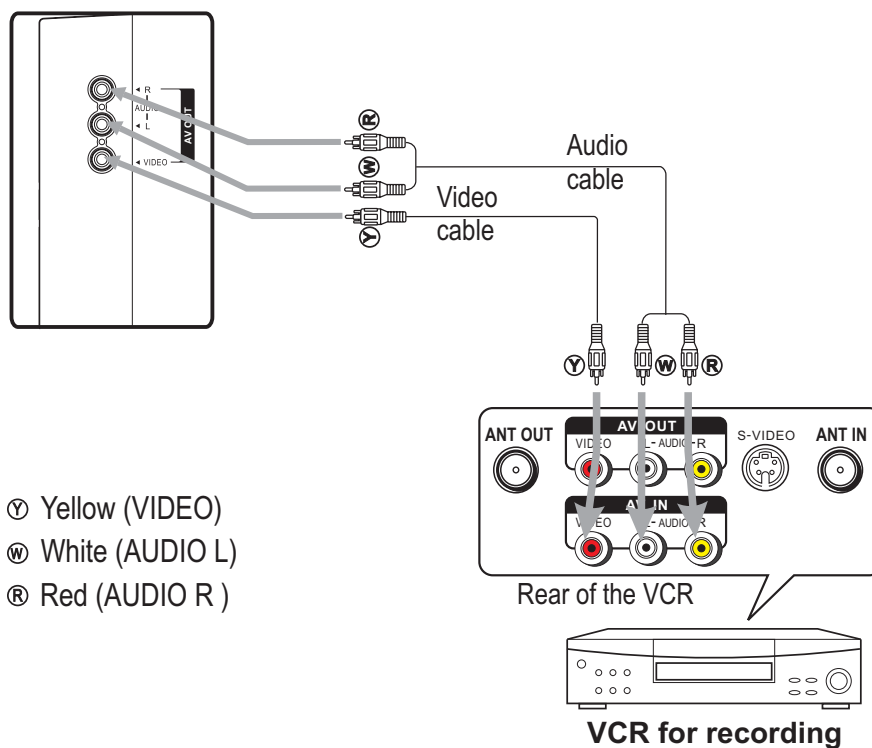

How to connect:

Connect the Audio/Video cables between the Audio (L/R)/Video jacks on the unit and VCR.

To record program

1. Turn on your LCD TV, select a program you wish to record.
2. Turn on your VCR, insert a videotape for recording.
3. Press the Record button to begin recording.

Note:

The AV output terminals output the audio/video signal from the Antenna input or AV inputs.

Turning the Unit On and Off

Turning On

Insert the power cord into the wall outlet.
Press the **Power** button on the remote control.
The unit will be turned on and you will be ready to use its features.

Turning Off

With the power on, Press the **Power** button on the remote control to turn off.

Note:

You can also use the **Power** button on the Control panel on the main unit.

Viewing the Menus and Displays

Your LCD TV has a simple, easy-to-use menu system that appears on the screen. This system makes it convenient and fast to use features on the unit. The unit also lets you display the status of many of your LCD TV features.

Viewing the Menus

- 1 With the power on, press the **MENU** button on the remote control. The main menu appears on the screen.



- 2 Use the ▲ ▼ to select menu item. Use ◀ ▶ to adjust value of item, use **OK** to confirm or enter submenu.
you can press the **MENU** button repeatedly to exit the menu operations.

Note:

To clearly introduce the menu operations, this operation manual provides a description based on operation with the remote control.

Displaying Status Information

Press the **DISPLAY** button on the remote control, the unit will display current status information such as channel number, audio mode or signal source, etc.

Memorizing the Channels

Your LCD TV can memorize and store all of the available channels for both air and cable channels. After the available channels are memorized, use CH+/- to scan through the channels.

Selecting the Signal Source

Before your LCD TV can memorize the available channels, you must specify the type of signal source that is connected to the unit. (i.e., an air or cable system)

- 1 Press **MENU** to display the menu main page.
- 2 Press **▲ ▼** repeatedly to select **SOURCE** menu.
- 3 Press **OK** to access the submenu.
- 4 Press **▼** repeatedly to select **ANTENNA** item.
- 5 Press **◀ ▶** to toggle between **AIR** or **CABLE**.
If you are connected to an antenna, please select **AIR**. If you connect cable, please select **CABLE**.
- 6 Press **MENU** repeatedly to exit.

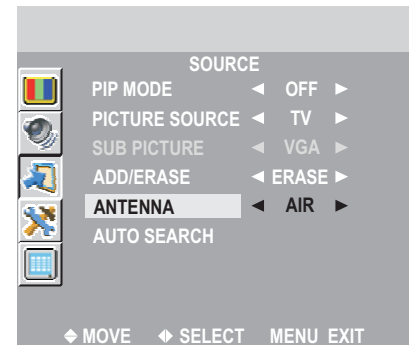
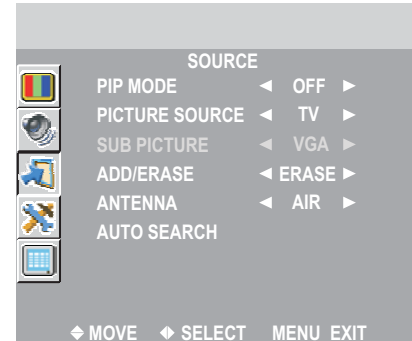

Storing Channels in Memory Automatically

- 1 Press **MENU** to display the menu main page.
- 2 Press **▲ ▼** repeatedly to select **SOURCE** menu.
- 3 Press **OK** to access the submenu.
- 4 Press **▼** repeatedly to select **AUTO SEARCH** item.
- 5 Press **◀ ▶** to store channels in memory automatically.
The unit will begin memorizing all of the available channels. During the process of the Auto Search, you can press **MENU** to exit.

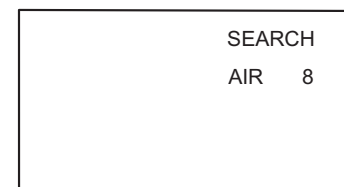
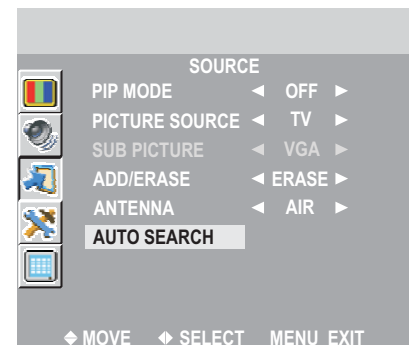

Adding and Erasing Channels

1 Use **number buttons** to directly select a channel that you want to add or erase.

2 Press **MENU** to display the menu main page.

3 Press **▲ ▼** repeatedly to select **SOURCE** menu.

4 Press **OK** to access the submenu.

5 Press **▼** repeatedly to select **ADD/ERASE** item.

6 Press **◀ ▶** to toggle between **ADD** or **ERASE** .

When the item is set to erase, the selected channel will be erased.
When the item is set to add, the selected channel will be added.

7 Press **MENU** repeatedly to exit.

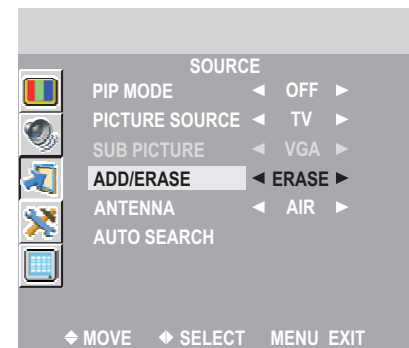

Changing Channels

Using the Channel Buttons (CH+ or CH-)

Press the **CH+** or **CH-** to change channels.

When you press the **CH+** or **CH-**, the unit changes channels in sequence. You will see all the channels that the unit has memorized. You will not see channels that were erased.

Direct Accessing Channels

Press the **number buttons** to go directly to a channel.

To select a one-digit channel: press the **0-9 number buttons** to input the channel number, followed by ENTER button or wait for some seconds, and the unit automatically goes to the selected channel.

To select a two-digit channel: press the **0-9 number buttons** to input the channel number and the unit goes to the selected channel.

To select a three-digit channel: press the **0-9 number buttons** to input the channel number and the unit goes to the selected channel (Only in CABLE mode).

Note:

When you use the number buttons, you can directly select channels that were erased.

Using the LAST button

Press this button to switch between the current channel and the previous channel.

Adjusting the Volume

Using the volume buttons (VOL+ and VOL-)

Press the **VOL +** or **VOL-** to increase or decrease the volume.

Using the Mute

Using the MUTE button

At any time, you can temporarily cut off the sound using the MUTE button.

- 1 Press the MUTE button and the sound cuts off.
- 2 To turn mute off, press the MUTE button again.

Select Input Source Signal

- 1 Press **MENU** to display the menu main page.
- 2 Press **▲ ▼** repeatedly to select **SOURCE** menu.
- 3 Press **OK** to access the submenu.
- 4 Press **▼** repeatedly to select **PICTURE SOURCE** item.
- 5 Press **◀ ▶** to select.
- 6 Press **MENU** repeatedly to exit.

TV -----Select TV signal.

AV1-----Select signal from AV IN(1) terminals.

AV2/SV-----Select signal from AV IN (2) or S-video terminals.

YPBPR1-----Select signal from YPbPr1 terminal.

YPBPR2-----Select signal from YPbPr2 terminal.

VGA-----Select signal from VGA jack.

HDMI ----Select signal from HDMI jack.

You can also use the **INPUT** button to select input source signal.

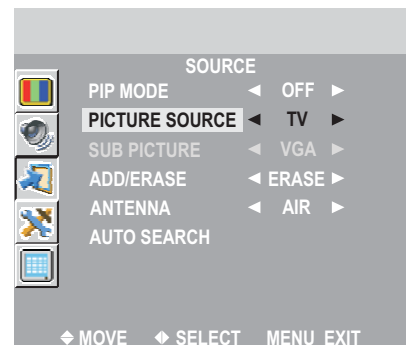
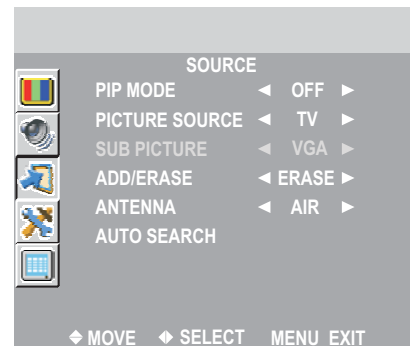

Selecting a Menu Language

- 1 Press **MENU** to display the menu main page.
- 2 Press **▲ ▼** repeatedly to select **OSD** menu.
- 3 Press **OK** to access the submenu.
The [LANGUAGE] item will be highlighted automatically.
- 4 Press **◀ ▶** to select a desired OSD language.
- 5 Press **MENU** repeatedly to exit.



Customizing the Picture

- 1 Press **MENU** to display the menu main page.
The picture menu page will be displayed automatically.
- 2 Press **OK** to access the **PICTURE** submenu.
- 3 Press **▲ ▼** to select the item you wish to change.
- 4 Press **◀ ▶** to adjust the value of the item.
- 5 Press **MENU** repeatedly to exit.

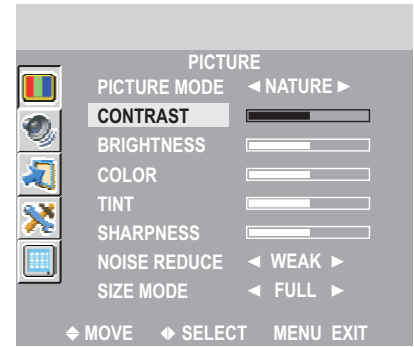

Using the Preset Picture Mode

- 1 Press **MENU** to display the **PICTURE** menu page.
- 2 Press **OK** to access the **PICTURE** submenu.
The [PICTURE MODE] will be highlighted automatically.
- 3 Press **◀ ▶** to select a desired picture mode.
- 4 Press **MENU** repeatedly to exit.



There are three preset picture modes (**BRIGHT**, **SOFT** and **NATURE**) and one user-set picture mode (**PERSONAL**). Each preset mode has its own picture settings.

BRIGHT: Select for a bright picture.

SOFT: Select for a finely detailed picture.

NATURE: Select for a normal picture.

Adjusted settings are stored in **PERSONAL** mode.

You may quickly use the **PICTURE MODE** button on the remote control to select picture mode.

Adjusting Screen Aspect

- 1 Press **MENU** to display the menu main page.
The picture menu page will be displayed automatically.
- 2 Press **OK** to access the submenu.
- 3 Press **▼** repeatedly to select **SIZE MODE** item.
- 4 Press **◀ ▶** to select a desired aspect ratio.
You may also use the **ASPECT** button to select the aspect ratio between **FULL**, **ZOOM1**, **ZOOM2** and **NORMAL**.

FULL — In this mode the picture is progressively stretched toward each side of the screen.

ZOOM1 — This feature is recommended for viewing "letter-box" movie (picture with a black bar on the top and bottom). If you watch a 4:3 picture in this mode, the picture will be expanded and some information at the top and bottom will be lost.

ZOOM2 — In this mode the picture is vertically stretched toward up side of the screen so that when viewing programs with title at the bottom, the bottom title can be revealed.

NORMAL — In this mode the picture is displayed without modification, in its native aspect ratio.

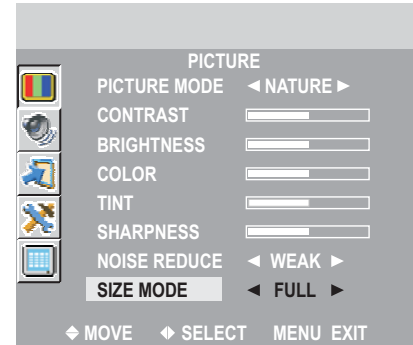

Reducing Picture Noise

- 1 Press **MENU** to display the menu main page.
The picture menu page will be displayed automatically.
- 2 Press **OK** to access the submenu.
- 3 Press **▼** repeatedly to select **NOISE REDUCE** item.
- 4 Press **◀ ▶** to select **OFF**, **WEAK** or **STRONG**.
Sometimes a noisy picture may appear on the screen because of poor signal.
This function helps to enhance the picture quality by reducing the noise.

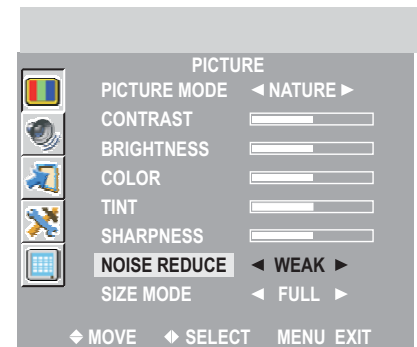

Setting Timer

Setting Clock Time

Making use of this function can set the current time for the TV.

- 1 Press **MENU** to display the menu main page.
- 2 Press **▲ ▼** repeatedly to select **FUNCTION** menu.
- 3 Press **OK** to access the submenu.
The [**CLOCK**] item will be highlighted automatically.
- 4 Press **OK** to access .
Use **▲ ▼** to set the hour (1-12) and the minute (00-59), use **◀ ▶** to switch between the hour and minute.
- 5 Press **MENU** repeatedly to exit.

NOTE:

Before setting the **TIME ON** and **TIME OFF**, please set the **CLOCK** item first.

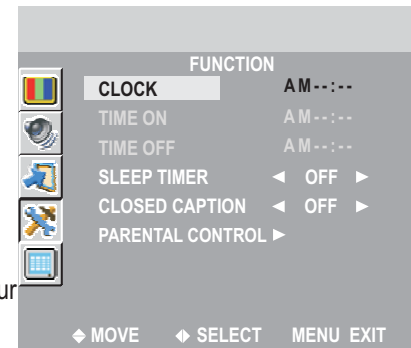

Setting ON timer

With the ON timer, the TV will automatically turn on at a preset time.

- 1 Press **MENU** to display the menu main page.
- 2 Press **▲ ▼** repeatedly to select **FUNCTION** menu.
- 3 Press **OK** to access the submenu.
- 4 Press **▼** repeatedly to select **TIME ON** item.
- 5 Press **OK** to access .
Use **▲ ▼** to set the hour (1-12) and the minute (00-59), use **◀ ▶** to switch between the hour and minute.
- 6 Press **MENU** repeatedly to exit.

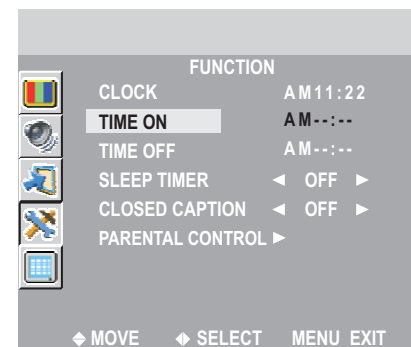

Setting OFF timer

With the OFF timer, the TV will automatically turn off at a preset time.

- 1 Press **MENU** to display the menu main page.
- 2 Press **▲ ▼** repeatedly to select **FUNCTION** menu.
- 3 Press **OK** to access the submenu.
- 4 Press **▼** repeatedly to select **TIME OFF** item.
- 5 Press **OK** to access .
Use **▲ ▼** to set the hour (1-12) and the minute (00-59), use **◀ ▶** to switch between the hour and minute.
- 6 Press **MENU** repeatedly to exit.

NOTE:

The time interval between **CLOCK** and **TIME OFF** should be above 1 minute. When the last 1 minute comes, there exit two situations. The one is: the unit will show you after how many seconds the set will be turned off. During this period if you do not want the unit to be turned off, press any button to exit before the unit turn off.

The other is: the OFF timer will be canceled automatically under certain conditions such as sound mute, picture freeze or other OSD items adjustment etc.

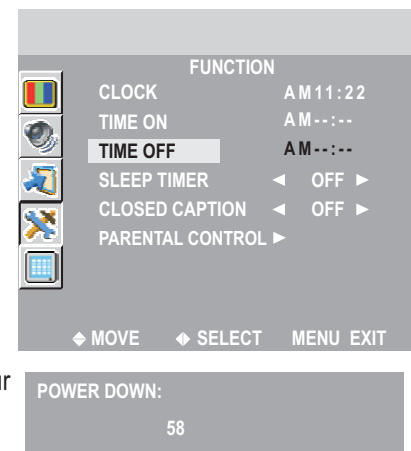

Setting Sleep Timer

Making use of this function allows you to have the set automatically turn off after a preset time.

- 1 Press **MENU** to display the menu main page.
- 2 Press **▲ ▼** repeatedly to select **FUNCTION** menu.
- 3 Press **OK** to access the submenu.
- 4 Press **▼** repeatedly to highlight **SLEEP TIMER** item.
- 5 Press **◀ ▶** repeatedly to select .
- 6 Press **MENU** repeatedly to exit.

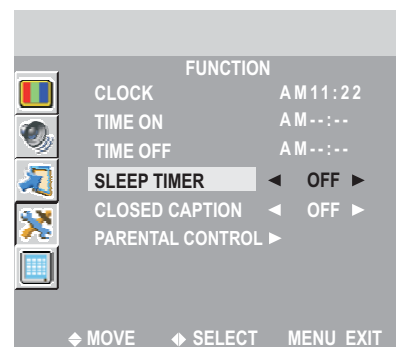

Note:

You may quickly set the sleep time by using the **SLEEP** button on the remote control.

Customizing the Sound

- 1 Press **MENU** to display the menu main page.
- 2 Press **▲ ▼** repeatedly to select **SOUND** menu.
- 3 Press **OK** to access the submenu.
- 4 Press **▼** repeatedly to select the option items you want to adjust.
- 5 Press **◀ ▶** to adjust the value .

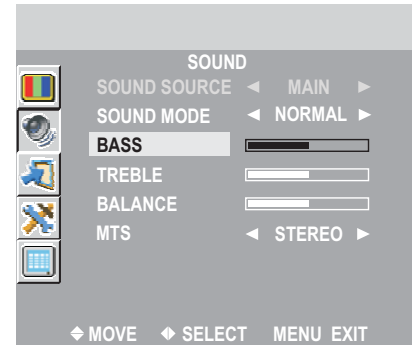

Using the Preset Sound Mode

- 1 Press **MENU** to display the menu main page.
- 2 Press **▲ ▼** repeatedly to select **SOUND** menu.
- 3 Press **OK** to access the submenu.
- 4 Press **▼** repeatedly to select **SOUND MODE** item.
- 5 Press **◀ ▶** to select a desired sound mode.



There are three preset sound modes (**NORMAL**, **MUSIC** and **NEWS**) and one user-set sound mode (**PERSONAL**). Each preset mode has its own sound settings (Bass and Treble).

NORMAL: Set the value of Bass and Treble to middle level.

MUSIC: Set the value of Bass and Treble to higher level.

NEWS: Set the value of Bass and Treble to lower level.

Adjusted settings are stored in **PERSONAL** mode.

You may directly use the **SOUND MODE** button to quickly select sound mode.

Selecting Stereo Mode

- 1 Press **MENU** to display the menu main page.
- 2 Press **▲ ▼** repeatedly to select **SOUND** menu.
- 3 Press **OK** to access the submenu.
- 4 Press **▼** repeatedly to select **MTS** item.
- 5 Press **◀ ▶** to select a desired stereo mode.

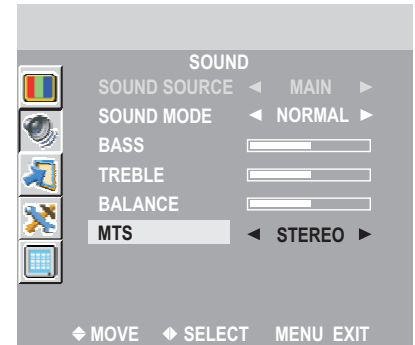

The relationships between Broadcast signal, User setting and Output are shown as follows:

Broadcast signal	User setting	Output
MONO	MONO	MONO
	STEREO	MONO
	SAP	MONO
STEREO	MONO	MONO
	STEREO	STEREO
	SAP	STEREO
SAP	MONO	MONO
	STEREO	MONO
	SAP	SAP
STEREO&SAP	MONO	MONO
	STEREO	STEREO
	SAP	SAP

MONO: monophonic audio STEREO: stereo audio SAP: second audio program

NOTE:

You may directly use the **STEREO** button to quickly select stereo mode. With every press of this button, the stereo mode changes as follows:

MONO ↔ STEREO (If the program is **STEREO**)

MONO ↔ SAP (If the program is **SAP**)

MONO → STEREO → SAP (If the program is **STEREO & SAP**)



Adjusting OSD Position

- 1 Press **MENU** to display the menu main page.
- 2 Press **▲ ▼** repeatedly to select **OSD** menu.
- 3 Press **OK** to access the submenu.
- 4 Press **▼** repeatedly to select **H-POSITION** or **V-POSITION** item.
- 5 Press **◀ ▶** to adjust the OSD position.

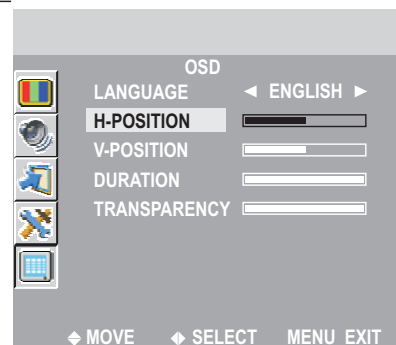

Adjusting OSD Transparency

- 1 Press **MENU** to display the menu main page.
- 2 Press **▲ ▼** repeatedly to select **OSD** menu.
- 3 Press **OK** to access the submenu.
- 4 Press **▼** repeatedly to select **TRANSPARENCY** item.
- 5 Press **◀ ▶** to adjust the OSD transparency.



Setting OSD Timeout

This setting allows you to set the time for the main OSD menu to be displayed on screen.

- 1 Press **MENU** to display the menu main page.
- 2 Press **▲ ▼** repeatedly to select **OSD** menu.
- 3 Press **OK** to access the submenu.
- 4 Press **▼** repeatedly to select **DURATION** item.
- 5 Press **◀ ▶** to adjust the value.

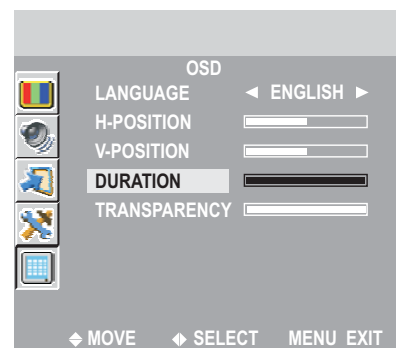

Viewing and Changing the Position of the PIP Frame

- 1 Press **MENU** to display the menu main page.
- 2 Press **▲ ▼** repeatedly to select **SOURCE** menu.
- 3 Press **OK** to access the submenu.
The [PIP MODE] item will be highlighted automatically.
- 4 Press **◀ ▶** repeatedly to select OFF, P1S1, P1S2, P2S1, P2S2, P3S1, P3S2, P4S1 or P4S2.
- 5 Press **MENU** to exit.

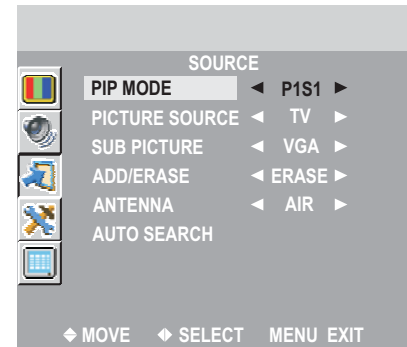

NOTE:

You may quickly open or close PIP frame by directly using the **PIP** button.
You may also change the position of the PIP frame and adjust the size by using **SIZE** button.

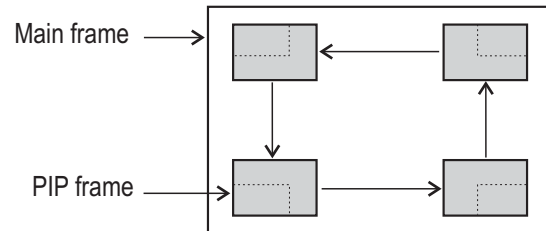

Selecting the Signal Source for the PIP Frame

- 1 With the PIP working, press **MENU** to display the menu main page.
- 2 Press **▲ ▼** repeatedly to select **SOURCE** menu.
- 3 Press **OK** to access the submenu.
- 4 Press **▼** repeatedly to select **SUB PICTURE** item.
- 5 Press **◀ ▶** to select signal source for the PIP frame.

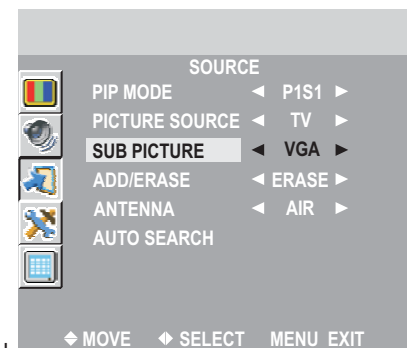

The input signal source are divided into two groups. One contains TV, AV1 and AV2/SV, the other contains YPBPR, VGA and HDMI.

If the input signal source selected for the main frame is one kind from one group, you may only allows to select a kind of input signal source for PIP frame from the other group.

Selecting Sound Source for PIP Frame

- 1 With the PIP working, press **MENU** to display the menu main page.
- 2 Press **▲ ▼** repeatedly to select **SOUND** menu.
- 3 Press **OK** to access the submenu.
The [SOUND SOURCE] item will be highlighted automatically.
- 4 Press **◀ ▶** to select between **MAIN** or **SUB**.
- 5 Press **MENU** to exit.

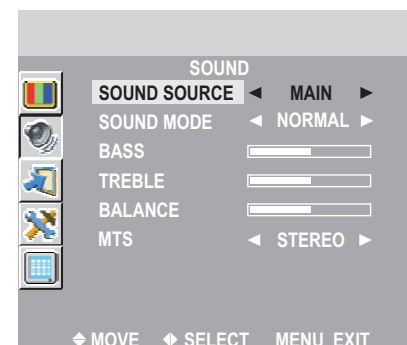

NOTE:

If you select **MAIN**, the main frame' sound will be output;
If you select **SUB**, the pip frame will be highlighted with a blue border and the sound will be output.
You may directly use the **PIP INPUT** button for selection.

Viewing Closed Captions

The unit decodes and displays the closed captions that are broadcast with certain TV shows. These captions are usually subtitles for the hearing impaired or foreign language translations. All VCRs record the closed caption signal from television programs, so home-recorded video tapes also provide closed captions. Most prerecorded commercial video tapes provide closed captions as well. Check for the closed caption symbol in your television schedule and on the tape's packaging: .

Note:

Not all the programs and videos will offer closed captioning. Please look for the  symbol to ensure that captions will be shown.

Setting Closed Caption

- 1 Press **MENU** to display the menu main page.
- 2 Press **▲ ▼** repeatedly to select **FUNCTION** menu.
- 3 Press **OK** to access the submenu.
- 4 Press **▼** repeatedly to select **CLOSED CAPTION** item.
- 5 Press **◀ ▶** repeatedly to select a desired mode.

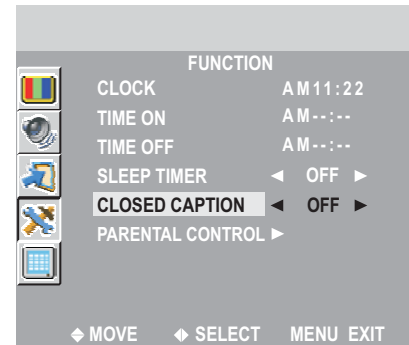

You may select between OFF, CC1, CC2, CC3, CC4, TEXT1, TEXT2, TEXT3, TEXT4 and ON MUTE.

The Closed Caption broadcasts can be viewed in two modes: CAPTION and TEXT. For each mode, four channels are available.

The [CAPTION] mode shows subtitles of dialogues and commentaries of TV dramas and news programs while allowing a clear view of the picture.

The [TEXT] mode displays various information over the picture (such as TV program schedule, weather forecast, etc.) that is independent of the TV programs.

If you select ON MUTE mode, when you press the **MUTE** button, CC1 mode caption will be displayed on screen.

Note:

You may quickly select CCD mode by using the **CAPTION** button directly.

Adjusting the Picture

- 1 Press **MENU** to display the menu main page.
The [PICTURE] menu will be highlighted automatically.
- 2 Press **OK** to access the submenu.
- 3 Press **▲ ▼** repeatedly to select the item you wish to change.
- 4 Press **◀ ▶** to adjust the value of the item.
- 5 Press **MENU** repeatedly to exit.

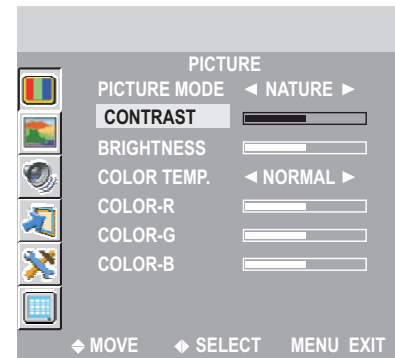

Adjusting Image Size

- 1 Press **MENU** to display the menu main page.
- 2 Press **▲ ▼** repeatedly to select **SCREEN** menu.
- 3 Press **OK** to access the submenu.
The [SIZE MODE] item will be highlighted automatically.
- 4 Press **◀ ▶** to select **FULL** or **ASPECT**.
- 5 Press **MENU** repeatedly to exit.

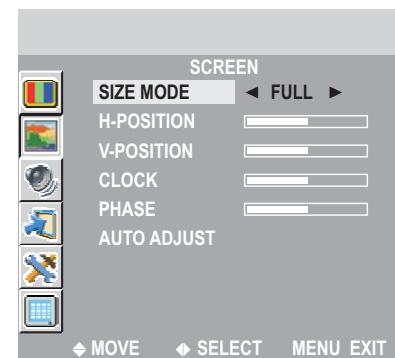

Changing the Position of Image

- 1 Press **MENU** to display the menu main page.
- 2 Press **▲ ▼** repeatedly to select **SCREEN** menu.
- 3 Press **OK** to access the submenu.
- 4 Press **▼** repeatedly to select **H-POSITION** or **V-POSITION** item.
- 5 Press **◀ ▶** to adjust the value of the item until the screen is well-aligned.
- 6 Press **MENU** repeatedly to exit.

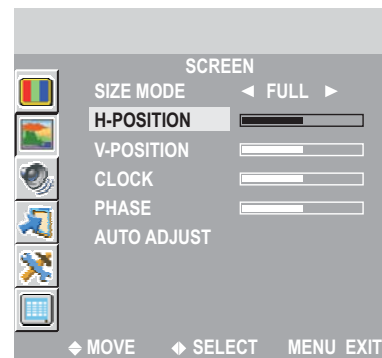

Adjusting the CLOCK and PHASE

- 1 Press **MENU** to display the menu main page.
- 2 Press **▲ ▼** repeatedly to select **SCREEN** menu.
- 3 Press **OK** to access the submenu.
- 4 Press **▼** repeatedly to select **CLOCK** or **PHASE** item.
- 5 Press **◀ ▶** to adjust the value of the item.
- 6 Press **MENU** repeatedly to exit.

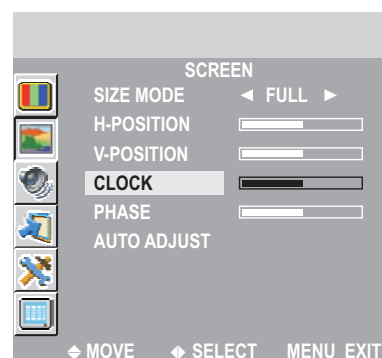

You may find that images blur, depending on the clock phase of your PC's Processor. If you experience blurring, you can obtain a clearer image by adjusting the phase item.

Adjust the clock frequency of the set's internal clock signal. If shimmering or rainbow-like noise is apparent in the image, try adjusting the clock frequency item.

Adjusting the Picture Automatically

If you are not satisfied with the picture, you may adjust the picture by using this function.

- 1 Press **MENU** to display the menu main page.
- 2 Press **▲ ▼** repeatedly to select **SCREEN** menu.
- 3 Press **OK** to access the submenu.
- 4 Press **▼** repeatedly to select **AUTO ADJUST** item.
- 5 Press **OK** to start adjusting.

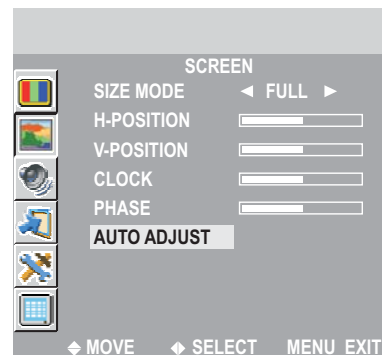

Parental Control

This function allows TV programs to be restricted and TV usage to be controlled based on FCC data. It prevents children from watching violent or sexual scenes that may be harmful.

Restriction of TV programs includes two ratings that contain information about the program: the MPAA rating and the TV Parental Guidelines. The MPAA rating is restricted by age. TV Parental Guidelines are restricted by age and content.

Since a TV program may use either the MPAA rating or the TV Guidelines, both should be adjusted for complete control.

[1] TV RATING

Rating		← content based →				
		D	L	S	V	FV
age based	TV-Y (All children)	×	×	×	×	×
	TV-Y7 (Direct to Older Children)	×	×	×	×	●
	TV-G (General Audience)	×	×	×	×	
	TV-PG (Parental Guidance Suggested)	●	●	●	●	
	TV-14 (Parents Strongly Cautioned)	●	●	●	●	
	TV-MA (Mature Audience Only)		●	●	●	

× ——— Content Rating can be set but this Rating is not normally broadcast by TV Station.

● ——— Content Rating can be set.

D: Sexually Suggestive Dialog

L: Adult Language

S: Sexual Situation

V: Violence

FV: Fantasy Violence

Note:

Age-based ratings can be modified by the content-based ratings but only in the combinations indicated by an in the table above. Choosing lower age-based rating blocks the higher age-based ratings regardless of content ratings settings.

Example 1:

When TV-Y7 in the age-based rating is set to BLOCK, this will automatically block the higher ratings: TV-G, TV-PG, TV-14 and TV-MA. In addition, D, L, S, V and FV in content are automatically blocked.

	FUNCTION	All	FV	V	S	L	D
TV-Y	U						
TV-Y7	B	B					
TV-G	B						
TV-PG	B		B	B	B	B	B
TV-14	B		B	B	B	B	B
TV-MA	B		B	B	B		

[B:BLOCK U:UNBLOCK]
USE PIP INPUT KEY TO BLOCK/UNBLOCK

◆ MOVE ◆ SELECT MENU EXIT

Example 2:

When TV-14 in the age-based rating is set to BLOCK, this will automatically block the higher ratings: TV-MA.

In addition, if you block "L" sub-rating in TV-PG, then the D, L, S, V and FV in content in TV-14 and TV-MA will automatically be blocked.

	FUNCTION	All	FV	V	S	L	D
TV-Y	U						
TV-Y7	B						
TV-G	B						
TV-PG	B		B	B	B	B	B
TV-14	B		B	B	B	B	B
TV-MA	B		B	B	B		

[B:BLOCK U:UNBLOCK]
USE PIP INPUT KEY TO BLOCK/UNBLOCK

◆ MOVE ◆ SELECT MENU EXIT

[2] MOVIE RATING (MPAA)

Rating		
age based	G	GENERAL AUDIENCES. All ages admitted.
	PG	PARENTAL GUIDANCE SUGGESTED. Some material may not be suitable for children.
	PG-13	PARENTAL STRONGLY CAUTIONED. Some material may be inappropriate for children under 13.
	R	RESTRICTED. Under 17 requires accompanying parent or adult guardian.
	NC-17	NO ONE 17 AND UNDER ADMITTED.
	X	X Rating is an older rating that is unified with NC-17 but may be encoded in the data of older movies.

Note:

The Movie rating is only age-based.

Example 1:

“PG-13” in the age-based rating is blocked, this will automatically block the higher ratings “R”, “NC-17”, “X” also.

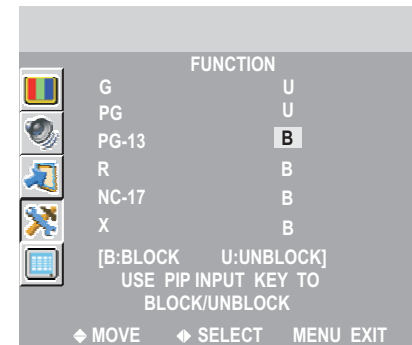

Example 2:

“R” in the age-based rating is blocked, this will automatically block the higher rating “NC-17”, “X” also.

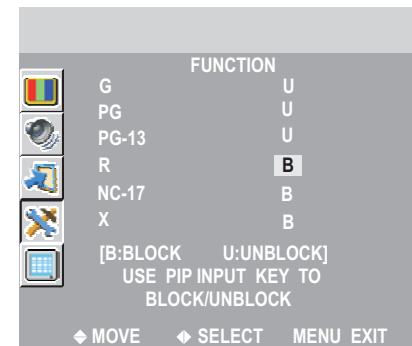

Accessing PARENTAL CONTROL

- 1 Press the **MENU** button to display the menu main page.;
- 2 Press **▲ ▼** repeatedly to select **FUNCTION** menu.
- 3 Press **OK** to access the submenu;
- 4 Press **▼** repeatedly to select **PARENTAL CONTROL** item;
- 5 Press **OK** to access and then the unit requires you to input password.
 Directly use 0~9 **number buttons** to input password.
 The default password is 0000, you can change the password by yourself.
 The unit allows you to access the **PARENTAL CONTROL** item if you input the right password, or you will be denied.

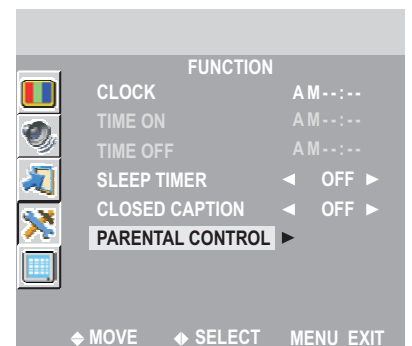

Changing the Password

- 1 After accessing the **PARENTAL CONTROL** menu, press **▼** repeatedly to select **CHANGE PASSWORD** item.
- 2 Press **OK** to access and then the unit requires you to input your new password. Directly use 0~9 number buttons to input and then confirm again.
- 3 Press **MENU** repeatedly to exit.
Be sure to write down your password and retain it for future use.

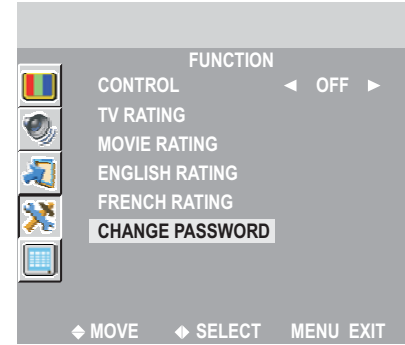

Turning PARENTAL CONTROL ON or OFF

- 1 After accessing the **PARENTAL CONTROL** menu, the **[CONTROL]** item will be highlighted automatically.
- 2 Press **◀ ▶** to select **ON** or **OFF**.
- 3 Press **MENU** repeatedly to exit.
NOTE:
Only when you set this item to **ON** does the settings of **PARENTAL CONTROL** works.

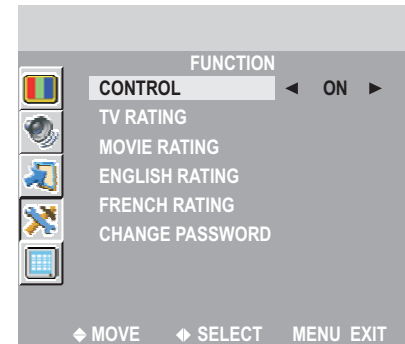

Adjusting the TV RATING

- 1 After accessing **PARENTAL CONTROL**, press **▼** repeatedly to select **TV RATING** item.
- 2 Press **OK** to access submenu.
- 3 Press **▲ ▼** repeatedly to select a desired rating you want to set and press **PIP INPUT** button to block or unblock.
This will automatically block the higher age-based ratings. You may set the individual content-based ratings as follow.
- 4 Press **◀ ▶** repeatedly to select a desired content rating.
- 5 Press **PIP INPUT** button to block or unblock this rating.
- 6 Press **MENU** repeatedly to exit.

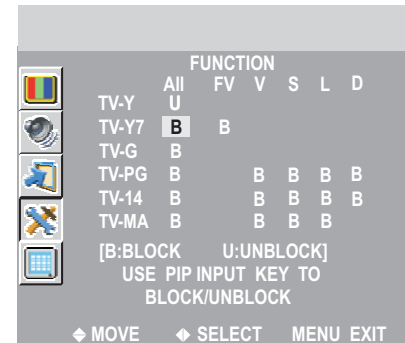

Adjusting the MOVIE RATING

- 1 After accessing **PARENTAL CONTROL**, press **▼** repeatedly to select **MOVIE RATING** item.
- 2 Press **OK** to access submenu.
- 3 Press **▲ ▼** repeatedly to select a desired rating you want to set.
- 4 Press **PIP INPUT** button to block or unblock this rating.
- 5 Press the **MENU** repeatedly to exit.

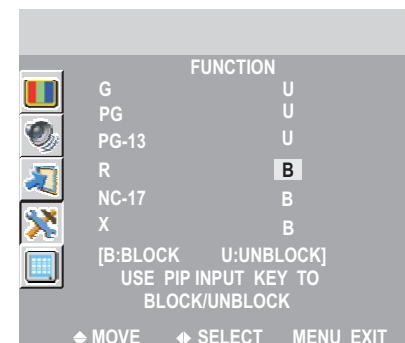

Adjusting ENGLISH RATING

- 1 After accessing **PARENTAL CONTROL**, press ▼ repeatedly to select **ENGLISH RATING** item.
- 2 Press **OK** to access submenu.
- 3 Press ▲ ▼ repeatedly to select a desired rating you want to set.
- 4 Press **PIP INPUT** button to block or unblock this rating .
- 5 Press the **MENU** repeatedly to exit.

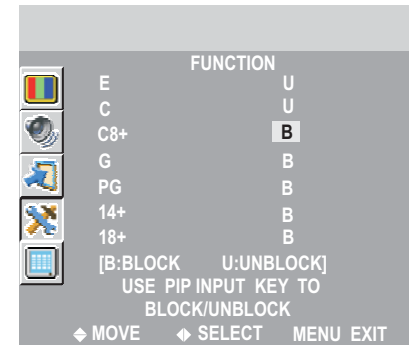

ENGLISH RATING CHART

E	Exempt - Exempt programming includes: news, sports, documentaries and other information programming, talk shows, music videos, and variety programming.
C	Programming intended for children under age 8. No offensive language, nudity or sexual content.
C8+	Programming generally considered acceptable for children 8 years and over. No profanity, nudity or sexual content.
G	General programming, suitable for all audiences.
PG	Parental Guidance suggested. Some material may not be suitable for children.
14+	Programming contains themes or content which may not be suitable for viewers under the age of 14. Parents are strongly cautioned to exercise discretion in permitting viewing by pre-teens and early teens.
18+	Intended for viewers 18 years and older and might contain depictions of violence.

Adjusting FRENCH RATING

- 1 After accessing **PARENTAL CONTROL**, press ▼ repeatedly to select **FRENCH RATING** item.
- 2 Press **OK** to access submenu.
- 3 Press ▲ ▼ repeatedly to select a desired rating you want to set.
- 4 Press **PIP INPUT** button to block or unblock this rating .
- 5 Press the **MENU** repeatedly to exit.

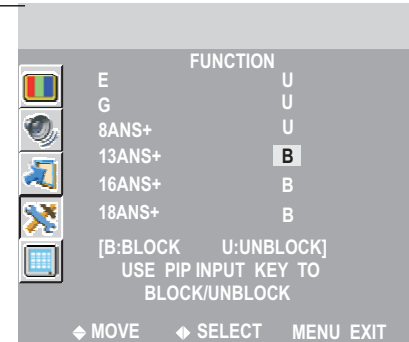

FRENCH RATING CHART

E	Exempt - Exempt programming.
G	General - Programming intended for audience of all ages. Contains no violence, or the violence content is minimal or is depicted appropriately.
8 ANS+	8+ General - Not recommended for young children. Programming intended for a broad audience but contains light or occasional violence. Adult supervision recommended.
13 ANS+	Programming may not be suitable for children under the age of 13 - Contains either a few violent scenes or one or more sufficiently violent scenes to affect them. Adult supervision strongly suggested.
16 ANS+	Programming may not be suitable for children under the age of 16 - Contains frequent scenes of violence or intense violence.
18 ANS+	Only for adult viewing. Could contain frequent violent scenes and extreme violence.

Troubleshooting

Before calling for repair service, check the following items for possible remedies to an encountered symptom.

Symptoms	Check item
"Ghost" or double images	<ul style="list-style-type: none">• This may be caused by obstruction to the aerial due to high rise buildings or hills. Using a highly directional aerial may improve the picture.
No power	<ul style="list-style-type: none">• Check that the AC power cord is plugged into the mains socket.• Unplug the power cord, wait for 60 seconds. Then re-insert plug into the mains socket and turn on the unit again.
No picture	<ul style="list-style-type: none">• Check aerial connections at the rear of the unit to see if it is properly connected to the unit.• Possible broadcast station trouble. Try another channel.• Adjust the contrast and brightness settings.• Select a correct input.• Is a non-compatible signal being input?
Good picture but no sound	<ul style="list-style-type: none">• Increase the VOLUME.• Check that the unit is not muted.
Good sound but poor colour	<ul style="list-style-type: none">• Adjust the contrast, colour and brightness settings.
Poor picture	<ul style="list-style-type: none">• Sometimes, poor picture quality occurs when having activated an S-VHS camera or camcorder connected and having connected another peripheral at the same time. In this case, switch off one of the other peripherals.• Check whether the room is too bright
Horizontal dotted line	<ul style="list-style-type: none">• This may be caused by electrical interference (e.g. hairdryer, nearby neon lights, etc.)• Turn off the equipment.
Television not responding to remote control	<ul style="list-style-type: none">• Check whether the batteries are working. Replace if necessary.• Clean the remote control sensor lens on the unit.• Do not use the remote control under strong or fluorescent lighting.• The batteries should be inserted with polarity (+, -) aligned.
Snowy picture and noise	<ul style="list-style-type: none">• Check the aerial connection.
No stable or not synchronized D-Sub picture	<ul style="list-style-type: none">• Check if you have selected the correct D-Sub mode in your PC.
No output from one of the speakers	<ul style="list-style-type: none">• Adjust Balance in the SOUND menu.
Control buttons do not work	<ul style="list-style-type: none">• Unplug the power cord, wait for some seconds. Then re-plug the power cord and turn on the unit again.

Do not use in hot and cold rooms (locations)

- When the unit is used in rooms (locations) with low temperature, the picture may leave trails or appear slightly delayed. This is not a malfunction, and the unit will recover when the temperature returns to normal.
- Do not leave the unit in a hot or cold location. Also, do not leave the unit in a location exposed to direct sunlight or near a heater, as this may cause the cabinet to deform and the LCD panel to malfunction.
(Storage temperature: 0°C to +50°C Working temperature: 5°C to +40°C)

Note:

If your problem is not solved, restart your TV by turning it off and then on again once.
Never attempt to repair a defective TV yourself.

Specification

Type:	LCD TV
Display Size diagonal:	32"
Power Supply:	AC100-240V 50/60Hz
Power Consumption:	140W
Dimensions(inch):	39.5 (W) X 24.9 (H) X 10.1 (D)
Unit Weight(lbs):	50.6 lb

Receiving channel:

VHF	2-13
UHF	14-69
CATV	2-69, (A-6)-(A-1), A-W, (W+1)-(W+28)
Total	181 channels

TV system: NTSC-M

 Design and specifications are subject to change without notice.

For service, support and warranty information, visit www.pwwservice.com or call 1-866-396-6322.

"Polaroid" and "Polaroid and Pixel" are trademarks of Polaroid Corporation, Waltham, MA, USA.



PRINTED IN
RECYCLED PAPER

604-L26U253-00
Ver. 1.0

Free Manuals Download Website

<http://myh66.com>

<http://usermanuals.us>

<http://www.somanuals.com>

<http://www.4manuals.cc>

<http://www.manual-lib.com>

<http://www.404manual.com>

<http://www.luxmanual.com>

<http://aubethermostatmanual.com>

Golf course search by state

<http://golfingnear.com>

Email search by domain

<http://emailbydomain.com>

Auto manuals search

<http://auto.somanuals.com>

TV manuals search

<http://tv.somanuals.com>