

5.6" Portable DVD Player

Model: PDV-0560M

Operations Manual



20040917

Contents

Important Safety Instructions	3
Characteristic Features	5
Disc Information	6
Description-DVD Player	7
Remote Control	9
Use of Remote Control.....	9
Remote Control Drawing.....	10
System Connections	12
Connecting to TV.....	12
Connecting to Amplifier.....	12
Connecting to Audio/Video Sources.....	13
Connecting to Power Adapter.....	13
Connecting to Car Adapter.....	14
Connecting to Headphone.....	14
About Rechargeable Battery	15
Usage of the rechargeable battery.....	15
Detaching the rechargeable battery.....	16
Disc Play Operations	17
Basic operation.....	18
DVD Playback.....	18
CD Playback.....	19
MP3 Playback.....	19
JPEG Playback.....	20
Playback Functions	21
System Setup	23
Carrying Case	29
Troubleshooting	32
Specifications	33

Important Safety Instructions

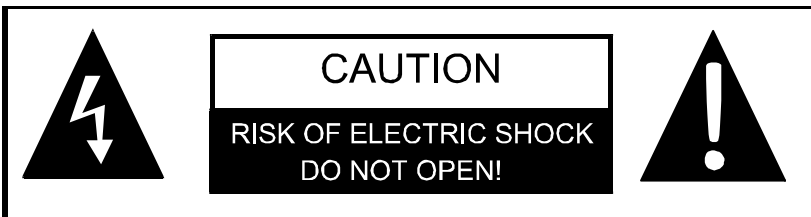

CAUTION: TO REDUCE THE RISK OF ELECTRIC SHOCK, DO NOT REMOVE COVER (OR BACK). NO USER SERVICEABLE PARTS INSIDE. REFER SERVICING TO QUALIFIED SERVICE PERSONNEL.



The lightning flash with arrowhead symbol, within an equilateral triangle, is intended to alert the user to the presence of uninsulated “dangerous voltage” within the product’s enclosure that may be sufficient to constitute a risk of electric shock to persons.



The exclamation point within an equilateral triangle is intended to alert the user to the presence of important operating and maintenance (servicing) instructions in the literature accompanying the appliance.

WARNING: TO REDUCE THE RISK OF FIRE OR ELECTRIC SHOCK, DO NOT EXPOSE THIS APPLIANCE TO RAIN OR MOISTURE.

POWER SUPPLY:

Connect the supplied adapter to the side of the attached LCD display in the slot marked with “DC12V In”. Use the supplied power cord to connect the jack marked “DC12V Out” on the side of the attached LCD screen and the jack marked with “DC12V In” on the side of the player, then plug the two-prong end of the power cord to an AC100-240V outlet. If you have difficulty inserting the plug, turn it over and reinsert it. If the unit will not be used for a long time, disconnect the plug from the outlet.

NOTE:

Before plugging the power cord into an AC outlet, make sure that all the connections have been made.

CAUTION: These servicing instructions are for use by qualified service personnel only. To reduce the risk of electric shock, do not perform any servicing other than that contained in the operating instructions unless you are qualified to do so. Refer to service manual for servicing instructions.

Important Safety Instructions

1. Read these instructions.
2. Keep these instructions.
3. Heed all warnings.
4. Follow all instructions.
5. Do not use near water.
6. Clean only with dry cloth.
7. Do not block any ventilation

IMPORTANT FOR LASER PRODUCTS

1. CLASS 1 LASER PRODUCT
2. **DANGER:** Visible laser radiation when open and interlock failed or defeated. Avoid direct exposure to beam.
3. **CAUTION:** Do not open the top cover. There are no user service-able parts inside the unit. Leave all servicing to qualified service personnel.

This unit complies with FDA regulation for radiation control of laser products.

- openings. Maintain well ventilated conditions around the product. Do not put product on bed, sofa or anything that blocks ventilation. Install in accordance with the manufacturer's instructions.
8. Do not install near any heat sources such as radiators, heat registers, stoves, or other apparatus (including amplifiers) that produce heat.
 9. Do not defeat the safety purpose of the polarized. A polarized plug has two blades with one wider than the other. If the provided plug does not fit into your outlet, consult an electrician for replacement of the obsolete outlet.
 10. Protect the power cord from being walked on or pinched particularly at plugs, convenience receptacles, and the point where they exit from the apparatus.
 11. Only use attachments/accessories specified by the manufacturer.
 12. Use only with the cart, stand, tripod, bracket, or table specified by the manufacturer, or sold with the apparatus. When a cart is used, use caution when moving the cart/apparatus combination to avoid injury from tip-over.
 13. Unplug this apparatus during lightning storms or when unused for long periods of time.
 14. Refer all servicing to qualified service personnel. Servicing is required when the apparatus has been damaged in any way, such as power-supply cord or plug is damaged, liquid has been spilled or objects have fallen into the apparatus, the apparatus has been exposed to rain or moisture, does not operate normally, or has been dropped.
 15. Apparatus shall not be exposed to dripping or splashing and no objects filled with liquids, such as vases, shall be placed on the apparatus.

Copyright Protection

Unauthorized copying, broadcasting, public performance, and lending of disks are prohibited. This product incorporates copyright protection technology that is protected by method claims of certain U.S. patents and other intellectual property rights owned by Macrovision Corporation and other rights owners. Use of this copyright protection technology must be authorized by Macrovision Corporation, and is intended for home and other limited viewing uses only unless otherwise authorized by Macrovision Corporation. Reverse engineering or disassembly is prohibited.

Characteristic Features

About this player

This player incorporates a DVD player, color LCD screen display, 2 channel stereo audio output functions.

When used in a vehicle, this player can be powered with the 12VDC car adapter.

High Quality Properties

High Resolution

MPEG2 decoding format achieves more than 500 lines of horizontal resolution.

Excellent Sound

Build-in Dolby decoder to output digital audio signal for high quality sound reproduction.

Screen

5.6" Color TFT LCD screen presents a high resolution picture and supports 4:3 aspect ratios.

Special Functions

Supports multi-angle and extra language caption.

Video Out

Standard video output.

Audio Out

Audio output terminal for connection to audio amplifiers.

ESP Function

Built-in electronic shock protection (ESP) circuitry.

AV Function

This player can be connected to external AV inputs.

Advanced Features

Compatibility

Plays DVD, CD, CD-R, CD-RW, PICTURE CD and MP3 discs.

Particular Performance

Multi-speed, fast forward, fast backward, slow play and repeat playback.

Search By Time



Search for a certain time on a disc.

Last Memory Playback

In power on status, memorizes and continues playing from place stopped (only available for DVD, CD disc).

Disc Information

Disc Formats Supported By This Player

	DISC LOGO	DIAMETER	PLAYBACK TIME/ PLAYABLE SIDES
DVD		12cm	133 min (SS-SL)
			242min (SS-DL)
			266min (DS-SL)
			484 min (DS-DL)
CD		12cm	74min
		8cm	20min
MP3		12cm	600min

The operating method of some DVD discs is specified by the software maker. Please refer to the instruction manual of the disc. The DVD player will play most recordable (CD-R) or erasable (CD-RW) CDs, but playback of CD-R or CD-RW discs created on a computer requires proper formatting and finalization of the disc for audio playback. Some computers and/or software programs may not be capable of creating compatible discs.

Care of Discs

- Do not touch the playing surface of the compact disc.
- Do not stick paper or labels on the disc.



Cleaning of Discs

If a disc has fingerprints or dust on it, lightly wipe the disc with soft cloth (or similar) from the center of the disc outward in a radial manner.



Storage of Discs

- Do not expose discs to direct sunlight.
- Do not place discs near water or in dusty place.

Never use record cleaning sprays, benzene, thinner, static electricity prevention liquids or any other solvents to clean your discs.

Description DVD Player

Front View

Open the cover to view the fashionable design of the unit:

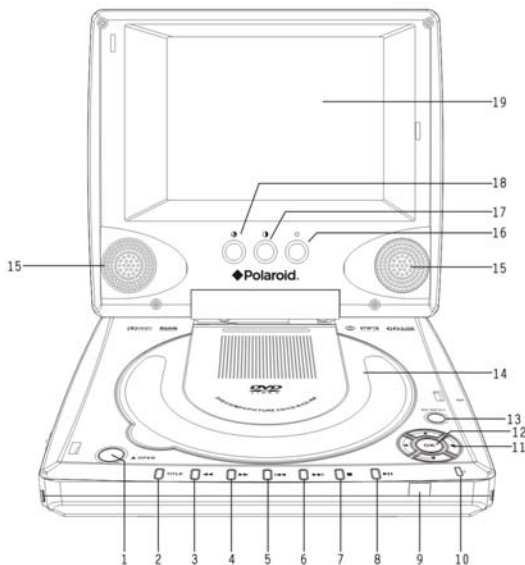

1. OPEN button

Press to open the disc tray.

2. TITLE button

Press to display title menu (if present) on the disc.

3. ◀◀ REV button

Press to search backward.

4. ▶▶ FWD button

Press to search forward.

5. ◀◀ PREV SKIP button

Press to return to the previous menu or chapter/track.

6. ▶▶ NEXT SKIP button

Press to skip to the next menu or next chapter/track.

7. ■ STOP button

Press to stop playback.

8. ▶|| PLAY/PAUSE button

Press once to pause playback. Press again to resume playback.

9. Remote sensor

Receives the signal from the remote control.

10. Indicators

During DVD playback, lights green. Under standby mode, lights red.

11. Direction buttons (◀ ▲ ▼ ▶)

Use ◀ ▲ ▼ ▶ buttons to select menu items.

Description-DVD Player

12. OK button

Press to confirm selections in the menu.

13. MENU button

Press to turn the menu on/off.

14. Disc tray cover

Press the OPEN button to open the tray for loading disc.

15. Speakers

Produce high quality sound.

16. Bright adjusting button

Press to adjust the brightness of the LCD screen.

17. Contrast adjusting button

Press to adjust the contrast of the LCD screen.

18. Color adjusting button

Press to adjust the color of the LCD screen.

19. LCD screen

Designed with TFT LCD display, clearly show the data on discs.

Left View



1. Headphone input jack

Connection for the headphone. When the headphone is plugged in, the built-in speakers will be turned off.

2. POWER ON/OFF switch

Switch the power of the player on or off.

Right View

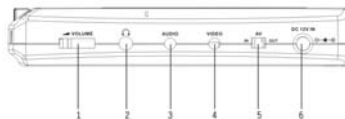

1. Headphone/speaker volume knob

Use to adjust the volume of the headphone and speakers.

2. Headphone jack

Connection for the headphone. When the headphone is plugged in, the built-in speakers will be turned off.

3. Audio input/output jack

Under AV IN mode, this jack is for audio input.

Under AV OUT mode, this jack is for audio output.

4. Video output/input jack

Under AV IN mode, this jack is for video input.

Under AV OUT mode, this jack is for video output.

5. AV 'IN' and AV 'OUT' Switch

Switch to AV "IN" position to put the unit into audio/video input mode.

Switch to AV "OUT" position to put the unit into audio/video output mode.

6. Direct current input jack

12V DC power input socket.

Remote Control

Use Of Remote Control

Preparation of remote control

Remove the battery compartment in the direction of the arrow. Place the lithium battery in the battery compartment. Make sure the polarity matches the marks inside the compartment. Insert the compartment into the remote.

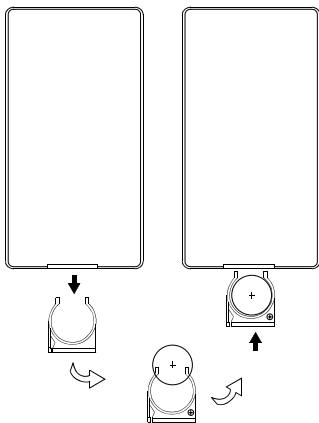

Under normal use the battery will last for about one year. If the remote control unit fails to work even when it is operated near the player, replace the battery. Take out the battery when the remote is not used for a long time.

Correct use of the Remote Control

Point the remote control at the unit from no more than about 5 feet from the remote control sensor and within about 60 degrees of the front of the unit. Do not place objects between the remote control unit and the remote control sensor.

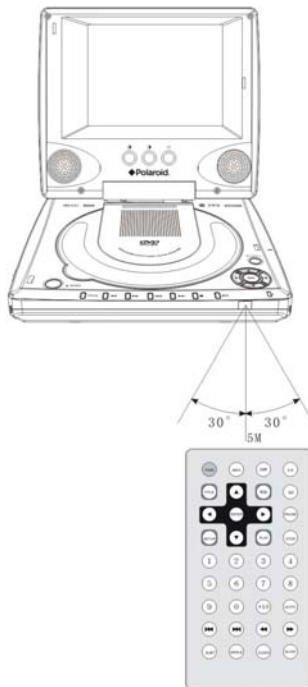

Remote Control

Remote Control Drawing

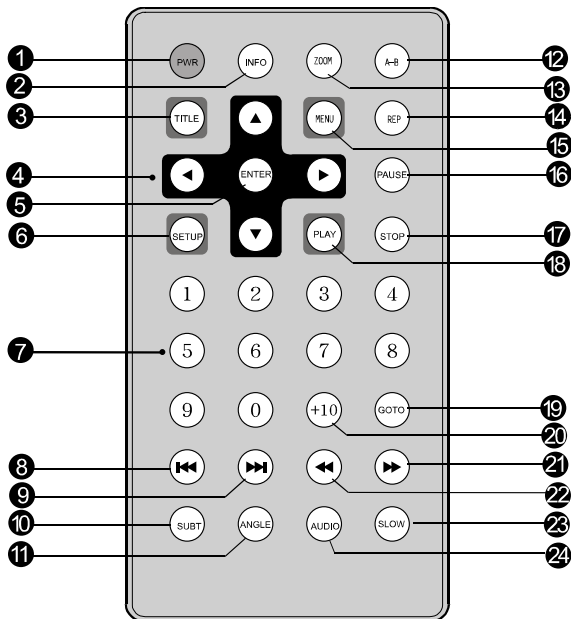

1. POWER button

Press to put the unit into standby mode.
Press again to put the unit into working mode.

2. INFO button

Press for detailed information on the disc playing.
Press repeatedly to remove information from screen.

3. TITLE button

Press to display title menu if present on the disc.

4. Direction buttons (▲ ▼ ◀ ▶)

Use ▲ ▼ ◀ ▶ to select menu items.

5. ENTER button

Press to begin the playback.
Press to confirm the items or setting.

6. SETUP button

Press to access the DVD player's setup menu.

7. 0-9 number buttons

Select track numbers.

Remote Control

8. ⏮ PREV button

Press to skip to the previous track/chapter.

9. ⏭ NEXT button

Press to skip to the next track/chapter.

10. SUBT button

When a DVD is playing, press to select a subtitle language or the turn subtitle off.

11. ANGLE button

Press to access various camera angles, if the DVD disc contains multiple camera angles.

12. A-B button

Press to mark a segment to repeat between A and B.

13. ZOOM button

Press to cycle through zoom function.

14. REP button

Press to repeat a track, chapter, title or all content.

15. MENU button

Press to turn of/off the menu.

16. PAUSE button

Press to pause playback.
Press the PLAY button to resume normal playback.

17. STOP button

Press once to stop playback and then press the PLAY button to resume normal playback.

Press the button twice to stop playback completely.

18. PLAY button

Press to begin playback.

19. GOTO button

Press to select the desired disc starting time, chapter or title.

20. +10 button

Select track numbers greater than 9.

21. ⏩ FWD button

Press to search forward.

22. ⏪ REV button

Press to search backward.

23. SLOW button

Press to activate slow forward or slow rewind.

24. AUDIO button

Press to access various audio Languages, if the DVD disc contains multiple audio languages.

System Connections

Do not connect the power to the unit until all audio and video connections have been made. Switch AV IN/OUT to AV/OUT mode for playing discs. Connect the audio/video output jacks to the corresponding jacks on the TV, amplifier or speaker.

Connecting to TV

Connections should be made as follows:

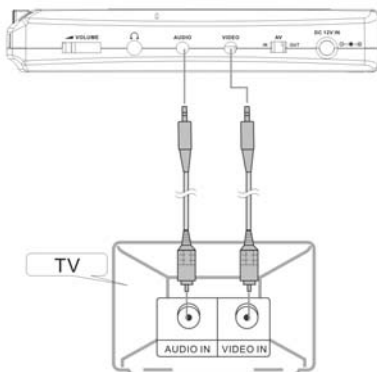

Connecting to an Amplifier

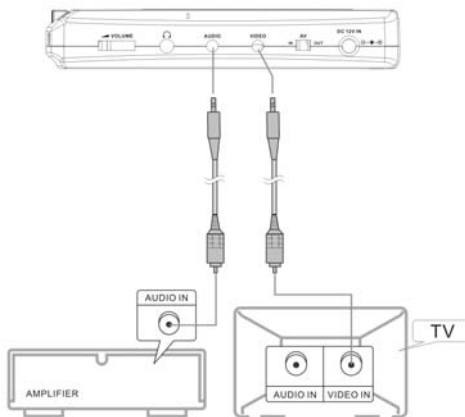

System Connections

Connecting to Audio/Video Sources

Move the switch "AV IN/OUT" to "IN" position on the right panel to put the unit into audio/video input mode.

Use the audio cable to connect the AUDIO socket of your DVD player with the audio output socket of external AV signal source.

Put one plug of the video cable into the VIDEO socket at the player's side. Put the other plug into the video output socket of external AV signal source.

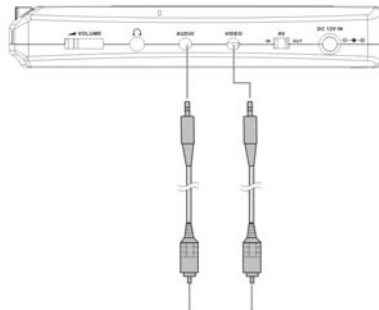

AV SIGNAL SOURCE

Connecting to Power Adapter

The player is supplied with a switching power adapter. Connections should be made as follows:

- Connect the rabbit joint end of the AC adapter to the power cord. Connect the AC adapter to the side of the DVD player in the slot marked "DC+12V". Plug the power cord into an electrical socket. See the below figure:

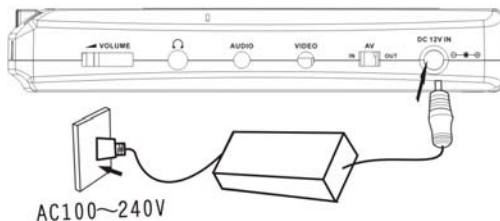

System Connections

Connecting To Car Adapter

You can use Car Adapter in a vehicle:

1. This player can be powered with a car adapter. (The car adapter is included)
2. Connect the Car Adapter Power Plug into the unit's Power Jack and the other end into the Vehicle Cigarette Lighter Socket:

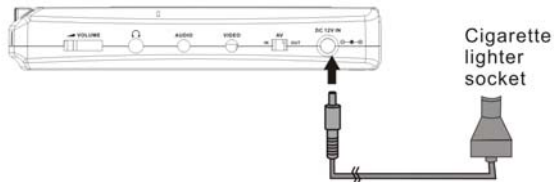

Note: Make sure the unit and the car adapter are not connected when starting the car. Do not leave the battery attached when using the car adapter.

Connecting To Headphones

Plug the headphone connector into the headphone jack on the right side of the DVD player. See the below figure:

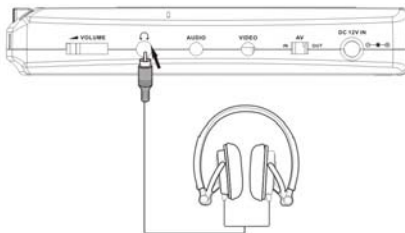

- Excessive loud usage of headphones could damage your hearing.
- Turn down the volume before you connect the headphones and then raise the volume to suit your level.
- When the headphone is plugged in, the unit's external speakers will be turned off.

About Rechargeable Battery

Normally the player is powered by connecting it to an AC power supply using the adapter. When used as a portable player outdoors or when traveling, the unit comes with a lithium ion rechargeable battery that attaches to the bottom of the player. You can enjoy the DVD player wherever you are.

Usage of the Rechargeable Battery

1. Turn the player upside down on a smooth, clean surface. Fit the battery so that the battery contacts and the five plastic tabs are aligned with the matching contacts and tab recesses on the player.
2. With one hand on the player to prevent it from moving, push the battery pack on to the player then slide the Battery Pack toward the front of the player until you hear it click and lock into place.
3. Plug the Power Adapter into the player's DC-IN 12 V Jack (located on Right Side of player). Plug the other end of the Power Cord into a household wall power outlet.

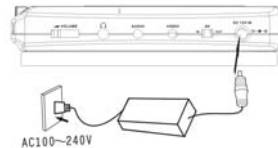
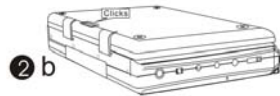

4. The properties of the rechargeable battery are: 7.4 Volts, with a capacity of 2300mAh, interior lithium ionic electric protection for recharge and discharge.
5. A fully charged battery will play a DVD with the LCD screen on for about 2 hours.
6. If the battery loses power, an indication on the screen will warn you. When this happens, switch off the player. Otherwise, the player will turn off automatically within a few seconds.
7. If the battery is not used, it will discharge gradually in about a month.
8. Charging time is normally about 4 hours.

About Rechargeable Battery

Detaching Battery Pack

Important Note: Detach battery when not in use for an extended period of time to prolong the battery's service life.

1. Press the tab towards the front of the unit.
Hold the tab in the up position.
2. Gently slide the Battery Pack toward the back of the Unit.
Carefully lift the Battery Pack from your player.

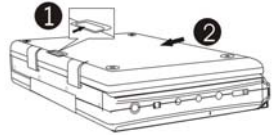

Working conditions and precautions

New batteries should be fully charged before initial use.

If you don't plan on using the battery for an extended period of time and keep it in a dry and cool place.

Battery should only be used and charged when temperatures are between 32-95F.

Maintain well-ventilation conditions around the product, avoid heat.

Never heat the battery or put the battery in fire.

Never put the battery in water.

Don't use metal to link positive pole to negative.

Do not open the battery. Refer servicing to qualified personnel.

Do not charge the battery pack more than 8 hours as it could reduce its service life.

Detach the battery pack when not in use.

Disc Play Operations

Basic operation

Preparation

After the connections have been made, turn on the relevant equipment and select the desired video input before playback.

Open the LCD screen

Press the button on the main panel, lift the LCD screen upward.

Turn on the player's power

Turn on the player's power by switching the POWER switch on the side of the player to "ON". When power is on, the player will search the disc automatically, if there is a disc loaded, the player will start to play it automatically.

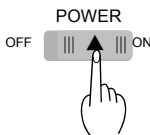

Press OPEN button on front panel to open the disc cover.



Load the disc into the disc tray with the label side up, see the figure below.

Load the disc as shown in order not to damage the player or the disc.



Close the disc tray cover so that it clicks. Playback will start automatically. During DVD playback, depending on discs, it will start playback directly or there will be a DVD menu or title menu displayed on the screen.

During CD disc playback, the unit will play the tracks in sequence.

Disc Play Operations

During playback, press the COLOR, CONTRAST and BRIGHT buttons on the front panel of the DVD player to adjust the picture.

During playback, rotate the earphone/speaker volume knob to increase and decrease the volume.

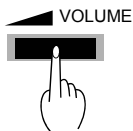

To interrupt playback press the STOP button once.



Press the OPEN button on the front panel to open the cover and take out the disc. Switch the POWER switch to the OFF position. (Turn off the relevant power supply)

Warning: Bad quality discs may damage the lens.

DVD PLAYBACK

Region Code

This player is designed and manufactured to respond to the region management information that is recorded on a DVD disc. If the region code described on the DVD disc does not correspond to the region code of this player, this player cannot play this disc. The region code of this player is "4".



Menu

Normally there is a selecting menu in a DVD disc. You can use the MENU button to enter the selecting menu directly, and use the direction buttons to highlight the item you would like and press the ENTER button to select it.

Title & Chapter

Normally there are several titles in a DVD disc, and also there are several chapters in a title. Press the TITLE button to access the title menu and select any one of titles or chapters quickly by using the Number buttons to enter the number of the chapter.

Disc Play Operations

Audio

There are up to 8 kinds of audio languages in a DVD disc. When you play a multi-language DVD disc, press the AUDIO button on remote control to select a different audio language.

Subtitle

The DVD player can support up to 32 kinds of subtitles. When you play a multi-subtitle disc, press the SUBTITLE button on remote control to select different subtitle.

Angle

The DVD player supports multi-angle function. Multi-angle means that a scene is shot from more than one angle so that audience can watch from different angles. If there are multiple angles in a scene, you can use the ANGLE button to select the desired angle.

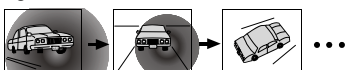

CD Playback

The player will play all tracks for CD discs continuously in default status. You can press the ⏮ and ⏭ (PREV/NEXT SKIP) buttons or number buttons to select a certain track.

MP3 Playback

Open the cover and load a MP3 disc in and close the cover. The screen displays the MP3 player:

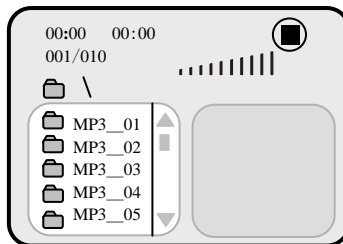

Use the ▲/▼ direction buttons to select the desired folder. Press the ENTER button to enter it.

For example, use the ▲/▼ direction buttons to choose the Folder 1, press the ENTER to enter it. Now the tracks inside are displayed.

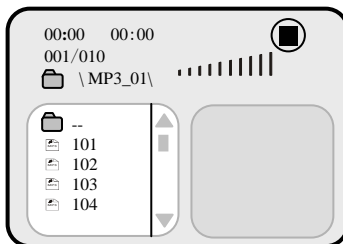

Use the ▲/▼ direction buttons to choose the desired track, press the PLAY or the ENTER button to begin the playback.

Press the STOP button to stop the playback. And then press the PLAY button, the playback will start from the beginning of the current track.

Disc Play Operations

Press the ◀ direction button to return to the root menu.

JPEG Playback

JPEG is a common picture format that requires very little storage per image with a low loss rate in resolution. Hundreds of pictures can be stored on a disc in this format. In order to create digital albums from film pictures, have your film developer make a "PICTURE CD", in JPEG format.

Normal Playback

Load a JPEG disc in. After reading the disc, the OSD will display the menu. Press the ENTER button to enter the menu. Use ▲/▼ direction buttons to choose the folder, use the ► button to enter the picture folder. Use the ▲/▼ direction buttons to choose the desired item and then press the ENTER button to begin the playback.

(Many discs have other items besides pictures.)

Picture Rotation

Pictures can be flipped and rotated while they are displayed. Once another picture is selected, rotating function will be turned off.

There are four rotational modes available. Use the direction buttons to choose:

- ▲UP Flip Vertical
- ▼DOWN Flip Horizontal
- ◀LEFT Rotate Counter Clockwise
- ▶RIGHT Rotate Clockwise

Zoom of Picture

ZOOM button is used to turn on/off zoom and move function.

When the zoom function is turned on, use the fast forward or reverse scan button to zoom in and out. Use the direction buttons to pan around on the image. Press the STOP button to activate preview mode. Press the MENU button to return to the root menu.

Note: Due to the various ways JPEG discs are made, some images can only be played normally with no rotate or zooming functions.

Playback Functions

Stop

During CD, DVD playback, press the STOP button on the remote control to stop playing. Press the PLAY button and then the player will resume play from the point where it stopped. Pressing the STOP button twice will stop the unit completely. Pressing the PLAY button again will play the disc from the beginning.

During MP3 playback, press the STOP button to stop the playback. And then press the PLAY button, the playback will start from the beginning of the current track.

Pause

Press the PAUSE button on the remote to pause. Press the PLAY button to resume normal playback.

Repeat

During CD playback, repeatedly pressing the REPEAT button will display a menu as follows: **Track** and **All**.

During MP3 playback, repeatedly pressing the REPEAT button will display a menu as follows: **Single**, **Repeat One**, **Repeat Folder**, **Folder**, **Shuffle** and **Random**.

During DVD playback, repeatedly pressing the REPEAT button will display a menu as follows: **Chapter**, **Title** and **All**.

Some discs do not support this function.

A-B Repeat

Use the A-B button to repeat a section A to B. During playback, press it once to set the starting point A, then a second to set the ending point B, and the third time to cancel repeat.

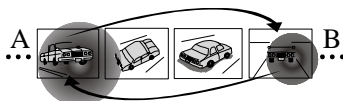

Fast Forward & Rewind

Press the ►► button to jump forward in discrete steps of 2x, 4x, 8x, 16x or 32x normal playing speed.

Likewise, press the ◀◀ button will allow you to jump backward in discrete steps of 2x, 4x, 8x, 16x or 32x normal playing speed.

During any fast forward or backward playback status, press the PLAY button to resume normal playback.

Slow Playback

During VCD disc playback, continuously press the SLOW button to start slow forward playback in discrete steps of 1/2, 1/4, 1/8, 1/16 or normal playing speed.

During DVD playback, continuously press the SLOW button to slow forward or rewind in discrete steps of 1/2, 1/4, 1/8, 1/16 or normal playing speed.

Playback Functions

Normal playback is resumed when you press the PLAY button.

There is no slow playback function for CD and MP3 discs.

Play

Press the PLAY button to start playback. Press the POWER button on the remote control to enter the standby status, and press it again to enter playing status. If there is no operation for a long time, the player will automatically enter screen saver status and then enter standby status.

Disc Information Display

Press the INFO button on remote control to display the relevant disc information.

Zoom

To enlarge or reduce the picture, press the ZOOM button on the remote control. Continually pressing the zoom button will change the mode accordingly: Enlarge x2, enlarge x3 and enlarge x4 or reduction x1/2, reduction x1/3 and reduction 1/4 repeat press the ZOOM button on the remote control to resume normal playback.

When the picture is enlarged, use the direction buttons to pan up, down, left and right.

There is no zoom function for CD and MP3 discs.

Search By Time

Use the GOTO button to search by time, namely to play from a specific time.

During DVD playback, press the GOTO button once and TV screen will display the title or chapter, then you can use number buttons to select any one of them.

Press the GOTO button twice and use the number buttons to input the desired time in sequence of hour, minute, second. Press the ENTER button to confirm and start playback from the input time.

During CD disc playback, press the GOTO button twice, then you can use number buttons to input the time you desired (hour, minute, second), and the player will play from the input time.

System Setup

Setup Menu

In stop status, press the SETUP button on the remote control and the TV screen will display a main menu. Press the SETUP button to exit the setup menu.

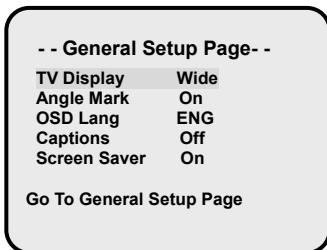

Use ◀ / ▶ direction buttons to choose the item, press the ENTER button or the ▼ button to enter it.

General Setup

Use the ◀ / ▶ buttons to select a category. Press the ENTER button or the ▼ to access the submenu. Use ▲/▼ direction buttons to select the item you want to set: TV Display, Angle Mark, OSD Lang, Captions and Screen Saver

TV Display

In the General Setup Page, use the ▲/▼ direction button to highlight the "TV Display" to bring up the menu.

Press the ▶ button to access it.

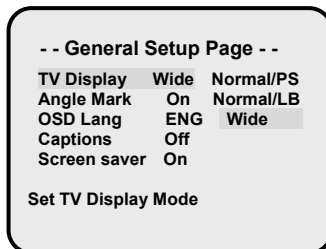

Use the ▲/▼ direction buttons to select the item you want to set. Press the ENTER button to confirm it and return to the last level.

Normal/PS Choose this mode when your TV set has 4:3 screen format. The picture will fill the screen but the right and left portion will be cut.

Normal/LB Choose this mode when your TV set has 4:3 screen format. The picture will appear in its entire width but framed by black bars at the top and the bottom.

Wide Choose this mode when using a 16:9 wide screen TV set.

Note: During DVD playback, please choose the correspond aspect ratio to match the DVD disc.

System Setup

Angle Mark

In the General Setup Page, use the ▲/▼ direction buttons to highlight the “Angle Mark.” Press the ► button to access it.

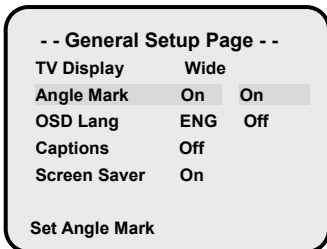

Use the ▲/▼ direction buttons to select the item you want to set. Press the ENTER button to confirm it and return to the last level.

This function is effective only if alternative viewing angles are available on the disc. Choose “On”, the camera symbol appears on the LCD screen as soon as various perspectives are available on the DVD. Choose “Off” and on camera symbol will disappear.

OSD Lang

In the General Setup Page, use the ▲/▼ direction buttons to highlight the “OSD Lang” to bring up the menu. Press the ► button to access it.

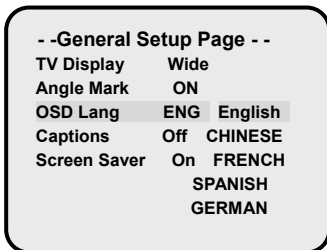

Use the ▲/▼ direction buttons to select the item you want to set. Press the ENTER button to confirm it and return to the last level.

Captions

In the General Setup Page, use the ▲/▼ direction buttons to highlight the “Captions” to bring up the menu. Press the ► button to access it.

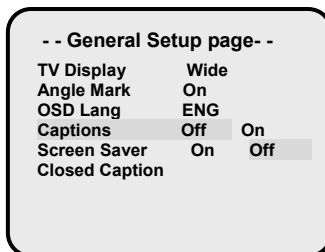

Use the ▲/▼ direction buttons to select the item you want to set. Press the ENTER button to confirm it and return to the last level.

Captions: This function is available only if your TV's type is NTSC and the disc has hidden captions. You can choose captions on or off on screen during playback.

Screen Saver

In the General Setup Page, use the ▲/▼ direction buttons to highlight the “Screen Saver” and bring up the menu. Press the ► button to access it.

System Setup

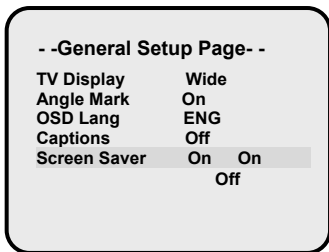

Use the ▲/▼ direction buttons to select On or Off. Press the ENTER button to confirm it and return to the last level. When On is selected, the player will display a screen saver picture after playback has stopped for some time. Select Off for no screen saver.

Speaker Setup

When General Setup has been done, press the ◀ button to return to the category menu. Use the ▶ button to choose Speaker Setup. Press ENTER or ▼ to enter it and then use the ▶ to enter the menu.

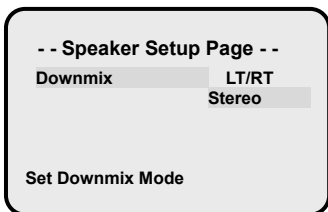

Use the ▲/▼ direction buttons to select the item you want to set. Press the ENTER button to confirm it and return to the last level.

Dolby Digital Setup

When Speaker Setup has been done, press the ◀ to return to category. Use the ▶ to choose Dolby Digital Setup, Press the ENTER or the ▼ to enter it. Use the ▲/▼ direction buttons to select the item you want to set: Dual Mono or Dynamic

Dual Mono

In Dolby Digital Setup menu, use the ▲/▼ direction buttons to highlight “Dual Mono” and bring up the menu. Press the ▶ button to access it.

□

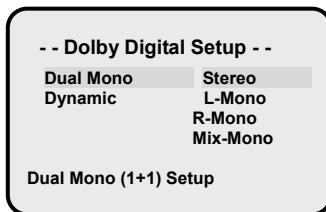

Use the ▲/▼ direction buttons to select the item you want to set. Press the ENTER button to confirm it and return to the last level.

Dynamic

In Dolby Digital Setup menu, use the ▲/▼ direction button to highlight the “Dynamic” and bring up the menu. Press the ▶ to access it.

System Setup

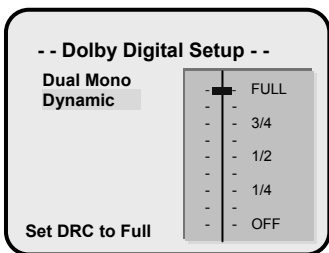

Use the ▲/▼ direction buttons to select the item you want to set. Press the ENTER button to confirm it and return to the last level.

Video Setup

When Dolby Digital Setup has been done, press the ◀ to return to the category menu. Use the ▶ to choose Video Setup and press ENTER or ▼ to enter it. Use the ▲/▼ direction buttons to select the item you want to set: Sharpness, Brightness or Contrast

Sharpness

In Video Setup menu, use the ▲/▼ direction button to highlight the “Sharpness” and bring up the menu. Press the ▶ button to access it.

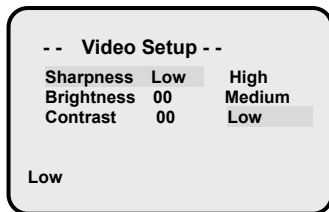

Use the ▲/▼ direction buttons to select the item you want to set. Press the ENTER button to confirm it and return to the last level.

Brightness and Contrast

In Video Setup menu, use the ▲/▼ direction button to highlight the “Brightness, Contrast” and press the ▶ to bring up the menu below:

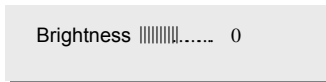

Use the ◀ / ▶ buttons to set the brightness and contrast of the picture. Press the ENTER button to confirm it and return to the last level.

Preference Page

This function is only available when the disc has been stopped. (Press the STOP button twice to stop the disc playback completely) Press the SETUP button to bring up the main menu. Use the ▶ button to choose Preference. Press the ENTER button or the ▼ button to enter it. Use the ▲/▼ direction buttons to select the item you want to set: Audio, Subtitle, Disc Menu, Password, Default Reset and Version

Audio, Subtitle, Disc Menu Language

In Preference menu, use the ▲/▼ direction button to highlight the “Audio, Subtitle, Disc Menu” and bring up the menu. Press the ▶ button to access it.

System Setup

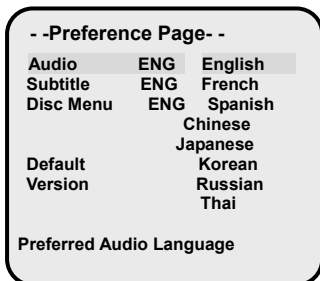

Use the ▲/▼ direction buttons to select the item you want to set. Press the ENTER button to confirm it and return to the last level.

This function is only available for discs that several audio bit streams have been recorded onto.

System Setup

Default Reset

In Preference menu, use the ▲/▼ direction button to highlight the “Default” and bring up the menu. Press the ► button to access it.

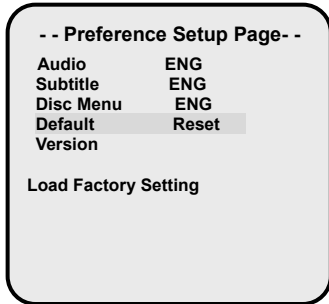

Press the ENTER if you want to recall the factory settings. All programmed settings done so far will be deleted.

Version

In Preference menu, use the ▲/▼

direction button to highlight the “Default” and bring up the right menu. Press the ► button to access it.

Version	03.01.07.03
SUB.VER	00.00.00.03
8032	03.01.07.03
Servo	40.00.DE.A2
RISC	03.01.07.03
DSP	02.04.02.56

This item is to display software version information.

Carrying Case

INSTRUCTIONS FOR ATTACHING YOUR PORTABLE DVD PLAYER CASE IN A VEHICLE

Please read and follow these instructions carefully when attaching this case inside your vehicle. For ease of installation, do not place the DVD player into the case until after the case is attached inside the vehicle.

CAUTION
1. Do not use this DVD Player Case as a swing, car seat, or for any other purpose except to hold a DVD player and accessories.
2. The DVD Player Case is intended for viewing only from the rear seats. Do not install or use this product in the front seat of a vehicle.
3. To reduce the chance of injury in case of collision or a sudden stop: <ul style="list-style-type: none">• Always keep the DVD player strapped securely inside its case while the vehicle is moving• Always keep the DVD player Case securely attached inside the vehicle while the vehicle is moving

Your DVD player can be securely attached in one of the following ways to view movies from the rear seats:

1. Directly behind either the driver or the passenger seat
2. Between two front bucket seats

CAUTION

Always position the plastic hooks and strap adjustment slider so that they do not contact the back of the head of the person in the front seat.

Attach the DVD Player Case to a seat back (Photos 1 & 2):

1. Unzip the main compartment that holds the player; locate the set of rings tucked inside the top edge of the case (A)
2. Locate the 2 straps with hooks on each end
3. Hook one end of each strap to the rings at the top of the case (A)
4. Criss-cross the straps around the front of the headrest (B) and hook the straps to a second set of rings on the lower part of the case (C)
5. Tighten up the straps until secured

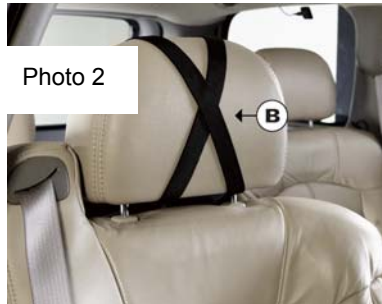

To suspend the DVD Player Case between 2 bucket seats (Photo 3):

1. Unzip the main compartment that holds the player; locate the set of rings tucked inside the top edge of the case (A)
2. Locate the 2 straps with hooks on each end
3. Hook one end of each strap to the rings at the top of the case (A)
4. Wrap each strap around the headrest or seat; hook the straps to a second set of rings on the lower part of the case (C); in some vehicles, the middle rings in the gusset might work best (D)
5. Tighten up the straps until secured

Photo 3



Troubleshooting

Symptom	What to check
No TFT LCD display	Make sure the power is on.
LCD is very bright or dark.	Use the BRIGHT +/- on the control panel to adjust the brightness.
Colors of picture are faded or bloomy.	Use the COLOR +/- on the control panel to adjust the color.
The player does not play discs or the display shows: no disc.	Make sure a disc is loaded. Make sure the disc isn't loaded upside down. Disc should be clean, not dirty or warped. Player's region code should be the same as region code of DVD disc. Has water condensation occurred? If it has, remove the disc. Keep the disc and the player powered up for about one hour.
No sound.	Make sure the volume is not set to minimum. Make sure the headphone is not connected. Make sure the player is not in pause status.
Disc skips and will not continue to play.	Make sure the player is not in A-B repeat status. Is the disc dirty or warped? If so, clean disc or press the GOTO button to skip to next chapter.
The remote control does not work.	Make sure there aren't any obstructions between the remote and the player. Make sure you are pointing the remote control at the player. Make sure batteries are inserted correctly. Replace weak batteries.

Other possibilities:

Static or other external interference may cause the player to function abnormally. In this circumstance unplug the power-supply cord from the outlet and plug it in again to reset the player so that normal operation can resume. If you are still having problems, disconnect the power and consult the nearest authorized service center.

Specifications

Laser Wavelength	Wavelength: 780/650nm
Video System	NTSC
Frequency Response	20Hz-20kHz ±2.5dB
Audio Signal-to-noise Rate	≥85dB
Audio distortion + noise	≤-70dB (1kHz)
Channel Separation	≥70dB (1kHz)
Dynamic Range	≥80dB (1kHz)
Audio Out	Out Level $2V_{\pm 0.2}$, Load 10kΩ
Video Out	Out Level $1V_{P-P} \pm 0.2$, Load 75Ω Unbalanced Negative
Power	AC100~240V, 50/60Hz
Dimension	6.69" × 6.1" × 1.53"
Weight	About 5lbs.
TFT screen size	5.6 inches (4:3)
Compliance with FCC, FDA - cUL listed E209155	

DESIGN AND SPECIFICATIONS ARE SUBJECT TO CHANGE WITHOUT NOTICE.

Manufactured under license from Dolby Laboratories.
 “Dolby” and the double-D symbol are trademarks of Dolby Laboratories.
 Confidential unpublished works. © 1992-1997 Dolby Laboratories.
 All rights reserved.

For service, support and warranty information, visit www.polaroidelectronics.com or in the US call 1-866-289-5168, in Canada call 1-866-301-7922 and in Mexico call 01-800-400-2443.

“Polaroid” is a registered trademark of Polaroid Corporation of Waltham, MA USA and licensed for use on the PDV-0560M to Petters Consumer Brands, LLC.

Free Manuals Download Website

<http://myh66.com>

<http://usermanuals.us>

<http://www.somanuals.com>

<http://www.4manuals.cc>

<http://www.manual-lib.com>

<http://www.404manual.com>

<http://www.luxmanual.com>

<http://aubethermostatmanual.com>

Golf course search by state

<http://golfingnear.com>

Email search by domain

<http://emailbydomain.com>

Auto manuals search

<http://auto.somanuals.com>

TV manuals search

<http://tv.somanuals.com>