

4GB Music & Video Player PMP120-4



User Manual

Touch MP3 Player



Headphones

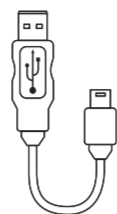

USB Cable



User Guide



CD

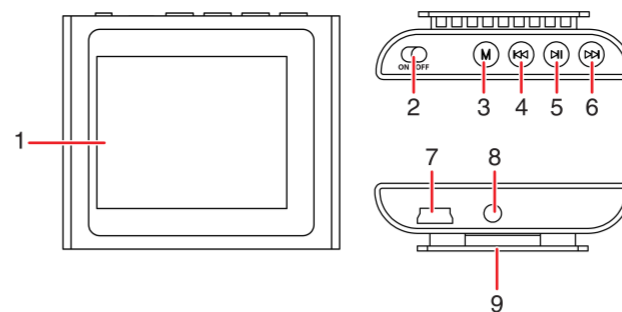

1. Touch LCD screen
2. Power on/off switch
3. [ M ] button: Select / Open menus / Previous menu / Main menu (press and HOLD)
4. [ K ] button: Previous file / Rewind (press and HOLD) / Volume down
5. [ P ] button: Play / Pause / Power on-off (press and HOLD)
6. [ F ] button: Next file / Fast Forward (press and HOLD) / Volume up
7. Mini USB port
8. Headphone jack
9. Clip

1. Slide the [POWER] switch to the ON position. Note: The player will not charge while the [POWER] switch is in the power OFF position.
2. Connect the player to your computer using the included USB cable.
3. Charge the battery between 3-5 hours. Do not charge for more than 8 hours.
4. The battery icon in the lower right corner of the charging screen is the charging indicator. It will move while charging and remain solid green when finished charging.

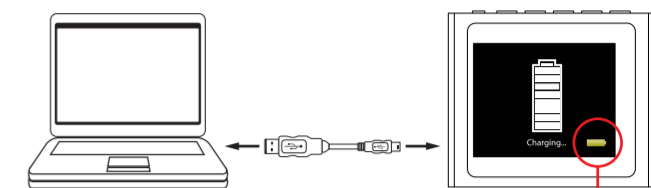

Battery level indication:

- indicates that the battery is full.
- indicates low battery; the player should be charged as soon as possible.

IMPORTANT: Charge the player for at least 8 hours before using it for the first time.

Basic operation

Turning on/off

Make sure the MP3 player is fully charged before turning it on.

- To turn on the player, make sure the [POWER] switch is in the "ON" position. If it is already in the "ON" position, then press and HOLD the [ P ] button until the display lights up.
- To turn off the player, press and HOLD the [ P ] button until the display shuts off or slide the [POWER] switch to the "OFF" position.

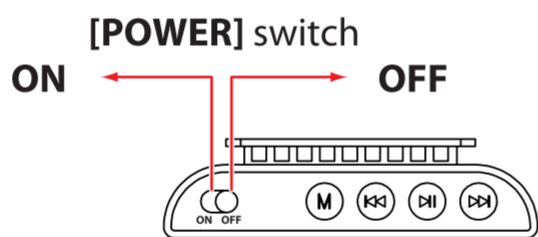

Touch screen

This player has touch screen capabilities.

1. To make a selection touch an icon or option on the screen.
2. Press the [ M ] button at any time to go back one screen.
3. Use the [ K ] and [ F ] icons on the screen to scroll through menu pages.

Volume menu

1. To adjust the volume, swipe your finger up on the screen while media is open. The volume menu appear.
2. Touch the [ K ] icon on the screen or the [ K ] button on the player to lower the volume.
3. Touch the [ F ] icon on the screen or the [ F ] button on the player to raise the volume.
4. To close the volume menu swipe your finger from right to left on the screen.

Sub menus

1. To open menu swipe your finger from left to right on the screen while media is open.
2. To make a selection touch an option on the screen
4. To close menu swipe your finger from right to left on the screen.

Main menu

To navigate the main menu touch an icon to select it OR Press the [ K ] button to move the selection left Press the [ F ] button to move the selection right Press the [ M ] button to confirm your selection

- music - play songs and voice memos
- video - play videos
- photos - view pictures
- record - record voice memos
- browser - browse all files
- settings - change player settings

*To return to the main menu at any time, while playing media or searching menus, press and HOLD the [ M ] button.*



Transferring media files to the player

1. Find music, picture, or video files on your computer.

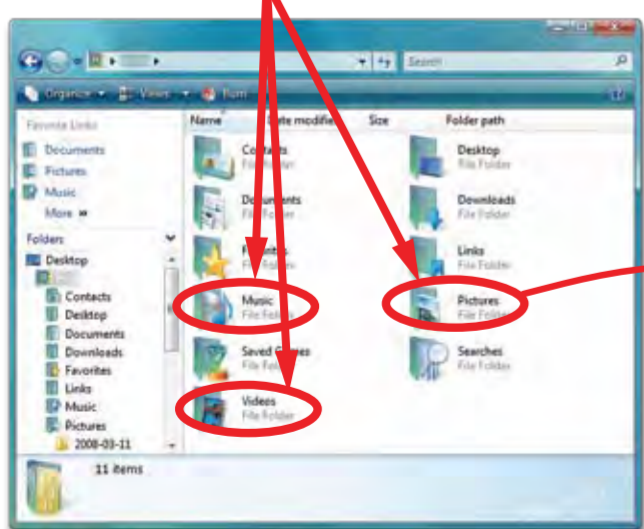

2. Connect the MP3 Player to your computer, and locate "MP3".
3. Drag or copy the files as shown below (do not drag or copy files into the "RECORD" folder).

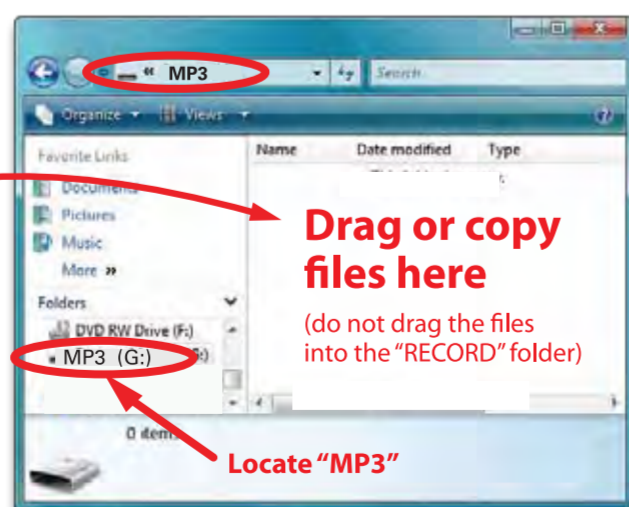

IMPORTANT: Do not disconnect the MP3 Player from the PC while transferring files as doing so will damage the MP3 Player and your files.

*It is also possible to delete files on the player while connected to the computer. Select the file and press the delete key of the computer's keyboard.*

When you are done, disconnect your MP3 Player from the computer using the "Safe Device Removal" utility in the taskbar.

NOTE: Screenshots above may be slightly different than your computer's operating system.

Music

Music touch controls

1. To play music, touch the "music" icon on the main menu. The music playing screen will be displayed.
2. To view your list of songs swipe your finger from left to right on the screen then select "Local folder".
3. Select a track to play by touching it. The music playing screen will be displayed in pause mode.
4. To play or pause the track touch the middle of the screen.
5. To skip backward or forward, touch the [ K ] or [ F ] icon on the screen.
6. To rewind or fast forward, press and HOLD the [ K ] or [ F ] icon on the screen.

*You can make a selection by using the touch screen function or you can use the player's buttons to navigate.*

Music button controls (playback screen)

1. [ M ] access music menus 1 and 2 / press and HOLD for main menu / confirm volume level
2. [ K ] previous track / rewind (press and HOLD) / decrease volume
3. [ P ] play music / pause music
4. [ F ] next track / fast forward (press and HOLD) / increase volume

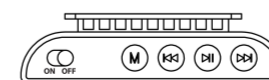

Music controls (menu 1 and menu 2)

To make a selection touch an option on the screen. OR press the following buttons: [ M ] confirms selection / press and HOLD for main menu [ K ] moves the selection up [ P ] return to music playback screen [ F ] moves the selection down

Music menu 1

1. While music is PLAYING, swipe your finger left to right or press the [ M ] button to access music menu 1 where you can select from the following options:

- Repeat mode – track repeat options
- Equalizer – select music type
- SRS WOW – adjust sound field
- Exit – exit to music playback screen

2. Touch the option to select and confirm or use the [ K ] and [ F ] buttons to select and [ M ] to confirm your choice.

Music menu 2

1. While music is PAUSED, swipe your finger left to right or press the [ M ] button to access music menu 2 where you can select from the following options:

- Local folder – browse music files on the player
- Delete file? – delete a single music file
- Delete all files? – delete all music files
- Exit – exit to music playback mode

2. Touch the option to select and confirm or use the [ K ] and [ F ] buttons to select and [ M ] to confirm your choice.

## Video converter

**i** Before transferring video files to the player, you must convert them to the correct format. Use the Video Converter on the provided CD to convert most video files to the correct format suitable for the player.

1. Insert the CD into the CD drive of your computer.

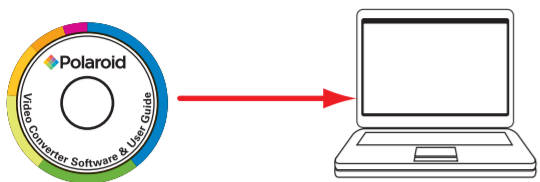

2. Click on "User Guide".
3. Click on "View" to view instructions on installing and using the video converter.



Click "User Guide"

Click "View"

## Videos

### Video touch controls

1. To play videos, touch the "video" icon on the main menu. The video playing screen will be displayed in pause mode.
2. To view your list of videos swipe your finger from left to right on the screen then select "Local folder".
3. Select a video to play by touching it. The video playing screen will be displayed in pause mode.
4. To play or pause the video touch the middle of the screen.
5. To skip backward or forward, touch the [⏮] or [⏭] icon on the screen.
6. To rewind or fast forward, press and HOLD the [⏮] or [⏭] icon on the screen.

**i** You can make a selection by using the touch screen function or you can use the players buttons to navigate.



### Video button controls

1. [M] access video menu / press and HOLD for main menu / confirm volume level
2. [⏮] previous video/ rewind (press and HOLD) / decrease volume level
3. [⏸] play music / pause music
4. [⏭] next video / fast forward (press and HOLD) / increase volume level

### Video menu

1. While a video is PAUSED, swipe your finger from left to right on the screen OR press the [M] button to access the video menu where you can select from the following options:
  - Local folder** – browse video files on the player
  - Delete file?** – delete a single video file
  - Delete all files?** – delete all video files on the player
  - Repeat mode** – video file repeat options
  - Exit** – exit to video playback screen
2. Touch the option to select and confirm or use [⏮] and [⏭] to select and [M] to confirm your choice.

### Volume menu

1. To adjust the volume, swipe your finger up on the screen while media is open. The volume menu appear. 
2. Touch the [⏮] icon on the screen or the [⏮] button on the player to lower the volume.
3. Touch the [⏭] icon on the screen or the [⏭] button on the player to raise the volume. 
4. To close the volume menu swipe your finger from right to left on the screen. 

**i** To browse video files on the player, refer to "video menu" – then search in **Local folder**.

## Photos

### Photo touch controls

1. To view photos, touch the "photo" icon on the main menu. The photo list screen will be displayed.
2. Touch a photo file to open and view it.
3. Slide your finger from bottom to top of screen to scroll through your pictures on at a time.
4. Press the [⏸] button to access your list at any time.

**i** To browse photo files on the player, refer to "photo menu" – then search in **Local folder**.

### Photo button controls (menu)

- [M] confirm selection / press and HOLD for main menu
- [⏮] moves the selection up
- [⏸] return to photo screen / play slideshow
- [⏭] moves the selection down

## Record

### Record touch controls

1. To record voice memos, touch the "record" icon on the main menu. The voice memo record screen will be displayed.
2. To start recording tap the center of the screen.
3. To pause the recording tap the center of the screen. Tap again to restart recording within the same file.
4. To stop and save your recording swipe your finger from right to left on the screen.
5. While not recording, press the [M] button to access the recording menu where you can change the recording quality (bitrate).

**Note:** You can save the recorded file while the player is recording or while it is paused by pressing and **HOLDING** the [M] button.

### Record button controls

1. Press the [⏸] button to start recording a voice memo.
2. To pause the recording, press the [⏸] button again.
3. To stop and save the recording and exit to the main menu press and HOLD the [M] button.

## Browser

### Browser touch controls

1. To browse files on the player, touch the "browser" icon on the main menu then select "Local folder".
2. Touch [⏮] and [⏭] icons to scroll through pages.
3. Touch a file to select and open it.
4. Follow instructions for viewing each file type.

### Deleting files using your computer

1. Connect the player to your computer, and locate "MP3".
2. Open "MP3" by double clicking on it.
3. Locate the file you would like to delete and **RIGHT** click on the file.
4. Locate "Delete" and **LEFT** click on the selection.
5. Select **Yes** or **No** to confirm or deny deletion of the file.

### Or

1. Connect the player to your computer, and locate "MP3".
2. Open "MP3" by double clicking on it.
3. Locate the file you would like to delete and **RIGHT** click on the file. Press **DELETE** on the keyboard.

### Photo Menu

1. While viewing the photo list screen, press the [M] button to access the photos menu where you can select from the following options:

- Local folder** – browse photo list on the player
- Slideshow mode** – set to manual or auto
- Delete file?** – delete a single photo
- Delete all files?** – delete all photos
- Exit** – exit to photo list screen

2. Touch the option to select and confirm or use the [⏮] or [⏭] button to select and the [M] button to confirm your choice.

### Slideshow

1. To change between manual photo viewing and slideshow mode, press the [M] button while in the picture list screen.
2. Select "Slideshow mode".
3. Select "Auto play" to enter automatic slideshow mode.
4. Select a picture to start the slideshow playback.
4. Use the [⏮] or [⏭] button to adjust the time between photo slides.
5. Press the [⏸] button to start the slideshow.

## Settings

In the settings menu you can customize various player settings such as date and time, language, display settings and more.

1. To change the player's settings, touch the "settings" icon on main menu.
2. The settings window will open. Where you can select from the following options:

**Time and date** – set calendar data

**Screen timeout** - set touch screen shutdown time

**Language** – change player language

**Power off** – set player shutdown time

**Memory info**– show memory usage

**Format device** – set to factory default

**Exit** - exit to previous main menu

## Troubleshooting

### Can not power on

- The battery may be exhausted, please recharge the battery.
- Check that the [POWER] switch is in the **ON** position.

### Files can not be transferred to the player

- Check if the driver is installed correctly in the computer by disconnecting and then reconnecting the player to the computer
- Check the connection between the player and PC, and confirm the USB cable is properly connected.

### Player not recognized by computer

- Check the connection between the player and PC, and confirm the USB cable is properly connected.
- Check that the [POWER] switch is in the **ON** position.

### No sound from the headphones

- Please ensure the volume is turned up, and the headphones are properly connected.
- Check if the format of music file is supported by the player.

### Can not record

- Check if there is enough memory and battery capacity.

### Display is in the wrong language

- Please ensure you selected the correct language from the "Settings" menu.

### The buttons do not work

- Slide the [POWER] switch to the left to unlock the player.

### I cannot display my .jpg files

- Many digital cameras and image editing softwares add hidden data to the .jpg files. This data can prevent the player from loading the images. Try to eliminate them by saving the file with another name.

## Legal information

### FCC Part 15:

This equipment has been tested and found to comply with the requirements for a Class B digital device under Part 15 of the Federal Communications Commission (FCC) rules. These requirements are intended to provide reasonable protection against harmful interference in a residential installation. This equipment generates, uses and can radiate radio frequency energy and, if not installed and used in accordance with the instructions, may cause harmful interference to radio communications. However, there is no guarantee that interference will not occur in a particular installation. If this equipment does cause harmful interference to radio or television reception, which can be determined by turning the equipment off and on, the user is encouraged to try to correct the interference by one or more of the following measures:

- Re-orient or relocate the receiving antenna.
- Increase the separation between the equipment and receiver.
- Connect the equipment into an outlet on a circuit different from that to which the receiver is connected.
- Consult the dealer or an experienced radio/TV technician for help.

Do not attempt to repair or modify this equipment. Warning: Changes or modifications to this equipment not expressly approved by the party responsible for compliance could void the user's authority to operate the equipment. "This device complies with Part 15 of the FCC Rules. Operation is subject to the following two conditions:

- (1) this device may not cause harmful interference, and
- (2) this device must accept any interference received, including interference that may cause undesired operation."

Shielded USB cables must be used with this unit to ensure compliance with the Class B FCC limits. Download from [www.Somanuals.com](http://www.Somanuals.com). All Manuals Search And Download.

## Warranty

PLR IP Holdings, LLC, its licensees and affiliates, fully support all electronic waste initiatives. As responsible stewards of the environment, and to avoid violating established laws, you should properly dispose of this product in compliance with all applicable regulations, directives or other governances in the area where you reside. Please check with local authorities or the retailer where you purchased this product to determine a location where you can appropriately dispose of the product.

You may also go to **HYPERLINK** "<http://www.polaroid.com>" **www.polaroid.com** and reference About / Electronic Recycling to learn more about the specific laws in your area and to locate a collection facility near your home.

If your electronic device has internal memory on which personal or other confidential data may be stored, you may want to perform a data sanitization process before you dispose of your device to assure another party cannot access your personal data. Data sanitization varies by the type of product and its software, and you may want to research the best sanitization process for your device before disposal. You may also check with your local recycling facility to determine their data sanitization procedures during the recycling process.

This Product as supplied and distributed new by AIT, Inc. ("AIT") to the original consumer purchaser is warranted by AIT against defects in material and workmanship for a period of one year from your date of purchase ("Warranty"). In the unlikely event that this product is defective, or does not perform properly, you may within one year from your original date of purchase return it to the authorized service center for repair or exchange.

### TO OBTAIN WARRANTY SERVICE:

- Provide proof of the date of purchase within the package (Dated bill of sale)
- Prepay all shipping costs to the authorized service center, and remember to insure your return.
- Include a return shipping address (no P.O. Boxes), a telephone contact number, and the defective unit within the package.
- Describe the defect or reason you are returning the product. Your product will be repaired or replaced, at our option, for the same or similar model of equal value if examination by the service center determines this product is defective. Products received damaged as a result of shipping, will require you to file a claim with the carrier.

The shipping address of the authorized service center is:

**AIT, Inc.**  
ATTN: Customer Service (2nd Floor)  
14-C 53rd Street  
Brooklyn, NY 11232

IN NO EVENT WILL AIT, ITS MANUFACTURERS, DISTRIBUTORS OR PLR IP HOLDINGS, LLC BE LIABLE FOR ANY INCIDENTAL, DIRECT, INDIRECT, SPECIAL, PUNITIVE OR CONSEQUENTIAL DAMAGES (SUCH AS, BUT NOT LIMITED TO, DAMAGES FOR LOSS OF PROFITS, BUSINESS, SAVINGS, DATA OR RECORDS) RELATED TO THIS PRODUCT. EXCEPT AS STATED HEREIN, NO OTHER WARRANTIES SHALL APPLY.

Should you have any questions or problems concerning this product, please contact our customer service department at:

Customer Support:  
☎ 1-877-768-8483 (Toll Free)  
✉ [polaroidsupport@southern telecom.com](mailto:polaroidsupport@southern telecom.com)

Monday - Thursday: 9AM - 5PM (EST)  
Friday: 9AM - 3PM (EST)

## Free Manuals Download Website

<http://myh66.com>

<http://usermanuals.us>

<http://www.somanuals.com>

<http://www.4manuals.cc>

<http://www.manual-lib.com>

<http://www.404manual.com>

<http://www.luxmanual.com>

<http://aubethermostatmanual.com>

Golf course search by state

<http://golfingnear.com>

Email search by domain

<http://emailbydomain.com>

Auto manuals search

<http://auto.somanuals.com>

TV manuals search

<http://tv.somanuals.com>