

37" LCD Television with NTSC/ATSC Tuners FLX-374



20060724

Federal Communications Commission Statement



ENGLISH

This equipment has been tested and found to comply with the limits of a class B digital device, pursuant to Part 15 of the FCC Rules. These limits are designed to provide reasonable protection against harmful interference in a residential installation. This equipment generates, uses and can radiate radio frequency energy and, if not installed and used in accordance with the instructions, may cause harmful interference to radio communications. However, there is no guarantee that interference will not occur in a particular installation. If this equipment does cause harmful interference to radio or television reception, which can be determined by turning the equipment off and on, the user is encouraged to try to correct the interference by one or more of the following measures:

1. Reorient/Relocate the receiving antenna.
2. Increase the separation between the equipment and receiver.
3. Connect the equipment into an outlet on a circuit which is different from what the receiver is connected to.
4. Consult the dealer or an experienced radio/TV technician for help.



Changes or modifications not expressly approved by the manufacturer responsible for compliance could void the user authority to operate the equipment.

Warnings and Precautions

To prevent any injuries, the following safety precautions should be observed in the installation, use, servicing and maintenance of this equipment.

Before operating this equipment, please read this manual completely, and keep it nearby for future reference.



WARNING

This symbol is intended to alert the user to avoid the risk of electric shock. This equipment must not be disassembled by anyone except qualified service personnel.



CAUTION

This symbol is intended to alert the user to the presence of important operating and maintenance instructions in the literature accompanying the appliance.



To reduce the risk of fire or electric shock, do not expose this equipment to rain or moisture.

- TO REDUCE THE RISK OF ELECTRIC SHOCK,
- DO NOT REMOVE COVER (OR BACK).
- NO USER-SERVICEABLE PARTS INSIDE.
- REFER SERVICING TO QUALIFIED SERVICE PERSONNEL.



Use of controls, adjustments or performance of procedures other than those specified herein may result in hazardous radiation exposure.

Important Safety Instructions



This symbol indicates caution points.



This symbol indicates actions that should not be done.



This symbol indicates actions that must be performed.



Do not place the equipment on any uneven or unstable carts, stands, tables, shelves etc. The equipment may fall, causing serious injury to children or adults and serious damage to the equipment itself.



Use only a cart or stand recommended by the manufacturer. This equipment and recommended cart or stand should be handled with care. Quick stops, excessive force, and uneven surfaces may cause the equipment and cart/stand to overturn.



- Do not disable the 3-wire grounding type plug. The grounding pin on the 3-prong plug is an important feature. Removing the grounding pin will increase the risk of damaging the equipment.
- If you can not fit the plug into the electrical outlet, contact an electrician to install a grounding outlet.
- Always operate this equipment from the type of power source indicated on the rear of the serial/model plate.
- Never overload wall outlets and extensions.



- Use and handle the power cord with care. Do not place any heavy objects on the AC power cord.
- Do not pull the AC power cord. Do not handle the AC power cord with a wet hand.
- Do not touch the power cord and antenna cable during lightning.
- Remove the plug from the wall outlet, if the equipment will not be used for a long period of time.
- Do not place, use or handle this equipment near water.
- Never expose the equipment to liquid, rain, or moisture.
Seek for service if any of the above is spilled into the equipment.
- Do not expose the equipment to extreme temperature or to direct sunlight, as the equipment may heat up and suffer damage.
- Do not install the equipment near any heat sources such as radiators, heat registers, stoves, or any other apparatus that might produce heat.
- Do not attempt to service the equipment yourself.
- Opening and removing the covers may expose you to dangerous voltage or other hazards and may void your warranty. Refer service to qualified personnel.
- Do not place or drop any other objects on top.
- Do not insert anything into the ventilation holes of your equipment.
Inserting any metal or flammable objects may result to fire or electric shock.
- Protect the power cord from being walked on or pinched particularly at plugs, convenience receptacles, and the point where they exit from the apparatus.
- Do not place the equipment on uneven or unstable carts, stands, tables, shelves etc. The equipment may fall, causing serious injury to children or adults and serious damage to the equipment itself.
Always place the equipment on the floor or on a surface that is sturdy, level, stable and strong enough to support the weight of the equipment.
- Do not block any ventilating openings. Leave an open space around the equipment.
Never place the equipment :
on a bed, sofa, rug, or any other similar surfaces; too close to drapes/curtains/walls, in a bookcase, built-in cabinet, or any other similar places that may cause poor ventilation.
- Unplug this apparatus during lightning storms or when unused for long periods of time.
- Refer all servicing to qualified service personnel. Servicing is required when the apparatus has been damaged in any way, such as power-supply cord or plug is damaged, liquid has been spilled or objects have fallen into the apparatus, the apparatus has been exposed to rain or moisture, does not operate normally, or has been dropped.



- Always remove the power cord from the outlet before cleaning the equipment.
- Never use liquid or aerosol cleaners on the equipment.
Clean only with a soft dry cloth.



- Only use attachments/accessories specified by the manufacturer.

Antenna Safety Instructions

If an outdoor antenna is connected, follow the precautions below:



- An outdoor antenna should not be located in any area where it could come in contact with overhead power lines, or any other electric light or power circuits.
- When installing an outdoor antenna system, extreme caution should be taken to prevent contact with power lines. Direct contact with power lines may be fatal and should be avoided at all costs.

Section 810 of National Electrical Code (NEC) provides information with respect to proper grounding of the mast and supporting structure, grounding of the lead-in wire to an antenna discharge unit, size of grounding conductors, location of antenna discharge unit, connection to grounding electrodes, and requirements for the grounding electrode.

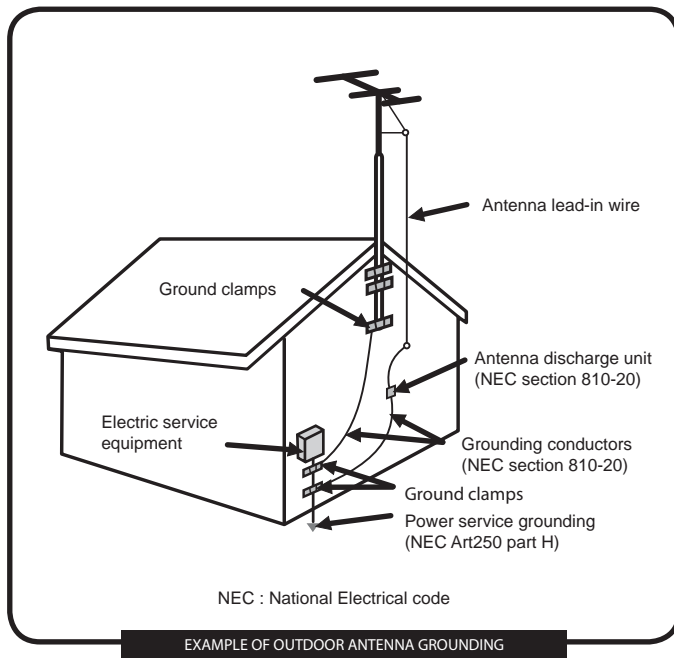

TABLE OF CONTENTS



- **Federal Communications Commission Statement** 1

- **Warnings and Precautions**
 - Important Safety Instructions 2
 - Antenna Safety Instructions 4

- **Chapter 1 Introducing the LCD TV**
 - Key Features 6
 - Package Contents 7
 - Setting Your LCD TV 8
 - Your LCD TV 10
 - Your Remote Control 12

- **Chapter 2 Installing the LCD TV**
 - Connecting a TV Cable or an Antenna 14
 - Connecting a VCR 18
 - Connecting a Video Camera or Play Station 19
 - Connecting a DVD Player 20
 - Connecting a Digital TV Cable Box or Digital Satellite Receiver 22
 - Connecting an AV Equipment with HDMI Connector 23
 - Connecting an AV Equipment with DVI Connector 24
 - Connecting a PC 25
 - Connecting an Audio Receiver or a Dolby Digital 5.1 Sound System 26

- **Chapter 3 USING THE FEATURES**
 - Using Picture-In-Picture 27
 - Wide Screen Viewing 29
 - Operating the Menu 30
 - Setting up the HDTV Function 32
 - Customizing the VIDEO Settings 35
 - Customizing the AUDIO Settings 36
 - Customizing the SETUP Settings 37
 - Using the V-CHIP Settings 39
 - Using the Parental Settings 41
 - Customizing the TV Settings 42

- **Specifications** 43

- **Chapter 4 Programming your Remote Control**
 - Introduction 45
 - Programming a Device 45
 - Troubleshooting 46
 - Manufacturer's Codes 47

Chapter 1

Introducing the LCD TV

Key Features

Various Audio/Video terminals for external equipment connection

- 2 set of composite A/V input terminals
- 1 set of S-VIDEO terminals
- 2 set of component Video input terminals
- 1 VGA/ Audio input terminal
- 1 HDMI/Auido input terminal
- 1 sets of Audio(L/R) output terminals
- 2 SPDIF output terminal (Optical x 1 /Coaxial x 1)
- 1 Headphone terminal

The built-in TV tuner to receive HD ATSC

- This function allows the reception of HD broadcasting without the addition of a set top box.

High Definition Multimedia Interface (HDMI)

- High Definition Multimedia Interface (HDMI) is a small, user-friendly interconnect that can carry up to 5 Gbps of combined video and audio in a single cable. This system eliminates the cost, complexity and confusion of multiple cables used to connect current A/V systems.

HDTV Component Video Inputs

- Offers the best video quality for DVD(480p) and digital set-top-box (HD1080i, 720p) connections.

3D Digital Noise Reduction

- This function can digitally reduce image noise to provide better picture quality.

Film-Mode Detection (3:2 Reverse Pull Down)

- This function can automatically detect content derived from film and adjust the interlacer's frame matching to provide a more natural-looking, clearer image of the moving picture.

PIP Function

- Provides viewing of two programs simultaneously, in either picture-in-picture mode or picture-on-picture (side by side) mode.

Package Contents

Make sure all of the following contents are included.

- LCD TV



- Bottom Stand /
Screw Driver and 6 Screws

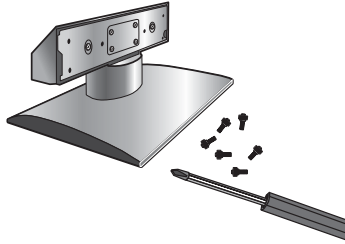

- Remote Control/
AA Batteries x 2



- VIDEO Cable



- Component Cable

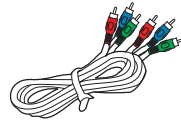

- Power Cord



- AUDIO Cable

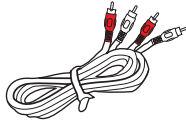

- Warranty Card



- User's Manual



- Quick Start Guide

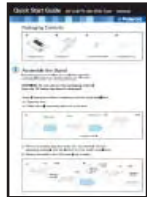

These items are all you need to set up and operate the LCD TV in its basic configuration.



Make sure all of the above contents are included in the package. If you are missing any items, please contact the Polaroid customer service department.

Setting Up Your LCD TV

Attach the Stand

If you prefer to mount your new Polaroid TV on a wall instead of attaching it to the stand, please reference the instructions included in the wall mounting kit (not included).

IMPORTANT : Attach the Stand to the TV with the bottom foam packaging material still attached.

Read all instructions before continuing with the stand installation.

- a) Lift foam packaging material from the top of the TV out of the box.
- b) Lift TV out of box, with the bottom foam packaging material still attached, and place onto a stable surface.

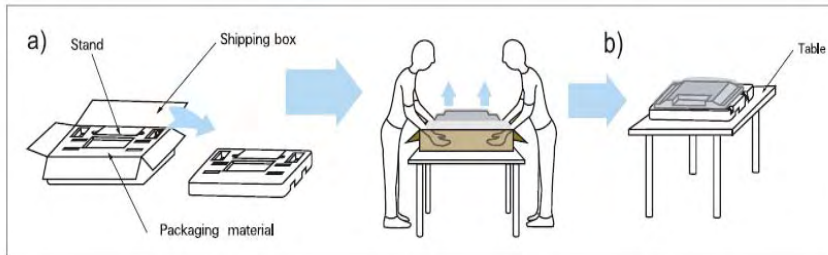

- c) Remove the protective bag from the LCD unit, but DO NOT remove the bottom foam packaging material.
- d) Locate the place on the back of the TV to attach the stand. Secure the stand to the LCD with all six screws.

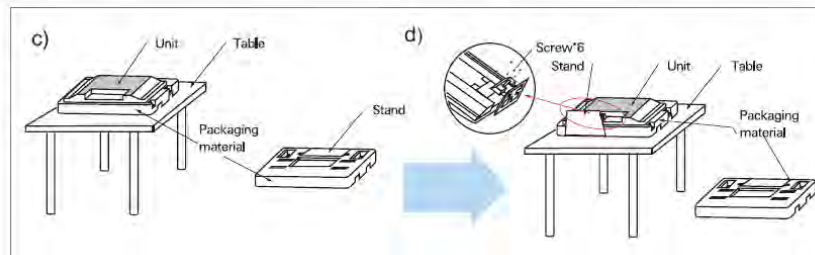

- 1 Use a supplied antenna cable to connect the VHF/UHF signal to the LCD TV's ANT. terminal (refer to page17).
- 2 Connect the AC power cord at the back of the TV and connect the power cord to wall outlet.
- 3 Insert the 2 batteries supplied in remote control.

Step1 Slide the back cover up to open the battery compartment of the remote control.

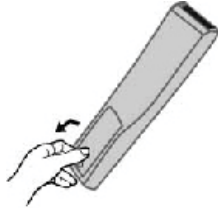

Step2 Insert two AA size batteries. Make sure to match the (+) and (-) ends of the batteries with the (+) and (-) ends indicated in the battery compartment. Slide the cover back into place.

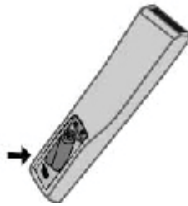

Do not use caustic cleaners (porcelain, stainless steel, toilet, or oven cleaner etc.) on the remote, as it may suffer damage.

- 4 Connect other an external A/V device (refer to page14-26).

Your LCD TV

Front/Right Side View and Controls

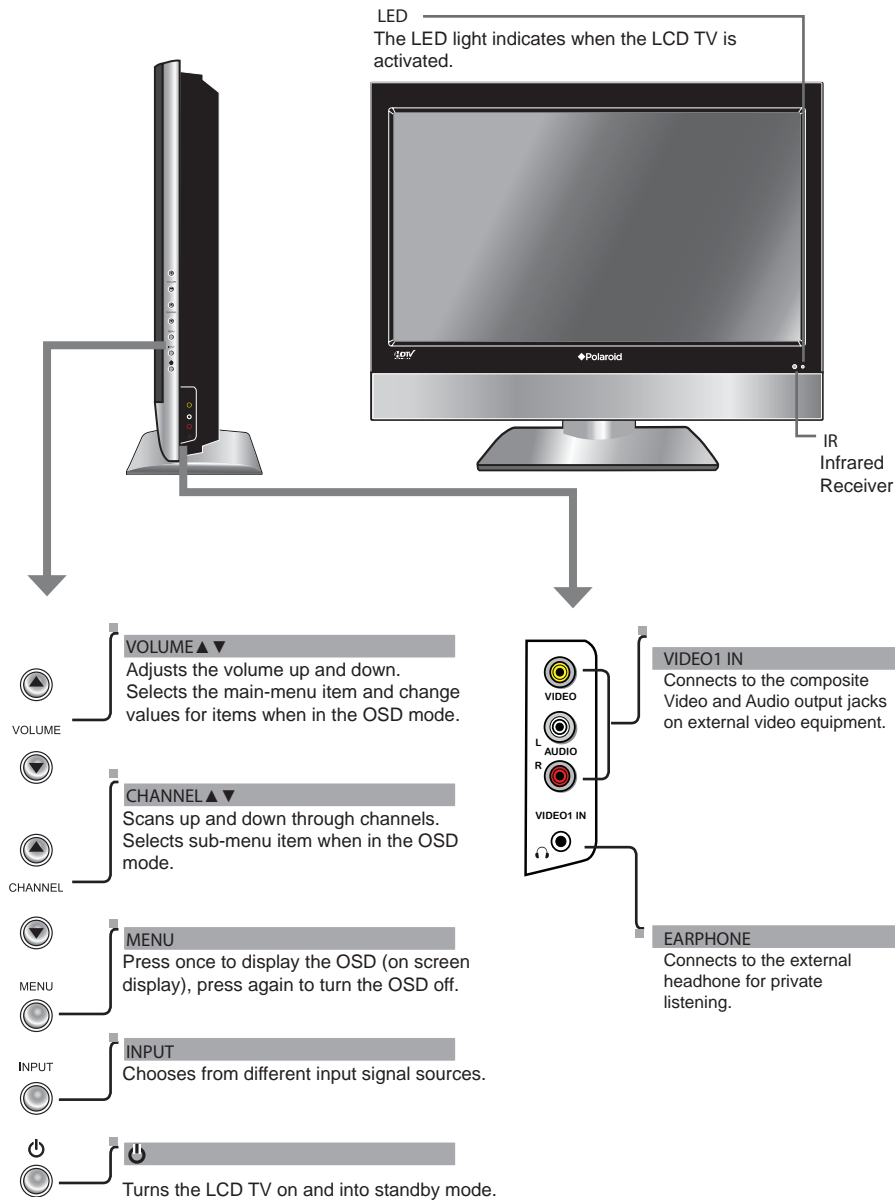

Rear View and Jacks

ENGLISH

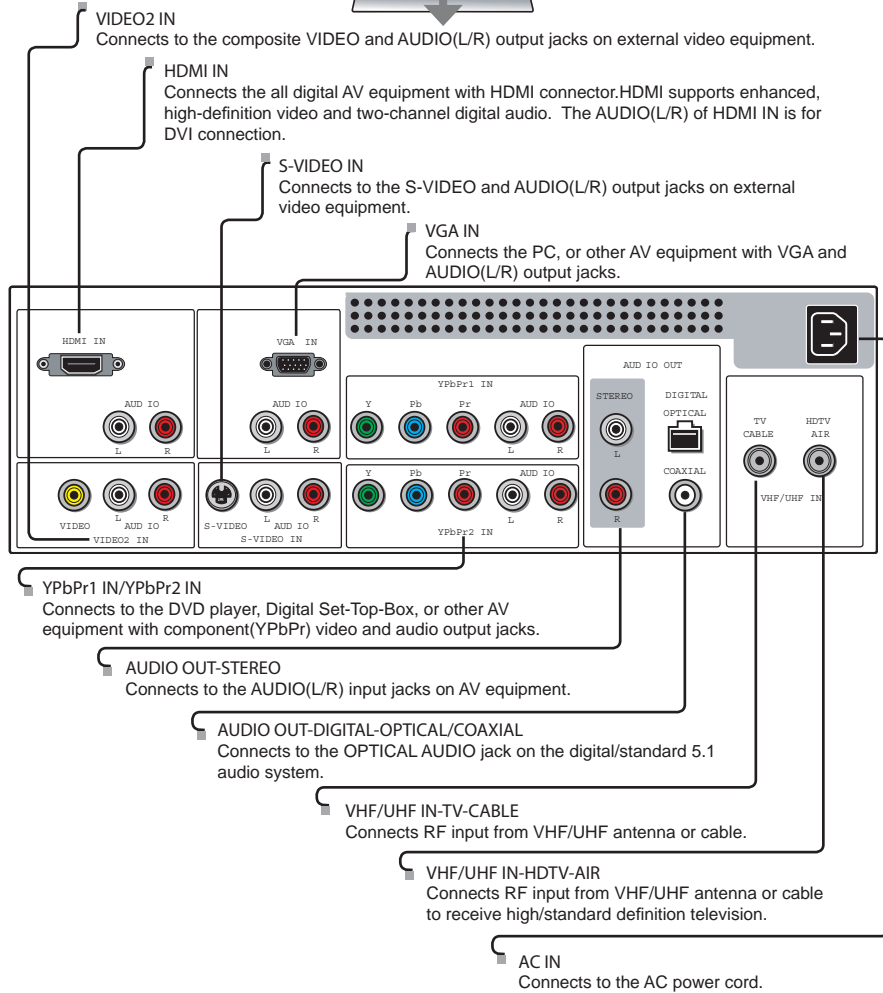
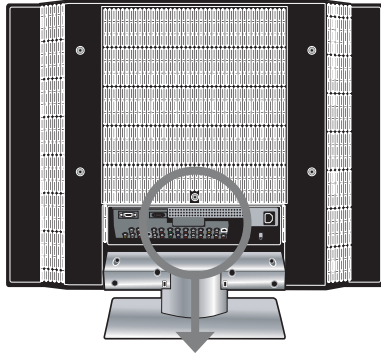

Your Remote Control

This package includes a Polaroid remote control that enables you to control up to four devices. To select a device, simply select one of the following device mode controls: TV, CBL/SAT, DVD/VCR, or AUDIO.



- 1 Turns the LCD TV on and off.
- 2 SET Remote control universal code setup. For more information on setting up your remote control, please see the "Programming Your Remote Control" section.
- 3 TV Controls this LCD TV.
- 4 CBL Controls Cable Converter or Satellite Receiver.
- DVD Controls DVD player or Video player.
- AUX Controls Audio Amplifier.
- 5 SLEEP Cycles through the LCD TV sleep time: OFF/30/60/90/120 mins.
- 6 Other device function keys
●
- 7 VOL+- Increases and decreases volume.
- 8 CH+- Change channel up and down.
- 9 MUTE Pressing once mutes audio. Pressing again restores audio.
- 10 ASPECT Cycles through Wide mode settings: NORMAL/FULL/WIDE/ZOOM.
- 11 LAST Returns to previously selected channel.
- 12 GUIDE In HDTV mode, pressing GUIDE displays the Program Guide on the screen.
- 13 PIP Turns PIP/POP on and off.
- 14 MENU Displays the OSD menu on the screen.



- 15 ▲▼▶◀,OK Cycles through OSD options and selects individual menu items. OK confirms option settings.
- 1 OK In HDTV mode, pressing OK to display a digital channel list.
- 16 CC Cycles through the Closed Caption: OFF/CC1/CC2/CC3/CC4/TT1/TT2/TT3/TT4.
- 17 INFO Pressing once displays a variety of information such as the current channel and the input source.
- 18 EXIT Exits the OSD menu.
- 19 0-9/ENTER Pressing a number selects a channel. Following selection, pressing ENTER activates the channel, or channel activates automatically in 3 seconds.
- 20 INPUT Pressing INPUT to display a source list, use ▲▼ buttons to select the video equipment connected to the video inputs of your LCD TV: TV/HDTV/VIDEO1/VIDEO2/VIDEO3/VIDEO4/VIDEO5/VIDEO6/COMPUTER.

ENGLISH



Effective range:
The remote can control the LCD TV from up to 5m away, if pointed directly at the receiver.

Chapter 2

Installing the LCD TV

Refer to the owner's manual of any external equipment to be connected.
When connecting any external equipment, do not connect any AC power cords to wall outlets until all other connections are completed.

Connecting a TV Cable or an Antenna

Antenna Connection

The antenna requirements for good color TV reception are more important than those for a black & white TV reception. For this reason, a good quality outdoor antenna is strongly recommended. The following is a brief explanation of the type of connection that is provided with the various antenna systems.

- A 75-ohm system is generally a round cable (not included) with F-type connector that can easily be attached to a terminal without tools.

F-type connector
75-ohm coaxial cable (round)
- A 300-ohm system is a flat twin-lead cable (not included) that can be attached to a 75-ohm terminal through a 300-75-ohm adapter (not included).

300-ohm twin-lead cable (flat)

Use one of the following two diagrams when connecting an outdoor antenna.

A: Shows how to use a VHF/UHF combination outdoor antenna.

B: Shows how to use a separate VHF and/or UHF outdoor antenna.

A. Combination VHF/UHF antenna

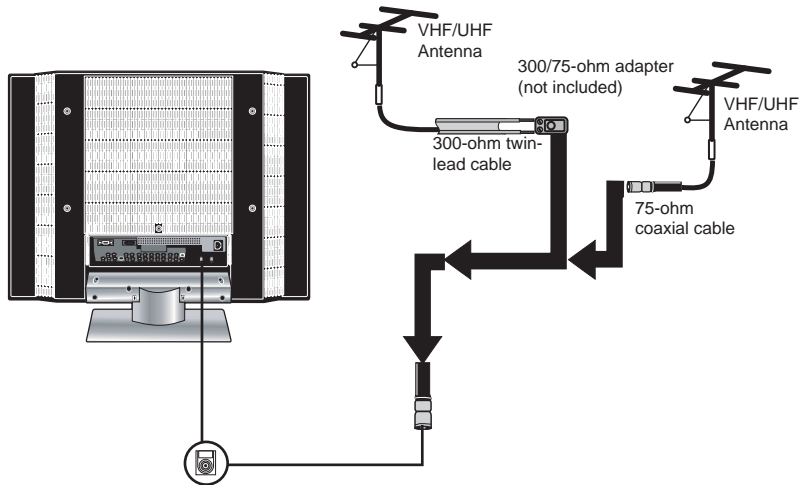

B. Separate VHF and/or UHF antennas

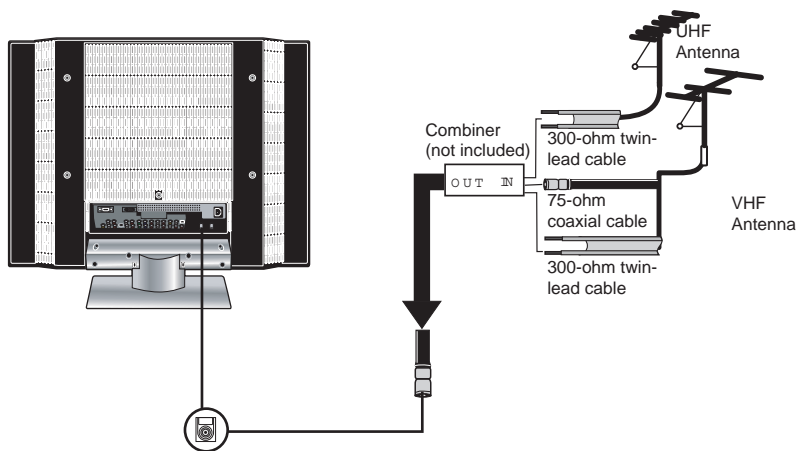

ENGLISH

Cable TV (CATV) Connection

This reminder is provided to call the CATV system installer's attention to Article 820-40 of the National Electrical Code (NEC) that provides guidelines for proper grounding and, in particular, specifies that the cable ground shall be connected to the grounding system of the building accurately, or as close to the point of cable entry as possible. Use of this TV for other than private viewing of programs broadcasted on UHF, VHF or transmitted by cable companies for the use of the general public may require authorization from the broadcast/cable company, and/or program owner.

- A 75-ohm coaxial cable connector is built into the set for easy hookup. When connecting the 75-ohm coaxial cable to the set, connect the 75-ohm cable into the ANT. terminal.
- Some cable TV companies offer premium pay channels. Since the signals of these premium pay channels are scrambled, a cable TV converter/descrambler is generally provided to the subscriber by the cable TV company.

This converter/descrambler is necessary for normal viewing of scrambled channels. (Set your TV to channel 3 or 4, typically one of these channels is used. If this is unknown, consult your cable TV company.)

For more specific instructions on installing cable TV, consult your cable TV company.

One possible method of connecting the converter/descrambler provided by your cable TV company is shown in the diagram below.

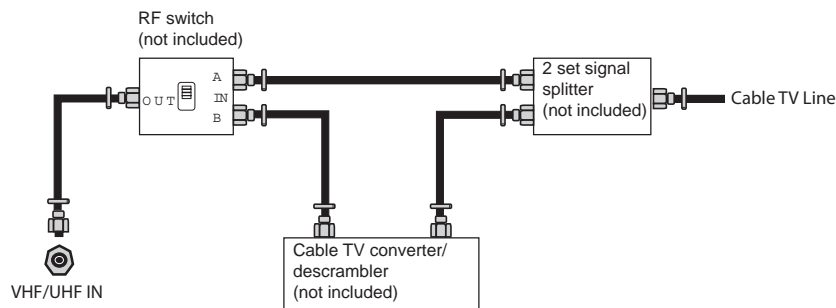

- ⚠ The RF switch (not included) is required to provide two inputs (A and B). Setting the RF switch to position A allows viewing of all unscrambled channels by using the TV channel keys.
- Setting the RF switch to position B allows viewing of all scrambled channels via the converter/descrambler by using the converter channel keys.

- 1** METHOD A:
Use a supplied antenna cable to connect the NTSC signal to the LCD TV's TV CABLE terminal.

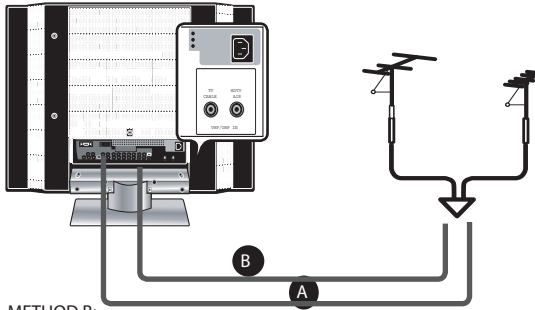

METHOD B:
Use a supplied antenna cable to connect the ATSC signal to the LCD TV's HDTV AIR terminal.

- 2** Connect the AC power cord at the back of the TV and connect the power cord to wall outlet.

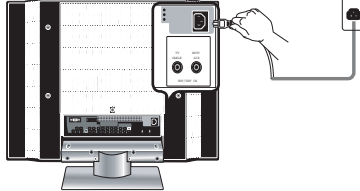

This TV is equipped with a safety fuse. In the event of an electrical storm or power outage the safety fuse is designed to protect your TV. If your TV has no power, check the fuse by prying the cover off, following the illustration below. If the fuse is blown, visit your local hardware store and ask for a 4A 250V - 5x20mm Time Lag Fuse (Slow Blow) to replace the fuse.

NOTE: Unplug the AC power cord from the back of your TV before removing the fuse.



- 3** Press the **⏻** button on the remote to turn on the LCD TV.

! Always disconnect the LCD TV from the main voltage when the LCD TV will not be used for a long period of time. The POWER button on the front panel is only used for switching the LCD TV into standby, it does not disconnect the device from the main voltage. To completely disconnect the main voltage, please remove the power plug from the socket.

- 4** Press the Input button on the remote to display the Input List. Use the **▲▶** buttons to select TV (METHOD A), or HDTV (METHOD B), and press the OK button.

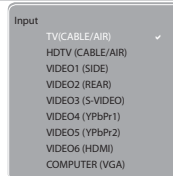

Connecting a VCR

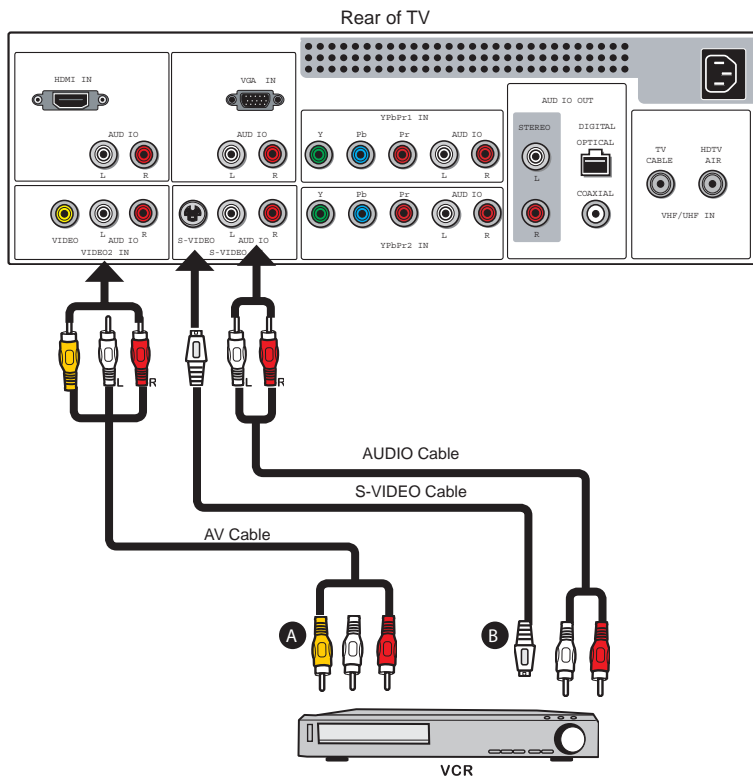

- 1** **METHOD A:**
Use a composite cable to connect the VCR's composite video/audio jacks to the LCD TV's VIDEO2 IN jacks.

METHOD B:
Use an audio cable to connect the VCR's audio output jacks to the LCD TV's audio inputs. Use a S-Video cable to connect the VCR's s-video output jack to the LCD TV's S-VIDEO IN input jack.
- 2** Connect all AC power sources, before turning on the power switch of the LCD TV or other connected equipment.
- 3** Press the  button on the remote to turn on the LCD TV.
- 4** To watch a videotape, press the Input button on the remote to select VIDEO2 (METHOD A), or VIDEO3 (METHOD B).

Connecting a Video Camera or Play Station

ENGLISH

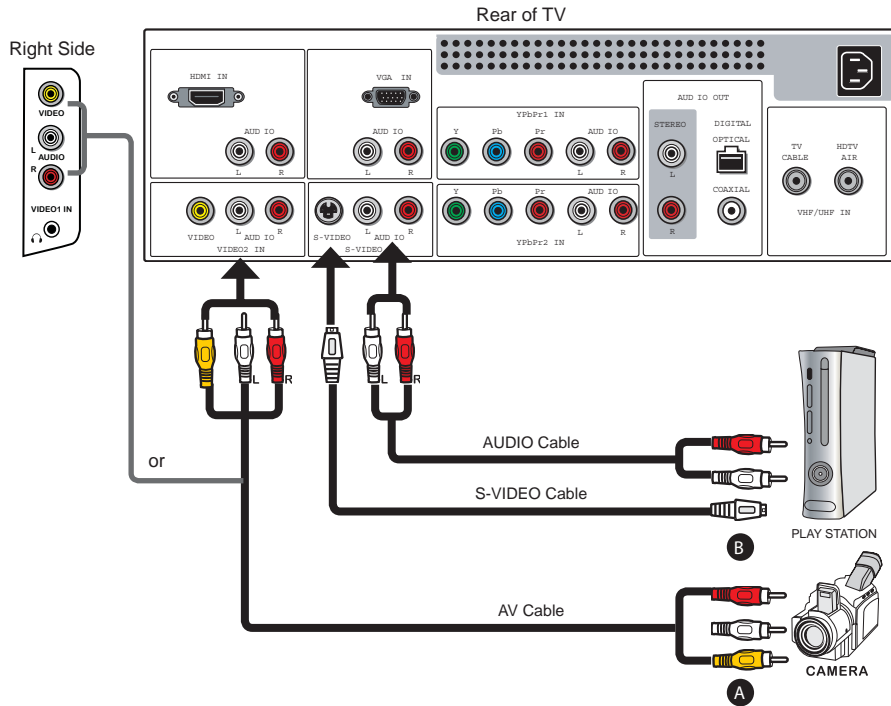

1

METHOD A:

Use a composite cable to connect the video camera's or play station's composite video/ audio jacks to the LCD TV's VIDEO2 IN jacks or VIDEO1 IN jacks.

METHOD B:

Use an audio cable to connect the video camera's or play station's audio output jacks to the LCD TV's audio inputs. Use a S-Video cable to connect the video camera's or play station's s-video output jack to the LCD TV's S-VIDEO IN input jack.

2

Connect all AC power sources, before turning on the power switch of the LCD TV or other connected equipment.

3

Press the  button on the remote to turn on the LCD TV.

4

To watch a video vis camera or play station, press the Input button on the remote to select VIDEO2/VIDEO1(METHOD A), or VIDEO3 (METHOD B).



Not all cameras have the ability to connect to a TV. Please check your video camera user guide for compatibility.

Connecting a DVD Player

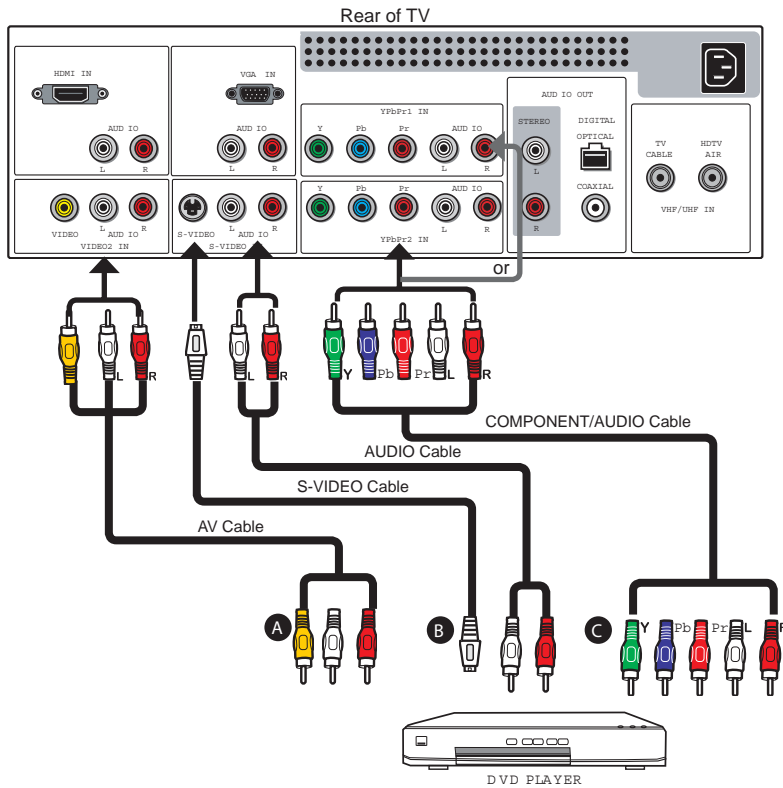

1

METHOD A:

Use a composite cable to connect the DVD player's composite video/audio jacks to the LCD TV's VIDEO2 IN jacks.

METHOD B:

Use an audio cable to connect the DVD player's audio output jacks to the LCD TV's audio inputs. Use a S-Video cable to connect the DVD player's s-video output jack to the LCD TV's S-VIDEO IN input jack.

METHOD C:

Use a component cable to connect the DVD player's component output jacks to the LCD TV's YPbPr1 IN or YPbPr2 IN input jacks.

Use an audio cable to connect the DVD player's component audio jacks to the LCD TV's audio input jacks.



The component video jacks on your DVD player are sometimes labeled YPbPr, or YCbCr. For an explanation of component video, see your DVD player's user guide.

- 2 Connect all AC power sources, before turning on the power switch of the LCD TV or other connected equipment.
- 3 Press the  button on the remote to turn on the LCD TV.
- 4 To watch a DVD, press the Input button on the remote to select VIDEO2(METHOD A), or VIDEO3 (METHOD B), or VIDEO4/VIDEO5 (METHOD C).

 For best picture quality, if your equipment has component video output, use a component cable instead of a composite video or S-video cable.

ENGLISH

Connecting a Digital TV Cable Box or Digital Satellite Receiver

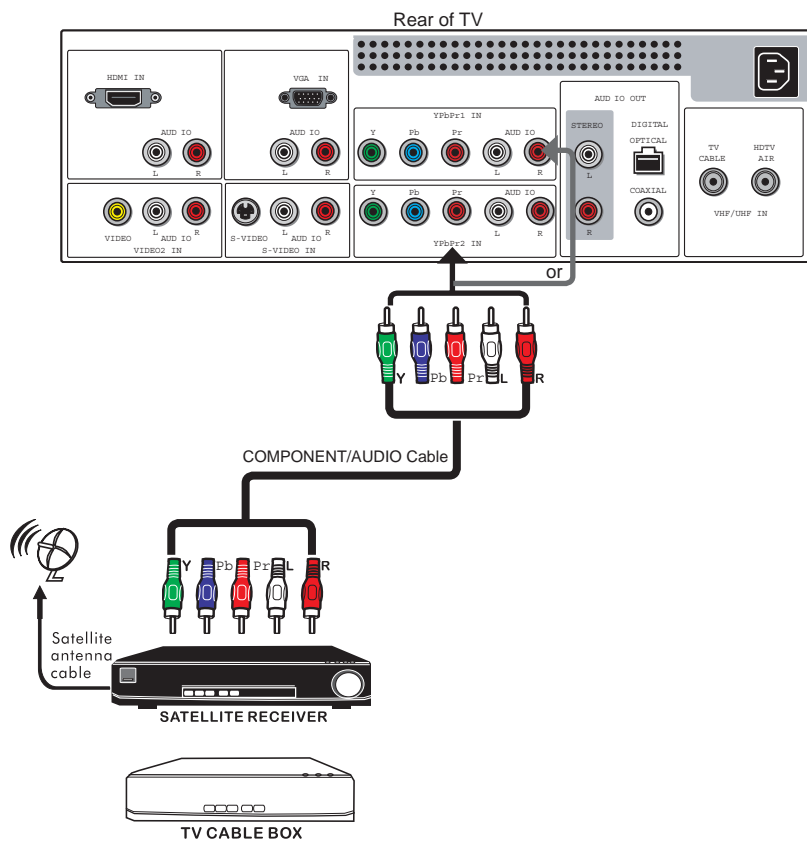

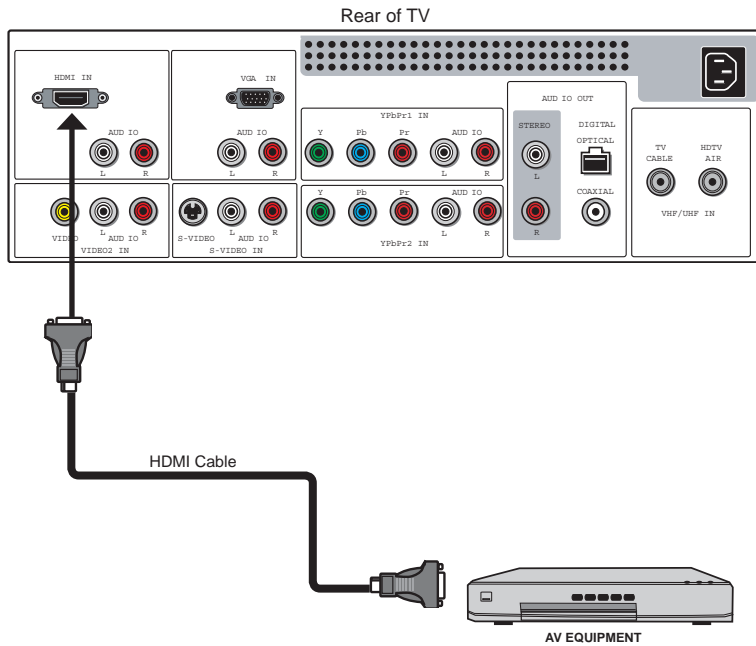

- 1 Use a component cable to connect the satellite receiver's/TV Cable Box's component (YPbPr1) output jacks to the LCD TV's component input jacks. Use an audio cable to connect the satellite receiver's/TV Cable Box's component audio jacks to the LCD TV's audio input jacks.
- 2 Connect all AC power sources, before turning on the power switch of the LCD TV or other connected equipment.
- 3 Press the  button on the remote to turn on the LCD TV.
- 4 To watch programs via satellite receiver or TV Cable Box, press the Input button on the remote to select VIDEO4/VIDEO5.

Connecting an AV Equipment with HDMI Connector





ENGLISH

- 1 Use a HDMI cable to connect the AV equipment's HDMI output jack to the LCD TV's HDMI IN jacks.
- 2 Connect all AC power sources, before turning on the power switch of the LCD TV or other connected equipment.
- 3 Press the  button on the remote to turn on the LCD TV.
- 4 Press the Input button on the remote to select VIDEO6.

 The HDMI connector provides both video and audio signals, it's not necessary to connect the audio cable.

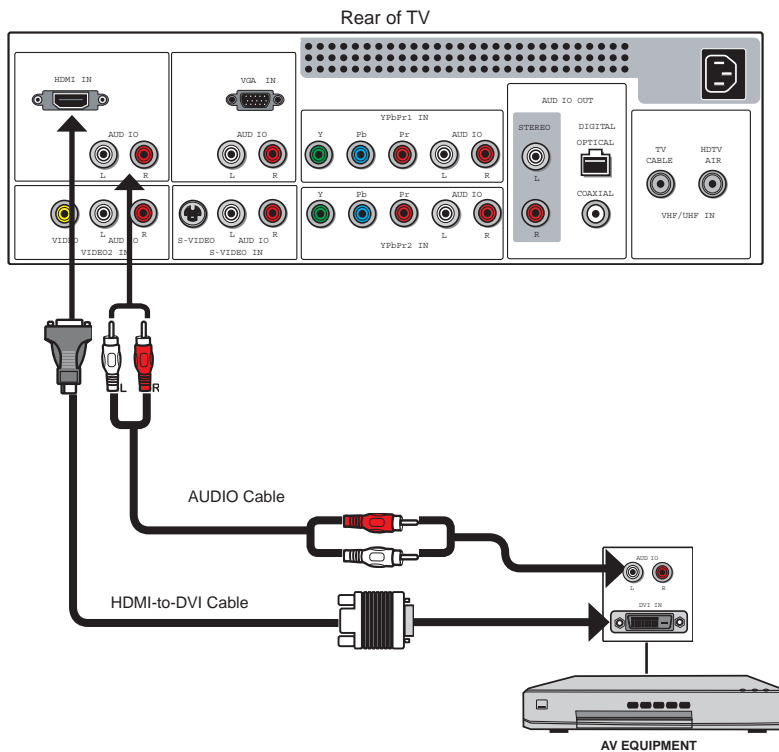
Connecting an AV Equipment with DVI Connector



- 1 Use a HDMI-to-DVI cable to connect the AV equipment's DVI output jack to the LCD TV's HDMI IN jacks.
Use an audio cable to connect the AV equipment's audio output jacks to LCD TV's HDMI AUDIO jacks.
- 2 Connect all AC power sources, before turning on the power switch of the LCD TV or other connected equipment.
- 3 Press the  button on the remote to turn on the LCD TV.
- 4 Press the Input button on the remote to select VIDEO6.



If the LCD TV is connected to AV equipment's DVI connector, you will need an HDMI-to-DVI cable or an HDMI adapter(not supplied).

Connecting a PC

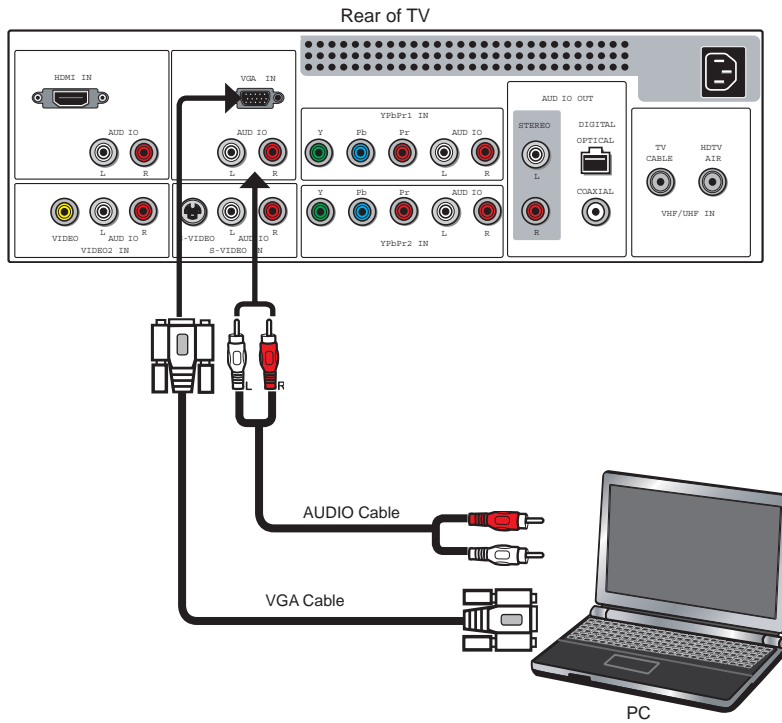

ENGLISH

- 1 Use a D-SUB cable to connect the PC's D-SUB output jack to the LCD TV's VGA input jack. Use an audio cable to connect the PC's audio output jacks to LCD TV's.
- 2 Connect all AC power sources, before turning on the power switch of the LCD TV or other connected equipment.
- 3 Press the  button on the remote to turn on the LCD TV.
- 4 Press the Input button on the remote to select COMPUTER.

Connecting an Audio Receiver or a Dolby Digital 5.1 Sound System

For better sound quality, you may want to play the LCD TV audio through your stereo system.

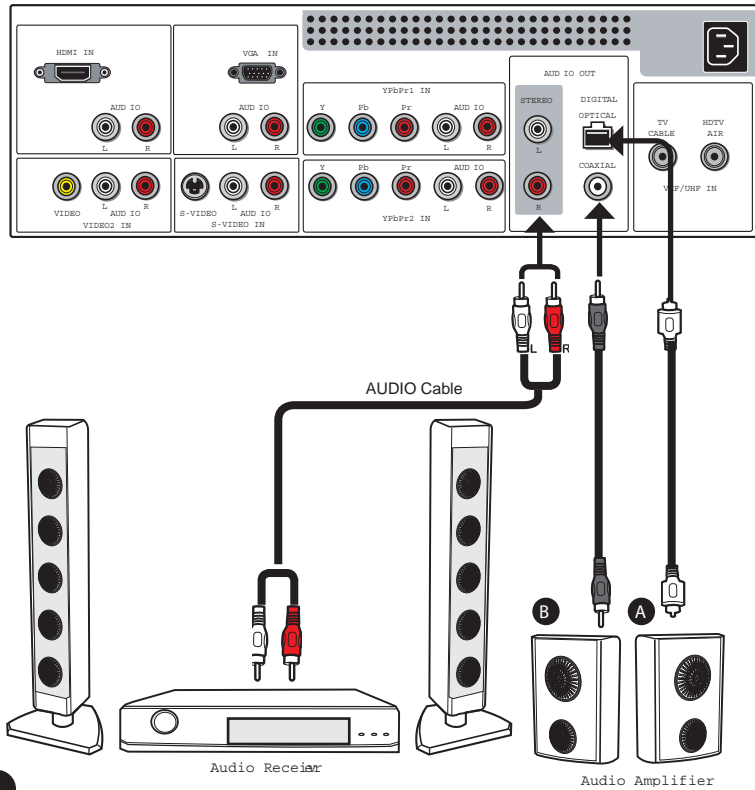

- 1** Connecting to Audio Receiver:
Use an audio cable to connect the audio receiver's audio LINE IN jacks to LCD TV's AUDIO OUT jacks.
- 2** Connecting to Digital 5.1 Sound System:
METHOD A:
Use an optical cable to connect the audio amplifier's OPTICAL IN jacks to LCD TV's OPTICAL OUT jacks.

METHOD B:
Use a coaxial cable to connect the audio amplifier's COAXIAL IN jacks to LCD TV's COAXIAL OUT jacks.

Note: Above mentioned function is only available under HDTV (cable/air) mode.
- 3** Connect all AC power sources, before turning on the power switch of the LCD TV or other connected equipment.
- 4** Press the  button on the remote to turn on the LCD TV.

Chapter 3

USING THE FEATURES

ENGLISH

Using Picture-In-Picture

The PIP/POP feature allows simultaneous viewing of video from two sources (TV, VCR, DVD etc). Only one source's audio is played at a time; the user may select which source's audio is heard.

NOTE: Picture-in-Picture/Picture-on-Picture do not work when both picture sources are coming from component input (YPbPr).

- 1 Press the PIP button once to enter picture in picture mode.



- Press ◀ ▶ to toggle the audio source between the main window and the sub window.
- Press the OK button to change the position of the second window.

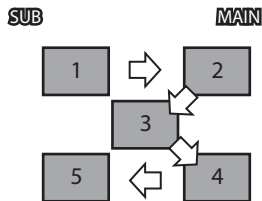

- Press ◀ ▶ to activate either the main or sub window, then press the Input button to display the Input List:

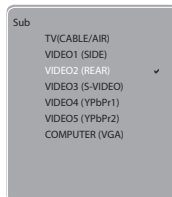

- Press ▲ ▼ to change input source and press the OK button.

- 2 Press the PIP button again to view images side by side.



- Press ◀ ▶ to toggle the audio source between the main window and the sub window.
- Press the OK button to swap the pictures between the main and sub windows.



- Press ◀ ▶ to activate either the main or sub window, then press the Input button to display the Input List:

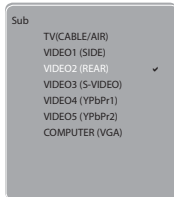

Press ▲ ▼ to change input source and press the OK button.

NOTE: PIP does not function when VIDEO4 (YPbPr1) and VIDEO5 (YPbPr2) inputs are selected together.

- 3 Press the PIP button again to exit.

Wide Screen Viewing

Wide Screen function allows viewing of 4:3/16:9 images in wide screen mode, cycling through the following wide screen settings. Press the ASPECT button repeatedly to select the screen format you want.

ENGLISH

1**NORMAL**

Displays at 4:3 aspect ratio.

**2****FULL**

Stretches the image vertically and horizontally to keep the image size consistent in the center of the screen and stretches the sides

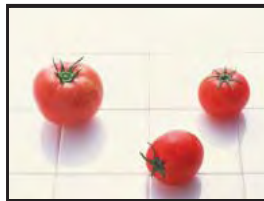
**3****WIDE**



Stretches the image vertically and horizontally to fill the screen at 1:1.85 aspect ratio.

**4****ZOOM**

Stretches the image vertically and horizontally to fill the screen at 1:2.35 aspect ratio.



Operating the Menu

- 1 Press the  button to turn the LCD TV on.
- 2 Press the MENU button on the remote control, the on-screen menu will appear on the screen. Use the   buttons to select your main menu option.

VIDEO MENU:

Allows you to make adjustments to your picture settings.

- If the signal source is VGA, the VIDEO MENU appears as:
- If the signal source is TV/HDTV/VIDOE/SVIDEO/YPbPr/HDMI, the VIDEO MENU appears as:

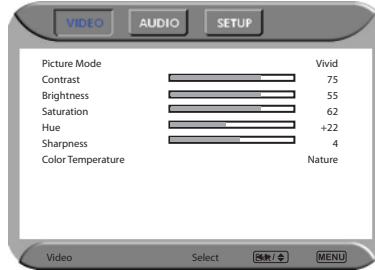
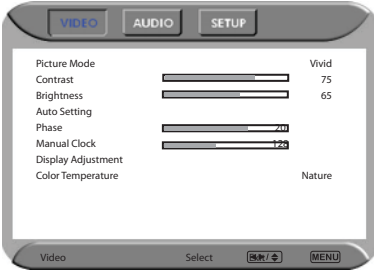

AUDIO MENU:

Allows you to customize the audio options and effects.

- If the signal source is VIDOE/SVIDEO/YPbPr/HDMI/VGA, the AUDIO MENU appears as:
- If the signal source is TV, the AUDIO MENU appears as:

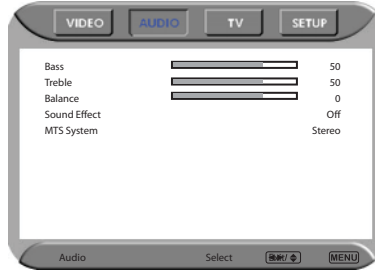
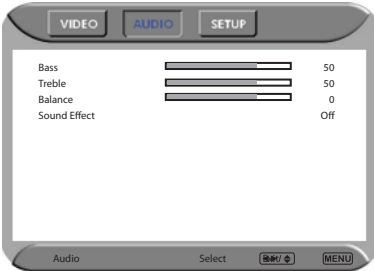

- If the signal source is HDTV, the AUDIO MENU appears as:

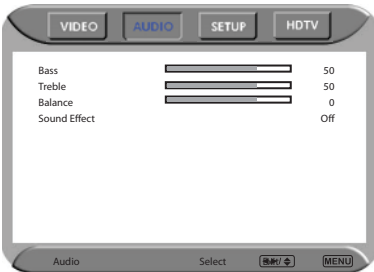

SETUP MENU:

Allows you to set up a variety of features: Language, Closed Caption, factory reset, V-Chip, Parental Control sleep timer.



ENGLISH

TV MENU:

Allows you to edit and label channels.

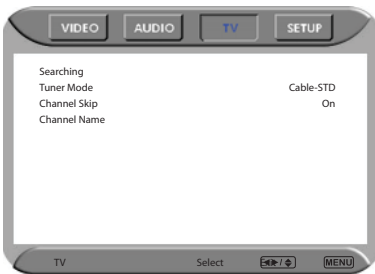
**HDTV MENU:**

Allows you to set up the HDTV program function.



- 3** Use the ▲▼ buttons to select an option of the sub-menu, and press the OK button. While in adjustment mode, and use the ◀▶ buttons to change the value of the item.
- 4** Press the MENU button to exit the menu.

Setting up the HDTV Function

Automatically scans and stores all the TV channels

- 1 With the LCD TV connected to a television programming source, press the TV button on the remote control.

- 2 Press the MENU button on the remote control to display the Main menu, and use the ◀▶ buttons to select the HDTV.



- 3 Press the ▼ button to select Auto Scan, and press the OK button. The Auto Scan automatically creates a list of receivable channels. Press the MENU button at any time to interrupt the memorization process.(the list cannot be created if interrupted)

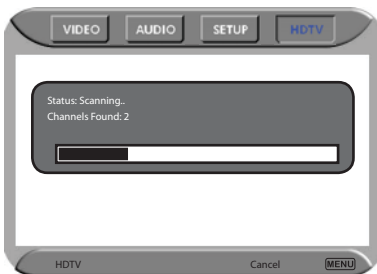

- 4 Press the OK button to display the received channel list, then press ▲▼ the buttons to select a channel. Or, use the ▸ (Input button) with 0-9 buttons to select digital channel(for example 9.1)

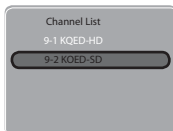

The digital main channel might include many subchannels (for example 9-1, 9-2...) that are showing program at the same time.

5

The HDTV menu includes the following options:

Audio Language	Allows to select the audio language: English/Spanish/French.
Time Zone	Allows selection of regional TV systems of USA: Eastern Time/Indiana/Central time/Mountain Time/Arizona/Pacific Time/Alaska/Hawaii
SPDIF Type	Allows to selection of the digital sound format: PCM/OFF/Dolby Digital
Auto Scan	Automatically sets up channel list on TV for all receivable channels.
Manual Scan	Allows to set up TV channel manually.
Channel Skip	Allows addition/removal of digital channels.
Channel Block	Allows to block digital channels. Use the Channel Block function, must enter a four-digit password. The factory password is 0000.

Caption

Allows to set closed caption:



- **Analog Closed Caption:**
Allows to set basic analog closed caption options: OFF/CC1/CC2/CC3/CC4
- **Digital Closed Caption:**
Allows to set digital closed caption options: Service1/Service2/Service3/Service4/Service5/Service6/OFF
- **Caption Style:**
Allows to customize the settings for digital closed caption option:

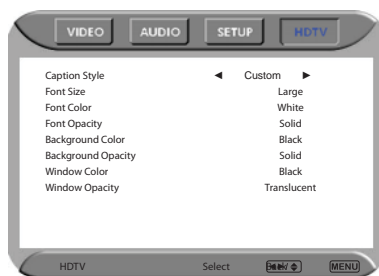

ENGLISH

Using the Program Guide

The Program Guide feature brings all sorts of information provided by the cable TV company to your screen, such as program title, program duration, time remaining, rating information, closed caption, availability, etc.

- 1 With the LCD TV connected to a television programming source, press the TV button on the remote control.
- 2 Press the GUIDE button on the remote control, the Program Guide will appear on the screen:

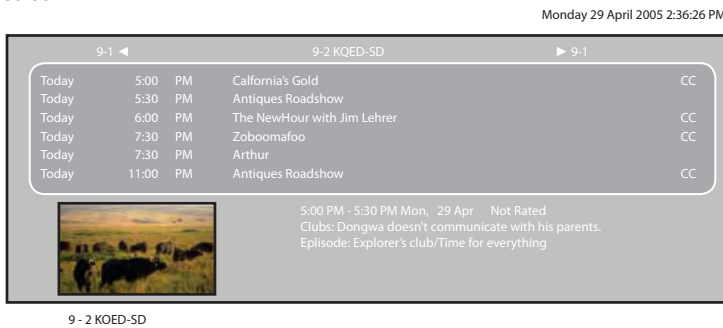

- 3 Press the ▲▼ button to select the program from a list, the Program Guide provides introduction about the current program being shown on each channel.

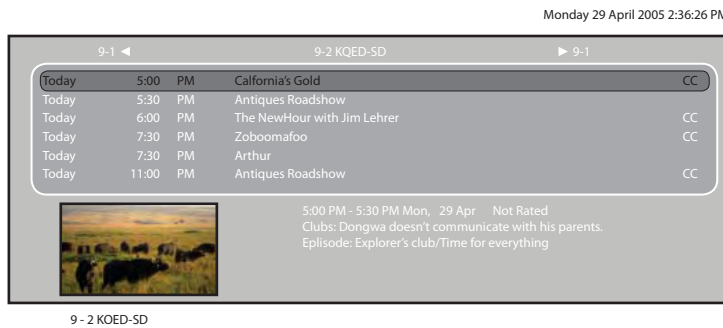

- 4 Press the GUIDE button again on the remote control to exit the Program Guide

Customizing the VIDEO Settings



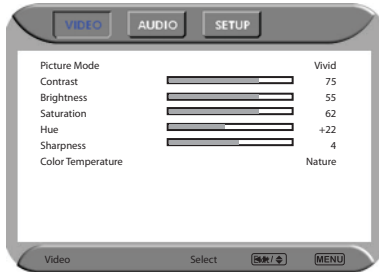



- 1 Press the **⏻** button to turn the LCD TV on.
- 2 Press the MENU button on the remote control to display the Main menu, and use the **◀▶** buttons to select the VIDEO.
- 3 Use the **▲▼** buttons to highlight an individual VIDEO option, use the **◀▶** buttons to change the setting, and press the MENU to exit the menu



- 4 The VIDEO menu includes the following options:

Picture Mode	Cycles among display types: Vivid/Hi-Bright/Cinema/Sport/User
Contrast	Controls the difference between the brightest and darkest regions of the picture.
Brightness	Controls the overall brightness of the picture.
Saturation	Controls the color intensity.
Hue	Controls the difference between the green and red regions of the picture.
Sharpness	Increase this setting to see crisp edges in the picture; decrease it for soft edges.
Color temperature	Adjusts color components independently to achieve a warm or cool effect: Cool/Middle/Warm/User <ul style="list-style-type: none"> ▪ Warm: Increases red tint ▪ Nature: Increases natural tint ▪ Cool: Increases blue tint ▪ User: Allows the user to adjust red, green and blue color component levels independently.

Customizing the AUDIO Settings



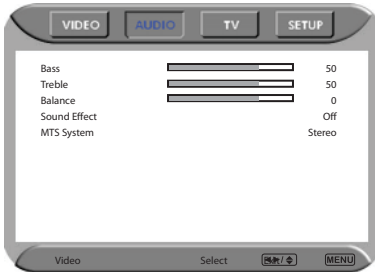



- 1 Press the  button to turn the LCD TV on.
- 2 Press the MENU button on the remote control to display the Main menu, and use the   buttons to select the AUDIO.
- 3 Use the   buttons to highlight an individual AUDIO option, use the   buttons to change the setting, and press the MENU to exit the menu



- 4 The AUDIO menu includes the following options:

Bass	Controls the relative intensity of lower-pitched sounds.
<hr/>	
Treble	Controls the relative intensity of higher pitched sounds.
<hr/>	
Balance	Adjusts the relative volume of the speakers in a multiple speaker system.
<hr/>	
Sound Effect	Allows selection of an audio-enhancement technique from among the following options: Surround/Live/Dance/Techno/Classic/Soft/Rock/POP/Off.
<hr/>	
MTS System	<p>Allows you to listen to high-fidelity stereo sound while watching TV.</p> <ul style="list-style-type: none"> ▪ Stereo: Use separate audio tracks for left and right speakers, if available. ▪ SAP: You can enjoy a second audio program from the speakers while watching a scene in the original program. ▪ Mono: Allows mono output (useful when stereo is noisy or inconsistent).
<hr/>	

Customizing the SETUP Settings

- 1 Press the  button to turn the LCD TV on.
- 2 Press the MENU button on the remote control to display the Main menu, and use the   buttons to select the SETUP.
- 3 Use the   buttons to highlight an individual SETUP option, use the   buttons to change the setting, and press the MENU to exit the menu.



- 4 The SETUP menu includes the following options:

Language Selects to display all on-screen menus in your language of choice: English/Tradition Chinese/Simplified Chinese/French/Spanish.

Timer Allows to set up clock and to program the TV to turn on and off and tune to a specific channel.

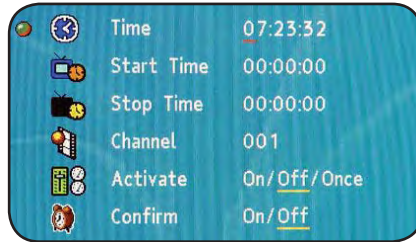

- **Time:**
Selects to set the current time by hour, minute, second.
- **Start Time:**
Selects to set the time that you want the TV to turn on.
- **Stop Time:**
Selects to set the time that you want the TV to turn off.
- **Channel:**
Selects to set the specific channel that you want the TV to tune.
- **Activate:**
Selects to turn on/off/once the timer.
- **Confirm:**
Selects to confirm.

- Closed Caption
- Allows to select from 4 closed caption modes:
 - CC1 /CC2 /CC3 /CC4:
Display a printed version of the dialog and sound effects of the program being viewed.
 - T1/T2:
Display station information presented using either half or the whole screen.
 - T3/T4:
Extended Data Services. For example: Network name, program name, program length, etc.

NOTE: For better viewing CC in text mode will have a black box behind the text.

V-Chip	Allows to setup the TV and MPAA Rating Lock options(refer to "Using the V-CHIP Setting").
Parental	Allows to setup the Parental Lock options.
Default	Restores factory settings.

Using the V-CHIP Settings

The US has 2 rating system for viewing content: Movie blocking(MPAA) and TV Blocking. The TV Blocking conjuncts with the V-CHIP to help parents block inappropriate programs from their children.

The Movie blocking(MPAA) is used for original movies rated by the Motion Picture Association of America(MPAA) as broadcasted on cable TV and not edited for television.

The V-CHIP can also be set to block MPAA-rated movies.

- 1 Use the ▼ button to select the V-Chip, and press the OK to display the V-Chip menu.

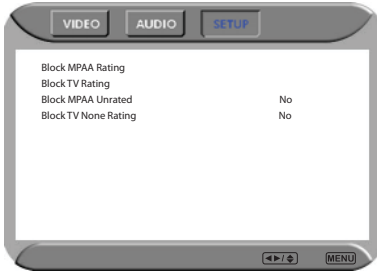

- 2 The factory preset password is 0000. This password must be used first before setting your own personal password. It is recommended that you keep your personal password in a safe place and away from children. In the event you loose your personal password the master password is 8202. The master password overrides all passwords. The master password can't be changed and should be kept in a safe place away from children.



- 3 The MPAA includes the following options:

RATING	DESCRIPTION
G	General Audiences. Movie is appropriate for all ages.
PG	Parental Guidance Suggested. May contain material not suited for younger viewers
PG-13	Contains content that may not be appropriate for viewers under the age of 13.
R	Restricted. Contains adult content, no one under 17 admitted without parent.
NC-17	No one 17 and under admitted.
X	No one 17 and under admitted.

Use the ▲▼ buttons to select the rating you want and press the OK button repeatedly to select BLOCK(✓) or UNBLOCK(✗).

4

The TV GUIDELINE has 2 rating methods: Content-Based Rating and Age-Based Rating. The TV GUIDELINE includes the following options: TV-MA Mature Audience only

AGE-BASED		CONTENT-BASED	
RATING	DESCRIPTION	RATING	DESCRIPTION
TV-Y	All children	FV	Fantasy violence
TV-Y7	Directed to children age 7 and older	D	Suggestive dialogue
TV-G	General Audience	L	Strong language
TV-PG	Parental Guidance suggested	S	Sexual situations
TV-14	Parents strongly cautioned		

		CONTENT-BASED				
		FV	D	L	S	V
AGE-BASED	TV-Y					
	TV-Y7	✓				
	TV-G					
	TV-PG		✓	✓	✓	✓
	TV-14		✓	✓	✓	✓
	TV-MA			✓	✓	✓

✓ : To block programs by both content and age.

Use the ▲▼ buttons to select the rating you want and press the OK button repeatedly to select BLOCK(✓) or UNBLOCK(✗).

5

The V-CHIP menu includes the following options:

Block MPAA Rating	Selects to activate the MPAA Rating programs
Block TV Rating	Selects to activate the TV Rating programs.
Block MPAA Unrated	<ul style="list-style-type: none"> ▪ YES: Block all movies that are broadcast without a MPAA rating. ▪ NO: Allows all movies that are broadcast without a MPAA rating
Block TV None Rating	<ul style="list-style-type: none"> ▪ YES: Block all movies that are broadcast without a TV rating. ▪ NO: Allows all movies that are broadcast without a TV rating.

Using the Parental Settings

The Parental blocking can be set up to the TV to block a Channel or a Video Source.

- 1 Use the **▼** button to select the Parental, and press the OK to display the Parental menu.

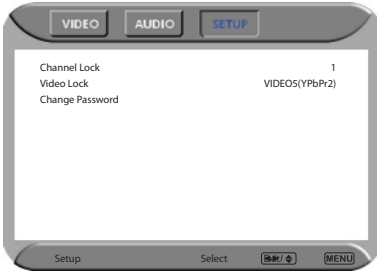

- 2 Use the V-CHIP function, must enter a four-digit password. The factory password is 0000.

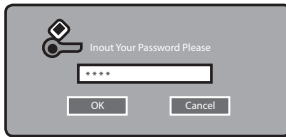

You need your password for any future access into the V-Chip and Parental Setting,

- 3 The Parental menu includes the following options:

Channel Lock Selects to block a TV channel.

Video Lock Selects to block a Input source signal.

Change Password Selects to change your password.

Customizing the TV Settings

- 1 Press the **⏻** button to turn the LCD TV on.
- 2 Press the MENU button on the remote control to display the Main menu, and use the **◀▶** buttons to select the TV.
- 3 Use the **▲▼** buttons to highlight an individual TV option, use the **◀▶** buttons changes the setting, and press the MENU exits the menu.



- 4 The TV menu includes the following options:

Searching	Automatically sets up channel list on TV for all receivable channels.
Tuner Mode	Allows selection between CATV cable and antenna signal sources: <ul style="list-style-type: none"> ▪ ANTENNA Choose this setting if you are receiving TV channels with an antenna cable. ▪ CABLE STD/CABLE IRC/CABLE HRC Choose this setting if you are receiving TV channels with a CATV cable.
Channel Skip	Allows addition/removal of channels on the channel list.
Channel Name	Allows channel labels to be edited.

SPECIFICATIONS

ENGLISH

MODEL		FLM-2632/ FLM-2634B FLM-263B/ FLM-2632M	FLM-3232/ FLM-3234B/ FLM-323B/ FLM-3232M
LCD Panel	Panel Size	26" TFT LCD	32" TFT LCD
	Brightness	550	500
	Contrast Ratio	1000:1	800:1
Max. Resolution		1366x768	1366x768
Input Connector	VIDEO/AUDIO(L/R)	2	2
	S-VIDEO/AUDIO(L/R)	1	1
	YPbPr/AUDIO(L/R)	2	2
	VGA/AUDIO(L/R)	1	1
	HDMI/AUDIO(L/R)	1	1
	AUDIO OUT(L/R)	1	1
	OPTICAL/COAXIAL	1	1
	HEADPHONE	1	1
Power Source		AC100~240V, 50/60HZ, 2.2A	AC100~240V, 50/60HZ, 2.2A
Power Consumption		180 W, standby < 5 W	180 W, standby < 5 W
Dimension		26.7 w x 22.1 h x 7.9 d inch	31.7 w x 25.0 h x 8.4 d inch
WEIGHT		31.97 LB	39.5 LB

MODEL		FLM-3732/FLM-373B/ FLM-3734B/FLX-374/ FLM-3732M	FLM-4034B
LCD Panel	Panel Size	37" TFT LCD	40" TFT LCD
	Brightness	500	500
	Contrast Ratio	1000:1	1200:1
Max. Resolution		1366x768	1366x768
Input Connector	VIDEO/AUDIO(L/R)	2	2
	S-VIDEO/AUDIO(L/R)	1	1
	YPbPr/AUDIO(L/R)	2	2
	VGA/AUDIO(L/R)	1	1
	HDMI/AUDIO(L/R)	1	1
	AUDIO OUT(L/R)	1	1
	OPTICAL/COAXIAL	1	1
	HEADPHONE	1	1
	Power Source		AC100~240V, 50/60HZ, 3.0A
Power Consumption		275 W, standby < 8 W	275 W, standby < 8 W
Dimension		36.6 w x 28.2 h x 9.4 d inch	39 w x29.2 h x 9.4 d inch
WEIGHT		54 LB	60 LB

Chapter 4

Programming your Remote Control

Introduction

Your remote lets you control four devices with one easy-to-use, compact unit. After installing batteries, you can program the remote to control your Universal TV, VCR or DVD, Cable or Satellite Receivers, Amplifier or Tuner, and Auxiliary devices. To do so, follow the instructions in "Programming a Device". For best results, please read and follow all the remaining instructions. Keep this guide for future reference.

A Quick Look at Programming a Device

To control VCR or DVD, Cable or Satellite Receivers, Amplifier or Tuner, and Auxiliary devices, follow these steps. Before proceeding, find the codes for the devices you want to program in "Manufacturer's Codes" on the right side of this page and write them down or highlight them.

NOTE: To program a DVD Player, TV/DVD Combo, TV/VCR/DVD Combo, portable DVD player, or mobile DVD player, use the **DVD** key.

1. Turn on the device (for example, DVD player) and, if needed, load media (for example, a DVD).
2. Press a device key (**VCR/DVD**, **CBL/ SAT**, or **AUX**).
3. Press and hold **SET** until the red LED blinks twice; then release.
4. Enter the first five-digit code for your device. The LED blinks once as each digit is entered. If the code is correct, the LED blinks twice.
 - **NOTE:** If the LED does not blink twice, repeat steps 2 to 4 and try entering the code again.
5. Aim the remote at the device and press **Power**. The device should turn off. If it does not, repeat steps 3–5, trying each code for your brand until you find one that works. If you cannot find a code that works, see "Searching for Your Code".
6. Repeat steps 1–5 for the other devices you want to control. For future reference, write down each working device code below:
 - AUX** Code:
 - CBL** Code:
 - CD** Code:
 - DVD** Code:
 - SAT** Code:
 - TNR** Code:
 - VCR** Code:
7. Press set to save and exit

Searching for your Code

If your device does not respond to the remote after trying all codes listed for your brand, or if your brand is not listed, try searching for your code:

1. Press a device key once.
2. Press and hold **SET** until the red LED blinks twice; then release.
3. Enter **9-9-1**, then the device group number (0= Cable, 1= TV, 2= VCR, 3= Audio). The LED blinks twice.
4. Aim the remote at the device and press **Power**. The remote sends IR codes from its library to the selected device, starting with the most popular code first. If the device responds, go to step 7.
5. If the device does not respond, press **CH+**. The remote will try the next code. Continue until the device responds.
 - **Note:** Press **CH-** to try the previous code.
6. To search for other device codes, repeat steps 1 to 5.
7. Press **SET** to save and exit.

Checking the Codes

If you have set up the remote using the procedure in "Searching for Your Code", you may need to find out which four-digit code is operating your equipment.

For example, to find out which code is assigned to your TV:

1. Press **TV** once.
2. Press and hold **SET** until the red LED blinks twice; then release.
3. Enter **9-9-0**. The LED blinks twice.
4. To view the code for the first digit, press **1**. Count the LED blinks (for example, three blinks = 3), and write down the number in the appropriate code listing in step 8 under "Programming a Device".
 - **NOTE:** If a code digit is **0**, the LED does not blink.
5. Repeat step 4 for the four remaining digits, using **2** for the second digit, **3** for the third digit, **4** for the fourth digit, and **5** for the fifth digit.

Changing Volume Lock

The remote comes preset to allow independent volume control of each selected device (Global Volume Unlock). However, you may change the Volume Lock setting to Global Volume Lock so that one device's volume will control volume in all other modes. After that, you can perform Individual Volume Unlock on a selected device to set its volume control for independent operation or Global Volume Unlock to remove all volume locking.

Locking Volume Control to One Mode (Global Volume Lock)

1. Press and hold **SET** until the red LED blinks twice; then release.
2. Enter **9-9-3** and then press the mode key for the device you want to control volume (for example, **TV**). The LED blinks twice. Now when you press **VOL+**, **VOL-**, or **Mute**, the selected device (for example, **TV**) will control the volume regardless of the current mode.

Unlocking All Volume Control (Restoring Global Unlock)

1. Press and hold **SET** until the red LED blinks twice; then release.
2. Enter **9-9-3** and then press **VOL+**. The LED blinks four times. Volume is now independently controlled for all programmed devices.

Unlocking a Single Device's Volume Control

1. Press a device key (**TV**, **VCR/DVD**, **CBL/SAT**, or **AUX**).
2. Press and hold **SET** until the red LED blinks twice; then release.
3. Enter **9-9-3** and then press **VOL-**. The LED blinks four times. Volume is now independently controlled for the selected devices.

Troubleshooting

PROBLEM: LED does not blink when you press a key.

SOLUTION: Replace battery with new AA size battery.

PROBLEM: LED blinks when you press a key, but device does not respond.

SOLUTION: Make sure the remote is aimed at your device and is not more than 15 feet away.

PROBLEM: LED blinks one long blink.

SOLUTION: An entry error has occurred (for example, wrong key). Try entry sequence again.

PROBLEM: Remote does not control devices or commands are not working properly.

SOLUTION: Try all listed codes for the device. Make sure the device operates with an infrared remote control.

PROBLEM: **CH+**, **CH-**, and **LAST** do not work for your RCA TV.

SOLUTION: Due to RCA design from 1983 to 1987, only the original remote control will operate these functions.

PROBLEM: No volume on a device.

SOLUTION: See "Changing Volume Lock".

PROBLEM: Channels do not change properly.

SOLUTION: If the original remote control required you to press **Enter** to change channels, press **Enter** on this remote after entering the channel number.

MANUFACTURER'S CODES

SETUP CODES FOR Audio Amplifiers

Adcom	0577, 1100
Aiwa	0406
Arcam	0269
Bose	0674
Carver	0892, 0269
Cinema Sound	0160
Curtis Mathes	0300
Denon	0160
Durabrand	1561
Elan	0647
GE	0078
Grundig	0269
Harman/Kardon	0892
JVC	0331
Left Coast	0892
Lenoxx	1561
Linn	0269
Luxman	0165
Magnavox	0269
Marantz	0892, 0269, 0321
McIntosh	0251
Micromega	0269
Modulaire	0395
NEC	0264
Naim	0269
Nakamichi	0321
Optimus	0013, 0300, 0823, 0395
Panasonic	0308, 0521
Pass Labs	0269
Philips	0892, 0269
Pioneer	0013, 0300, 0823
Polk Audio	0892, 0269
RCA	0013, 0300, 0823
RadioShack	0395
Realistic	0013, 0395, 0220
Revox	0269
Sansui	0321
Shure	0264
Sony	0815, 0220, 0689
Soundesign	0078

Technics	0308, 0521
Victor	0331
Wards	0013, 0078
Yamaha	0354, 0133

**SETUP CODES FOR
Cable Converters**

A-Mark	0008, 0144
ABC	0237, 0003, 0008
Accuphase	0003
Acorn	0237
Action	0237
Active	0237
Americast	0899
Archer	0237
BCC	0276
Bell South	0899
British Telecom	0003
Century	0008
Digeo	1187
Director	0476
Fosgate	0276
GE	0144
General Instrument	0476, 0810, 0276, 0003
Gibraltar	0003
GoldStar	0144
Hamlin	0009
Hitachi	0003, 0008, 0009
Insight	0476, 0810
Jerrold	0476, 0810, 0276, 0003
Memorex	0000
Mitsubishi	0003
Motorola	0476, 1376, 0810, 0276, 1187
Nova Vision	0008
Novaplex	0008
Pace	0877, 1877, 0237, 0008
Panasonic	0000, 0008, 0144, 0107
Paragon	0000, 0008, 0525

Penneys	0000
Philips	1305, 0317
Pioneer	0877, 1877, 0144, 0533
Pulsar	0000
Quasar	0000
Regal	0276, 0279
Runco	0000
Samsung	0003, 0144
Scientific Atlanta	0877, 1877, 0477, 0237, 0003, 0000, 0008
Sony	1006
Sprucer	0144
Starcom	0003
Supercable	0276
Time Warner cable	1877
Torx	0003
Toshiba	0000
US Electronics	0276, 0003, 0008
United Cable	0276, 0003
Videoway	0000
Zenith	0000, 0008, 0525, 0899

**SETUP CODES FOR
Miscellaneous Audio**

Altec Lansing	1485
Cambridge Soundworks	1530
Creative	0872
D-Link	1522
Imerge	1491
Integra	1789
Jerrold	0520
Marantz	1491
Motorola	1464
Netgear	1785
Omnifi	1605
Onkyo	1789
SSI	1522
Yamaha	1809, 1810

SETUP CODES FOR Audio Amp/Tuners

ADC	0531
AMC	1077
AMW	1563, 1615
Aiwa	1243, 1405, 1388, 1641, 0189, 0121, 0405, 0158
Akai	1255, 1512, 0244, 0346
Alco	1390
Amphion Media Works	1563, 1615
Anam	1609, 1074
Apex	1257
Apex Digital	1774, 1257, 1430
Arcam	1189, 1120
Audiotronic	1189
Audiovox	1390, 1627
B & K	0820, 0840, 0701, 0702
BK	0702
Bose	1229, 0639, 1253
Brix	1602
Cairn	0189
Cambridge Soundworks	1370
Capetronic	0531, 0195
Carver	1189, 0189, 0121, 1289, 0042, 0360, 0008
Casio	0195
Clarinette	0195
Classic	1352
Coby	1389
Compaq	1136
Criterion	1420
Curtis Mathes	0014, 0080, 0039
Daewoo	1250
Dell	1383
Delphi	1414
Denon	1142, 1360, 1306, 0121, 0004
Emerson	0531, 0195, 0424
Fisher	1801, 0801, 0042, 0360, 0219, 0008

Garrard	0463, 0424
Gateway	1517, 1567
Go Video	1352, 1532
Grundig	0189
Harman/Kardon	0110, 1304, 1306, 0891, 0189, 1289
Hewlett Packard	1181
Hitachi	1273, 1801
Initial	1426
Inkel	0491
Integra	0842, 0135, 1320, 1298
JBL	0110, 1306
JVC	1058, 1374, 1495, 1811, 0074
KLH	1428, 1390, 1412
Kawasaki	1390
Kenwood	1313, 1570, 1569, 0186, 0042, 0239, 0027, 0077
Koss	1497, 1366, 0424
LG	1293
LXI	0181
Lasonic	1798
Lenox	1437
Lexicon	1076
Linn	0189
Liquid Video	1497
Lloyd's	0195
Lloyds	0195
MCS	0039, 0346
Magnavox	1189, 1269, 0531, 1266, 0189, 1514, 0195, 0391, 1120
Marantz	1189, 1269, 0891, 0189, 1289, 1120, 0039
McIntosh	1289
Micromega	1189, 0189
Mitsubishi	1393
Modulaire	0195
Myryad	1189
NAD	0320
Nakamichi	1313, 0097, 1555, 0347
New Castle	0502
Nikko	0322
Nikkodo	0322

Norcent	1389
Nova	1389
Onkyo	0842, 0135, 1320, 1298, 1531
Optimus	1023, 0531, 0014, 1074, 0670, 0121, 0186, 0080, 0195, 0738, 0801, 0042, 0181, 0502, 0219, 0158, 0074, 0163, 0177
Oritron	1497, 1366
Outlaw Audio	0391
Panasonic	1308, 1518, 1548, 1288, 1316, 1763, 1764, 1633, 0309, 0367, 0039
Penney	0195
Penneys	0195, 0039
Philips	1189, 1269, 0891, 1266, 0189, 0391, 1120
Pioneer	1023, 1384, 0531, 0014, 0150, 0630, 0080, 0801, 0244, 0346
Polaroid	1508
Polk Audio	0189, 1289, 1414
Proscan	1254, 0054
Quasar	0039
RCA	1023, 1609, 1254, 0531, 1511, 1390, 1074, 0080,
RadioShack	1609, 0181
Realistic	1609, 0121, 0186, 0195, 0042, 0181, 0158, 0163, 0177
Regent	1437
Revox	0189
Rio	1869, 1383
Rio Audio	1383
Saba	1519
Samsung	1295, 1500
Sansui	1189, 0189, 0346
Sanyo	1801, 1469, 1251, 0801, 0360, 0219
Scott	0322, 0163
Sears	0195, 0424
Sharp	0186, 1286

Sharper Image	1556
Sherwood	1077, 1653, 0491, 0502, 1423
Shinsonic	1426
Siemens	0424
Sirius	1811, 1602, 1627
Sonic Blue	1869, 1532, 1383
Sony	1058, 1441, 1258, 1759, 1758, 1622, 1858, 1658, 1558, 1406, 0405, 0474, 1349, 1442, 0158
Soundesign	0670
Stereophonics	1023
Sunfire	1313
Teac	1267, 1390, 1074, 1528, 0463, 0163
Technics	1308, 1518, 1633, 0309, 0039
Thorens	1189
Toshiba	0842, 0135, 0080
Venturer	1390
Victor	0074
Waitec	1352
Wards	0014, 0189, 0080, 0042, 0054, 0158
XM	1406, 1414
Yamaha	1023, 0176, 1176, 1375, 1331, 1276, 0186
Yorx	0195
Zenith	1293, 0857, 0346

SETUP CODES FOR Satellite Receivers

AlphaStar	0772
Bell ExpressVu	0775
Chaparral	0216
DirecTV	0566, 0639, 1639, 1640, 0247, 0749, 1749, 1142, 1442, 0724, 0819, 1856, 1108, 1609, 0392, 1392, 1076, 0099
Dish Network	0775

Dish Network System	0775, 1775, 1005, 1505
Dishpro	0775, 1775, 1005, 1505
Echostar	0775, 1775, 1005, 1505
Expressvu	0775, 1775
GE	0566, 0392
GOI	0775, 1775
General Instrument	0869
Goodmans	1246
HTS	0775, 1775
Hitachi	1250, 0749, 0819
Houston tracker	0775
Hughes	0749, 1749, 1142, 1442
Hughes Network Systems	0749, 1749, 1142, 1442
Innova	0099
JVC	0775, 1775
Jerrold	0869
LG	1226
Magnavox	0724, 0722
McIntosh	0869
Memorex	0724
Mitsubishi	0749
Motorola	0869, 0856
NEC	1270
Netsat	0099
Next Level	0869
Optimus	0724
Panasonic	0701, 0247
Paysat	0724
Philips	0749, 1749, 1142, 1442, 0775, 0724, 0722, 0819, 1076, 0099
Pioneer	1142, 1442
Primestar	0869
Proscan	0566, 0392
RCA	0566, 1142, 1442, 0775, 0143, 0855, 0392, 1392
RadioShack	0566, 0775, 0869
SKY	0856, 0099

Samsung	1142, 1442, 1276, 1108, 1609
Sanyo	1219
Sony	0639, 1639, 1640
Star Choice	0869
Star Trak	0772, 0869
Thomson	0566, 0392
Tivo	1142, 1442
Toshiba	0749, 1749, 0790, 1285, 0819
UltimateTV	1640, 1392
Uniden	0724, 0722
Voom	0869
Zenith	0856, 1856

SETUP CODES FOR TVs

A-Mark	0047, 0054
AOC	0180, 0030
Accuscan	0047
Action	0030
Admiral	0463, 0180
	0047, 0054, 0017, 0051, 0093
Advent	0761, 0783, 0815, 0817, 0842
Adventuri	0000
Agna	0150
Aiko	0092
Akai	0060, 0702, 0672, 0030, 0145, 0812
Albatron	0700, 0843
Alfide	0672
Alleron	0030
Ambassador	0150
America Action	0180
American High	0000, 0060
Amstrad	0171
Amtron	0000, 0180
Anam	0180
Apex	0156, 0748, 0765
Apex Digital	0156, 0748, 0765, 0879, 0767

Audinac	0180
Audiovox	0451, 0180, 0092, 0623
Aumark	0060
Aventura	0171
Baysonic	0180
Beaumark	0017, 0030, 0178
Belcor	0030
Bell & Howell	0054, 0154, 0093
Bell and Howell	0054, 0154, 0093
BenQ	1756, 1032
Bradford	0180
Brockwood	0030, 0178
Broksonic	0236, 0463, 0180
CXC	0180
Candle	0030
Capehart	0017, 0030, 0178, 0092
Capetronic	0030
Carnivale	0030
Carver	0054
Celebrity	0000
Celera	0765
Changhong	0156, 0765, 0783, 0767
Cineral	0451, 0092
Citek	0047
Citizen	0054, 0000, 0451, 0463, 0180, 0060, 0030, 0092, 0171
Clarion	0180
Classic	0030, 0092
Colortyme	0047, 0054, 0017, 0060, 0030, 0178
Commercial Solutions	0047, 1447
Conic	0178
Contec	0180
Craig	0180, 0171
Crosley	0054, 0000, 0180, 0030, 0171
Crown	0093, 0180, 0672
Crown Mustang	0672

Curtis Mathes 0047, 0054,
 0154, 0000, 0051, 0451, 0093, 0180,
 0060, 0702, 0030, 0178, 0145, 0166,
 1147, 1347
 Daewoo 0451, 1661, 0672,
 0178, 0092, 0623, 1755, 1756, 0661
 Dayton 0092
 Daytron 0030, 0178, 0092
 Dell 1454
 Denon 0511, 0145
 Dumont 0017, 0180, 0178
 Durabrand 0463, 0180,
 0178, 0171, 1034, 1463
 Dwin 0093
 ESA 0171, 0812
 Eaton 0060
 Electroband 0000
 Electrograph 1755
 Electrohome 0154, 0000,
 0150, 0030, 0178
 Emerald 0178
 Emerson 0047, 0154,
 0451, 0236, 0463, 0180, 0150, 0178,
 0171, 0623
 Envision 0030
 Fisher 0054, 0154, 0000
 Fortress 0093
 Funai 0000, 0180, 0171
 Futuretech 0180
 GE 0047, 0000, 0051, 0451,
 0060, 0030, 0178, 1147, 1347, 1447
 Gateway 1755, 1756
 Gemini 0047
 Gibraltar 0017, 0000, 0030
 Gibraltar 0017, 0030
 Go Video 0060
 GoldStar 0047,
 0054, 0030, 0178
 Goodmans 0360
 Gradiente 0053
 Grundig 0672, 0706

Grundy	0180
Grunpy	0180
Haier	1034
Hallmark	0236, 0180, 0178
Harley Davidson	0000, 0180, 0060, 0030, 0178
Harman/Kardon	0054
Harvard	0180
Havermy	0093
Heathkit	0017
Helios	0865
Hello Kitty	0451
Hisense	0748
Hitachi	0047, 0054, 0017, 0000, 0051, 0145, 1145
Hyundai	0865
Ima	0236, 0180, 0178
Infinity	0054
Inteq	0017, 0145
JBL	0054
JCB	0000
JIL	0030
JVC	0054, 0053, 0030, 1253, 0731
Jensen	0761, 0815, 0817
Jutan	0030
KEC	0180, 0060
KLH	0156, 0180, 0765, 0767
KTV	0463, 0180, 0030
Kamp	0017, 0180
Kawasho	0030
Kenwood	0180, 0030
Kloss	0030
Kloss Novabeam	0030
Konka	0180
LG	0442, 0054, 1265, 0060, 0030, 0178, 0700
LXI	0047, 0054, 0017, 0154, 0000, 0156, 0051, 0093, 0060, 0053, 0030, 0178, 0171, 0166, 1347
Lark	0154
Lloyds	0236, 0180, 0030

Logik 0236, 0180
 MGA 0150, 0030, 0178
 MGN Technology 0178
 MTC 0180, 0060, 0030, 0092
 Magnasonic 0054,
 0000, 0156, 0093, 0030, 0092
 Magnavox 0047, 1454, 0054,
 0154, 0000, 0051, 0250, 0180, 0060,
 0030, 0092, 0171, 0706, 1254, 1755
 Majestic 0017
 Marantz 1454, 0054, 0030
 Matsushita 0051, 0250, 0650
 Maxcent 1755, 1756
 Maxent 1755
 Megapower 0700
 Megatron 0047, 0178, 0145
 Memorex 0154, 0463,
 0180, 0150, 0060, 0030, 0178
 Micro Genius 0150
 Midland 0047, 0017, 0051
 Mitsubishi 0154, 0093,
 0150, 1250, 0030, 0178, 0836
 Monivision 0700, 0843
 Motorola 0054,
 0051, 0093, 0150
 Multitech 0180
 NAD 0156, 0178, 0166, 1156, 0866
 NEC 0047, 0030, 0178, 1704
 NTC 0092
 NetTV 1755
 Nikko 0047, 0017,
 0154, 0156, 0030, 0178, 0092, 1347
 Nikkodo 0030, 0178, 0092
 Nishi 0030
 Norcent 0748
 Nyon 0000
 Onwa 0180
 Optimus 0154, 0250, 0093, 0180,
 0150, 0030, 0178, 0166, 0650, 0679

Optonica 0093
 Orion 0017,
 0236, 0463, 0180, 0178, 1463
 PCE 0156, 0060
 Pace 0092
 Panasonic 0047, 0054,
 0154, 0000, 0156, 0051, 0250,
 0093, 0236, 0150, 0060, 0053,
 0030, 0178, 0145, 1347, 0650
 Panda 0706
 Paxonic 0060, 0030
 Penney 0047, 0156,
 0051, 0060, 0030, 0178, 1347
 Penneys 0047, 0000,
 0156, 0051, 0250, 0060, 0030, 0178
 Petters 1523
 Philco 0054, 0463, 0030, 0145
 Philips 1454, 0054, 0017,
 0000, 0030, 0171, 1254, 0690
 Pilot 0051, 0060, 0030, 0178
 Pioneer 0166, 0866, 0679
 Polaroid 0765, 0865, 1523
 Portland 0451, 0092
 Precision 0236, 0180
 Prima 0761, 0783, 0815, 0817
 Princeton 0700
 Prism 0051, 0250
 Proscan 0047,
 0030, 1347, 1447
 Proton 0178
 Pulsar 0017, 0092
 Pulser 0178, 0092
 Quartz 0150, 0178
 Quasar 0051, 0250, 0650
 RCA 0090, 1547, 0047,
 0054, 0000, 0051, 0093, 0178, 1047,
 1147, 1247, 1347, 1447, 0679
 Rabbit 0047
 RadioShack 0047,
 0154, 0180, 0150, 0030, 0178
 Realistic 0047, 0154,
 0180, 0150, 0030, 0178

Runco	0017, 0060, 0030
SR2000	0154, 0171
SSS	0180
SV2000	0054
SVA	0748, 0865
Sampo	0047, 0030, 1755, 1756
Samsung	0047, 0054, 0017, 0154, 0060, 0702, 0030, 0178, 1060, 0812
Sanky	0060, 0030
Sansui	0463, 0060, 0030
Sanyo	0088, 0047, 0054, 0154, 0000, 0463, 0171, 1755
Saville	0060
Scotch	0178
Scott	0236, 0180, 0030, 0178
Sears	0047, 0054, 0017, 0154, 0000, 0156, 0051, 0093, 0060, 0053, 0030, 0178, 0171, 0166
Sharp	0054, 0093, 0180
Sheng Chia	0093
Shivaki	0178
Siemens	0145
Signature	0054
Signature 2000	0047, 0093, 0030
Simpson	0030, 0178
Singer	0060, 0092
Solar Drape	0000
Sony	1100, 0017, 0154, 0000, 0150, 0053
Soundesign	0180, 0178
Spectravision	0156, 0178
Squareview	0171
Starlite	0236, 0180
Studio Experience	0843
Supreme	0000
Sylvania	0047, 0054, 0154, 0000, 0051, 0030, 0178, 0092, 0171
Symphonic	0000, 0180, 0178, 0171
TMK	0236, 0180, 0178
TNCi	0017

TVS	0463
Tandy	0093
Tatung	0000, 0051, 1756
Teac	0154, 0706
Technics	0047, 0054, 0017, 0051, 0250, 1347, 0650
Technovox	0030
Techwood	0051, 0250, 0060
Teknika	0054, 0463, 0180, 0150, 0060, 0178, 0092
Telecolor	0017
Telefunken	0702
Thomas	0047, 0178
Thomson	0047, 1447
Tocom	0156
Toshiba	0154, 0156, 0150, 1265, 0060, 0145, 0166, 1145, 1156, 1256, 1356, 1656, 1704, 0650
Totevision	0051
Toyomenka	0178
Truetone	0051, 0250
Ultra	0092
Universal	0047
V	1755, 1756
Vector Research	0030
Victor	1100, 0053
Vidikron	0054
Vidtech	0178
Viewsonic	1755
Viking	0060
Visio	1755, 1756
Vizio	1756
Wards	0047, 0054, 0017, 0154, 0000, 0156, 0051, 0093, 0236, 0180, 0060, 0030, 0178, 0166, 1147, 1347, 1156, 0866
Waycon	0156
Welton	0178
Westinghouse	0451

White Westinghouse 0451, 0236, 0463, 0623
 World 0451, 0236, 0463, 0180
 XR1000 0154, 0180, 0171
 Yamaha 0030
 Yorx 0030
 Zenith 0047, 0017, 0000,
 0093, 0463, 0030, 0178, 0145,
 0092, 0171, 1145, 0812

SETUP CODES FOR VCRs

A-Mark 0000, 0037, 0240
 ABS 1972
 Admiral 0209, 0060,
 0048, 0039, 0047, 0104
 Adventura 0000, 0037, 0240
 Adyson 0072
 Aiwa 0124, 0000, 0037
 Akai 0175, 0041
 Alba 0209, 0072
 Alienware 1972
 Allegro 0039
 American High 0035, 0081
 Amstrad 0000
 Asha 0240
 Astra 0035, 0240
 Audiovox 0037
 Avis 0000, 0072
 Beaumark 0240
 Bell & Howell 0000, 0035,
 0048, 0039, 0104
 Bell and Howell 0000, 0035,
 0048, 0039, 0104
 Broksonic 1479, 0184, 0121, 0209
 CCE 0072
 Calix 0037
 Candle 0037
 Canon 0035
 Carrera 0240
 Carver 0035, 0081

Citizen	1278, 0000, 0035, 0037, 0240, 0209
Classic	0037
Colortyme	0035, 0060, 0045
Colt	0000, 0072
Craig	0037, 0047, 0240, 0072
Criterion	0000, 0072
Crosley	0000, 0035, 0081
Crown	0072
Curtis Mathes	1035, 0000, 0035, 0060, 0162, 0240, 0041
CyberPower	1972
Cybernex	0240
Daewoo	1278, 0037, 0045
Daytron	0037
Dell	1972
Denon	0081, 0042
Derwant	0041
DirecTV	0739
Dual	003, 0000
Durabran	9
Dynatech	0000, 0240
Electrohome	0000, 0060, 0037, 0240, 0043, 0209
Electroponic	0037
Emerald	0184, 0121
Emerex	0032
Emerson	1479, 1278, 0000, 0037, 0184, 0240, 0121, 0043, 0209
Fisher	0000, 0039, 0047, 0104
Fuji	0035, 0033
Fujitsu	0000
Funai	0000, 0037, 0072
GE	1035, 1060, 0807, 0000, 0035, 0060, 0048, 0240
Garrard	0000
Gateway	1972
Gemini	0060
Genexxa	0000, 0037
Go Video	0614, 0240
GoldStar	1237, 0000, 0035, 0037, 0039

Granada	0081, 0042
Grundig	0081
HI-Q	0000, 0035, 0047
HP	1972
Harley Davidson	0000
Harman/Kardon	0081
Harvard	0072
Harwood	0072
Hewlett Packard	1972
Hitachi	0089, 0000, 0035, 0037, 0045, 0042, 0041
Howard Computers	1972
Hughes Network Systems	0739, 0042
Humax	0739
Hush	1972
Hytek	0000, 0047, 0072
ITT Nokia	0240, 0041
JVC	0067, 0041
Janeil	0240
Jensen	0067, 0041
KEC	0037
KLH	0072
KTV	0000
Kenwood	0067, 0041
Kodak	0035, 0037
LG	0037, 0240
LXI	0000, 0037, 0042, 0067
Linksys	1972
Lloyd's	0000
Lloyds	0000, 0240, 0072
Loewe	0081
Logik	0000, 0240, 0072
M Electronic	0240
MEI	0035
MGA	0060, 0240, 0043
MGN Technology	0240
MTC	0000, 0240, 0072
MTC	0000, 0240, 0072
MTX	0000
Magnasonic	1278, 0000, 0037, 0240, 0072

Magnavox 1781, 0000, 0618,
 0035, 0037, 0048, 0039, 0081,0240
 Magnin 0035, 008,0240
 Marant1
 Marta 0037
 Matsui 0037, 0209
 Matsushita 0035, 0081, 0162
 Media Center PC 1972
 Memorex 1237, 0000, 0035,
 0037, 0048, 0039, 0047, 0162,
 0240, 0104, 0209, 0072
 Metz 0037
 Microsoft 1972
 Midland 0240
 Mind 1972
 Minolta 0042
 Mitsubishi 0807,
 0000, 0060, 0048, 0047,
 0042, 0067, 0043,0041
 Motorola 0035, 0048
 Movie Walker 0072
 Multitech 0000, 0039, 0072
 NAD 0240, 0104
 NAP 0035,
 0037, 0039, 0033, 0042
 NEC 0067, 0104, 0041
 Newtech 0072
 Nikko 0037
 Nikkodo 0037
 Nishi 0240
 Niveus Media 1972
 Noblex 0240
 Northgate 1972
 Olympus 0035, 0162, 0104
 Onkyo 0222
 Optimus 0000, 0035, 0037,
 1062, 0048, 0047, 0162, 0240,
 Orion 1479, 0000,
 0184, 0240, 0104, 0121, 0209
 Panama 0035

Panasonic 0225, 1035, 0000,
 0614, 0616, 0035, 1062, 0162
 Penney 1237, 1035,
 0035, 0037, 0042, 0240
 Penneys 0000, 0035, 0037,
 0047, 0081, 0162, 0042, 0067, 0240
 Pentax 0042
 Philco 0000, 0035, 0081, 0209
 Philips 0000, 0616, 0618, 0739,
 0035, 0048, 0081, 0162, 0045, 0209
 Pilot 0037
 Pioneer 0081, 0162, 0042, 0067
 Polk Audio 0081
 Profitronic 0240
 Proscan 1060, 0060
 Protec 0000, 0072
 Protech 0072
 Pulsar 0039, 0240
 Pulser 0240
 Quartz 0035, 0047
 Quasar 1035, 0035, 0162
 RCA 1035, 1060,
 0807, 0000, 0880, 0035,
 0060, 0048, 0045, 0042, 0240
 RadioShack 0000, 0035, 0037,
 0048, 0047, 0162, 0240, 0104
 Radix 0037
 Randex 0037
 Realistic 0000, 0035, 0037,
 0048, 0047, 0162, 0240, 0104, 0121
 ReplayTV 0614, 0616
 Ricavision 1972
 Runco 0039
 STS 0042
 SV2000 0000, 0072
 SVA 0000

Samsung 0000,
 1014, 0739, 0060, 0045, 0240
 Samtron 0240
 Sanky 0048, 0039
 Sansui 1479, 0000,
 0067, 0240, 0209, 0041, 0072
 Sanyo 0159,
 0000, 0047, 0240, 0104
 Scott 0184, 0045, 0121, 0043
 Sears 1237, 0000, 0035, 0060,
 0037, 0048, 0039, 0047,
 0033, 0162, 0045, 0042,
 0067, 0104, 0043, 0209, 0041, 0072
 Sharp 0807, 0000,
 0048, 0047, 0032
 Shintom 0000,
 0039, 0240, 0072
 Shogun 0240
 Siemens 0037, 0104
 Signature 0035
 Signature 2000 0000, 0035,
 0060, 0037, 0048
 Singer 0037, 0240, 0072
 Sonic Blue 0614, 0616
 Sony 1232, 0000, 0636,
 1972, 0035, 0047, 0032, 0033, 0067
 Soundmaster 0000
 Stack 9 1972
 Sylvania 1781, 0000,
 0035, 0081, 0043
 Symphonic 0000, 0240
 Systemax 1972
 TMK 0000, 0240
 TNIX 0037
 Tagar Systems 1972
 Tandy 0000, 0104
 Tatung 0000, 0048,
 0081, 0067, 0041
 Teac 0000, 0067, 0041
 Technics
 0000, 0035, 0060, 0037, 0039, 0162
 Teknika 0000, 0035, 0037
 Telecorder 0240

Telefunken	0041
Thomas	0000
Thomson	0060, 0041
Tivo	0618, 0636, 0739, 1503
Tocom	0240
Toshiba	0845, 1145, 0000, 1503, 1008, 1972, 0045, 0240, 0043, 0209, 0041
Totevision	0037, 0240
Touch	1972
Trix	0037
Ultra	0045
Unitech	0240
Vector	0045
Vector Research	0184
Vextra	0072
Victor	0067, 0041
Video Concepts	0045
Videomagic	0037
Videosonic	0000, 0240, 0072
Viewsonic	1972
Villain	0000
Voodoo	1972
Wards	0000, 0035, 0060, 0037, 0048, 0039, 0047, 0081, 0033, 0045, 0042, 0240, 0043, 0041, 0072
White Westinghouse	0000, 0209, 0072
World	0209
XR-1000	0000, 0035, 0072
XR1000	0000, 0035, 0240, 0072
Yamaha	0041
ZT Group	1972
Zenith	1479, 0000, 0037, 0039, 0033, 0209, 0041
iBUYPOWER	1972

SETUP CODES FOR DVD Players

3D LAB	0503, 0539
Advent	1016
Aiwa	0641
Akai	0899, 0770, 0705
Alba	0672, 0717
Alco	0790
Allegro	0869
Apex	0533, 0672, 1056, 1061, 0830, 0794, 0796, 0797, 1100, 1020, 0717, 0755
Apex Digital	0672, 1056, 1061, 0830, 0794, 0796, 0797, 1100, 1004, 1020, 0717, 0755
Aspire Digital	1168
Audiovox	0790, 0717, 1071, 1121, 1122
Axion	1071
Blaupunkt	0717
Blue Parade	0571
Blue Sky	0695, 0699
Brandt	0651
Broksonic	0695, 0868
California Audio Labs	0490
Celestial	1020
Centrex	0672, 1004
CineVision	0869, 0876, 0833
Cinea	0831
Citizen	1003, 1277
Clairtone	0571
Coby	0778, 1107
Craig	0831
Creative	0503, 0539
Curtis Mathes	1087
CyberHome	0816, 1023, 1117, 1024, 1129, 0874
Cytron	0705
DVD2000	0521
Daewoo	0869, 1172, 0784, 0770, 1169, 0705, 0833

Dansai	0770
Decca	0770
Denon	0490, 0634
Denver	0778
DiViDo	0705
Digitrex	0672
Disney	0675, 1270
Dual	0675
Durabrand	1127
Electrohome	1003
Emerson	0675, 0821, 1268, 0591
Enterprise	0591
Entivo	0503, 0539
Enzer	0770
Firstline	0651
Fisher	0670
Funai	0675, 1268, 1334
GE	0522, 0717, 0815
GPX	0699
Gateway	1158, 1073
General Electric	0717
Go Video	0573, 1075, 1044, 0744, 0717, 0869, 0741, 0783, 1158, 1099, 1304, 1730, 0833, 0715
Go Vision	1071
GoldStar	0801, 0869, 0741
Goodmans	0790
Gradiente	0490, 0651
Greenhill	0717
Grundig	0539, 0705
Harman/Kardon	0582, 0702
Hitachi	0573, 0664, 1247
Hiteker	0672
IRT	0783
Initial	0717
Integra	0571, 0627
JBL	0702
JMB	0695
JVC	0623, 1164, 0558, 0867
Jensen	1016
KLH	1020, 0790, 0717, 1149

KLH Digital	0717
Kawasaki	0790
Kenwood	0490, 0534
Kloss	0533
Koss	1061, 0651
LG	0801, 0591, 0869, 0741
Lasonic	0798, 0627
Lecson	1533
Lenoxx	1127
Lite-On	1058, 1158
LiteOn	1058, 1158, 1416, 1440
Loewe	0511, 0741
Logix	0783
Magnasonic	0675, 0651
Magnavox	0503, 0539, 0675, 0646, 0821
Marantz	0503, 0539, 0675
McIntosh	1533
Medion	0651
Memorex	0695, 1270, 0831
Microsoft	0522
Minato	0752
Mintek	0717, 0839
Mitsubishi	0521, 1521
NAD	0591, 0741
NEC	0785, 0869
Naiko	0770
Nesa	0717
NexxTech	1402
Norcent	1003, 1107
Onkyo	0792, 0503, 0627
Optimus	0571
Orion	0695
Oritron	0651
Palsonic	0672
Panasonic	0503, 0490, 1762, 0703, 1362, 1462, 1490, 0571
Philips	0503, 0539, 0675, 1267, 0646, 0854, 1354, 1260
Phonotrend	0699
PianoDisc	1024
Pioneer	0571, 0525, 0631
Polaroid	1061, 1020
Polk Audio	0539

Portland	0770
Prima	1016
ProVision	0778
Proceed	0672
Proscan	0522
Prosonic	0699
Qwestar	0651
RCA	0522, 0571, 0822, 1132, 1022, 0790, 0717
RadioShack	0571
Radionette	0741
Realistic	0571
Reoc	0752
Revoy	0699
Rio	0869
Rotel	0623
Rowa	1004, 0823
SVA	0717
Saba	0651
Sampo	0752
Samsung	0490, 0573, 0820, 1075, 0899, 1044, 0744
Sansui	0695
Sanyo	0695, 0675, 0670, 1334, 0873
Schneider	0783
Schwaiger	0752
Sensory Science	1158
Sharp	0675, 1256, 0752, 0630
Sharper Image	1117
Sherwood	0770, 1043
Shinsonic	0533, 0839
Slim Art	0784
Sonic Blue	0573, 0869, 0783, 1099, 0715
Sony	0533, 1033, 1431, 0864, 1533
Sova	1122
Superscan	0821
Sylvania	0675, 0821, 1268, 0630
Symphonic	0675, 0821, 1268, 1334
Tatung	0770
Teac	0809, 0571, 0790, 0717

Technics	0490, 0703
Technika	0770
Tevion	0651
Theta Digital	0571
Thomson	0511, 0522
Toshiba	0503, 0695, 1045, 1154, 0573, 0539
US Logic	0839
USLogic	0839
Unimax	0770
Universum	0591
Urban Concepts	0503, 0539
Venturer	0790
Wesder	0699
Xbox	0522
Yamaha	0490, 0539, 0545
Zenith	0503, 0591, 0869, 0741
Zeus	0784
iLo	1348

CARE

- **Keep the remote dry. If it gets wet, wipe it dry immediately.**
- **Use and store the unit only in normal temperature environments.**
- **Handle the remote gently and carefully. Don't drop it.**
- **Wipe the remote with a damp cloth to keep it looking like new.**

Manufactured under license from Dolby Laboratories.
“Dolby” and the double-D symbol are trademarks of Dolby Laboratories.
Confidential unpublished works. © 1992 -1997 Dolby Laboratories, Inc.
All rights reserved.

**“Polaroid” and “Polaroid and Pixel” are trademarks
of Polaroid Corporation, Waltham, MA, USA.**

**For service, support and warranty information, visit
www.polaroid.com.**

Free Manuals Download Website

<http://myh66.com>

<http://usermanuals.us>

<http://www.somanuals.com>

<http://www.4manuals.cc>

<http://www.manual-lib.com>

<http://www.404manual.com>

<http://www.luxmanual.com>

<http://aubethermostatmanual.com>

Golf course search by state

<http://golfingnear.com>

Email search by domain

<http://emailbydomain.com>

Auto manuals search

<http://auto.somanuals.com>

TV manuals search

<http://tv.somanuals.com>