

# 15" HD-Ready LCD TV/DVD Combo with AC/DC Compatibility FXM-1511C



20060331

# Table Of Contents

<b>Important Safety Instructions</b> -----	<b>2</b>
<b>Product Features</b> -----	<b>4</b>
<b>Disc Information</b> -----	<b>5</b>
<b>Front Panel</b> -----	<b>6</b>
<b>Rear Panel</b> -----	<b>8</b>
<b>Remote Control</b> -----	<b>9</b>
<b>System Connections</b> -----	<b>12</b>
Connecting to External AV Signal Source-----	12
Connecting to External AV Signal Source (YPbPr) -----	13
Connecting to External AV Device (AV Out) -----	14
Connecting to PC -----	15
Connecting to Earphone -----	16
Connecting to Power Supply-----	16
Connecting to Car Adapter-----	17
Connecting to TV Antenna-----	18
<b>TV Setup and Operation</b> -----	<b>19</b>
Preparations-----	19
Image Setting-----	19
Audio Setting-----	20
Sleep Setting-----	21
Parental Setting-----	22
Setup Setting-----	25
<b>DVD System Setup</b> -----	<b>28</b>
<b>DVD Play Operation</b> -----	<b>34</b>
<b>USB and SD/MS/MMC Card Function</b> -----	<b>39</b>
<b>Other Functions</b> -----	<b>40</b>
External AV Input Function-----	40
Computer Screen Function-----	40
<b>Troubleshooting</b> -----	<b>41</b>
<b>Specifications</b> -----	<b>42</b>

# Important Safety Instructions

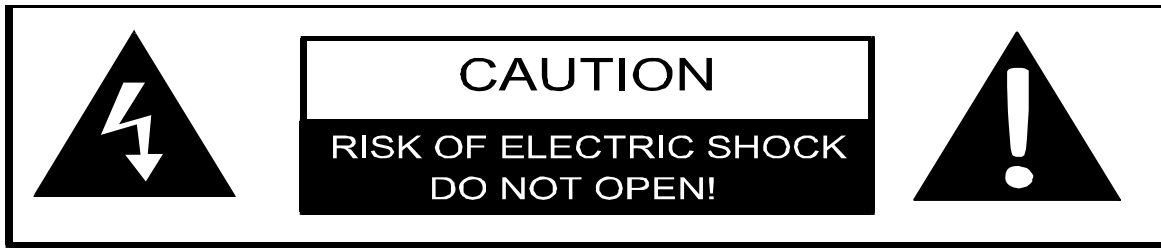

The lightning flash with arrowhead symbol, within an equilateral triangle, is intended to alert the user to the presence of un-insulated “dangerous voltage” within the product’s enclosure that may be of sufficient magnitude to constitute a risk of electric to persons.



The exclamation point within an equilateral triangle is intended to alert the user to the presence of important operating and maintenance (servicing) instructions in the literature accompanying the appliance.



**CAUTION: Laser radiation when open. Do not stare into beam.**

**CAUTION: USE OF ANY CONTROLS, ADJUSTMENTS, OR PROCEDURES OTHER THAN THOSE SPECIFIED HEREIN MAY RESULT IN HAZARDOUS RADIATION EXPOSURE.**

## **POWER SUPPLY:**

Connect the supplied adapter to the side of the DVD player in the slot marked “Power In”. Plug the two-prong end of the power cord to an AC100-240V outlet. If you have difficulty inserting the plug, turn it over and reinsert it, if the unit will not be used for a long time, disconnect the plug from the outlet.

## **NOTE:**

Before plugging the power cord into an AC outlet, make sure that all the connections have been made.

**CAUTION:** These servicing instructions are for use by qualified service personnel only. To reduce the risk of electric shock, do not perform any servicing other than that contained in the operating instructions unless you are qualified to do so.

Refer to service manual for servicing instructions.

# Important Safety Instructions

## **Note:**

1. Read these instructions.
2. Keep these instructions.
3. Heed all warnings.
4. Follow all instructions.
5. Do not use near water.
6. Clean only with a dry cloth.
7. Do not block any ventilation openings. Maintain well ventilated conditions around the product. Do not put product on bed, sofa or anything that blocks ventilation. Install in accordance with the manufacturer's instructions.
8. Do not install near any heat sources such as radiators, heat registers, stoves, or other apparatus (including amplifiers) that produce heat.
9. Do not defeat the safety purpose of the polarized or grounding-type plug. A polarized plug has two blades with one wider than the other. If the provided plug does not fit into your outlet, consult an electrician for replacement of the obsolete outlet.
10. Protect the power cord from being walked on or pinched particularly at plugs, convenience receptacles, and the point where they exit from the apparatus.
11. Only use attachments/accessories specified by the manufacturer.
12. Use only with the cart, stand, tripod, bracket, or table specified by the manufacturer, or sold with the apparatus. When a cart is used, use caution when moving the cart/apparatus combination to avoid injury from tip-over.
13. Unplug this apparatus during lightning storms or when unused for long periods of time.
14. Refer all servicing to qualified service personnel. Servicing is required when the apparatus has been damaged in any way, such as power-supply cord or plug is damaged, liquid has been spilled or objects have fallen into the apparatus, the apparatus has been exposed to rain or moisture, does not operate normally, or has been dropped.
15. Apparatus shall not be exposed to dripping or splashing and no objects filled with liquids, such as vases, shall be placed on the apparatus.

### **IMPORTANT FOR LASER PRODUCTS**

#### **1. CLASS 1 LASER PRODUCT**

**2. DANGER:** Visible laser radiation when open and interlock failed or defeated. Avoid direct exposure to beam.

**3. CAUTION:** Do not open the top cover. There are no user serviceable parts inside the unit. Leave all servicing to qualified service personnel.



**Note: Do not touch the color TFT LCD screen by hand directly.**

## **Copyright Protection**

This product incorporates copyright protection technology that is protected by U.S. patents and other intellectual property rights. Use of this copyright protection technology must be authorized by Macrovision, and is intended for home and other limited viewing uses only unless otherwise authorized by Macrovision. Reverse engineering or disassembly is prohibited.

# Product Features

This product incorporates a DVD player, LCD display and TV receiver in one system.

## **Multiple Modes**

**DVD mode**

**Component mode**

**VGA mode**

**TV mode**

**COMPOSITE mode**

**S-VIDEO mode**

## **High Quality Property**

### **High Resolution**

Adopt an MPEG2 decoding format to achieve horizontal resolution more than 500 lines.

### **LCD (Liquid Crystal Display)**

Designed with 15" color TFT liquid crystal display clearly shows the data.

### **Stereo amplifier**

Built-in 2x3w speakers provide high quality sound.

### **AV and VGA Input**

Can be connected to external audio and video signal source and PC.

### **AV Output**

Can be connected to external audio and video device.

### **Special Function**

Supports sleep time setting, V-Chip and CCD function.

### **Multi-audio and Multi-video modes**

Support multi-audio and multi-video modes, provide more selecting.

### **USB and CARD PORTS**

Designed with USB and SD/MS/MMC card port, can be connected to USB device or SD/MS/MMC Card.

### **Auto TV Searching Function**

Can be connected to the TV antenna, support Auto and manual TV programs searching function.

### **MTS (Multi-Channel Sound) Function**

Supports the MTS function. According to the broadcasting programs, you can choose the corresponding soundtrack.

## **Advanced Playing Features**

### **Compatibility**

DVD, CD, CD-R, CD-RW and JPEG compatible.

### **Zoom Function**

Enlarge the picture to enhance your enjoyment.

### **All Playback Functions**

Fast forward and reverse, slow playback and repeat playback.



### **Special playback.**

Support multi-angle, multi-language and multi-subtitle playback.

**NOTE:** It is normal for a TFT screen to experience some light or dark spots appearing on the LCD screen.

# Disc Information

## Discs Formats Supported By This Player

	DISC LOGO	CONTENTS	SIZE	MAXIMUM TIME
DVD		Audio+Video (active picture)	12cm	133min(SS-SL)
				242min(SS-DL)
				266min(DS-SL)
				484min(DS-DL)
CD		Audio	12cm	74min
JPEG		Still high resolution	12cm	

- The operating method of some DVD discs is specified by the software maker. Please refer to the instruction manual of the disc.

## About Disc Terms

### **Title**

Generally, pictures or music compressed on a DVD are divided into several sections, "title".

### **Chapter**

The smaller section unit of picture or music in a DVD under the title, usually one title is comprised of one or more chapters and each of them is numbered for easy searching. But some discs may not have a recording chapter.

### **Track**

A segment of picture or music on a CD. Each track is numbered for searching.

# Front Panel

---

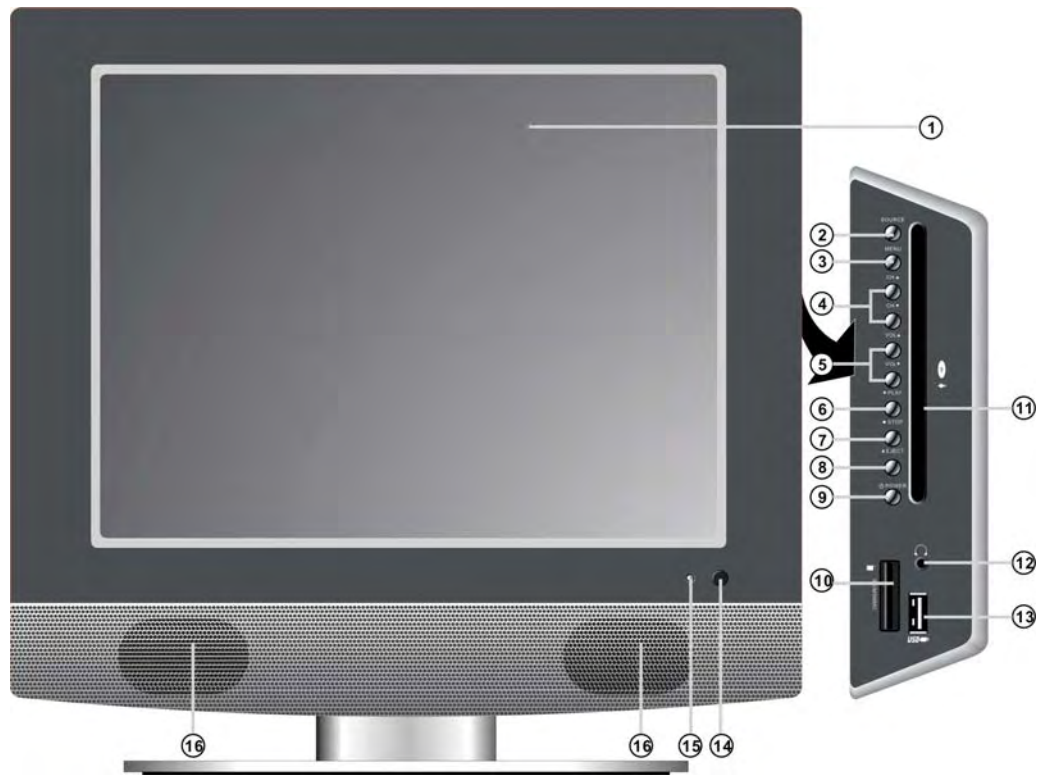

- 1. 15" color TFT screen**  
High resolution 15" color TFT screen clearly show your images.
- 2. SOURCE button**  
Press to select the modes: DVD, Component, VGA, TV, COMPOSITE or S-VIDEO.
- 3. MENU button**  
Press to enter or exit setup menu.
- 4. CH▲/▼ button**  
In the TV mode, press to select channels.  
In setup menu, the same function as ▲/▼ direction buttons.
- 5. VOL▲/▼ button**  
In the TV mode, press to decrease or increase the volume.  
In setup menu, the same function as ◀/▶ direction buttons.  
In setup menu, the VOL▲ has the same function as ENTER button.
- 6. ▶ PLAY button**  
Press to play the disc in DVD mode.

# **Front Panel (Continued)**

---

**7. ■ STOP button**

Press to stop playback, then press the PLAY button to resume normal playback in DVD mode.  
Press the STOP button twice to stop playback completely.

**8. Eject button**

Press to eject the disc out.

**9. Power button**

Press to enter or exit the standby mode.

**10. SD/MS/MMC Card Port**

Insert the SD, MS or MMC card into the port.

**11. Disc Tray Slot**

Used to load disc into the unit.

**12. Earphone Jack**

When connected to earphone, the internal speakers will automatically turn off.

**13. USB Connecting Port**

Connecting to the USB device.

**14. Remote Sensor**

Remote sensor window for the remote control.

**15. Power Indicator**

In normal playback status, it is blue; in standby mode, it turns red.

**16. Speakers**

Two speakers output high quality stereo sound.



# Rear Panel

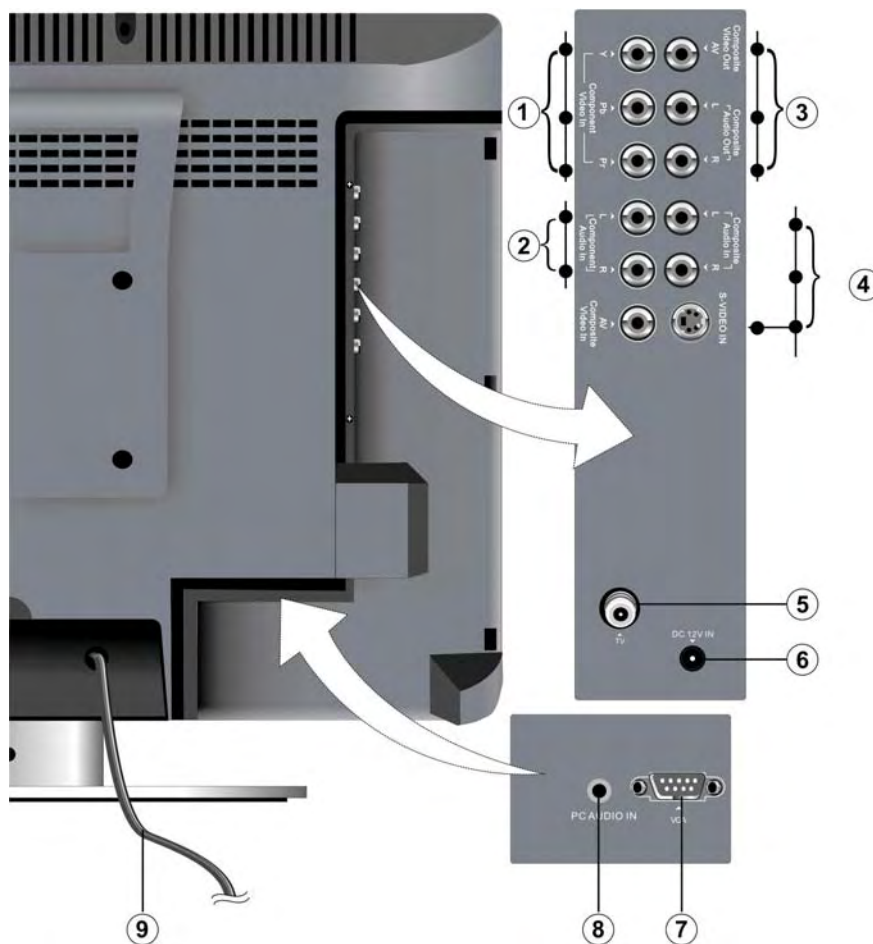

**1. Y/Pb/Pr Input Jack (Component)**

Connected to the Y/Pb/Pr input in Component mode.

**2. L/R Audio Input Jack**

Connected to the L/R audio input in Component mode.

**3. AV Output Jacks**

Connected to the external AV input device.

**4. AV and S-Video Input Jacks**

In the S-VIDEO mode, connected to S-VIDEO signal input.

In the COMPOSITE mode, connected to the external video signal input.

The L/R audio input jacks can be used in the both S-VIDEO and COMPOSITE

modes.

**5. TV Signal Input Jack (RF)**

Connected for the external NTSC TV signal input.

**6. DC 12V In Jack**

Connected to power adapter.

**7. VGA Input Jack**

Connected to the VGA output jack on a personal computer.

**8. PC AUDIO Input Jack**

Connected to the PC audio output jack.

**9. Power Supply Cord**

# Remote Control

## Preparation of Remote Control

Softly push the back cover to open the battery compartment.

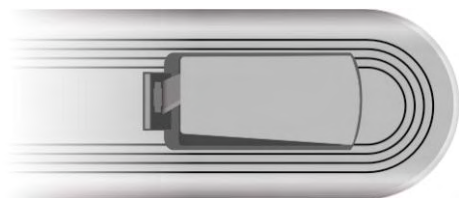

Insert two batteries (1.5V, size AAA), please make sure the polarity matches the marks inside the compartment.

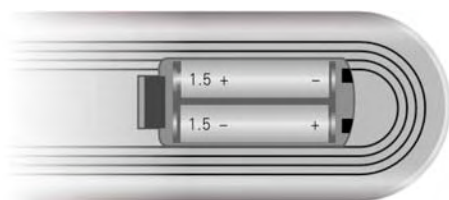

Softly press the back cover to close it.

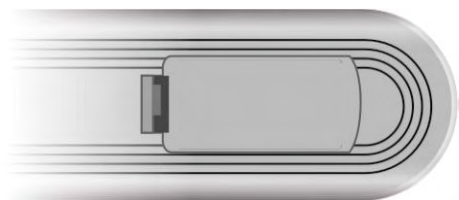

- Under normal use the battery will last for six months.
- Take out battery when the remote is not in use for a long time.

## Using the Remote control

Point the remote control unit from no more than about 7m from the remote control sensor and within about 60 degrees of the front of the unit.



- The operating distance may vary depending to the brightness around.

### **Notes:**

- Do not point bright lights directly at the remote control sensor.
- Do not place objects between the remote control unit and the remote control sensor.
- Do not use this remote control unit while simultaneously operating the remote control unit of any other equipment.

# Remote Control

## Basic Operation

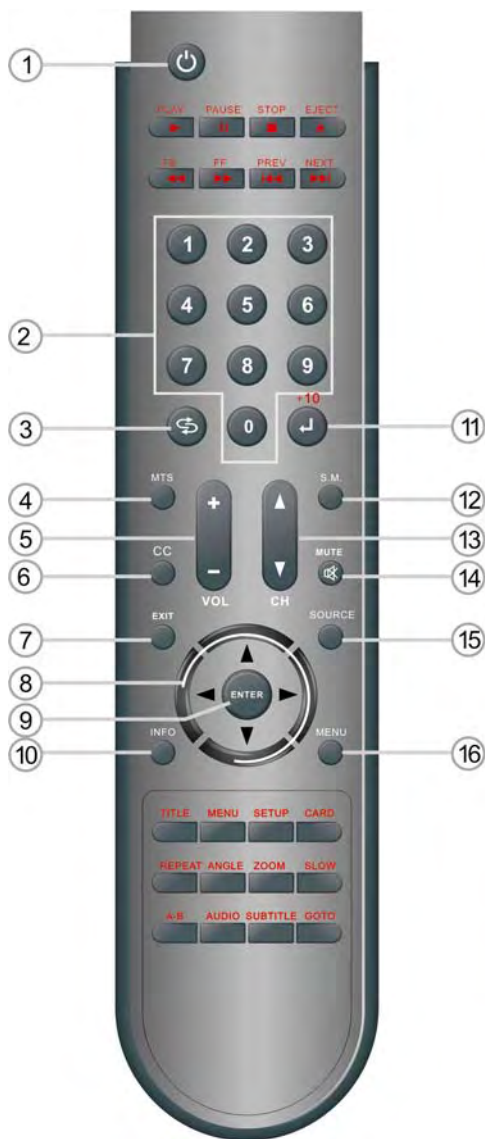

- 1. POWER button**  
Press to enter or exit the standby mode.
- 2. 0~9 Number buttons**  
Press to select numbers.
- 3. LAST button**  
In the TV mode, press to return to the channel last viewed.
- 4. MTS button**  
Press to activate MTS function in TV mode.
- 5. VOL +/- button**  
Press to increase or decrease the volume.
- 6. CC button**  
In TV or COMPOSITE mode, press to display closed captions or cancel display.
- 7. EXIT button**  
Press to exit the setup menu.
- 8. Direction buttons (▲▼◀▶)**  
In the setup menu, press the ▲▼ button to select the desired item and press the ◀▶ button to adjust or set.
- 9. ENTER button**  
Press to confirm your selection.
- 10. INFO button**  
Press to display the information about current status on the screen.
- 11. +10/↵ button**  
In DVD mode, press to select number greater than 10.  
In TV mode, when select the 1~99 channel, press this button to confirm and enter the selected channel.
- 12. S.M. button**  
Press to select audio mode.
- 13. CH ▲/▼ button**  
In TV mode, press to select channel.
- 14. MUTE button**  
Press to turn on or off the speaker output.
- 15. SOURCE button**  
Press to select the mode DVD, Component, VGA, TV, COMPOSITE or S-VIDEO.
- 16. MENU button**  
Press to enter the LCD setup menu.

# Remote Control

## For DVD Operation



1. **▶ PLAY button**  
Press to play the disc in DVD mode.
2. **PAUSE button**  
In DVD mode, press to pause the playback or start step-by-step playback. Then press the PLAY button to resume normal playback.
3. **◀◀FB button**  
Press the ◀◀FB to search backward in DVD mode.
4. **▶▶FF buttons**  
Press the ▶▶FF to search forward in DVD mode.
5. **0~9 Number buttons**  
Press to select numbers.
6. **Direction buttons (▲▼◀▶)**  
In the setup menu, press the ▲▼ button to select the desired item and press the ◀▶ button to adjust or set.
7. **ENTER button**  
Press to confirm your selection.
8. **TITLE button**  
When a DVD disc is playing, press to go to title menu if the disc contains.
9. **MENU button (in DVD mode)**  
Press to enter the disc menu in DVD mode.
10. **REPEAT button**  
Press to repeat a chapter, track, title or all content in DVD mode.
11. **ANGLE button**  
Press to select various camera angles (if the DVD disc contains multiple camera angles).
12. **A-B button**  
Press to mark a segment to repeat between A and B during DVD disc playback.
13. **AUDIO button**  
Press to select different audio languages during a multiple audio language DVD disc playback in DVD mode.
14. **Eject button**  
Press to eject the disc out.
15. **■ STOP button**  
Press to stop playback in DVD mode.
16. **▶▶NEXT button**  
Press the ▶▶NEXT to skip to the next chapter/track for some discs in DVD mode.
17. **◀◀PREV buttons**  
Press the ◀◀PREV to skip to the previous chapter/track for some discs in DVD mode.
18. **CARD button**  
Press to shift to USB or CARD mode when there is the input source.
19. **SETUP button(in DVD mode)**  
Press to enter the DVD setup menu in DVD mode.
20. **SLOW button**  
Press to active slow playback function in DVD mode.
21. **ZOOM button**  
Press to zoom in or out the picture in DVD mode.
22. **GOTO button**  
Press to access or exit the time-searching mode under DVD mode.
23. **SUBTITLE button**  
Press to select different subtitle languages during a multiple language DVD disc playback in DVD mode.

# System Connections

---

- Do not connect the power cord to the unit until all other connections have been made.
- Ensure that you observe the color cord when connecting audio and video cables.

## Connecting to External AV Signal Source

Use the audio and video cable to connect the AV input jacks on the rear panel of the unit to the external AV signal source.

Use the S-VIDEO cable to connect the S-VIDEO input jack on the rear panel of the unit to the external AV signal source.

After connection, turn on the power of the unit and the external AV signal source. Press the SOURCE button of the remote or the unit and select COMPOSITE or S-VIDEO as the input mode.

Note: the L/R audio input jacks can be used in the both COMPOSITE and S-VIDEO modes.

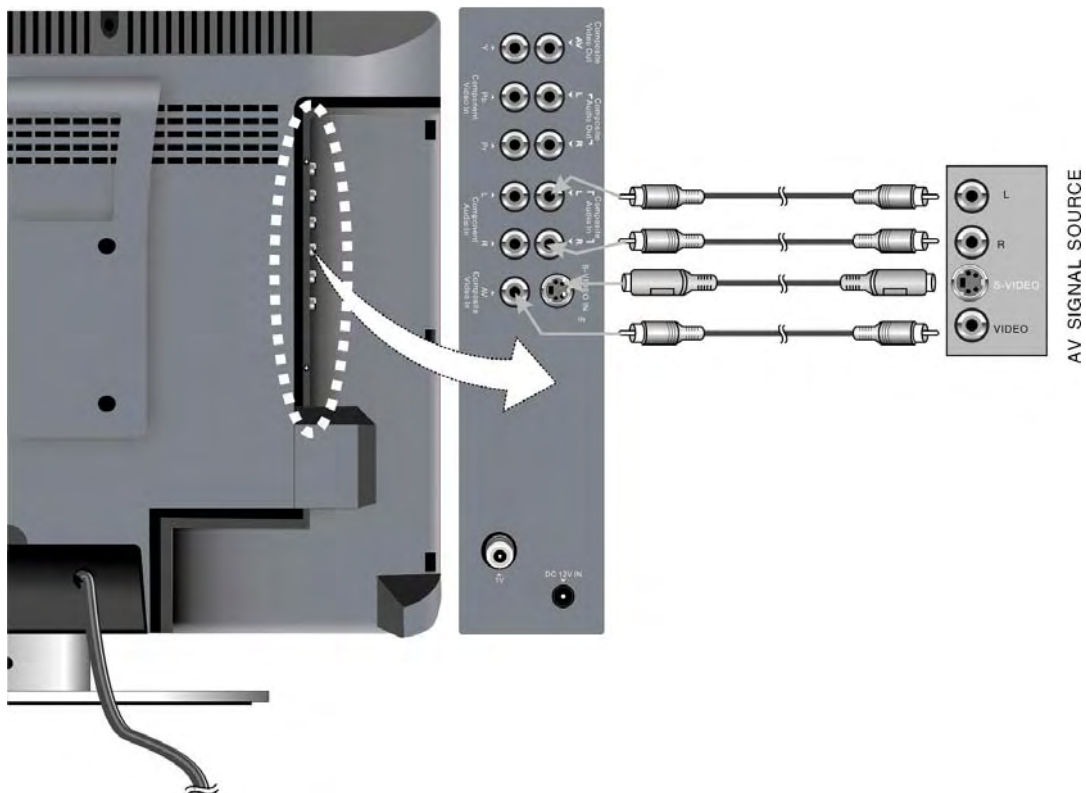

# System Connections (Continued)

## Connecting to External AV Signal Source (YPbPr)

Use the audio and video cables to connect the Y/Pb/Pr input Jacks on the rear panel of the unit to the external AV signal source.

After connection, turn on the power of the unit and external AV signal source and then press the SOURCE of the remote or the unit and select Component as the input mode..

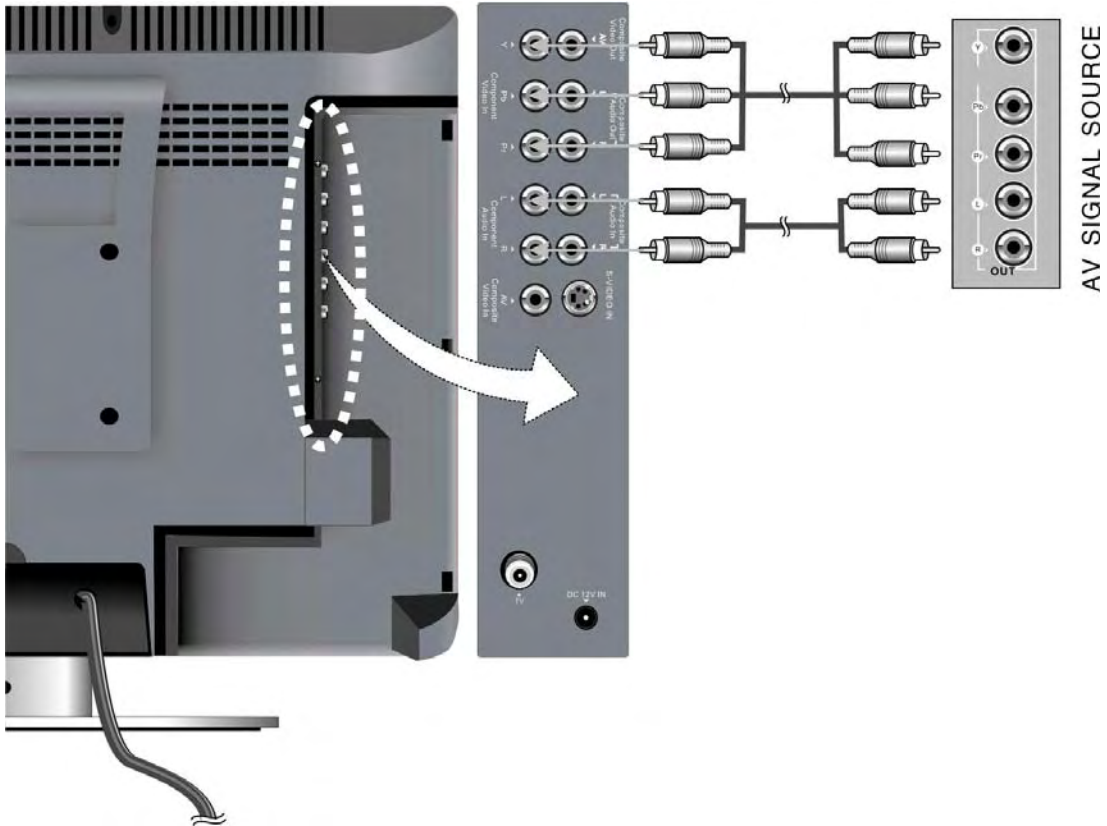



# System Connections (Continued)

## Connecting to External AV Device (AV Out)

The unit supports AV signal output, it can be connected to the external audio and video devices. Use the audio and video cables to connect the AV output jacks on the rear panel of the unit to the external AV device.

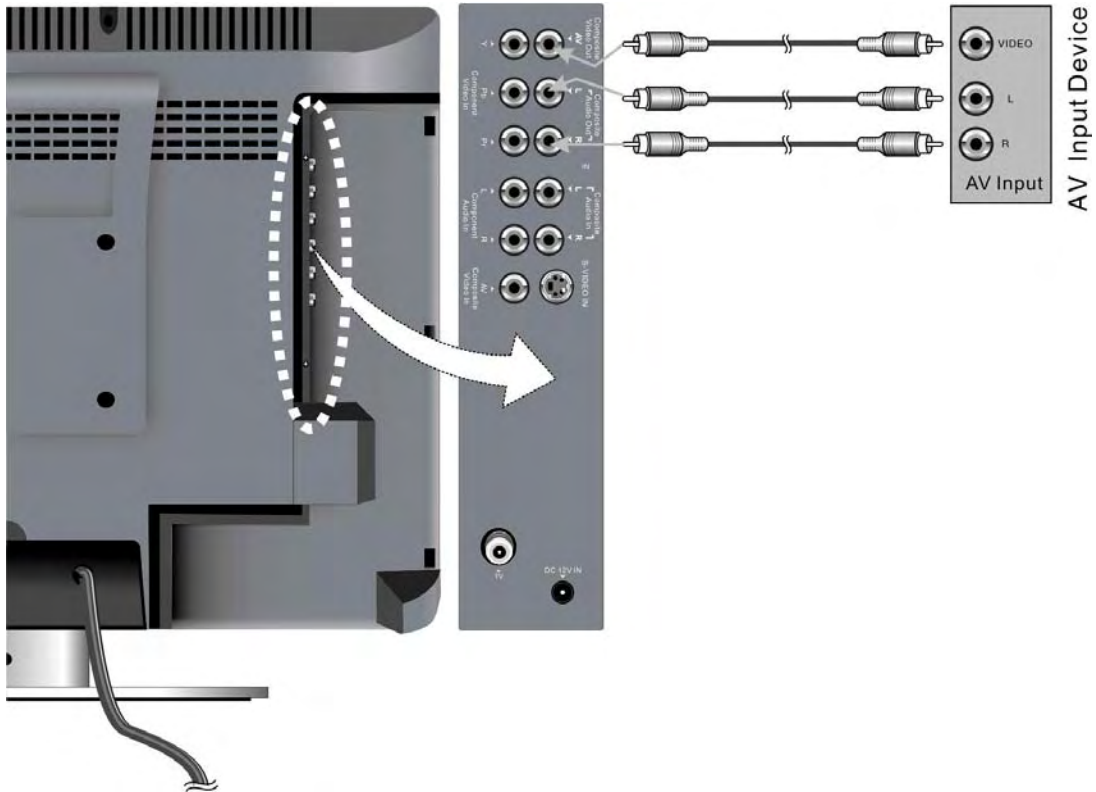

# System Connections (Continued)

## Connecting to PC

The unit can be connected to PC (personal computer) via the VGA cable. Follow these steps and the figure below to connect:

1. Connect one end of the VGA cable to the VGA input jack on the rear panel of the unit.
2. Connect the other end to the PC.
3. Connect one end of the audio cable to the PC audio input jack on the rear panel of the unit.
4. Connect the other end to the PC audio output jack.
5. Please set the PC's resolution at 1024x768@60Hz

After connection, turn on the unit and the PC and then press the SOURCE button of the remote or the unit and select VGA as the input mode.

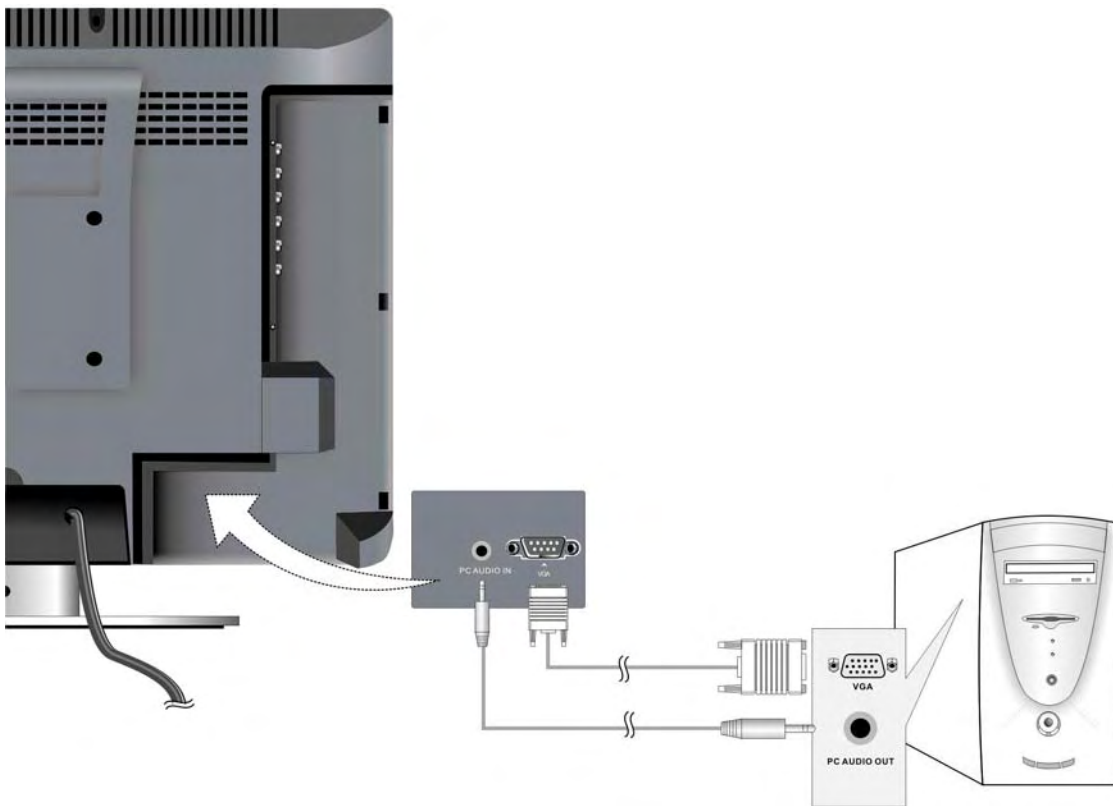



# System Connections (Continued)

## Connecting to Earphones

This unit can be connected to an earphone for listening music privately. See the below figure for details:



After connecting to the earphone, the internal speakers will turn off automatically.

## Connecting to Power Supply

Plug the power supply cord to the AC100~240V wall outlet.

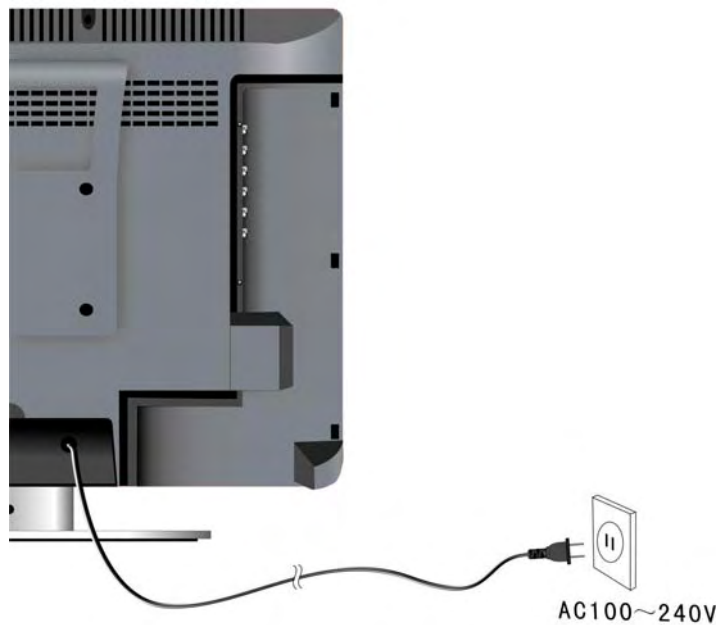

# System Connections (Continued)

## Connecting to Car Adapter

Power also can be supplied through the DC power adapter (Car Adapter), one end is connected to the DC 12V IN jack on the rear panel of the unit, the other end to the vehicle's 12V accessory/cigarette lighter/power outlet, as shown on the below:

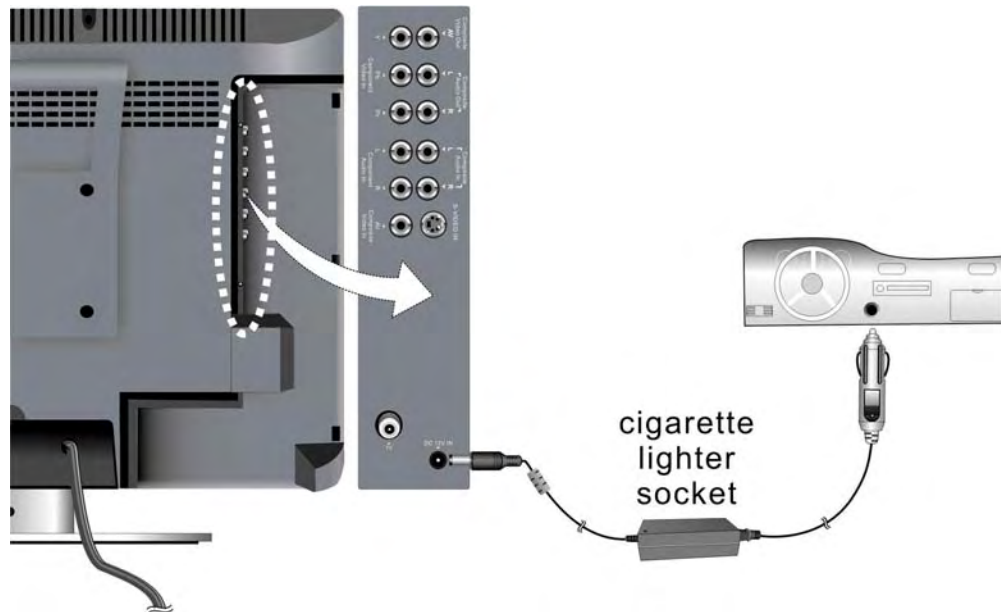

### Attention

- Do not operate the unit or view video software while driving a vehicle.
- Place the unit in a proper position for viewing.
- Do not connect the unit to the power outlet of the car until the car is running.

# System Connections (Continued)

## Connecting to TV Antenna

This unit can be connected to the TV signal input source via the TV jack on the rear panel.

After connection, turn on the power of the unit, press the SOURCE button of the remote or the unit and select TV as the input mode.

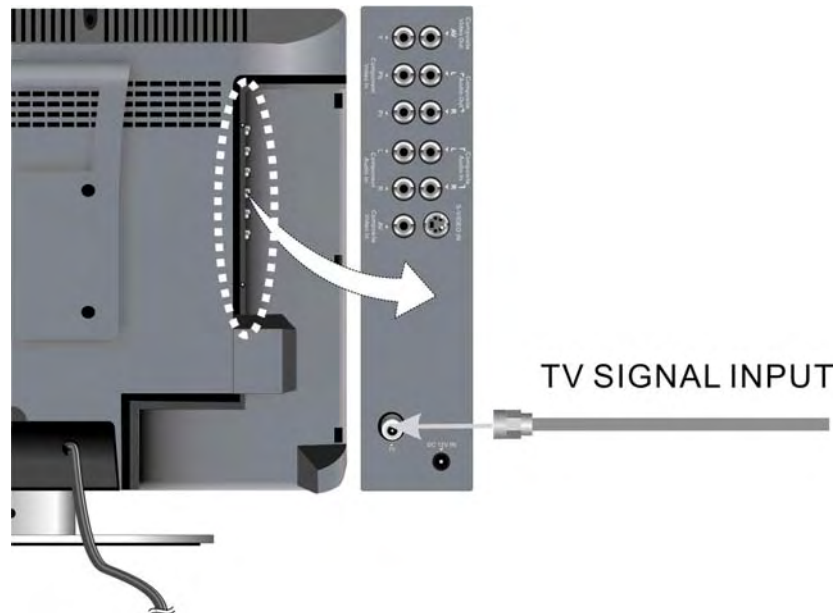

After connecting to the antenna, you can turn on the unit. To program search and select channels, do the following steps:

1. For channels 0 through 9:
  - Press the number buttons to select the channel X, wait three seconds and it will go to the selected channel.
  - Press the number button to select channel X, then press the  $\leftarrow$ / $\rightarrow$ +10 to go to the selected channel immediately.
  - Press the number buttons to input 00X, it will go to the selected channel immediately.
2. For channels 10 through 99:
  - Press the number buttons to select channel XX, wait three seconds and it will go to the selected channel.
  - Press the number buttons to select channel XX, then press the  $\leftarrow$ / $\rightarrow$ +10 button to enter the selected channel.
  - Or press the number buttons to input 0XX, it will go to the selected channel immediately.
3. For channels 100 through 100~199:
  - Press the number buttons to select channels XXX, and it will go to the selected channel.

NOTE: \* X is the channel number.

# TV Setup and Operation

## Preparations

1. After making your connections, press the POWER button to turn on the power. (If it is turned on, the power indicator is blue.)
2. Press the SOURCE button to shift to TV mode. You can go on with the following operations:

## Image Setting

**Note:** This item is only available when there is signal input.

Press the MENU button once to enter the setup menu, as shown on the right:

In the setup menu, press the ▲▼ button to select **Image** and then press the ENTER button to enter the item. Press the ▲▼ button to select. Press the MENU button to return to the previous menu.

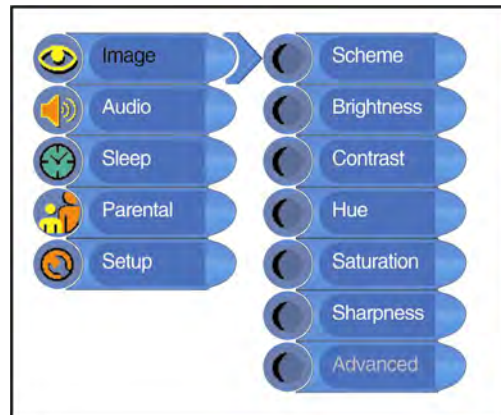

### Scheme Setup

Press the ▲▼ button to select **Scheme** and press the ENTER button to enter. Press the ▲▼ button to select the desired item and press the ENTER button to confirm your selection. Press the MENU button to return to the previous menu.

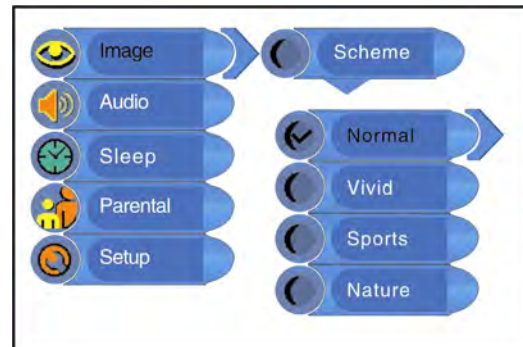

### Brightness Setup

Press the ▲▼ button to select **Brightness** and press the ◀▶ button to adjust the value. Press the MENU button to return to the previous menu.

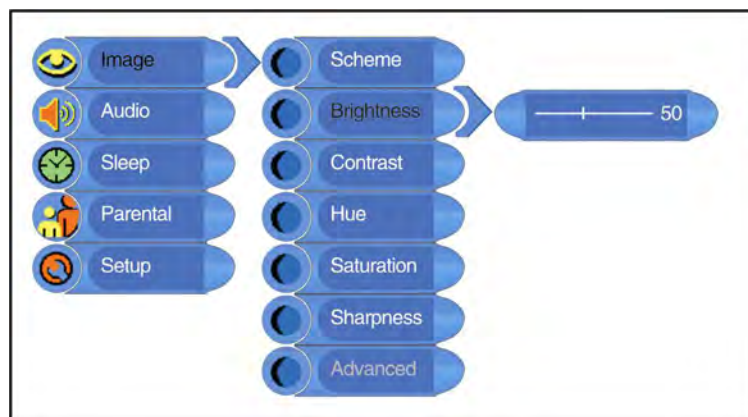

# TV Setup and Operation (Continued)

## **Contrast Setup**

Press the ▲▼ button to select **Contrast** and press the ◀▶ button to adjust the value. Press the MENU button to return to the previous menu.

## **Hue Setup**

Press the ▲▼ button to select **Hue** and press the ◀▶ button to adjust the value. Press the MENU button to return to the previous menu.

## **Saturation Setup**

Press the ▲▼ button to select **Saturation** and press the ◀▶ button to adjust the value. Press the MENU button to return to the previous menu.

## **Sharpness Setup**

Press the ▲▼ button to select **Sharpness** and press the ◀▶ button to adjust the value. Press the MENU button to return to the previous menu.

## **Advanced Setup**

Press the ▲▼ button to select **Advanced** and press the ENTER button to enter.

In the menu, press the ▲▼ button to select the desired item and then press the ENTER button to confirm. Press the MENU button to return to the previous menu.

**Note: This item is only available in Component, DVD and VGA modes.**

## **Audio Setting**

Press the MENU button once to enter the setup menu. Press the ▲▼ button to select **Audio** and press the ENTER button to enter the menu shown on the right.

In the **Audio** setup menu, press the ▲▼ button to select the desired item and press the ENTER button to enter. Press the MENU button to return to the previous menu.

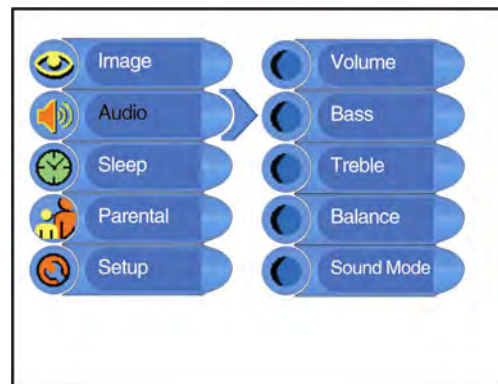

## **Volume Setup**

Press the ▲▼ button to select **Volume** and press the ◀▶ button to adjust the level. Press the MENU button to return to the previous menu.

## **Bass Setup**

Press the ▲▼ button to select **Bass** and press the ◀▶ button to adjust the level. Press the MENU button to return to the previous menu.

# TV Setup and Operation (Continued)

## Treble Setup

Press the ▲▼ button to select **Treble** and press the ◀▶ button to adjust the level. Press the MENU button to return to the previous menu.

## Balance Setup

Press the ▲▼ button to select **Balance** and press the ◀▶ button to adjust the level. Press the MENU button to return to the previous menu.

## Sound Mode Setup

Press the ▲▼ button to select **Sound Mode** and press the ENTER button to enter. Press the ▲▼ button to select the desired item and then press the ENTER button to confirm your selection. Press the MENU button to return to the previous menu.

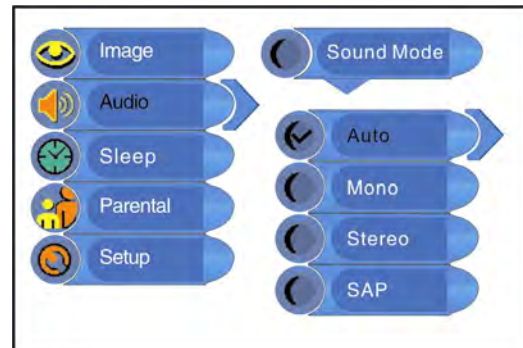

## Sleep Setting

Press the MENU button to enter the setup menu. Press the ▲▼ button to select **Sleep** and press the ENTER button to enter the menu shown on the right.

In the **Sleep** setup menu, press the ▲▼ button to select 15Min, 30Min, 45Min, 60Min, 75Min, 90Min, 105Min, 120Min or Off. Press the MENU button to return to the previous menu

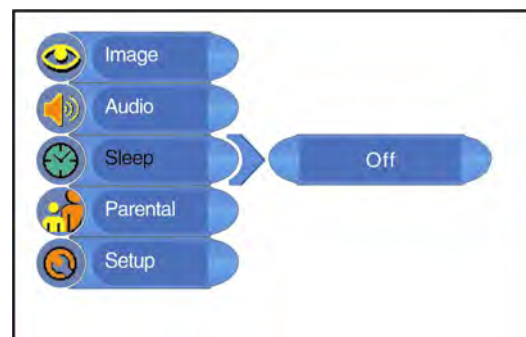



# TV Setup and Operation (Continued)

## Parental Setting

**Note:** The Parental Function is the same as that of V-CHIP.

Press the MENU button to enter the setup menu. Press the ▲▼ button to select **Parental** and press the ENTER button to enter the menu shown on the right.

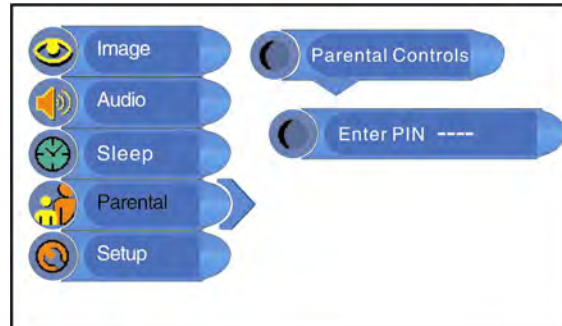

In the **Parental** setup menu, press the ENTER button and then use the number buttons to enter the pin. The initial pin is 1111. Then press the ENTER button to continue and display the menu as shown on the right.

**Note:** The Master password is 3308. This password is always effective even after you have selected your own password and changed it.

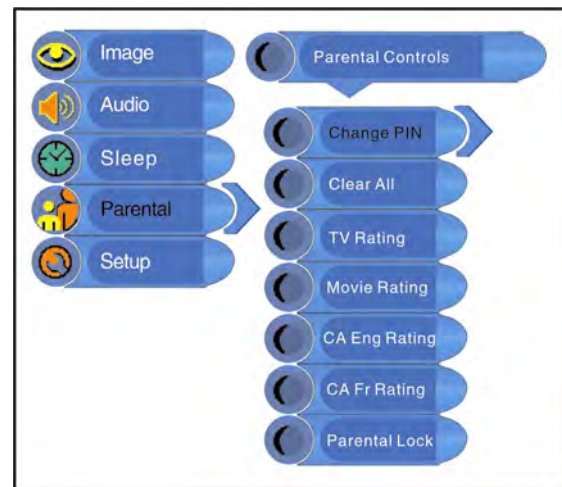

### **Change PIN**

Press the ▲▼ button to select **Change PIN** and press the ENTER button to enter. Use the number buttons to enter the new pin you want and then press the ENTER button to confirm. Then use the number buttons to enter the new pin again and press the ENTER button to confirm and return to the previous menu.

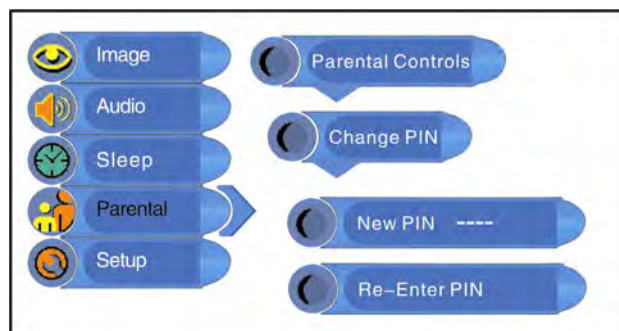

# TV Setup and Operation (Continued)

## Clear All

Press the ▲▼ button to select **Clear All** and press the ENTER button to enter. Press the ▲▼ button to select the desired item and then press the ENTER button to confirm your selection. Press the MENU button to return to the previous menu.

## TV Rating

Press the ▲▼ button to select **TV Rating** and press the ENTER button to enter. Press the ▲▼ button to select the desired item and then press the ENTER button to confirm your selection. Press the MENU button to return to the previous menu.

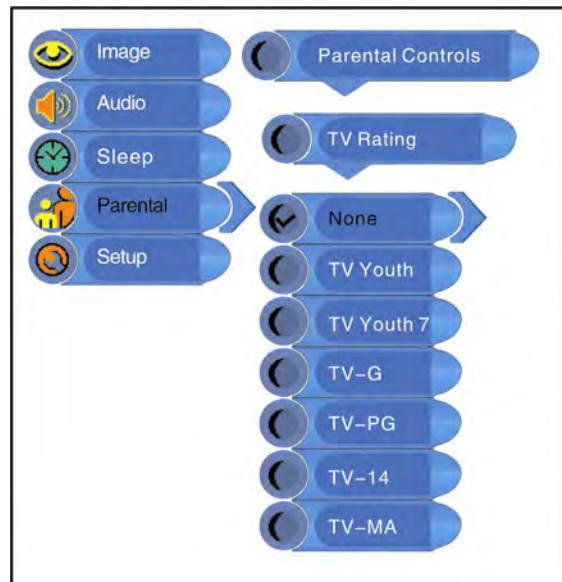

## Movie Rating

Press the ▲▼ button to select **Movie Rating** and press the ENTER button to enter. Press the ▲▼ button to select the desired item and then press the ENTER button to confirm your selection. Press the MENU button to return to the previous menu.

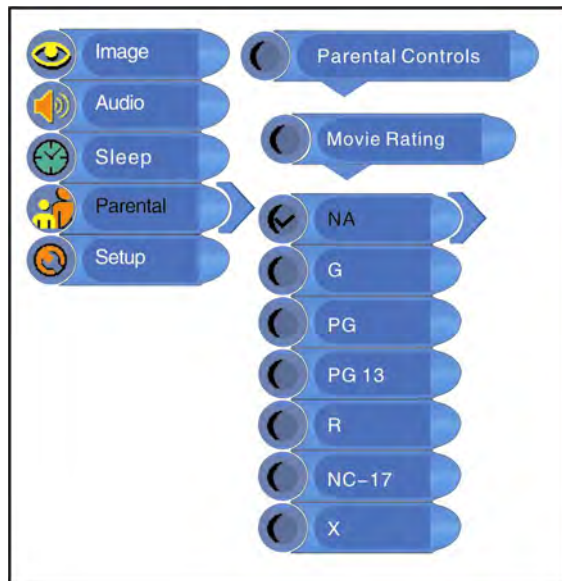



# TV Setup and Operation (Continued)

## CA Eng Rating

Press the ▲▼ button to select **CA Eng Rating** and press the ENTER button to enter. Press the ▲▼ button to select the desired item and then press the ENTER button to confirm your selection. Press the MENU button to return to the previous menu.

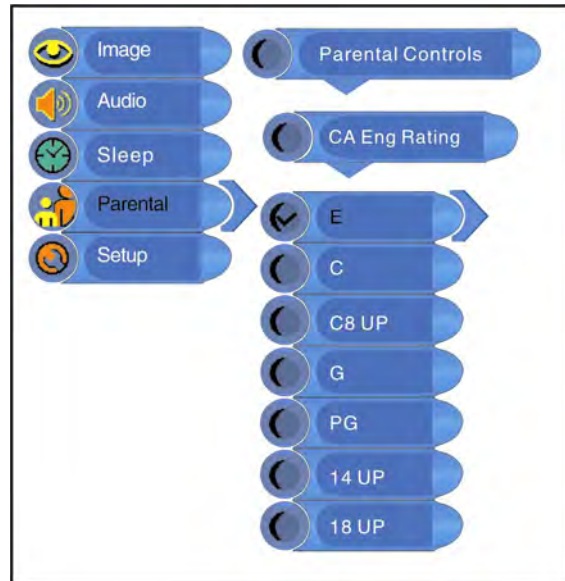

## CA Fr Rating

Press the ▲▼ button to select **CA Fr Rating** and press the ENTER button to enter. Press the ▲▼ button to select the desired item and then press the ENTER button to confirm your selection. Press the MENU button to return to the previous menu.

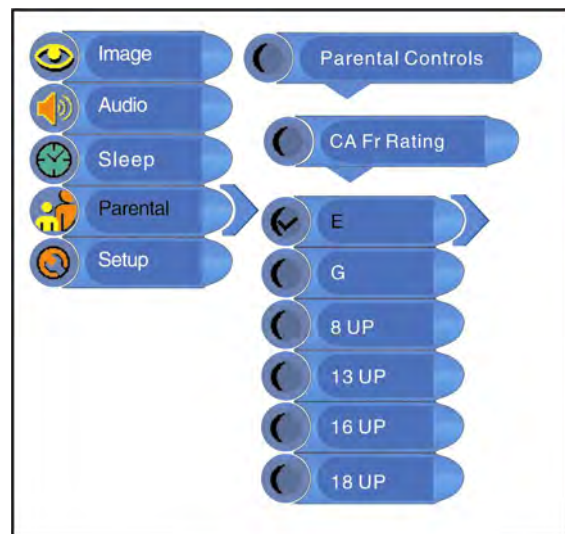

## Parental Lock

Press the ▲▼ button to select **Parental Lock** and press the ENTER button to enter. Press the ▲▼ button to select the desired item and then press the ENTER button to confirm your selection. Press the MENU button to return to the previous menu.

# TV Setup and Operation (Continued)

## Setup Setting

Press the MENU button once to enter the setup menu. Press the ▲▼ button to select **Setup** and press the ENTER button to enter the menu shown on the right.

In the **Setup** menu, press the ▲▼ button to select the desired item and press the ENTER button to enter. Press the MENU button to return to the previous menu.

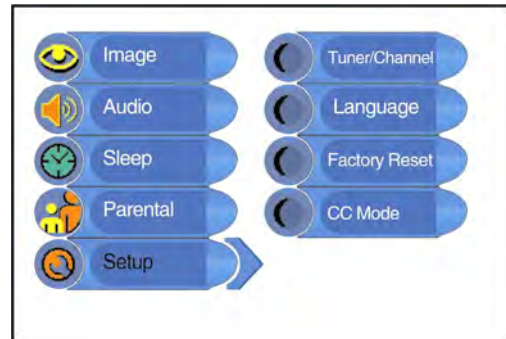

## **Tuner/Channel**

Press the ▲▼ button to select the **Tuner/Channel** and press the ENTER button to enter the menu as shown on the right. Press the ▲▼ button to select the desired item and press the ENTER button to enter. Press the MENU button to return to the previous menu.

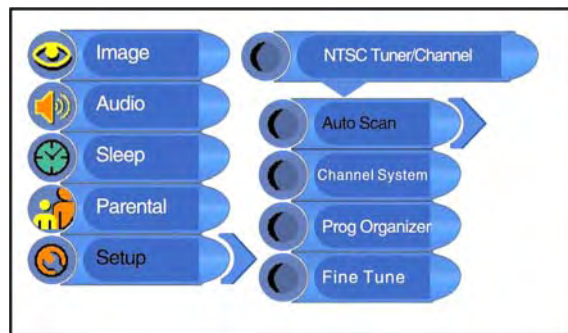

## **Auto Scan**

Press the ▲▼ button to select the **Auto Scan**, press the ENTER button to start auto scan. The screen will display as below:

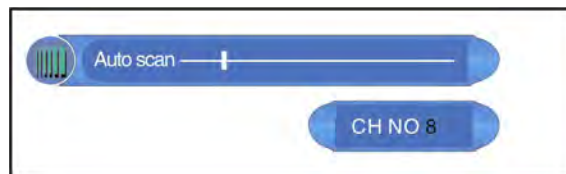

Auto scan will take a few minutes, when the tuning operation completes the unit will exit and memorize the programs by sequence automatically. During tuning, press the MENU button to exit the auto scan mode.

# TV Setup and Operation (Continued)

## Channel System

Press the ▲▼ button to select **Channel System** and press the ENTER button to enter. Press the ▲▼ button to select the desired item and then press the ENTER button to confirm your selection. Press the MENU button to return to the previous menu.

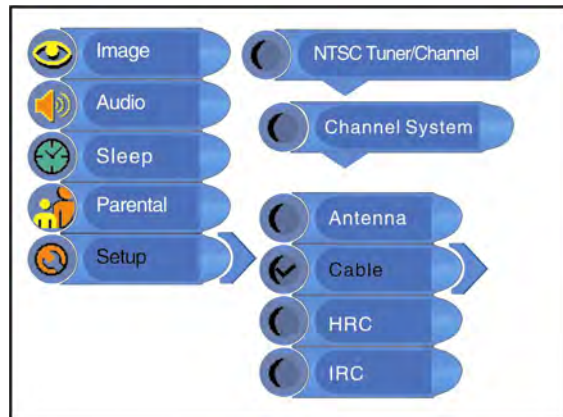

## Prog Organizer

Press the ▲▼ button to select the **Prog Organizer** and press the ENTER button to enter the menu as shown on the right.

In the **Prog Organizer** setup menu, press the ▲▼ button to select the desired item. Press the MENU button to return to the previous menu.

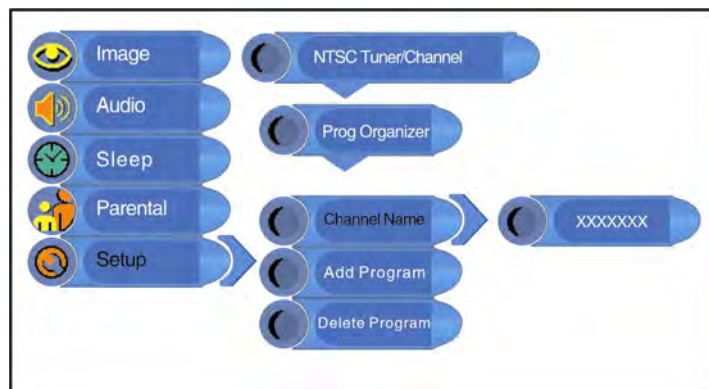

## Channel Name

Press the ▲▼ button to select the **Channel Name** and press the ENTER button to enter. Then press the ▲▼ button to select letters or press the number button to input numbers. Press the MENU button to return to the previous menu.

## Add Program

Press the ▲▼ button to select the **Add Program** and press the ENTER button to activate the skip function which when using the CH ▲▼ button to select channels under normal playback status, it will skip the current channel. Press the MENU button to return to the previous menu.

## Delete Program

Press the ▲▼ button to select the **Delete Program** and press the ENTER button to cancel the skip function which when using the CH ▲▼ button to select channels under normal playback status, it will play the channels in sequence. Press the MENU button to return to the previous menu.

# TV Setup and Operation (Continued)

## Fine Tune

Press the ▲▼ button to select **Fine Tune** and press the ENTER button to enter. Press the ► or ◀ button to start fine tuning forward or backward. Press the MENU button to return to the previous menu.

## Language

Press the ▲▼ button to select the **Language**, press the ENTER button to enter the setup, press the ▲▼ button to select item. Press the MENU button to return to the previous menu.

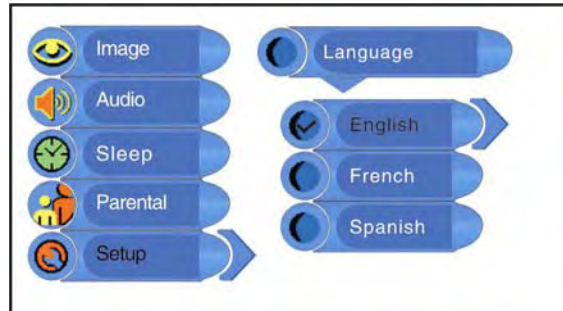

## Factory Reset

Press the ▲▼ button to select the **Factory Reset**, press the ENTER button to resume default status.

## CC Mode

Press the ▲▼ button to select **CC Mode** and press the ENTER button to enter. Press the ▲▼ button to select the desired item and then press the ENTER button to confirm your selection. Press the MENU button to return to the previous menu.

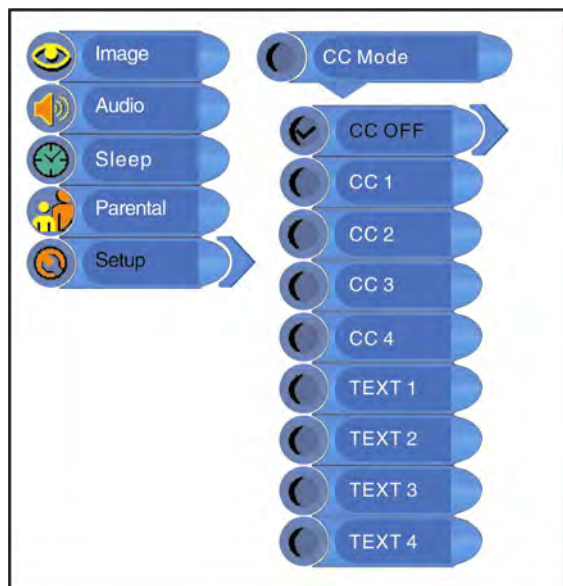

# DVD System Setup

## Preparations

1. Connect to the power supply and turn on the unit.
2. Press the SOURCE button to select the DVD mode.
3. Press the SETUP button on the remote control to display the settings menu. The menu includes General setup, Audio setup, Video setup, and Preference.
4. Press the ◀ ▶ direction buttons on the remote control to select a category. All the items in the category will appear on the screen.
5. Press the SETUP button again to exit the setup.

## General Setup Page

Press the SETUP button to enter the General setup menu. The screen will display as the following:

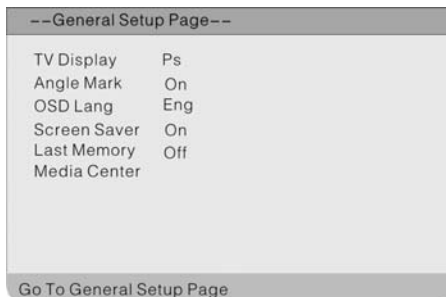

In the menu, Use the ▲ ▼ direction buttons to select the desired item. Press the ENTER button to enter the item. Press the ◀ button to return.

## TV Display

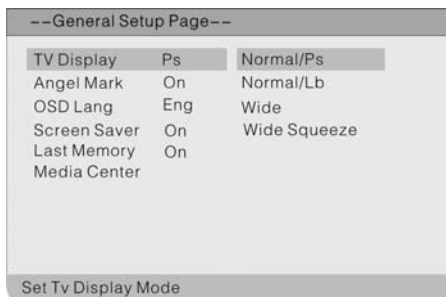

1. Press the ▲ ▼ direction buttons to select **TV Display**.
2. Press the ENTER button to enter the setup.
3. Use the ▲ ▼ direction buttons to select items.
4. Press the ENTER button again to confirm selection and return.

## Angle Mark

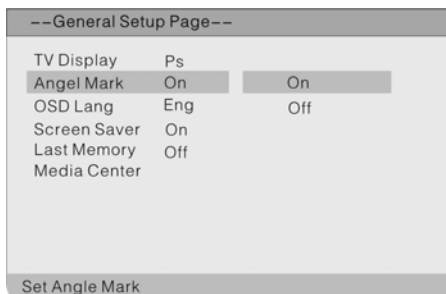

1. Press the ▲ ▼ direction buttons to select **Angle Mark**.
2. Press the ENTER button to enter the setup.
3. Use the ▲ ▼ direction buttons to select On or Off.
4. Press the ENTER button again to confirm selection and return.

# DVD System Setup (Continued)

## OSD Lang

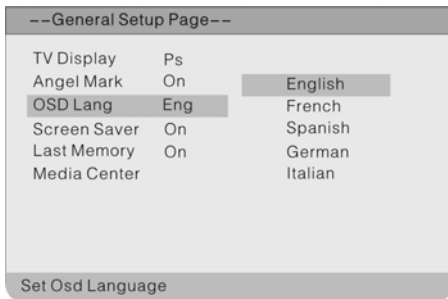

The item is used to select the OSD language.

1. Press the ▲ ▼ direction buttons to select **OSD Lang**.
2. Press the ENTER button to enter the setup.
3. Use the ▲ ▼ direction buttons to select items.
4. Press the ENTER button again to confirm selection and return.

## Screen Saver

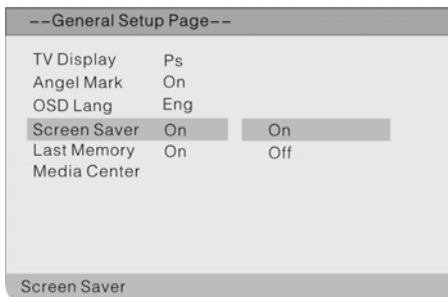

1. Press the ▲ ▼ direction buttons to select **Screen Saver**.
2. Press the ENTER button to enter the setup.
3. Use the ▲ ▼ direction buttons to select On or Off.
4. Press the ENTER button again to confirm selection and to return.

## Last Memory

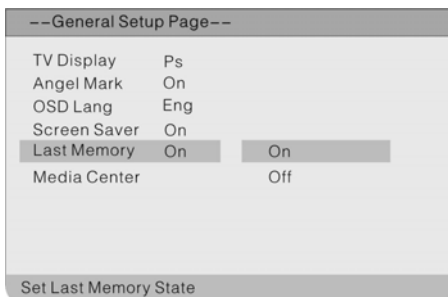

1. Press the ▲ ▼ direction buttons to select **Last Memory**.
2. Press the ENTER button to enter the setup.
3. Use the ▲ ▼ direction buttons to select On or Off.
4. Press the ENTER button again to confirm selection and return.

## Media Center

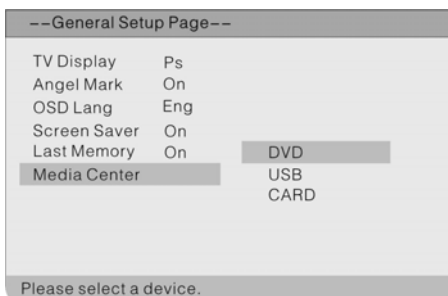

1. Press the ▲ ▼ direction buttons to select **Media Center**.
2. Press the ENTER button to enter the setup.
3. Use the ▲ ▼ direction buttons to select DVD, USB or CARD.
4. Press the ENTER button again to confirm selection and return.

# DVD System Setup (Continued)

## Audio Setup Page

Press the SETUP button to enter the General setup menu, then use the ◀ ▶ direction buttons to select Audio Setup Page, the screen will display as the following:

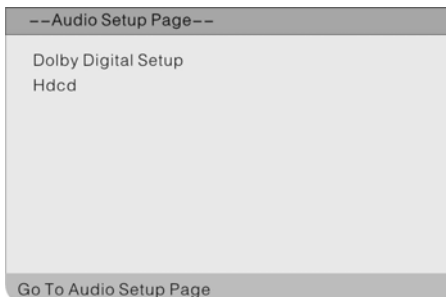

In the menu, Use the ▲ ▼ direction buttons to select the desired item. Press the ENTER button to enter the item. Press the ◀ button to return.

## Dolby Digital Setup

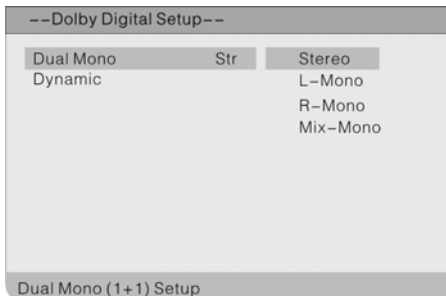

1. Press the ▲ ▼ direction buttons to select **Dolby Digital**.
2. Press the ENTER button to enter the setup, the screen will display as left:
3. In the menu, use the ▲ ▼ direction buttons to select items.
4. Press the ENTER button to enter the setup. Press the ◀ button to return.

## Dual Mono

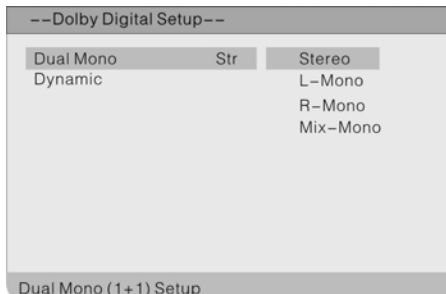

1. Press the ▲ ▼ direction buttons to select **Dual Mono**.
2. Press the ENTER button to enter the setup.
3. Use the ▲ ▼ direction buttons to select items.
4. Press the ENTER button again to confirm selection and return.

## Dynamic

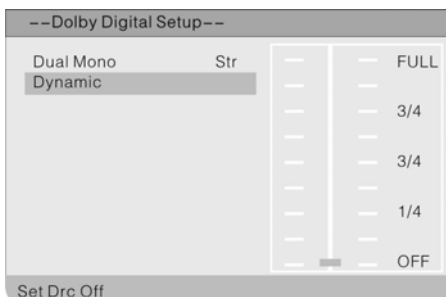

1. Press the ▲ ▼ direction buttons to select **Dynamic**.
2. Press the ENTER button to enter the setup, the screen will display as left:
3. Press the ENTER button to enter.
4. Use the ▲ ▼ direction buttons to adjust.
5. Press the ENTER button again to confirm setting and return.
6. Press the ◀ button to return.

# DVD System Setup (Continued)

## Hdcd Setup

In the Audio Setup Page, use the ▲ ▼ direction buttons to select **Hdcd Setup**, press the ENTER button to enter the setup, the screen will display as below:

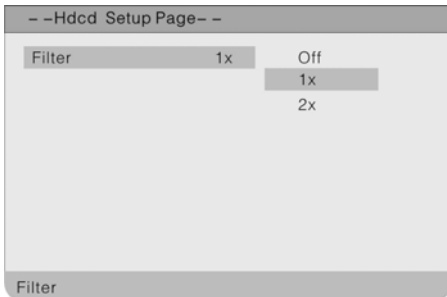

1. In the menu, press the ENTER button to enter the setup.
2. Use the ▲ ▼ direction buttons to select items.
3. Press the ENTER button again to confirm selection and return.
4. Press the ◀ button to return.

## Video Setup

Press the SETUP button to enter the General setup menu, then use the ◀ ▶ direction buttons to select Video Setup Page, the screen will display as the following:

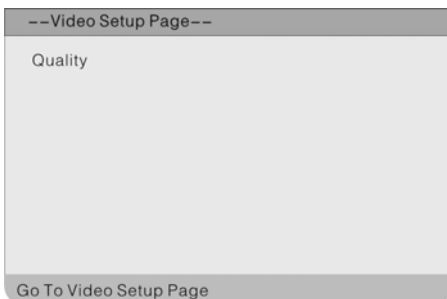

In the menu, Use the ▲ ▼ direction buttons to select the desired item. Press the ENTER button to enter the item. Press the ◀ button to return.

## Video Quality Setup

Select **Quality**, press the ENTER button to enter the menu as below:



1. In the menu, Use the ▲ ▼ direction buttons to select the desired item.
2. Press the ENTER button to enter the item.
3. Press the ◀ button to return.



# DVD System Setup (Continued)

## Sharpness



1. Press the ▲▼ direction buttons to select **Sharpness**.
2. Press the ENTER button to enter the setup.
3. Use the ▲▼ direction buttons to select High, Medium or Low.
4. Press the ENTER button again to confirm selection and return.

## Brightness



1. Press the ▲▼ direction buttons to select **Sharpness**.
2. Press the ENTER button to enter the setup, the screen will display as left:
3. Use the ◀▶ direction buttons to adjust the level.
4. Press the ENTER button again to confirm setting and return.

## Contrast



1. Press the ▲▼ direction buttons to select **Contrast**.
2. Press the ENTER button to enter the setup, the screen will display as left:
3. Use the ◀▶ direction buttons to adjust the level.
4. Press the ENTER button again to confirm setting and return.

## Preference Setup

Press the SETUP button to enter the General setup menu, then use the ◀▶ direction buttons to select Preference Page, the screen will display as the following:

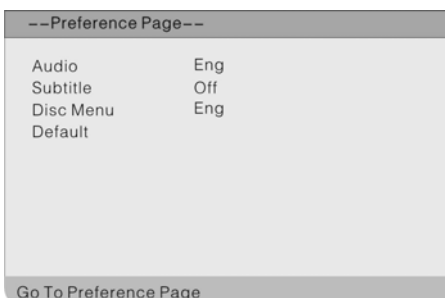

In the menu, Use the ▲▼ direction buttons to select the desired item. Press the ENTER button to enter the item. Press the ◀ button to return.

# DVD System Setup (Continued)

## Audio



1. Press the ▲ ▼ direction buttons to select **Audio**.
2. Press the ENTER button to enter the setup, see the left figure:
3. Press the ▲ ▼ direction buttons to select audio language.
4. Press the ENTER button again to confirm setting and return.

## Subtitle



1. Press the ▲ ▼ direction buttons to select **Subtitle**.
2. Press the ENTER button to enter the setup, see the left figure:
3. Press the ▲ ▼ direction buttons to select Subtitle language.
4. Press the ENTER button again to confirm setting and return.

## Disc Menu

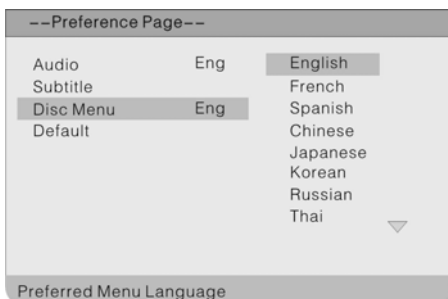

1. Press the ▲ ▼ direction buttons to select **Disc Menu**.
2. Press the ENTER button to enter the setup, see the left figure:
3. Press the ▲ ▼ direction buttons to select Menu language.
4. Press the ENTER button again to confirm setting and return.

## Default

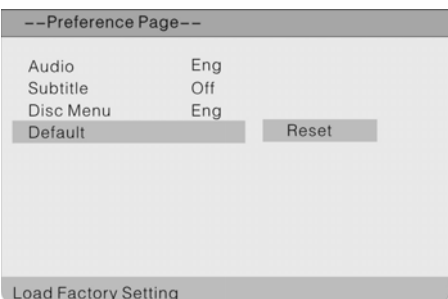

1. Press the ▲ ▼ direction buttons to select **Default**.
2. Press the ENTER button, all the settings will return to the default status.

# DVD Playback Operation

**Preparation:** After making all your connections turn on the unit and select the relevant video input before playback.

## **Disc Loading Steps:**

1. Press the POWER button to turn on the power. Press the SOURCE button to shift to DVD mode.
2. Please handle the disc with its printed side outward vertically to the disc tray. (Referring to the below picture.)
3. Slightly put the disc into the disc tray.
4. As disc is automatically taken in the disc tray fully, the player will search a disc and play it automatically in DVD mode.



**Warning:** Do not play poor quality discs as this may damage the player.

## **DVD Playback**

### **Region Code**

DVD players and discs are coded by region. These regional codes must match the played discs. If the codes don't match, the disc cannot be played. This player's default code is region 1.

### **Play**

Press the PLAY button to start playback. Press the STOP button once on the remote control to stop playback, and press the PLAY button again to resume playback.

# DVD Playback Operation (Continued)

## **Stop**

Press the ■ STOP button once to stop playback and then press PLAY button to resume. Press this button twice to stop playback completely.

## **Pause**

Press the PAUSE button once to pause the playback, press it repeatedly to start frame-by-frame playback, press the ► PLAY button to resume normal playback.

## **Previous ◀◀ and Next ▶▶**

Press the ▶▶ button to go to the next chapter or track. Press the ◀◀ button once to return to the beginning of the current chapter or track, press it twice to go to the previous chapter or track.

## **Fast Playback**

Press the ◀◀ or ▶▶ FWD/REV SCAN button on the remote control to activate fast backward or forward playback.

## **SLOW**

During DVD disc playback, press the SLOW button on the remote control to start slow playback. During slow playback, press the PLAY button to resume normal playback.

## **Repeat**

Use the REPEAT button repeatedly to repeat a chapter, title or all.

◆ Some discs do not support the repeat function.

## **A-B Repeat**

During DVD disc playback, press the A-B button to select the segment that you want to play repeatedly.

Press the A-B button first time once to set the beginning point "A", press the A-B button again to set the ending point "B" and it will play the segment repeatedly. Press the A-B button third time to cancel the repeat segment.

## **Menu**

Normally there is a selecting menu for DVD discs. You can press the red MENU button to enter the menu, and use the direction buttons to highlight an item. Press the ENTER button to confirm.

## **Title & Chapter**

Normally there are several titles in a DVD disc, and several chapters (sections) in a title. You can select any title or chapter quickly by entering the relevant number.

## **Zoom in or out**

During DVD disc playback, press the ZOOM button to display the image as 2X—3X—4X—1/2—1/3—1/4—normal size in sequence. When zooming in the picture, you can use the direction buttons to move the picture.

# DVD Playback Operation (Continued)

## **Language (Audio)**

There can be up to 8 audio languages on a DVD disc. When you play a multi-language DVD disc you can press the AUDIO button on the remote control to select a language.

## **Subtitle**

The DVD player can support multiple kinds of subtitles. When you play a multi-subtitle disc you can press the SUBTITLE button on the remote control to select different subtitles.

## **GOTO**

During DVD disc playback, press the GOTO button on the remote control once, there will be a menu displayed on the screen. You can set or select items for your preference. Use the ▲ ▼ direction buttons to select items, press the ENTER button to enter and use the ▲ ▼ direction buttons to select the desired item. Press the ◀ direction button to return. When select the Title/Chapter, TT Time/CH Time, use number buttons to input desired title/chapter number time.

◆ Some DVD discs do not support the search function.

## **Various Camera Angles**

The movies on some DVDs have been recorded from various camera positions. This lets you enjoy the same scene from different perspectives. In this case you'll usually find a marking on the DVD sleeve.

When playing a DVD containing various camera angles the camera symbol appears on the screen. Press the ANGLE button repeatedly until the desired perspective is shown. The picture will be adjusted in 1~2 seconds.

## **CD Playback**

The player will play all tracks on a CD disc by default. You can use the ◀◀ and ▶▶ (PREV/NEXT skip) buttons, or number buttons to select a track.

## **Stop**

Press the ■ STOP button once to stop playback and then press PLAY button to resume. Press this button twice to stop playback completely.

## **Pause**

Press the PAUSE button to pause the playback. Then press the PAUSE button again or ▶ PLAY button to resume normal playback.

## **Previous and Next**

Press the ◀◀ button once to go the beginning of this track. Press twice repeatedly to go the previous track.

Press the ▶▶ button to play from the beginning of the next track.

# DVD Playback Operation (Continued)

## **Fast Playback**

Press the ◀ or ▶ FWD/REV SCAN button on the remote control to activate fast backward or forward playback.

## **Repeat**

Use the REPEAT button repeatedly to repeat Track, All or to cancel repeat.

- ◆ Some discs do not support the repeat function.

## **Audio**

During CD playback, press the AUDIO button on the remote control to select the audio output mode: Mono Left, Mono Right, Mix-Mono and Stereo.

## **GOTO**

Press the GOTO button to access the time-selected state. You can select Disc Go To, Track Go To or Select Track respectively by pressing this button repeatedly. Use the 0-9 buttons to enter the desired time, and then the player will play according to the selected time.

## **JPEG Playback**

JPEG is a common picture format that requires small amounts of storage per image and has low loss in resolution. Hundreds of pictures can be stored on a disc in this format. In order to view JPEG photo albums, you can ask your film development company to make a "PICTURE CD" when they develop your film.

## **Normal Playback**

Load a JPEG disc in. For JPEG disc, there will be a root menu displayed on the screen. Use the ENTER button and the direction button to select a submenu, and then use the ▲▼ direction button to select the contents. Many discs have other contents besides pictures.

For Picture CD disc, it will display the pictures automatically.

During playback, press the ◀ or ▶ button to select picture.

- ◆ **Many discs have other contents besides pictures.**

## **Stop**

Press the ■ STOP button once to stop playback and return to the preview menu. Press the ▶ PLAY button to resume normal playback.

## **Pause**

Press the PAUSE button to pause playback. Press the PAUSE button again or ▶ PLAY button to resume normal playback.

## **Repeat**

During playback, press the REPEAT button repeatedly, and the repeat modes are Shuffle, Random, Single, Repeat One, Repeat All and Repeat Off.

# **DVD Playback Operation (Continued)**

## **Previous and Next**

During playback, press the ◀◀ or ▶▶ button to select picture.

## **Menu**

Press the MENU button once to stop playback and return to the root menu.

## **GOTO**

During playback, press the GOTO button on the remote control once, use the number buttons to input the file number.

## **Picture Rotation**

This can be used only when the picture is normally displayed. Once another picture is selected, rotation will be cancelled automatically. Use the ◀ ▶ buttons to rotate the picture.

## **Zoom and Move of Picture**

During playback, press the ZOOM button to activate the zoom function, press the ◀◀/▶▶ button to cycle through the zoom proportions. When zooming in the picture, you can use the direction buttons to move the picture.

◆ **Some JPEG disc may not support rotating function.**

# USB and SD/MS/MMC Card Function

## USB and SD/MS/MMC Card Function

### Preparation:

1. Connect the unit to the power supply.
2. Press the POWER to turn on the unit.
3. Press the SOURCE button to shift to DVD mode.
4. Insert the USB into the unit's USB slot, or insert the SD/MS/MMC card into the SD/MS/MMC card slot on the right side of the unit. Please see the below figure:



- Make sure that files are stored in the USB and the SD/MS/MMC card before the connection.
5. Press the CARD button to shift among disc playback, USB playback and the SD/MS/MMC playback. The default state is disk playback. Please see the below figure:

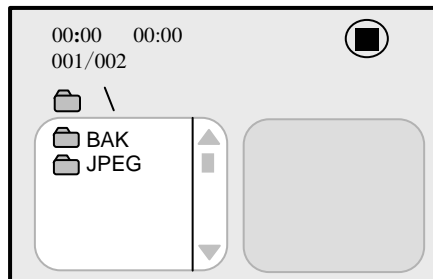

6. Press the ▲, ▼ button to select the folder, and press ENTER button to enter.
7. Press the ▲ and ▼ buttons to select the desired track. Then press PLAY ► button to start playback.
8. Press STOP ■ button to stop playback: if the STOP ■ button is pressed, the playback will start from the beginning of the current track. Press the ◀ button to return to the folder menu.

### Note:

1. The screen display will vary from disc to disc.
2. Pull out the USB or SD/MS/MMC card directly after the files are played. The unit will be in the state of disc playback again.



# Other Functions

---

## External AV Input Function

The unit has external AV input function. It supports COMPOSITE, S-VIDEO and Component modes. Use the audio, video and S-Video cable to connect the unit to the external AV signal source such as recorder, vidicon, satellite receiver or game player etc. Then turn on the unit and the external AV signal source. Press the SOURCE button to shift to the corresponding mode: S-VIDEO or Component. Then you can go on to set up the menu in a certain mode.

## Computer Screen Function

The TFT LCD screen of the unit can be used as the computer screen. Take the steps of connecting the unit to the PC and then you can set up the menu.

You had better set the PC's resolution at: 1024 x 768@60Hz.

**The operations of these menus in COMPOSITE, S-VIDEO, Component and VGA modes are the same with those in the TV mode. Please refer to the introduction in "TV Function".**

**Note: Some of these menus are not available in these modes.**

# Troubleshooting

SYMPTOM	CHECK ITEM
The player cannot play.	Make sure disc is loaded in. Make sure disc is loaded correctly. Make sure disc is not dirty or warped. Make sure the player's region code is the same as region code of DVD disc. Make sure water condensation has not occurred. If it occurs, take out disc and leave the player on for at least one hour.
There is no sound.	Make sure system connection is correct. Make sure the sound setup of DVD disc is correct. Make sure disc is not dirty or warped. Clean or replace the disc. Make sure the speakers are not muted. In the TV mode, set the correct sound mode.
LCD does not display an image or is blank.	Make sure the unit is turned on and the connections are correct. Make sure the power adapter is correctly connected.
Cannot continue to play and play a section repeatedly.	Make sure is not in A-B or other repeat status. Make sure disc is not dirty or damaged.
There is no picture or the picture moves up and down.	Check if the connections with the external AV signal source are correct. Correctly set the items in the picture menu. Check if the video type input signal is not corresponding to the unit. Make sure the unit is turned on and in correct video type.
The remote control does not work.	Make sure there are no obstructions between the remote control and the player. Make sure the remote control is pointing at the player. Make sure batteries are inserted and the polarity is correct. Make sure battery is not weak.

## Other Notes:

Static or other external interference may cause the player to behave abnormally. In this occurrence, unplug the power-supply cord from the outlet and plug it in again to reset the player. If the problems persist, then please disconnect the power and consult a qualified technician.

# Specifications

---

---

TFT-LCD Resolution	1024 x 768
TFT-LCD Screen Size	15 inches
Power	AC100~240V, 50/60Hz DC 12V 4A
Power Consumption	< 48W
Dimension	388mm x 176mm x 374mm (LXWXD)
Weight	About 5.8 Kg
Ambient Temperature	10~45°C

**DESIGN AND SPECIFICATIONS ARE SUBJECT TO CHANGE WITHOUT NOTICE**

Manufactured under license from Dolby Laboratories.  
“Dolby” and the double-D symbol are trademarks of Dolby Laboratories.  
Confidential unpublished works. ©1992 -1997 Dolby Laboratories, Inc.  
All rights reserved.

"Polaroid" and "Polaroid and Pixel" are trademarks of Polaroid Corporation, Waltham, MA, USA.

For service, support and warranty information, visit [www.polaroid.com](http://www.polaroid.com) or  
in the US call 1-866-289-5168 and in Canada call 1-866-301-7922.



## Free Manuals Download Website

<http://myh66.com>

<http://usermanuals.us>

<http://www.somanuals.com>

<http://www.4manuals.cc>

<http://www.manual-lib.com>

<http://www.404manual.com>

<http://www.luxmanual.com>

<http://aubethermostatmanual.com>

Golf course search by state

<http://golfingnear.com>

Email search by domain

<http://emailbydomain.com>

Auto manuals search

<http://auto.somanuals.com>

TV manuals search

<http://tv.somanuals.com>