



I-Sonic™

*The Complete Digital Entertainment System
Owner's Guide*

Safety Warning

Important Safety Instructions—Read Before Operating Equipment

This product was designed and manufactured to meet strict quality and safety standards. There are, however, some installation and operation precautions which you should be particularly aware of.

1. **Read Instructions.** All the safety and operating instructions should be read before the system is operated.
2. **Retain Instructions.** The safety and operating instructions should be retained for future reference.
3. **Heed Warnings.** All warnings on the appliances and in the operating instructions should be adhered to.
4. **Follow Instructions.** All operating and use instructions should be followed.
5. **Cleaning.** Unplug the appliance from wall outlet before cleaning. Do not use liquid cleaners or aerosol cleaners. Use a damp cloth for cleaning.
6. **Attachments.** Do not use attachments not recommended by the product manufacturer as they may cause hazards.
7. **Water and Moisture.** Do not use these appliances near water—for example, near a bath tub, wash bowl, kitchen sink, or laundry tub, in a wet basement, or near a swimming pool, and the like.
8. **Accessories.** Do not place these appliances on an unstable cart, stand, tripod, bracket, or table. The audio/video products may fall, causing serious injury to a child or adult, and serious damage to the products. Use only with a cart, stand, tripod, bracket, or table recommended by the manufacturer, or sold with the appliances. Any mounting of the appliances should follow the manufacturer's instructions, and should use mounting accessories recommended by the manufacturer.
9. **Ventilation.** Slots and openings in the cabinet are provided for ventilation and to ensure reliable operation of the appliances and to protect them from overheating, and these openings must not be blocked or covered. The openings should never be blocked by placing the products on a bed, sofa, rug, or other similar surface. This product should never be placed near or over a radiator or heat register. This product should not be placed in a built-in installation such as a bookcase or rack unless proper ventilation is provided or the manufacturer's instructions have been adhered to.
10. **Power Sources.** This product should be operated only from the type of power source indicated on the marking labels. If you are not sure of the type of power supply to your home, consult your appliance dealer or local power company.
11. **Grounding or Polarization.** This product is equipped with polarized alternating-current line plugs (plugs having one blade wider than the other). This plug will fit into the power outlet only one way. This is a safety feature. If you are unable to insert the plug fully into the outlet, try reversing the plug. If the plug should still fail to fit, contact your electrician to replace your obsolete outlet. Do not defeat the safety purpose of the polarized plug.
12. **Power Cord Protection.** Power-supply cord should be routed so that it is not likely to be walked on or pinched by items placed upon or against it, paying particular attention to cords at plugs, convenience receptacles, and the point where they exit from the appliances.
13. **Lightning.** For added protection for this audio/video product during a lightning storm, or when it is left unattended and unused for long periods of time, unplug it from the wall outlet and disconnect the antenna or cable system. This will prevent damage to the product due to lightning and power-line surges.
14. **Power Lines.** An outside antenna system should not be located in the vicinity of overhead power lines or other electric light or power circuits, or where it can fall into such power lines or circuits. When installing an outside antenna system, extreme care should be taken to keep from touching such power lines or circuits as contact with them might be fatal.
15. **Overloading.** Do not overload wall outlets and extension cords as this can result in a risk of fire or electric shock.
16. **Object and Liquid Entry.** Never push objects of any kind into this product through openings, as they may touch dangerous voltage points or short out parts that could result in a fire or electric shock. Never spill liquid of any kind on this audio/video product.
17. **Servicing.** Do not attempt to service this product yourself, as opening or removing covers may expose you to dangerous voltage or other hazards. Refer all servicing to qualified service personnel.
18. **Damage Requiring Service.** Unplug this product from wall outlets and refer servicing to qualified service personnel under the following conditions:
 - a. When the power supply cord or plug is damaged.
 - b. If liquid has been spilled, or objects have fallen into the product.
 - c. If the product has been exposed to rain or water.
 - d. If the product does not operate normally by following the operating instructions. Adjust only those controls that are covered by the operating instructions, as an improper adjustment of other controls may result in damage and will often require extensive work by a qualified technician to restore the product to its normal operation.
 - e. If the product has been dropped or the cabinet has been damaged.
 - f. When the product exhibits a distinct change in performance—this indicates a need for service.

19. **Replacement Parts.** When replacement parts are required, be sure the service technician has used replacement parts specified by the manufacturer or that the parts have the same characteristics as the original part. Unauthorized substitutions may result in fire, electric shock or other hazards.
20. **Safety Check.** Upon completion of any service or repairs to this product, ask the service technician to perform safety checks to determine that the products are in proper operating condition.
21. **Carts and Stands.** The appliances should be used only with a cart or stand that is recommended by the manufacturer. An appliance and cart combination should be moved with care. Quick stops, excessive force, and uneven surfaces may cause the appliance and cart combination to overturn.

22. **This product is not intended for use outdoors.**



Product Disposal. Certain international, national and/or local laws and/or regulations may apply regarding the disposal of this product. For further detailed information, please contact the retailer where you purchased this product or the Polk Audio Importer/Distributor in your country. A listing of Polk Audio Importer/Distributors can be found on the Polk Audio website www.polkaudio.com or by contacting Polk Audio at 5601 Metro Drive, Baltimore, Maryland 21215, USA. Phone: +1-410-358-3600; in California: 1-800-377-7655.

CAUTION
RISK OF ELECTRIC SHOCK
DO NOT OPEN

**CAUTION: TO REDUCE THE RISK OF ELECTRIC SHOCK,
DO NOT REMOVE COVER (OR BACK)
NO USER-SERVICEABLE PARTS INSIDE
REFER SERVICING TO QUALIFIED SERVICE PERSONNEL**

The lightning flash with arrowhead symbol, within an equilateral triangle, is intended to alert the user to the presence of uninsulated dangerous voltage within the product's enclosure that may be of sufficient magnitude to constitute a risk of electric shock to persons.

The exclamation point within an equilateral triangle is intended to alert the user to the presence of important operating and maintenance (servicing) instructions in the literature accompanying the appliance.

WARNING
**TO REDUCE THE RISK OF FIRE OR ELECTRIC SHOCK,
DO NOT EXPOSE THIS APPLIANCE TO RAIN OR MOISTURE.**

**CAUTION: TO PREVENT ELECTRIC SHOCK, MATCH WIDE
BLADE OF PLUG TO WIDE SLOT, FULLY INSERT.**

**ATTENTION: POUR ÉVITER LES CHOCs ÉLECTRIQUES,
INTRODUIRE LA LAME LA PLUS LARGE DE LA
FICHE DANS LA BORNE CORRESPONDANTE DE LA
PRISE ET POUSSER JUSQU'AU FOND.**

For Your Records

Serial Number	Model Number	Purchase Date	Attach Receipt
Located on the bottom of your <i>I-Sonic™</i> Entertainment System.	No: <u>BM1125-A</u>	Date: _____	Staple your receipt here.
No: _____			

Table of Contents

3 <i>Safety Warning</i>	12 <i>Radio Operations:</i>
4 <i>For Your Records</i>	<i>Switch Time & Frequency Displays</i>
5 <i>Carton Contents</i>	<i>AM & FM Band</i>
5 <i>Introduction to I-Sonic™</i>	<i>Antenna Selection</i>
5 <i>The Polk Audio Story</i>	13 <i>XM Operations:</i>
6 <i>Special Features: HD Radio™</i>	<i>Selecting an XM Channel & Category</i>
7 <i>Special Features: XM Ready®</i>	<i>Aim the XM Antenna</i>
8 <i>I-Sonic Function Buttons</i>	<i>Change the Display</i>
8 <i>Side & Back Panel Hook-Ups</i>	14 <i>Presets for AM, FM & XM</i>
9 <i>Using the Remote Control</i>	14 <i>DVD, CD & MP3 Operations</i>
9 <i>Main Menu Screen</i>	15 <i>Settings:</i>
10 <i>Clock Settings</i>	<i>Sleep Mode</i>
10 <i>Alarm Settings</i>	<i>Bass & Treble</i>
11 <i>Radio Operations:</i>	<i>Change Display Brightness</i>
<i>Tuning the Radio</i>	<i>Change the Volume</i>
<i>Seek a Radio Station</i>	<i>Auxiliary Inputs</i>
<i>Scan Radio Stations</i>	16 <i>Warranty</i>

I-Sonic™

Introduction

Carton Contents

Take Inventory

Check to ensure you have everything in your *I-Sonic™ Entertainment System* carton to start enjoying your system.

Inside You Will Find

- *I-Sonic Entertainment System*
- Remote Control (Battery Included)
- AM External Antenna
- FM External Antenna
- Owner's Guide
- Online Registration Card

Important Note

If anything is missing or damaged, or if your *I-Sonic Entertainment System* fails to operate, notify your dealer immediately. We recommend keeping your original carton and packing materials in case you need to ship the unit in the future.

The All-In-One *I-Sonic™ Entertainment System* from Polk Audio

The Complete Entertainment System

Polk Audio's *I-Sonic™* is the first all digital format entertainment center, featuring the latest digital technologies—HD Radio™ with multicasting, XM Ready®, DVD player, and a high performance audio system in a convenient compact configuration.

With an *I-Sonic Entertainment System*, you will be able to enjoy the widest range of music, movies, news, information and entertainment available today and tomorrow.

To learn more go to: www.polkaudio.com/isonic/.

I-Sonic™ 4-Speaker Array & PowerPort® Technologies

Our exclusive *I-Sonic™* 4-speaker Array and patented PowerPort® technologies create beautiful stereo sound throughout an entire room. No matter where you sit, 360° around the *I-Sonic Entertainment System*, you hear a big, rich, room-filling stereo image.

Product Features

- Built-in DVD/CD player
- HD Radio™ technology
- XM Ready®
- AM/FM radio
- I-Pod® and other MP3 player connections
- Full function dual alarm clock radio
- Two auxiliary inputs
- Line level output (volume controlled)
- Headphone jack
- 30 radio presets for AM/FM/XM
- Compact size: 14 1/2" w x 9 3/4" d x 4 3/4" h

The Polk Audio Story

Products Born of Passion

Baltimore, Maryland-based Polk Audio is an award-winning manufacturer of high performance audio products. Founded by Chairman Matthew Polk and CEO George Klopfer in 1972, Polk Audio holds over 50 patents for advances in audio design and technology.

Polk's products include loudspeakers and electronic components for home, auto and marine applications. Polk also created the first XM satellite home component tuner, the world's first high-performance active IP-addressable loudspeaker, and the *I-Sonic Entertainment System*.

Polk Audio products are available through specialist consumer electronics retailers worldwide. For more information about Polk Audio and our products, go to: www.polkaudio.com

Polk Audio and PowerPort are registered trademarks of Britannia Investment Corporation used under license by Polk Audio Inc.

I-Sonic is a trademark of Britannia Investment Corporation used under license by Polk Audio Inc.

Special Features

HD Radio™ Technology & Multicasting

A Revolution In Radio

In what is the biggest technological change to radio since the introduction of FM in 1961, HD Radio™ technology is setting the standard for digital AM and FM radio in the US and around the world. HD Radio technology is transforming the radio experience in ways never thought possible. HD Radio broadcasting offers listeners of AM and FM Radio the quality, choice and interactive data services consumers have come to expect from digital technologies, and it is all subscription-free.

Features

- Multicasting, which is the ability to broadcast multiple program streams over a single FM frequency (97.7-2, 97.7-3, etc.), thereby increasing the amount and diversity of content choices
- Static-free, crystal-clear reception
- CD-quality sound on FM
- Digital AM; FM-stereo quality sound on AM
- Stations stay in their well-known, traditional place on the radio dial
- A variety of “data services” that could range from text-based information (artist name, song title, weather alerts, school closings and more) to live traffic reports, all of which would scroll across your receiver display.
- HD Radio receivers can also receive conventional analog broadcasts.

To find HD Radio stations in your area, please visit www.hdradio.com.

HD Radio™ Technology Manufactured Under License From iBiquity Digital Corporation. iBiquity Digital and the HD Radio and HD Symbols are trademarks of iBiquity Digital Corporation. U.S. and Foreign Patents.

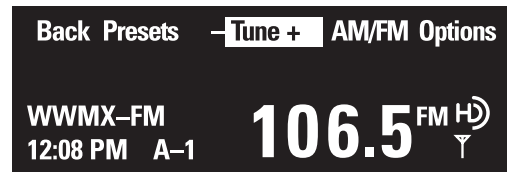

station broadcasting
in High Definition

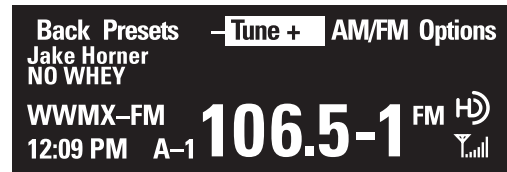

station broadcasting
in High Definition
multicasting

Special Features

XM Ready®

Introducing XM Satellite Radio

There's a world beyond AM and FM. XM Satellite Radio. Over 170 channels of music, news, sports, comedy, talk, and entertainment. Coast-to-coast coverage. Digital quality sound. With the most commercial-free music channels. Questions? Visit www.xmradio.com. Or in Canada visit www.xmradio.ca

Features

- Coast-to-coast coverage
- Over 170 channels
- Music, news, talk and sports
- Digital quality audio
- The most commercial-free channels

How to Subscribe

A subscription from XM Satellite Radio is required. To subscribe, contact XM on their website at www.xmradio.com or by calling XM's Listener Care at 800-852-9696 in the US. In Canada visit www.xmradio.ca or call 877-438-9677.

XM monthly service subscription sold separately. XM Passport system required to receive XM service (sold separately).

Installation costs and other fees and taxes, including a one-time activation fee, may apply. Subscription fee is consumer only. All fees and programming subject to change. Channels with frequent explicit language are indicated with an XL. Channel blocking is available for XM radio receivers by calling 1-800-XMRADIO. Subscriptions subject to Customer Agreement available at xmradio.com. XM service only available in the 48 contiguous United States. XM Ready is a trademark of XM Satellite Radio Inc. © 2006 XM Satellite Radio Inc. All rights reserved.

Note

The XM Passport antenna or CNP-1000 is required (sold separately at www.polkaudio.com). For more information go to www.xmradio.com; in Canada www.xmradio.ca.

XM Ready Legal Disclaimers

"XM Ready® Products:" An XM Ready product is a product that has incorporated minimal technology to support the XM Service via an external/receiver chipset such as XM Direct®, which are sold separately. XM Ready products do not have the full XM receiver functionality into the main product configuration but require the addition of an off-board receiver accessory to make a complete XM Radio System.

Technology Warning

It is prohibited to copy, decompile, disassemble, reverse engineer, or manipulate any technology incorporated in receivers compatible with the XM Satellite Radio system. Furthermore, the AMBE (R) voice compression software included in this product is protected by intellectual property rights, including patent rights, copyrights and trade secrets of Digital Voice Systems, Inc. The user of this or any other software contained in an XM Radio is explicitly prohibited from attempting to copy, decompile, reverse engineer, or disassemble the object code, or in any other way convert the object code into human-readable form. The software is licensed solely for use within this product.

XM and XM Ready are registered trademarks of XM Satellite Radio Inc.



XM channel menu with small display selected



XM channel menu with large display selected

Function Buttons & Back Panel Hook-Ups

Using the I-Sonic Console Buttons

Your Favorite Entertainment At Your Fingertips

All the functions on your I-Sonic™ Entertainment System are conveniently controlled by a compact remote control.

The I-Sonic Entertainment System also features a complement of buttons that allow you to control all system functions.

You never have to worry about misplacing the remote control. Whichever mode you are most comfortable using, the incredible sound and versatility of the I-Sonic Entertainment System are always at your fingertips.

To learn more go to: www.polkaudio.com/isonic/.

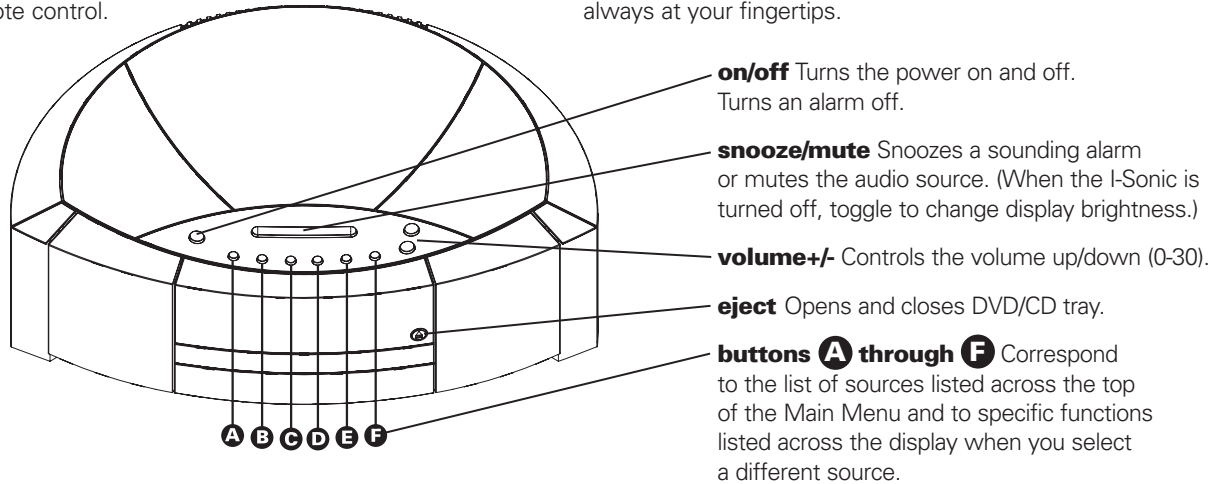

I-Sonic Side Panel Hook-Ups

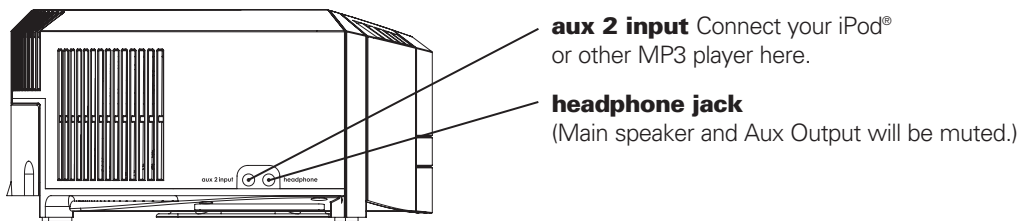

I-Sonic Back Panel Hook-Ups

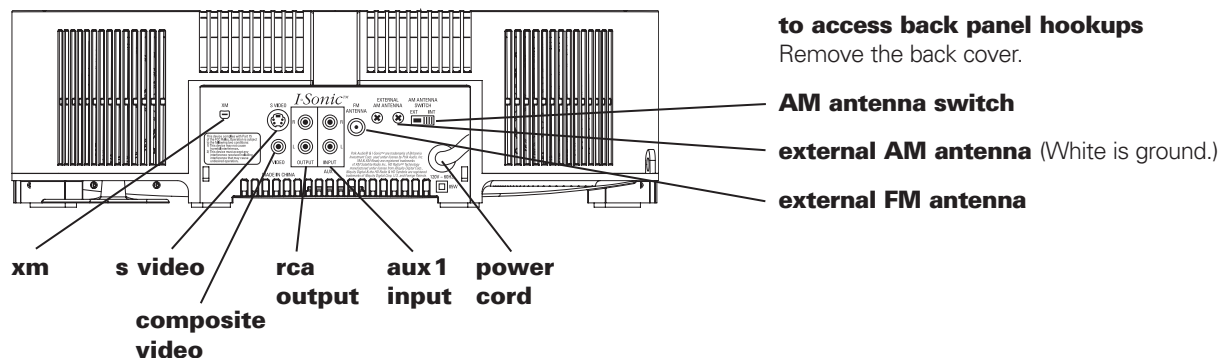

Remote Control & Main Menu Features

Using the Remote Control

source buttons Selects a specific play mode as well as Aux 1 and 2.

on/off/alarm Turns power on or off; turns alarm off.

volume+/-

eject Opens or closes DVD/CD tray.

sleep Sets sleep time. (15, 30, 45, 60 or 90 min.)

snooze/mute Snoozes a sounding alarm or silences an audio source.

alarm 1 Turns alarm 1 on/off.

set 1 Selects alarm 1 settings menu.

alarm 2 Turns alarm 2 on/off.

set 2 Selects alarm 2 settings menu.

track Moves forward & backward to the next CD track or DVD chapter. To fast forward, press & hold. (Increases speed 2x, 4x, 8x, 16x, 32x).

play/pause Toggles between play & pause.

stop Stops a DVD/CD.

subtitle Displays next DVD subtitle option; cycle through on/off/subtitle tracks.

title Displays a DVD title menu.

menu Displays the DVD menu.

audio Selects next DVD audio option.

presets Calls up stored AM/FM/XM stations; toggle to call up Bank A, B or C. Preset + [number key] recalls that preset.

shift Press this key plus specific keys to access other functions labeled in red.

castle Composed of the four triangle keys and enter key.

The castle allows you to move through all menus (◀▶ keys) and find a radio station (▲▼ keys). The **enter** key lets you select a source or setting.

XM castle Use ▲▼ keys to move +/- channels. Use ◀▶ keys to move through menu. Use **enter** key to select.

HD castle Use ▲▼ keys to move +/- **tune**. Hold, then release ▲▼ keys for **seek** mode. Use ◀▶ keys to move through menu. Use **enter** key to select.

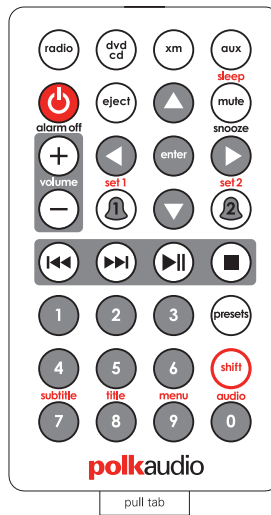

to activate the remote
Remove the plastic tab.

The remote control operates the I-Sonic™ Entertainment System using a similar menu structure as the buttons on the unit. Navigation to all other sources or settings begins with the Main Menu.

Main Menu Screen—Press On/Off to Activate Unit

status messages

These message fields will show alarm information, radio station/metadata, clock time, HD signal acquisition and strength. (Example indicates Alarm 1 is on; tone is the wake-up source; alarm time is 7:00am). No information is displayed for Alarm 2, indicating it is turned off.



buttons A through F

Correspond to the menu items listed across the top of the display. Each source has its own menu. Selecting **settings** or **options** (button F) initiates a drop-down menu, which displays a list of operations.

highlighted box Indicates the current selection.

idle When I-Sonic is turned off, time and status messages will be displayed.

Clock & Alarm Settings

Set the Clock for the First Time

Default display indicates time must be set the first time unit is plugged in or is left without power for more than 3 days.

With an XM Passport antenna connected, the time will set itself.

daylight savings/time zone

A B C D E F

1 Back DST OFF - Time + Enter
 Select Time Zone DST On
 (GMT - 4:00) Atlantic
 (GMT - 5:00) Eastern
 (GMT - 6:00) Central
 (GMT - 7:00) Mountain

- B** DST on or off.
- C D** Select time zone.
- F** Enter. (DST status, shown under "Enter," is on.)

settings menu

A B C D E F

2 Back 12/24 Hr - Time + AM/PM Enter
 Time must be set
 Set Time **12:00** PM

- B** Select 12 or 24 hour clock.
- C D** Decrease/Increase time.
- E** Select AM or PM.
- F** Enter.

Clock Settings

from Main Menu Select "Settings" **F**

settings menu

A B C D E F

1 Back SLEEP Bass Treble Display Clock
 System +1 0 High
 Settings = -

- F** Clock menu.

daylight savings/time zone

A B C D E F

2 Back DST OFF - Time + Enter
 Select Time Zone DST On
 (GMT - 4:00) Atlantic
 (GMT - 5:00) Eastern
 (GMT - 6:00) Central
 (GMT - 7:00) Mountain

- B** DST on or off.
- C D** Select time zone.
- F** Enter.

clock menu

A B C D E F

3 Back 12/24 Hr - Time + AM/PM Enter
 Set Time **2:10** PM

- B** Select 12 or 24 hour clock.
- C D** Decrease/Increase time.
- E** Select AM or PM.
- F** Enter.

Alarm Settings

from Main Menu Select "Alarm" **A**

alarm menu

A B C D E F

1 Back Set On/Off Set On/Off
 Alarm 1 On Alarm 2 On
10:00 AM **5:45** PM

- B** Set alarm 1.
 Remote: +
- E** Set alarm 2.
 Remote: +

alarm 1 set-up menu

A B C D E F

2 Back Source - Time + AM/PM On/Off
 Tone On
 Set Alarm 1 **10:00** AM

- B** Select alarm source.
- C D** Decrease/Increase time.
- E** Select AM or PM.
- F** Select alarm on or alarm off

alarm 2 set-up menu

A B C D E F

3 Back Source - Time + AM/PM On/Off
 Tone On
 Set Alarm 2 **5:45** AM

- A** Exit from alarm menu.
 NOTE: AFTER NO KEY HAS BEEN PRESSED FOR 5 SECONDS, DISPLAY RETURNS TO MAIN MENU.

ALARM SOURCES:

TONE, RADIO (LAST STATION), **XM** (LAST CHANNEL), **DVD/CD, AUX 1 & 2, PRESET** (PRESET A1: ALARM 1), **PRESET** (PRESET B1: ALARM 2)

ALARM VOLUME: INCREASES EVERY 5 SECONDS UP TO YOUR LAST VOLUME SETTING

Radio Operations

Tuning the Radio

from Main Menu Select "Radio" **B**

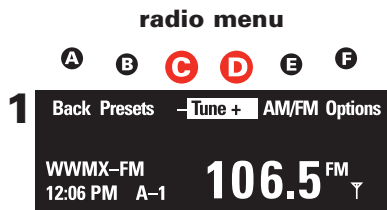

- C** Tune to a lower station.
Remote: ▼
- D** Tune to a higher station.
Remote: ▲

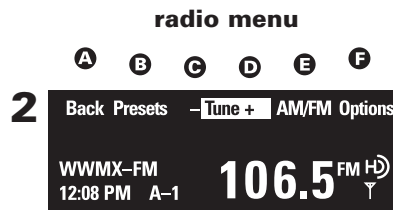

Same station in HD when icon appears.

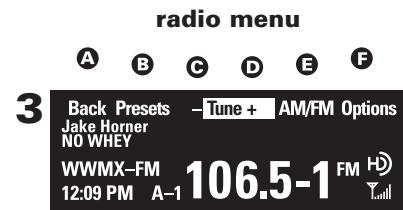

Same station in HD multicast.
NOTE: THIS DISPLAY INDICATES AN ADDITIONAL SUB-CHANNEL MAY BE AVAILABLE.

Seek a Radio Station

from Main Menu Select "Radio" **B**

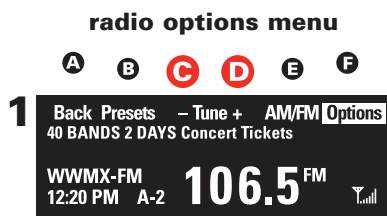

- C** Press down 2 secs. for seek mode. Release button to seek a lower station. Remote: ▼
- D** Press down 2 seconds to seek a higher station. Remote: ▲



- C** Seek a lower station.
Remote: ▼
- D** Seek a higher station.
Remote: ▲

seek

This mode finds the next strong station signal and stops on that station.

linking

When your I-Sonic is "seeking" down the radio band and finds an HD supplemental channel, the message "linking" will appear as it acquires the channel.

Scan Radio Stations

from Main Menu Select "Radio" **B**

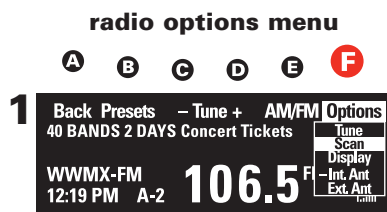

- F** Select Options.
Toggle to Scan.

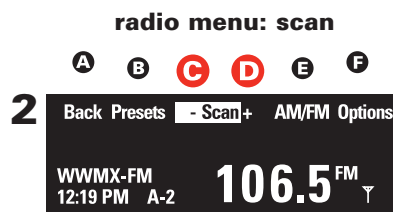

- C** Scan a lower station.
Remote: ▼
- D** Scan a higher station.
Remote: ▲

scan

This mode finds a strong station signal, stays on this station for 10 seconds, then finds the next strongest station signal. Press either -/+ Scan (C or D) to lock onto the station.

Radio Operations

Switch Time & Frequency Displays

from Main Menu Select "Radio" **B**

radio menu: station display

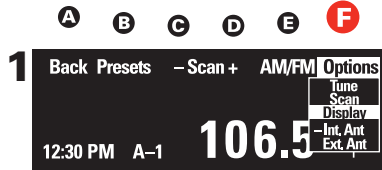

F If station frequency is displayed, select options. Toggle to "Display." Time will appear.

radio menu: time display



F If current time is displayed, select options. Toggle to "Display." Station will appear.

AM & FM Band

from Main Menu Select "Radio" **B**

radio menu: am/fm

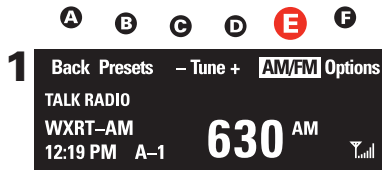

E Select AM band.

radio menu: am/fm

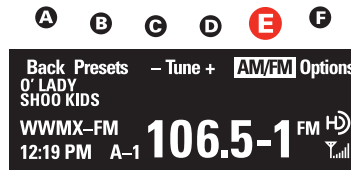

E Select FM band.

Antenna Selection

from Main Menu Select "Radio" **B**

radio menu: fm int. antenna



F Toggle to "Int. Antenna."
 Dash indicates current selection.

radio menu: fm ext. antenna



F Toggle to "Ext. Antenna."
 Dash indicates current selection.

NOTE: FOR AM ANTENNA USE THE MANUAL "AM ANTENNA SWITCH" ON THE BACK OF THE UNIT.

XM Operations

Selecting an XM Channel & Category

from Main Menu Select "XM" **D**

xm channel menu

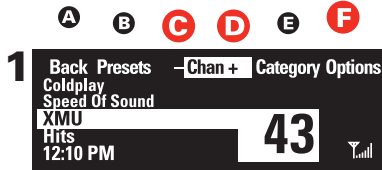

- C** Select a lower channel.
Remote:
- D** Select a higher channel.
Remote:
- F** Select additional XM options.

xm channel select menu

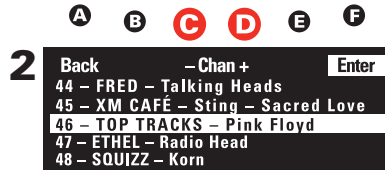

- C** Select a lower channel.
Remote:
- D** Select a higher channel.
Remote:

xm channel menu

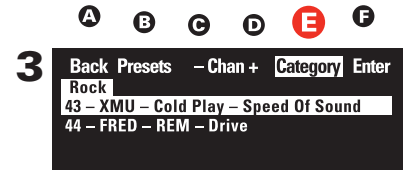

- E** Toggle through various categories.

NOTE: XM Satellite Radio Antenna sold separately at www.polkaudio.com.

TO ACTIVATE XM SATELLITE RADIO: Call 800-852-9696 in the US or in Canada, 877-438-9677.

xm options menu

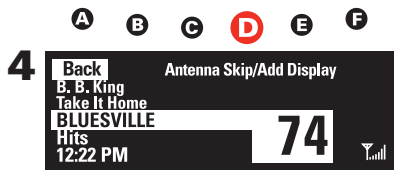

- D** Skip/Add a channel.

xm skip/add menu

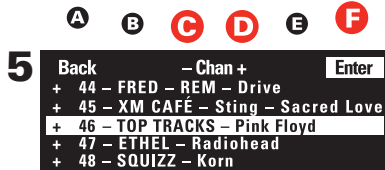

- C** Select a lower channel.
Remote:
- D** Select a higher channel.
Remote:
- F** Skip/Add a channel.

xm status displays

channel status



Displayed when "loading," "off air," or unavailable.

updating



Displayed when encryption code has been changed.

antenna



Displayed if XM antenna or Passport is not connected.

signal



Displayed if signal strength is too low.

Aim the XM Antenna

from XM Options Menu Select "Antenna" **C**

xm antenna aiming menu

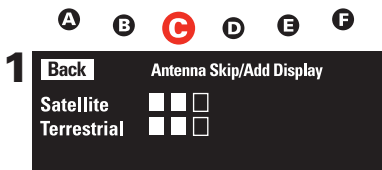

- C** Signal strength shown when adjusting direction of XM antenna.

Change the Display

from XM Options Menu Select "Display" **F**

xm menu: channel display



- F** Toggle between small or large channel display. Large display channel shown here.

Presets for AM, FM & XM

Select a Preset

from Radio or XM Menu Select "Presets" **B**

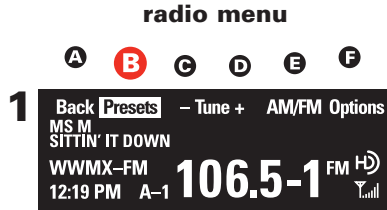

- B** Preset a radio station.
Remote:

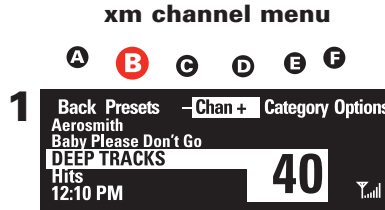

- B** Preset an XM channel.
Remote:

Navigate a Preset

from Radio or XM Menu Select "Presets" **B**

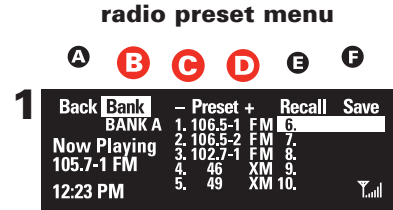

- B** Selects banks A, B and C.
Toggle remote:
- C** Moves down the banks.
D Moves up the banks.

Save a Preset

from Radio or XM Menu Select "Save" **F**

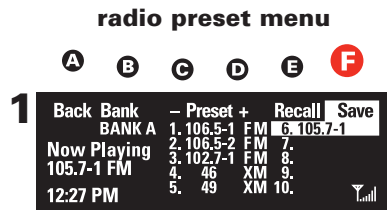

- F** Saves the station that is currently playing.
Holding **F** for 2 seconds deletes the preset.

Recall a Preset

from Radio or XM Menu Select "Recall" **E**

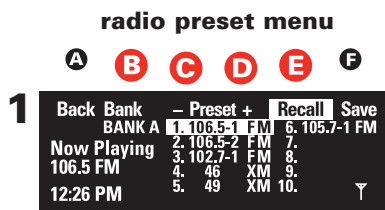

- B** Select a preset bank.
C Moves down the banks.
D Moves up the banks.
E Recall the station.
Remote: keys 1-10

NOTE: HOLDING PRESET WILL SAVE THE CURRENT STATION INTO THE NEXT AVAILABLE PRESET LOCATION.

DVD, CD & MP3 Operations

Play a DVD Disc

from Main Menu Select "DVD/CD" **C**



Eject button on I-Sonic opens & closes DVD/CD tray. Remote:

NOTE: CASTLE WILL NAVIGATE THE ON-SCREEN DISPLAY OF THE DVD DISC, BUT IT WILL NOT NAVIGATE THE MENUS ON THE I-SONIC IN THE DVD MODE.

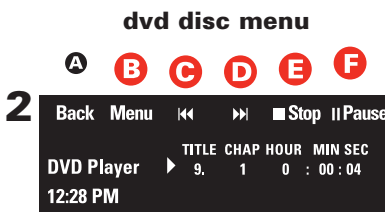

- B** Navigates DVD Menu.

- C** Remote: For previous chapters/tracks.
FOR FAST REWIND, PRESS & HOLD.
- D** Remote: Next chapters/tracks.
FOR FAST FORWARD, PRESS & HOLD.

Play a CD & MP3 Disc

from Main Menu Select "DVD/CD" **C**

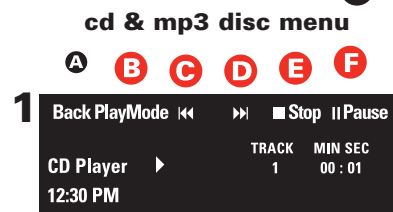

- B** "Shuffle," "repeat one" or "repeat all."
NOTE: SAME SCREEN OPTIONS FOR MP3.

- E** Remote: Stop disc.
F Remote: Play/Pause disc.
TOGGLES BETWEEN PLAY & PAUSE.

dvd, cd & mp3 operations

Settings

Sleep Mode

from Main Menu Select "Settings" **F**

system settings menu

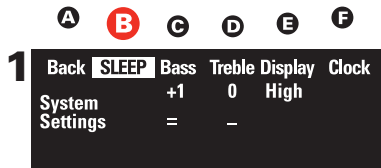

B Select for sleep timer.

sleep menu



B Toggle to set sleep time to 15min., 30 min., 45min., 60min. or 90min.
Remote:

Bass & Treble

from Settings Menu Select "Bass" **C** or "Treble" **D**

systems settings menu



C Select bass.
D Select treble.

bass settings menu

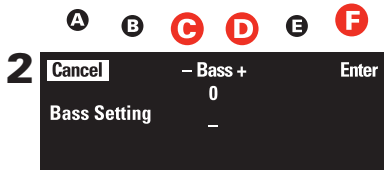

C Lower bass level adjustment.
D Higher bass level adjustment.
F Enter to save settings.

NOTE: SAME SCREEN OPTIONS FOR TREBLE SETTINGS.

Change Display Brightness

from Settings Menu Select "Display" **E**

settings menu



E Toggle to set display brightness to high, medium or low. Remote:

NOTE: THE "LOW" SETTING IS GOOD FOR SLEEPING.

Change the Volume

from Settings Menu Select "Display" **E**

volume menu

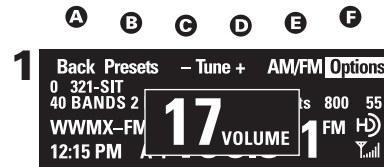

Select volume +/- (0-30) on top of I-Sonic or Remote:

Auxiliary Inputs

from Main Menu Select "Aux In" **E**

main menu



E Toggle to select Aux 1 or Aux 2. Remote:

Warranty

Limited One Year Warranty

Polk Audio, Inc., warrants to the original retail purchaser only. This warranty will terminate automatically prior to its stated expiration if the original retail purchaser sells or transfers the Product to any other party.

Polk Audio, Inc., warrants, to the original retail purchaser only, that this Product will be free from defects in material and workmanship for a period of one (1) year from the date of original retail purchase from a Polk Audio Authorized Dealer.

To allow Polk Audio to offer the best possible warranty service, please register your new product online at: www.polkaudio.com/registration or call Polk customer service 800-377-7655 in the USA within ten (10) days of the date of original purchase. Be sure to keep your original purchase receipt.

Defective Products must be shipped, together with proof of purchase, prepaid insured to the Polk Audio Authorized Dealer from whom you purchased the Product, or to the Factory at 2550 Britannia Boulevard, Suite A, San Diego, California 92154. Products must be shipped in the original shipping container or its equivalent; in any case the risk of loss or damage in transit is to be borne by you. If upon examination at the Factory or Polk Audio Authorized Dealer it is determined that the unit was defective in materials or workmanship at any time during this Warranty period, Polk Audio or the Polk Audio Authorized Dealer will, at its option, repair or replace this Product at no additional charge, except as set forth below.

All replaced parts and Products become the property of Polk Audio. Products replaced or repaired under this warranty will be returned to you, within a reasonable time, freight prepaid.

This warranty does not include service or parts to repair damage caused by accident, disaster, misuse, abuse, negligence, inadequate packing or shipping procedures, commercial use, voltage inputs in excess of the rated maximum of the unit, cosmetic appearance of cabinetry not directly attributable to defect in materials or workmanship, or service, repair, or modification of the Product which has not been authorized or approved by Polk Audio. This warranty shall terminate if the Serial number on the Product has been removed, tampered with or defaced.

This warranty is in lieu of all other expressed Warranties. If this Product is defective in materials or workmanship as warranted above, your sole remedy shall be repair or replacement as provided above. In no event will Polk Audio, Inc. be liable to you for any incidental or consequential damages arising out of the use or inability to use the Product, even if Polk Audio, Inc. or a Polk Audio Authorized Dealer has been advised of the possibility of such damages, or for any claim by any other party. Some states do not allow the exclusion or limitation of consequential damages, so the above limitation and exclusion may not apply to you.

All implied warranties on this Product are limited to the duration of this expressed Warranty. Some states do not allow limitation on how long an implied Warranty lasts, so the above limitations may not apply to you. This Warranty gives you specific legal rights, and you also may have other rights which vary from state to state.

This Warranty applies only to Products purchased in Canada, the United States of America, its possessions, and U.S. and NATO armed forces exchanges and audio clubs.

The Warranty terms and conditions applicable to Products purchased in other countries are available from the Polk Audio Authorized Distributors in such countries.

Free Manuals Download Website

<http://myh66.com>

<http://usermanuals.us>

<http://www.somanuals.com>

<http://www.4manuals.cc>

<http://www.manual-lib.com>

<http://www.404manual.com>

<http://www.luxmanual.com>

<http://aubethermostatmanual.com>

Golf course search by state

<http://golfingnear.com>

Email search by domain

<http://emailbydomain.com>

Auto manuals search

<http://auto.somanuals.com>

TV manuals search

<http://tv.somanuals.com>