

Warranty, Copyright, Safety Notices

LIMITED WARRANTY. Polycorn warrants to the end user ("Customer") that this product will be free from defects in workmanship and materials, under normal use and service, for one year from the date of purchase from Polycorn or its authorized reseller.

Polycorn's sole obligation under this express warranty shall be, at Polycorn's option and expense, to repair the defective product or part, deliver to Customer an equivalent product or part to replace the defective item, or if neither of the two foregoing options are reasonably available, Polycorn may, on its sole discretion, refund to Customer the purchase price paid for the defective product. All products that are replaced will become the property of Polycorn. Replacement products or parts may be new or reconditioned. Polycorn warrants any replaced or repaired product or part for ninety (90) days from shipment, or the remainder of the initial warranty period, whichever is longer.

Products returned to Polycorn must be sent prepaid and packaged appropriately for safe shipment, and it is recommended that they be insured or sent by a method that provides for tracking of the package. Responsibility for loss or damage does not transfer to Polycorn until the returned item is received by Polycorn. The repaired or replaced item will be shipped to Customer, at Polycorn's expense, not later than thirty (30) days after Polycorn receives the defective product, and Polycorn will retain risk of loss or damage until the item is delivered to Customer.

EXCLUSIONS. Polycorn will not be liable under this limited warranty if its testing and examination disclose that the alleged defect or malfunction in the product does not exist or results from:

- Failure to follow Polycorn's installation, operation, or maintenance instructions.
- Unauthorized product modification or alteration.
- Unauthorized use of common carrier communication services accessed through the product.
- Abuse, misuse, negligent acts or omissions of Customer and persons under Customer's control; or
- Acts of third parties, acts of God, accident, fire, lightning, power surges or outages, or other hazards.

WARRANTY EXCLUSIVE. IF A POLYCOM PRODUCT DOES NOT OPERATE AS WARRANTED ABOVE, CUSTOMER'S SOLE REMEDY FOR BREACH OF THAT WARRANTY SHALL BE REPAIR, REPLACEMENT, OR REFUND OF THE PURCHASE PRICE PAID, AT POLYCOM'S OPTION. TO THE FULL EXTENT ALLOWED BY LAW, THE FOREGOING WARRANTIES AND REMEDIES ARE EXCLUSIVE AND ARE IN LIEU OF ALL OTHER WARRANTIES, TERMS, OR CONDITIONS, EXPRESS OR IMPLIED, EITHER IN FACT OR BY OPERATION OF LAW, STATUTORY OR OTHERWISE, INCLUDING WARRANTIES, TERMS, OR CONDITIONS OF MERCHANTABILITY, FITNESS FOR A PARTICULAR PURPOSE, SATISFACTORY QUALITY,

COPYRIGHT. All rights reserved under International and pan-American Copyright Conventions. No part of the contents of this manual may be copied, reproduced, or transmitted in any form or by any means, or translated into another language or format, in whole or part, without written consent of Polycorn, Inc. Polycorn® and the logo design are registered trademarks and SoundPoint® IP 501 is a trademark of Polycorn, Inc. in the United States, and various countries.

SAFETY AND REGULATORY INFORMATION. This device complies with Part 15 of the FCC Rules. Operation is subject to the following two conditions:

- (1) This device may not cause harmful interference, and (2) This device must accept any interferences received, including interference that may cause undesired operation.

Note: This equipment has been tested and found to comply with the limits for a Class B digital device, pursuant to Part 15 of the FCC Rules. These limits are designed to provide reasonable protection against harmful interference when the equipment is operated in a commercial environment. This equipment generates, uses, and can radiate radio frequency energy and, if not installed and used in accordance with the instructions, may cause harmful interference to radio communications. Operation of this equipment in a residential area is likely to cause harmful interference in which case the user will be required to correct the interference at his own expense. This SoundPoint® IP 501 has been marked with the CE mark. This mark indicates compliance with EEC directives 89/336/EEC and 73/23/EEC. A full copy of the Declaration of Conformity can be obtained from Polycorn Ltd., 270 Bath Road, Slough, Berkshire, SL1 4DX, UK.

CORRESPONDENCE WITH DESCRIPTION, AND NON-INFRINGEMENT, ALL OF WHICH ARE EXPRESSLY DISCLAIMED. POLYCOM NEITHER ASSUMES NOR AUTHORIZES ANY OTHER PERSON TO ASSUME FOR IT ANY OTHER LIABILITY IN CONNECTION WITH THE SALE, INSTALLATION, MAINTENANCE OR USE OF ITS PRODUCTS.

SERVICE AGREEMENTS. Please contact your Polycorn Authorized Reseller for information about service agreements applicable to your product.

LIMITATION OF LIABILITY. LIMITATION OF LIABILITY. TO THE FULL EXTENT ALLOWED BY LAW, POLYCOM EXCLUDES FOR ITSELF AND ITS SUPPLIERS ANY LIABILITY, WHETHER BASED IN CONTRACT OR TORT (INCLUDING NEGLIGENCE), FOR INCIDENTAL, CONSEQUENTIAL, INDIRECT, SPECIAL, OR PUNITIVE DAMAGES OF ANY KIND, OR FOR LOSS OF REVENUE OR PROFITS, LOSS OF BUSINESS, LOSS OF INFORMATION OR DATA, OR OTHER FINANCIAL LOSS ARISING OUT OF OR IN CONNECTION WITH THE SALE, INSTALLATION, MAINTENANCE, USE, PERFORMANCE, FAILURE, OR INTERRUPTION OF ITS PRODUCTS, EVEN IF POLYCOM OR ITS AUTHORIZED RESELLER HAS BEEN ADVISED OF THE POSSIBILITY OF SUCH DAMAGES, AND LIMITS ITS LIABILITY TO REPAIR, REPLACEMENT, OR REFUND OF THE PURCHASE PRICE PAID, AT POLYCOM'S OPTION. THIS DISCLAIMER OF LIABILITY FOR DAMAGES WILL NOT BE AFFECTED IF ANY REMEDY PROVIDED HEREIN SHALL FAIL OF ITS ESSENTIAL PURPOSE.

DISCLAIMER. Some countries, states, or provinces do not allow the exclusion or limitation of implied warranties or the limitation of incidental or consequential damages for certain products supplied to consumers, or the limitation of liability for personal injury, so the above limitations and exclusions may be limited in their application to you. When the implied warranties are not allowed to be excluded in their entirety, they will be limited to the duration of the applicable written warranty. This warranty gives you specific legal rights which may vary depending on local law. **GOVERNING LAW.** This Limited Warranty and Limitation of Liability shall be governed by the laws of the State of California, U.S.A., and by the laws of the United States, excluding their conflicts of laws principles. The United Nations Convention on Contracts for the International Sale of Goods is hereby excluded in its entirety from application to this Limited Warranty and Limitation of Liability. All rights reserved under International and Pan-American Copyright Conventions. No part of the contents of this manual may be copied, reproduced, or transmitted in any form or by any means, or translated into another language or format, in whole or part, without written consent from Polycorn, Inc. Do not remove (or allow anybody else to remove) any product identification, copyright or other notices. Polycorn, the Polycorn logo design, and SoundPoint are trademarks of Polycorn, Inc. in the U.S. and various other countries.

Do not remove (or allow any third party to remove) any product identification, copyright or other notices.

The software contained within this product is protected by United States copyright laws and international treaty provisions. Polycorn, Inc., retains title and ownership of all property rights with respect to the software within this product.

In accordance with Part 15 of the FCC Rules, the user is cautioned that any changes or modifications not expressly approved by Polycorn, Inc. could void the user's authority to operate the equipment.

Installation must be performed in accordance with all relevant national wiring rules. L'Installation doit être exécutée conformément à tous les règlements nationaux applicables au filage électrique.

The outlet to which this apparatus is connected must be installed near the equipment and must always be readily accessible.

La prise électrique à laquelle l'appareil est branché doit être installée près de l'équipement et doit toujours être facilement accessible.

This Class [B] digital apparatus complies with Canadian ICES-003.

Cet appareil numérique de la classe [B] sera conforme à la norme NMB-003 du Canada.

Contact Information:

Please contact your Polycorn Authorized Reseller for assistance.

<http://www.polycom.com>

Polycorn, Inc. 1565 Barber Lane, Milpitas, CA 95035 USA



1725-11528-001 Rev. A

SoundPoint® IP 501 Quick Start Guide

Thank you for choosing the full-duplex, handsfree SoundPoint® IP 501, a telephone that provides business telephony

features and functions such as Multiple Call Appearances, Call Hold, Transfer, and Conferencing over an IP network.

Unpacking the SoundPoint® IP 501

The following items are included in your SoundPoint® IP 501 package. Check this list before installation to ensure that you have received each item. If you are missing any items, please contact your SoundPoint® IP 501 reseller.

To help us serve you better, please take a moment now to complete and mail your registration card.

SoundPoint® IP 501
Base Unit

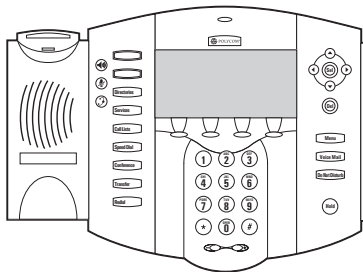

Power Adapter
(Country specific)

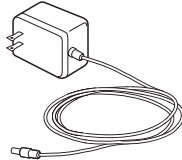

Network / Power Cable

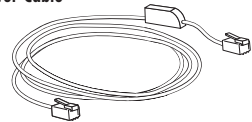

Handset and
Cord

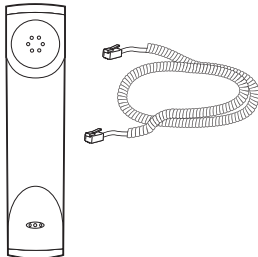

Base Stand

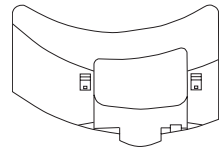

Wallmount
Bracket
(not included with
this package but
may be purchased
from your reseller)



Quick Start Guide and
Registration Card

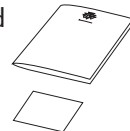

Windowed Keycaps
Blank Label Sheet

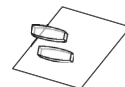

SoundPoint® IP 501 Quick Start Guide

Download from www.Somanuals.com. All Manuals Search And Download.

Installation

1 Connecting Headset and Handset

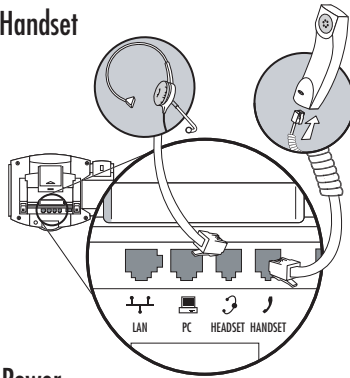

2 Connecting Network and Power

AC Power Option:

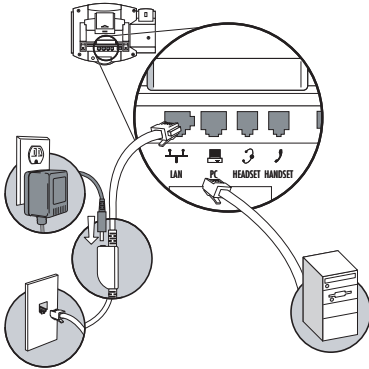

In-Line Power Option:

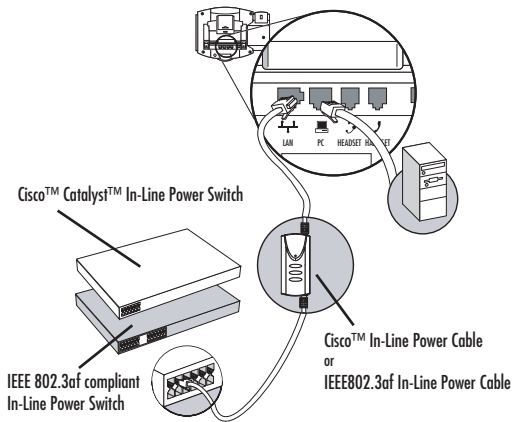

3 Attaching the Base:

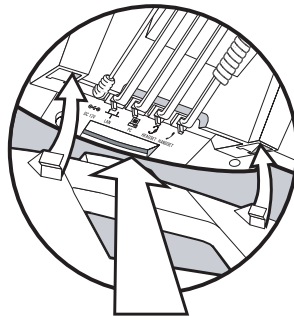
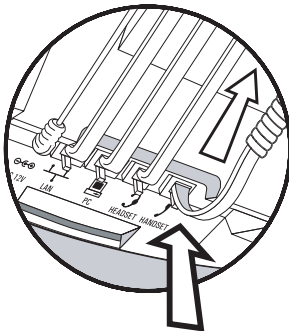

SoundPoint® IP 501 Features and Functions

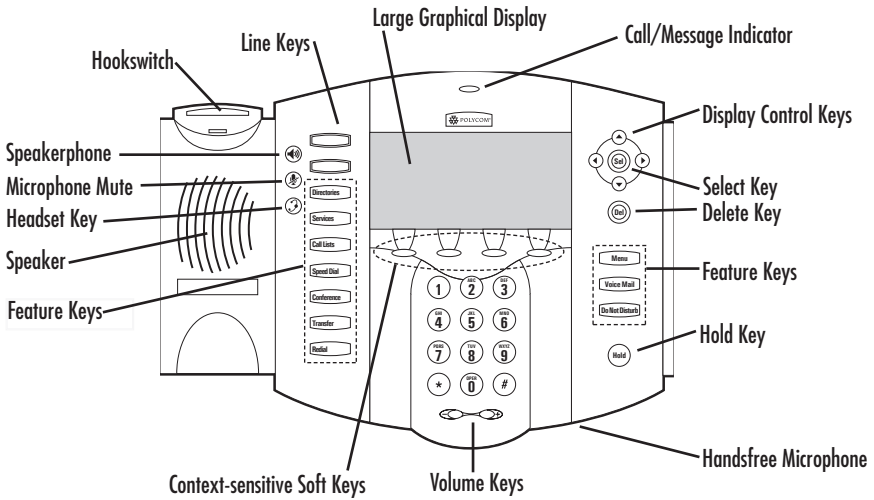

SoundPoint® IP 501 Start Up

The SoundPoint® IP 501 telephone starts up as soon as power is applied. Several verification steps follow (depending on how the telephone has been configured by your System Administrator):

1. Obtain network settings (DHCP, SNTP, etc.).
2. Load Configurable Applications and Services.
3. Load main software.

The SoundPoint® IP 501 is ready to use when a screen similar to below appears. For further instructions on how to use your new SoundPoint® IP 501, please consult the User Guide for the particular software running on the telephone.

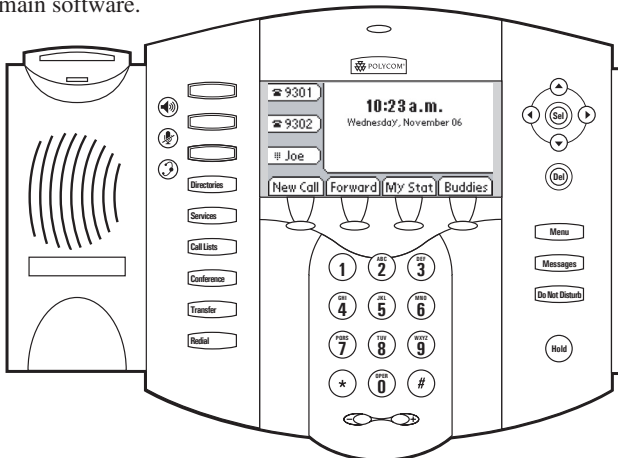

Free Manuals Download Website

<http://myh66.com>

<http://usermanuals.us>

<http://www.somanuals.com>

<http://www.4manuals.cc>

<http://www.manual-lib.com>

<http://www.404manual.com>

<http://www.luxmanual.com>

<http://aubethermostatmanual.com>

Golf course search by state

<http://golfingnear.com>

Email search by domain

<http://emailbydomain.com>

Auto manuals search

<http://auto.somanuals.com>

TV manuals search

<http://tv.somanuals.com>