

ESPAÑOL: PÁGINA 15
FRANÇAISE : PAGE 31

Instruction manual

Cordless Jigsaw



MODEL 643



MODEL 8924

To learn more about Porter-Cable
visit our website at:

<http://www.porter-cable.com>

PORTER-CABLE
PROFESSIONAL POWER TOOLS

Copyright © 2001 Porter-Cable Corporation

PATENT PENDING

IMPORTANT

Please make certain that the person who is to use this equipment carefully reads and understands these instructions before starting operations.

The Model and Serial No. plate is located on the main housing of the tool. Record these numbers in the spaces below and retain for future reference.

Model No. _____

Type _____

Serial No. _____

Part No. 908937 - 12-20-02

⚠ WARNING: SOME DUST CREATED BY POWER SANDING, SAWING, GRINDING, DRILLING, AND OTHER CONSTRUCTION ACTIVITIES

contains chemicals known to cause cancer, birth defects or other reproductive harm. Some examples of these chemicals are:

- lead from lead-based paints,
- crystalline silica from bricks and cement and other masonry products, and
- arsenic and chromium from chemically-treated lumber.

Your risk from these exposures varies, depending on how often you do this type of work. To reduce your exposure to these chemicals: work in a well ventilated area, and work with approved safety equipment, such as those dust masks that are specially designed to filter out microscopic particles.

GENERAL SAFETY RULES FOR ALL BATTERY OPERATED TOOLS

⚠ WARNING: READ AND UNDERSTAND ALL INSTRUCTIONS.

Failure to follow all instructions listed below, may result in electric shock, fire and/or serious personal injury.

SAVE THESE INSTRUCTIONS.

WORK AREA

- 1. Keep your work area clean and well lit.** Cluttered benches and dark areas invite accidents.
- 2. Do not operate power tools in explosive atmospheres, such as in the presence of flammable liquids, gases, or dust.** Power tools create sparks which may ignite the dust or fumes.
- 3. Keep bystanders, children, and visitors away while operating a power tool.** Distractions can cause you to lose control.

ELECTRICAL SAFETY

- 1. The battery pack must be recharged only with the specified charger for the battery.** A charger that may be suitable for one type of battery may create a risk of fire when used with another battery.
- 2. Use battery operated tool only with specifically designated battery pack.** Use of any other batteries may create a risk of fire.

PERSONAL SAFETY

- 1. Stay alert, watch what you are doing, and use common sense when operating a power tool. Do not use tool while tired or under the influence of drugs, alcohol, or medication.** A moment of inattention while operating power tools may result in serious personal injury.
- 2. Dress properly. Do not wear loose clothing or jewelry. Contain long hair. Keep your hair, clothing, and gloves away from moving parts.** Loose clothes, jewelry, or long hair can be caught in moving parts.
- 3. Avoid accidental starting. Be sure switch is in the locked or off position before inserting battery pack.** Carrying tools with your finger on the switch or inserting the battery pack into a tool with the switch on invites accidents.
- 4. Remove adjusting keys or wrenches before turning the tool on.** A wrench or a key that is left attached to a rotating part of the tool may result in personal injury.
- 5. Do not overreach. Keep proper footing and balance at all times.** Proper footing and balance enable better control of the tool in unexpected situations.
- 6. Use safety equipment. Always wear eye protection.** Dust mask, non-skid safety shoes, hard hat, or hearing protection must be used for appropriate conditions.

TOOL USE AND CARE

- 1. Use clamps or other practical way to secure and support the workpiece to a stable platform.** Holding the work by hand or against your body is unstable and may lead to loss of control.
- 2. Do not force tool. Use the correct tool for your application.** The correct tool will do the job better and safer at the rate for which it is designed.
- 3. Do not use tool if switch does not turn it on or off.** A tool that cannot be controlled with the switch is dangerous and must be repaired.
- 4. Disconnect battery pack from tool and place the switch in the locked or OFF position before making any adjustments, changing accessories, or storing the tool.** Such preventive safety measures reduce the risk of starting the tool accidentally.
- 5. Store idle tools out of reach of children and other untrained persons.** Tools are dangerous in the hands of untrained users.
- 6. When battery pack is not in use, keep it away from other metal objects like: paper clips, coins, keys, nails, screws, or other small metal objects that can make a connection from one terminal to another.** Shorting the battery terminals together may cause sparks, burns, or a fire.
- 7. Maintain tools with care. Keep cutting tools sharp and clean.** Properly maintained tools with sharp cutting edge are less likely to bind and are easier to control.
- 8. Check for misalignment or binding of moving parts, breakage of parts, and any other condition that may affect the tool's operation. If damaged, have the tool serviced before using.** Many accidents are caused by poorly maintained tools.
- 9. Use only accessories that are recommended by the manufacturer for your model.** Accessories that may be suitable for one tool may create a risk of injury when used on another tool.

SERVICE

- 1. Tool service must be performed only by qualified repair personnel.** Service or maintenance performed by unqualified personnel may result in a risk of injury.
- 2. When servicing a tool, use only identical replacement parts. Follow instructions in the Maintenance Section of this manual.** Use of unauthorized parts or failure to follow Maintenance Instructions may create a risk of shock or injury.





SPECIFIC SAFETY RULES AND SYMBOLS

- 1. Hold tool by insulated gripping surfaces when performing an operation where the cutting tool may contact hidden wiring.** Contact with a "live" wire will also make exposed metal parts of the tool "live" and shock the operator.
- 2. Be aware** that this tool is always in an operating condition, because it does not have to be plugged into an electrical outlet. Always set the trigger switch to the locked OFF position when installing or removing the battery pack or saw blade.
- 3. Keep blades sharp.**
- 4. Keep hands away from cutting area.** When sawing never reach underneath or behind the material being cut for any reason.
- 5. When you have finished a cut** be careful not to come into contact with the blade. Turn off the motor immediately.
- 6.  WARNING: EXERCISE EXTREME CAUTION WHEN BLIND CUTTING TO BE CERTAIN THAT THERE ARE NO FOREIGN OBJECTS SUCH AS ELECTRICAL WIRE, CONDUIT, PLUMBING PIPES, ETC., THAT MAY COME INTO CONTACT WITH THE BLADE.**

7. Some wood contains preservatives which can be toxic. Take extra care to prevent inhalation and skin contact when working with these materials. Request, and follow, all safety information available from your material supplier.

8. ⚠️ WARNING: There are certain applications for which this tool was designed. Porter-Cable strongly recommends that this tool NOT be modified and/or used for any application other than for which it was designed. If you have any questions relative to its application DO NOT use the tool until you have written Porter-Cable and we have advised you.

Technical Service Manager
 Porter-Cable Corporation
 4825 Highway 45 North
 Jackson, TN 38305

SYMBOL	DEFINITION
V	volts
A	amperes
Hz	hertz
W	watts
PSI	pounds per square inch
Min.	minimum
Max.	maximum
in.	inch
MM	millimeters
h	hours
min	minutes
s	seconds
	alternating current
	direct current
n_0	no load
	alternating or direct current
	Class II Construction
.../min	revolutions or reciprocation per minute

SAFETY INSTRUCTIONS FOR CHARGER AND BATTERIES

- 1. SAVE THESE INSTRUCTIONS.** This manual contains important safety and operating instructions for Porter-Cable Battery Charger.
- 2. Before using a battery charger,** read all instructions and cautionary markings on (1) battery charger, (2) battery pack, and (3) product using battery.
- 3. CAUTION:** To reduce risk of injury, a Porter-Cable charger should only be used to charge a Porter-Cable battery pack. Other types of batteries may burst causing personal injury and damage. Do not charge a Porter-Cable battery pack with any other charger.
- 4. Do not expose charger** to rain, snow or frost.
- 5. Do not abuse cord.** Never carry charger by cord or yank it to disconnect from receptacle. Pull by plug rather than cord when disconnecting charger. Have damaged or worn power cord and strain reliever replaced immediately. DO NOT ATTEMPT TO REPAIR POWER CORD.
- 6. Make sure cord** is located so that it will not be stepped on, tripped over, or otherwise subjected to damage or stress.

7. Do not use an extension cord unless absolutely necessary. Use of improper extension cord could result in a risk of fire and electric shock. If an extension cord must be used, make sure:

- A. That the pins on plug of extension cord are the same number, size and shape as those of plug on charger.
- B. That the extension cord is properly wired and in good electrical condition.
- C. Wire Size of cord is at least as specified in following chart:

LENGTH OF CORD IN FEET	25	50	100	150
AWG SIZE OF CORD	18	18	18	16

D. If an extension cord is to be used outdoors it must be marked with the suffix W-A or W following the cord type designation. For example – SJTW-A to indicate it is acceptable for outdoor use.

8. Do not operate charger with damaged cord or plug – have them replaced immediately, to avoid a hazard. **DO NOT ATTEMPT TO REPAIR POWER CORD.**

9. Do not operate charger if it has received a sharp blow, been dropped, or otherwise damaged in any way; take it to a qualified serviceman.

10. Do not disassemble charger or battery pack. Take it to a qualified serviceman when service or repair is required. Incorrect reassembly may result in a risk of electric shock or fire.

11. Unplug charger from outlet before attempting any maintenance or cleaning – to reduce risk of electric shock.

12. Charge the battery pack in a well ventilated place, do not cover the charger and battery pack with a cloth, etc., while charging.

13. Do not store the charger or battery pack in locations where the temperature may reach or exceed 122°F (50°C) (such as a metal tool shed, or a car in the summer), which can lead to deterioration of the storage battery.

14. Do not charge battery pack when the temperature is BELOW 40°F or ABOVE 104°F (4.4/40°C). This is very important for proper operation.

15. Do not incinerate battery pack. It can explode in a fire.

16. Do not charge battery in damp or wet locations.

17. Do not attempt to charge any other cordless tool or battery pack with the Porter-Cable charger.

18. Do not short across the terminals of the battery pack: **EXTREMELY HIGH TEMPERATURES COULD CAUSE PERSONAL INJURY OR FIRE.**

19. Double insulated tools are equipped with a polarized plug (one blade is wider than the other). This plug will fit in a polarized outlet only one way. If the plug does not fit fully in the outlet, reverse the plug. If it still does not fit, contact a qualified electrician to install a polarized outlet. Do not change the plug in any way. Double Insulation eliminates the need for the three wire grounded power cord and grounded power supply system.

20. Dispose of expended batteries properly. The Porter-Cable Battery Packs contains rechargeable, nickel-cadmium batteries. These batteries must be recycled or disposed of properly. Drop off expended battery packs at your local replacement battery retailer, your local recycling center, or at a Porter-Cable Service Center (see list on back page of this manual). Applicable fees for the collection and recycling of these batteries (in the United States), have been paid to the RBRC™. For further information, call: 1-800-8-BATTERY.



RBRC™ is a Trademark of the Rechargeable Battery Recycling Corporation.

FUNCTIONAL DESCRIPTION

FOREWORD

Porter-Cable Model 643 Cordless Jigsaw is designed for cutting materials of the following MAXIMUM thickness: wood $4\frac{1}{8}$ ", plastic and fiberglass $1\frac{1}{4}$ ", aluminum and nonferrous metals $\frac{13}{16}$ ", mild steel $\frac{3}{8}$ ", and stainless steel $\frac{1}{8}$ ".

ASSEMBLY

ANTI-SPLINTER BASE INSERT INSTALLATION

The anti-splinter base insert is used to reduce chipping and splintering of the top fibers of plywood, paneling, and other splinter prone materials. When this insert is used it is not necessary to have the good or finished side of the work down during the cutting operation.

Install the insert as shown in Fig. 1.

NOTE: When using the anti-splinter insert, the base should be set to the forward most position (Fig. 9).

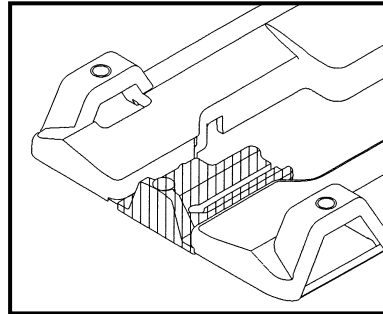

Fig. 1

ANTI-MAR PLASTIC SUB-BASE INSTALLATION

CAUTION: REMOVE BATTERY PACK.

The anti-mar plastic sub-base is used when cutting on finished surfaces to prevent the normal metal base from scratching, gouging, or otherwise marring the surface of the material to be cut.

To install the plastic sub-base, remove the six screws (Fig. 9) from the bottom of the base, remove the metal sub-base, place the plastic sub-base on the saw, and reinstall the six screws. Be sure to save the metal sub-base for reuse.

BLADE INSTALLATION

1. Remove anti-splinter insert if installed.
2. Gently squeeze the switch trigger until the blade shaft moves slowly and stop the motor when the blade shaft is at or near the bottom of its stroke (Fig. 6).

CAUTION: REMOVE BATTERY PACK.

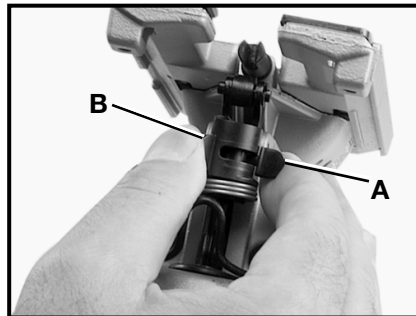

Fig. 2



Fig. 3

3. Open the blade clamp by rotating the movable lever (B), Fig. 2, towards the stationary lever (A), Fig. 2, as far as it will go and hold.

4. While holding the blade clamp open; move lever (A) as far forward as it will go, (see Figs. 2 & 3), and hold.

NOTE: Steps 3 and 4 should be done in one motion.

5. With the teeth of the blade toward the front of the saw, insert the blade through the blade guide into the blade holder as far as it will go and release the levers (Fig. 4).

6. Pull up on the blade (Fig. 3) until it locks in place. The blade is properly installed when the levers are aligned as shown in Fig. 4.

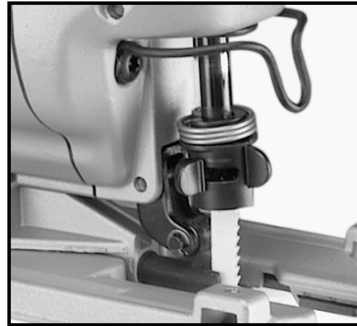

Fig. 4

BLADE REMOVAL

1. Remove the anti-splinter insert if installed.

2. Gently squeeze the switch trigger until the blade shaft moves slowly and stop the motor when the blade shaft is at or near the bottom of its stroke (Fig. 6).

CAUTION: REMOVE BATTERY PACK.

3. Open the blade clamp by rotating the movable lever (B), Fig. 2, towards the stationary lever (A), Fig. 2, as far as it will go.

4. Move the blade shaft forward until the blade is clear of the blade guide.

5. Grasp the tip of the blade, move it towards the blade holder lever/right hand side of saw and pull the blade out of the clamp.

OPERATION

TO START AND STOP SAW

Make sure power circuit voltage is the same as shown on the specification plate on the saw, and that saw switch is OFF. Connect battery pack.

1. Squeeze trigger switch (A), Fig. 5, to start motor. Release trigger to stop motor.

2. Lock-Out Button – A lock-out button (B), Fig. 5, is provided to prevent unintentional starting. To lock the switch trigger “OFF”, push the button to the right.

To UNLOCK the lock-out, push the button to the left.

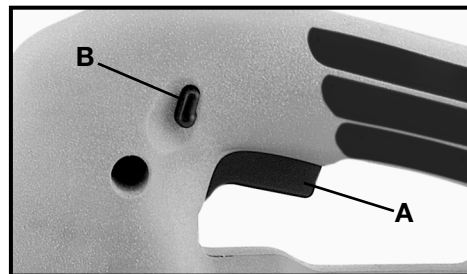

Fig. 5

VARIABLE SPEED

This saw is equipped with a variable speed control switch. The speed range is 0 to 2200 SPM. The speed is adjusted by squeezing the switch trigger. The more the switch trigger is squeezed the higher the speed.

Use higher speed for fast cutting when finish and accuracy are not critical. Use slower speed when accuracy and finish are critical or for delicate materials.

BLADE ORBIT

The blade orbit may be varied by turning knob (A), Fig. 6, to any of four positions indicated by the numbers "0" through "3", with "0" producing no orbit and "3" producing maximum orbit. The orbit may be adjusted with or without the motor running. Move knob (A), Fig. 6, to the detent in the housing corresponding to the number on the housing. The knob is shown in the vertical position "3". The horizontal position would be setting "0". Metal cutting should be performed in orbit setting "0".

Use of higher orbit settings when performing intricate scroll cuts may cause blade breakage. The lower orbit settings are recommended for scrolling. Orbit position "0" will produce the most accurate cuts with less splintering and the longest blade life.

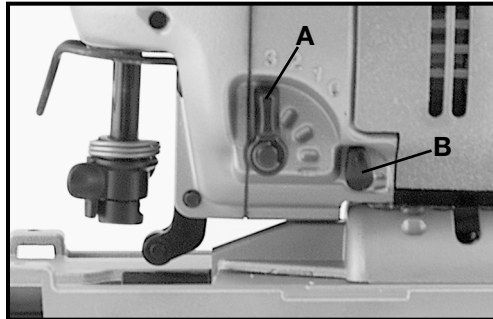

Fig. 6

CHIP BLOWER

This saw is equipped with a chip blower to keep the cutting area free of chips. Use knob (B), Fig. 6, to turn the chip blower on and off. The knob is shown in the "ON" position, to turn the chip blower "OFF" turn the knob clockwise until it stops.

PLUNGE CUTTING

⚠ WARNING: When cutting into a wall avoid contact with all exposed metal on the tool to prevent electrical shock hazard resulting from accidentally cutting into a live wire. HOLD SAW AS ILLUSTRATED IN FIG. 7.



Fig. 7

One of the distinctive and important features of the Porter-Cable jigsaw is the ability to start the cut, (in wood only) within an area, without making drilled holes first. This is especially important when making cutouts for electrical outlets in finished walls, openings in cabinet tops for sinks and openings for plumbing fixtures.

NOTE: When plunge cutting, it is recommended the orbit knob be set to position "3".



Fig. 8

First, measure the area to be cut out and mark it clearly with a pencil, chalk or scribe. Choose a convenient starting point and hold the jigsaw over the point and inside the line of waste. Tip the machine forward until the front edge of the base rests firmly on the surface of the material with the tip of the blade clear of the work surface, as shown in Fig. 8. Turn motor "ON" and slowly lower the back of the machine until the base is fully seated on the surface of the work. Now, guide the cutting along the inside of the marked area. If sharp corners are desired cut right up to the corner of the marked edge. Stop and back up just a bit, start the turn and cut along the side. Do the same at each corner until you end up where you started. Then, go back and cut into each corner from the opposite direction. The base of the machine is wide enough so you will have a solid guiding surface on either side of the cut.

BASE ADJUSTMENT

The base may be adjusted two ways, front to rear and tilted either left or right for making bevel cuts. The base has a detent at the 0 (90 degree) setting and at 15, 30 and 45 degree setting both left and right of center.

The base is set at its forward most position at the factory. The base can be adjusted to the rear for making flush cuts around walls and other similar areas. To move the base forward or backward, turn the saw on its side, loosen screw (A), Fig. 9, move the base to the desired position and retighten the screw.

NOTE: When making bevel cuts, the base should be set to the forward most position (Fig. 9).

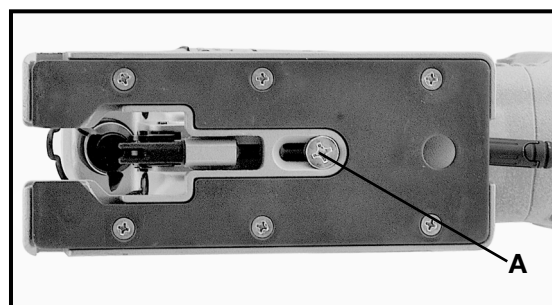

Fig. 9

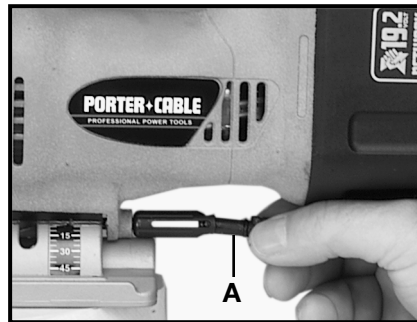

Fig. 10



Fig. 11

To tilt the base, pull the lever out of the end of clamp screw (A), Fig. 10, rotate the lever toward the front of the saw (Fig. 11) and turn the lever counter-clockwise until the base can be tilted. Set the base at the desired setting and tighten the screw by turning the lever clockwise.

NOTE: After each 90 degree or half turn, it will be necessary to move the lever back to the opposite side of the saw.

USING THE SAW

First, secure the material in a bench vise or with clamps to the work table. This is especially important when sawing small pieces or thin material. As the work progresses in scroll or curved cut-out pieces, the material can be readjusted to accommodate the movement of the saw. If the work is large enough it can be held by hand across saw horses. The saw cuts freely with only light forward feed pressure on the tool. Forcing the saw will not make it cut faster.

To start the cut, secure the work, mark the line of cut clearly, place the forward edge of the saw base firmly on the edge of the material, start the motor and move the blade into the work.

DO NOT FORCE, LET THE SAW DO THE WORK. Move the machine forward only rapidly enough to keep the blade cutting.

You will find that the open throat and clear forward edge of the saw base make it easy to follow the line and cut closely to the pattern. You need not cut oversize for hand finishing or sanding on most materials. The smoothness of cut will often make further sanding unnecessary.

BATTERY OPERATION

CHARGING THE BATTERY PACK GENERAL

Before using your cordless tool for the first time, the battery pack should be fully charged. If the battery pack is installed, remove it by following instructions under INSTALLING OR REMOVING BATTERY PACK.

As a battery pack approaches the discharged state, you will notice a sharp drop in tool performance. When the tool is unable to perform the task at hand, it is time to recharge the battery pack. Recharging the battery pack before this condition is reached will reduce the total work life of the pack. Discharging the pack beyond this point can damage the pack.

NOTE: Battery temperature will increase during and shortly after use. Batteries may not accept a full charge if they are charged immediately after use. Allow the battery pack to cool to room temperature before charging for best results.

The battery charger may rest on the four pads provided on the bottom of the case or be mounted on a wall by utilizing the two key hole slots provided.

CAUTION: Vent slots in top and bottom of charger must not be obstructed. Do not charge battery when temperature is BELOW 40°F or ABOVE 104°F (4.4/40°C).

NORMAL CHARGING

Make sure power circuit voltage is the same as that shown on the charger specification plate. Connect charger to power source. The red and green lights will flash once to indicate that power is connected properly and the charger is ready for operation.

Position the battery pack on charger, align rails on battery pack (A) Fig. 13 with four tabs (C) Fig. 12 on charger. Slide battery forward on charger until it stops.

The green light (A) Fig. 12 should begin to flash rapidly indicating that the battery pack is receiving a "fast charge". (If the green light does not flash or if the red light (B) illuminates, see DIAGNOSTICS"). After approximately one hour, the "Fast Charge" indicator light should glow continually, indicating that the battery pack is fully charged and that the charger is now in a "Maintenance Charge" mode. The battery pack can be left on "Maintenance Charge" until you are ready to use it.

Depending on room temperature, line voltage, and existing charge level, initial battery charging may take longer than one hour.

Disconnect charger from power source when not in use.

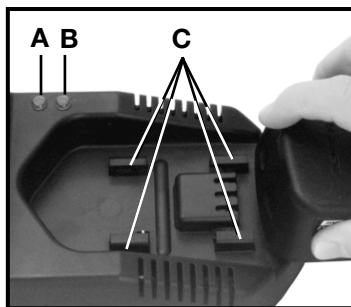

Fig. 12

DIAGNOSTICS

The charger is equipped with a diagnostic system that automatically checks the battery pack each time a pack is inserted into the charger.

If no problems are found, the charger will automatically switch to “Fast Charge” mode as described in NORMAL CHARGING. If a problem is found, it will be indicated by the charger indicator lights (see Fig. 12), as follows:

- If the green light (A) flashes slowly after battery pack is inserted in charger, the battery pack temperature is either too high or too low for charging. If left alone, the charger will continue to monitor the battery pack temperature and will begin charging when the temperature reaches an acceptable level.
- If the red light (B) flashes continuously, the battery pack has failed (pack is not chargeable and requires replacement).

INSTALLING OR REMOVING BATTERY PACK

⚠ WARNING: Always set the trigger switch to the locked OFF position when installing or removing the battery pack.

TO REMOVE BATTERY PACK: Depress the battery release button (B) Fig. 13, and pull battery pack out of tool.

TO INSTALL BATTERY PACK: Align rails (A) Fig. 13, on battery pack with slots on tool and push battery pack onto tool until it locks in place.



Fig. 13

MAINTENANCE

KEEP TOOL CLEAN

All plastic parts should be cleaned with a soft damp cloth. NEVER use solvents to clean plastic parts. They could very possibly dissolve or otherwise damage the material.

FAILURE TO START

Should your tool fail to start, make sure battery pack is charged and properly installed in drill.

BATTERY

The battery pack will discharge by itself without damage if stored for long periods of time, and may require recharging before use.

LUBRICATION

For your continued safety and electrical protection, lubrication and service on this tool should ONLY be performed by an AUTHORIZED PORTER-CABLE SERVICE STATION or a PORTER-CABLE/DELTA FACTORY SERVICE CENTER.

At approximately 100 hours of use, take or send your tool to your nearest Authorized Porter-Cable Service Station to be thoroughly cleaned and inspected; worn parts replaced, when necessary; relubricated with fresh lubricant, and performance tested.

SERVICE AND REPAIRS

All quality tools will eventually require servicing or replacement of parts due to wear from normal use. These operations, including brush inspection and replacement, should ONLY be performed by either an AUTHORIZED PORTER-CABLE SERVICE STATION or a PORTER-CABLE/DELTA FACTORY SERVICE CENTER. All repairs made by these agencies are fully guaranteed against defective material and workmanship. We cannot guarantee repairs made or attempted by anyone other than these agencies.

Should you have any questions about your tool, feel free to write us at any time. In any communications, please give all information shown on the nameplate of your tool (model number, type, serial number, etc.).

ACCESSORIES

A complete line of accessories is available from your Porter-Cable • Delta Supplier, Porter-Cable • Delta Factory Service Centers, and Porter-Cable Authorized Service Stations. Please visit our Web Site www.porter-cable.com for a catalog or for the name of your nearest supplier.

⚠ WARNING: Since accessories other than those offered by Porter-Cable • Delta, have not been tested with this product use of such accessories could be hazardous. For safest operation, only Porter-Cable • Delta recommended accessories should be used with this product.

PORTER-CABLE LIMITED ONE YEAR WARRANTY

Porter-Cable warrants its Professional Power Tools for a period of one year from the date of original purchase. We will repair or replace at our option, any part or parts of the product and accessories covered under this warranty which, after examination, proves to be defective in workmanship or material during the warranty period. For repair or replacement return the complete tool or accessory, transportation prepaid, to your nearest Porter-Cable Service Center or Authorized Service Station. Proof of purchase may be required. This warranty does not apply to repair or replacement required due to misuse, abuse, normal wear and tear or repairs attempted or made by other than our Service Centers or Authorized Service Stations.

ANY IMPLIED WARRANTY, INCLUDING THE IMPLIED WARRANTIES OF MERCHANTABILITY AND FITNESS FOR A PARTICULAR PURPOSE, WILL LAST ONLY FOR ONE (1) YEAR FROM THE DATE OF PURCHASE.

To obtain information on warranty performance please write to: PORTER-CABLE CORPORATION, 4825 Highway 45 North, Jackson, Tennessee 38305; Attention: Product Service. THE FOREGOING OBLIGATION IS PORTER-CABLE'S SOLE LIABILITY UNDER THIS OR ANY IMPLIED WARRANTY AND UNDER NO CIRCUMSTANCES SHALL PORTER-CABLE BE LIABLE FOR ANY INCIDENTAL OR CONSEQUENTIAL DAMAGES. Some states do not allow limitations on how long an implied warranty lasts or the exclusion or limitation of incidental or consequential damages, so the above limitation or exclusion may not apply to you.

This warranty gives you specific legal rights and you may also have other legal rights which vary from state to state.

**PORTER-CABLE • DELTA SERVICE CENTERS
(CENTROS DE SERVICIO DE PORTER-CABLE • DELTA)
(CENTRE DE SERVICE PORTER-CABLE • DELTA)**

**Parts and Repair Service for Porter-Cable • Delta Power Tools are Available at These Locations
(Obtenga Refacción de Partes o Servicio para su Herramienta en los Sigüientes Centros de Porter-Cable • Delta)
(Locations où vous trouverez les pièces de rechange nécessaires ainsi qu'un service d'entretien)**

ARIZONA Tempe 85282 (Phoenix) 2400 West Southern Avenue Suite 105 Phone: (602) 437-1200 Fax: (602) 437-2200	ILLINOIS Addison 60101 (Chicago) 400 South Rohlwing Rd. Phone: (630) 424-8805 Fax: (630) 424-8895	MINNESOTA Cleveland 44125 8001 Sweet Valley Drive Unit #19 Phone: (216) 447-9030 Fax: (216) 447-3097	CALIFORNIA Ontario 91761 (Los Angeles) 3949A East Guasti Road Phone: (909) 390-5555 Fax: (909) 390-5554	Woodridge 60517 (Chicago) 2033 West 75th Street Phone: (630) 910-9200 Fax: (630) 910-0360	MISSOURI North Kansas City 64116 1141 Swift Avenue Phone: (816) 221-2070 Fax: (816) 221-2897	OREGON Portland 97230 4916 NE 122 nd Ave. Phone: (503) 252-0107 Fax: (503) 252-2123	MARYLAND San Leandro 94577 (Oakland) 3039 Teagarden Street Phone: (510) 357-9762 Fax: (510) 357-7939	MARYLAND Elkridge 21075 (Baltimore) 7397-102 Washington Blvd. Phone: (410) 799-9394 Fax: (410) 799-9398	St. Louis 63119 7574 Watson Road Phone: (314) 968-8950 Fax: (314) 968-2790	PENNSYLVANIA Willow Grove 19090 520 North York Road Phone: (215) 658-1430 Fax: (215) 658-1433	COLORADO Arvada 80003 (Denver) 8175 Sheridan Blvd., Unit S Phone: (303) 487-1809 Fax: (303) 487-1868	MASSACHUSETTS Braintree 02185 (Boston) 719 Granite Street Phone: (781) 848-9810 Fax: (781) 848-6759	NEW YORK Flushing 11365-1595 (N.Y.C.) 175-25 Horace Harding Expwy. Phone: (718) 225-2040 Fax: (718) 423-9619	FLORIDA Davie 33314 (Miami) 4343 South State Rd. 7 (441) Unit #107 Phone: (954) 321-6635 Fax: (954) 321-6638	Franklin 02038 (Boston) Franklin Industrial Park 101E Constitution Blvd. Phone: (508) 520-8802 Fax: (508) 528-8089	NORTH CAROLINA Charlotte 28270 9129 Monroe Road, Suite 115 Phone: (704) 841-1176 Fax: (704) 708-4625	TEXAS Carrollton 75006 (Dallas) 1300 Interstate 35 N, Suite 112 Phone: (972) 446-2996 Fax: (972) 446-8157	GEORGIA Forest Park 30297 (Atlanta) 5442 Frontage Road, Suite 112 Phone: (404) 608-0006 Fax: (404) 608-1123	MICHIGAN Madison Heights 48071 (Detroit) 30475 Stephenson Highway Phone: (248) 597-5000 Fax: (248) 597-5004	OHIO Columbus 43214 4560 Indianola Avenue Phone: (614) 263-0929 Fax: (614) 263-1238	Houston 77055 West 10 Business Center 1008 Wirt Road, Suite 120 Phone: (713) 682-0334 Fax: (713) 682-4867	WASHINGTON Auburn 98001 (Seattle) 3320 West Valley HWY, North Building D, Suite 111 Phone: (253) 333-8353 Fax: (253) 333-9613
---	--	--	--	--	---	--	---	--	---	--	---	--	---	--	--	---	--	---	--	--	---	---

Authorized Service Stations are located in many large cities. Telephone **800-487-8665** or **731-541-6042** for assistance locating one. Parts and accessories for Porter-Cable • Delta products should be obtained by contacting any Porter-Cable • Delta Distributor, Authorized Service Center, or Porter-Cable • Delta Factory Service Center. If you do not have access to any of these, call **888-848-5175** and you will be directed to the nearest Porter-Cable • Delta Factory Service Center. Las Estaciones de Servicio Autorizadas están ubicadas en muchas grandes ciudades. Llame al **800-487-8665** ó al **731-541-6042** para obtener asistencia a fin de localizar una. Las piezas y los accesorios para los productos Porter-Cable • Delta deben obtenerse poniéndose en contacto con cualquier distribuidor Porter-Cable • Delta, Centro de Servicio Autorizado o Centro de Servicio de Fábrica Porter-Cable • Delta. Si no tiene acceso a ninguna de estas opciones, llame al **888-848-5175** y le dirigirán al Centro de Servicio de Fábrica Porter-Cable • Delta más cercano. Des centres de service agréés sont situés dans beaucoup de grandes villes. Appelez au **800-487-8665** ou au **731-541-6042** pour obtenir de l'aide pour en repérer un. Pour obtenir des pièces et accessoires pour les produits Porter-Cable • Delta, s'adresser à tout distributeur Porter-Cable • Delta, centre de service agréé ou centre de service d'usine Porter-Cable • Delta. Si vous n'avez accès à aucun de ces centres, appelez le **888-848-5175** et on vous dirigera vers le centre de service d'usine Porter-Cable • Delta le plus proche.

CANADIAN PORTER-CABLE • DELTA SERVICE CENTERS

ALBERTA Bay 6, 2520-23rd St. N.E. Calgary, Alberta T2E 8L2 Phone: (403) 735-6166 Fax: (403) 735-6144	MANITOBA 1699 Dublin Avenue Winnipeg, Manitoba R3H 0H2 Phone: (204) 633-9259 Fax: (204) 632-1976	QUÉBEC 1515 Ave. St-Jean Baptiste, Québec, Québec G2E 5E2 Phone: (418) 877-7112 Fax: (418) 877-7123
BRITISH COLUMBIA 8520 Baxter Place Burnaby, B.C. V5A 4T8 Phone: (604) 420-0102 Fax: (604) 420-3522	ONTARIO 505 Southgate Drive Guelph, Ontario N1H 6M7 Phone: (519) 836-2840 Fax: (519) 767-4131	1447, Begin St-Laurent, (Montréal), Québec H4R 1V8 Phone: (514) 336-8772 Fax: (514) 336-3505

The following are trademarks of PORTER-CABLE • DELTA (Las siguientes son marcas registradas de PORTER-CABLE • DELTA S.A.) (Les marques suivantes sont des marques de fabricant de la PORTER-CABLE • DELTA): Auto-Set®, BAMMER®, B.O.S.S.®, Builder's Saw®, Contractor's Saw II™, Delta®, DELTACRAFT®, DELTAGRAM™, Delta Series 2000™, DURATRONIC™, Erc™, FLEX®, Flying Chips™, FRAME SAW®, Homecraft®, INNOVATION THAT WORKS®, Jet-Lock®, JETSTREAM®, 'kickstand', LASERLOC®, MICRO-SET®, Micro-Set®, MIDI LATHE®, MORTEN™, NETWORK™, OMNIJIG®, POCKET CUTTER®, PORTA-BAND®, PORTA-PLANE®, PORTER-CABLE® & (design), PORTER-CABLE® PROFESSIONAL POWER TOOLS, Posi-Matic®, Q-3® & (design), QUICKSAND® & (design), QUICKSET™, QUICKSET II®, QUICKSET PLUS™, RIPTIDE™ & (design), SAFE GUARD II®, SAFE-LOC®, Sanding Center®, SANDTRAP® & (design), SAW BOSS®, Sawbuck™, Sidekick®, SPEED-BLOC®, SPEEDMATIC®, SPEEDTRONIC®, STAIR EASE®, The American Woodshop® & (design), The Lumber Company® & (design), THE PROFESSIONAL EDGE®, THE PROFESSIONAL SELECT®, THIN-LINE™, TIGER®, TIGER CUB®, TIGER SAW®, TORQBUSTER®, TORQ-BUSTER®, TRU-MATCH™, TWIN-LITE®, UNIGUARD®, Unifence®, UNIFEEDER™, Unihead®, Uniplane™, Unirip®, Unisaw®, Univise®, Versa-Feeder®, VERSA-PLANE®, WHISPER SERIES®, WOODWORKER'S CHOICE™.

Trademarks noted with ™ and ® are registered in the United States Patent and Trademark Office and may also be registered in other countries. Las Marcas Registradas con el signo de ™ y ® son registradas por la Oficina de Registros y Patentes de los Estados Unidos y también pueden estar registradas en otros países. Marques déposées, indiquées par la lettre ™ et ®, sont déposées au Bureau des brevets d'invention et marques déposées aux Etats-Unis et pourraient être déposées aux autres pays.

Printed in U.S.A.

Free Manuals Download Website

<http://myh66.com>

<http://usermanuals.us>

<http://www.somanuals.com>

<http://www.4manuals.cc>

<http://www.manual-lib.com>

<http://www.404manual.com>

<http://www.luxmanual.com>

<http://aubethermostatmanual.com>

Golf course search by state

<http://golfingnear.com>

Email search by domain

<http://emailbydomain.com>

Auto manuals search

<http://auto.somanuals.com>

TV manuals search

<http://tv.somanuals.com>