

Instruction manual

Double Insulated 1/2" Right Angle Drill



MODEL 7556

To learn more about Porter-Cable
visit our website at:

<http://www.porter-cable.com>

PORTER-CABLE
PROFESSIONAL POWER TOOLS

IMPORTANT

Please make certain that the person who is to use this equipment carefully reads and understands these instructions before starting operations.

The Model and Serial No. plate is located on the main housing of the tool. Record these numbers in the spaces below and retain for future reference.

Model No. _____

Type _____

Serial No. _____

TABLE OF CONTENTS

IMPORTANT SAFETY INSTRUCTIONS	2
SAFETY GUIDELINES	3
TOOL WARNING LABEL	3
GENERAL SAFETY RULES	4
ADDITIONAL SPECIFIC SAFETY RULES	6
FUNCTIONAL DESCRIPTION	8
CARTON CONTENTS	9
ASSEMBLY	9
OPERATION	10
TROUBLESHOOTING	13
MAINTENANCE	14
SERVICE	15
ACCESSORIES	15
WARRANTY	16
ESPAÑOL	17
FRANÇAISE	31
SERVICE CENTER LOCATIONS	back cover

IMPORTANT SAFETY INSTRUCTIONS

⚠ WARNING Read and understand all warnings and operating instructions before using any tool or equipment. When using tools or equipment, basic safety precautions should always be followed to reduce the risk of personal injury. Improper operation, maintenance or modification of tools or equipment could result in serious injury and property damage. There are certain applications for which tools and equipment are designed. Porter-Cable strongly recommends that this product NOT be modified and/or used for any application other than for which it was designed.

If you have any questions relative to its application DO NOT use the product until you have written Porter-Cable and we have advised you.

Online contact form at www.porter-cable.com

Postal Mail: Technical Service Manager
Porter-Cable Corporation
4825 Highway 45 North
Jackson, TN 38305

Information regarding the safe and proper operation of this tool is available from the following sources:

Power Tool Institute
1300 Sumner Avenue, Cleveland, OH 44115-2851
www.powertoolinstitute.org

National Safety Council
1121 Spring Lake Drive, Itasca, IL 60143-3201

American National Standards Institute, 25 West 43rd Street, 4 floor, New York, NY 10036 www.ansi.org ANSI 01.1 Safety Requirements for Woodworking Machines, and the U.S. Department of Labor regulations www.osha.gov

SAVE THESE INSTRUCTIONS!

SAFETY GUIDELINES - DEFINITIONS

It is important for you to read and understand this manual. The information it contains relates to protecting YOUR SAFETY and PREVENTING PROBLEMS. The symbols below are used to help you recognize this information.

⚠ DANGER

indicates an imminently hazardous situation which, if not avoided, will result in death or serious injury.

⚠ WARNING

indicates a potentially hazardous situation which, if not avoided, could result in death or serious injury.

⚠ CAUTION

indicates a potentially hazardous situation which, if not avoided, may result in minor or moderate injury.

CAUTION

used without the safety alert symbol indicates a potentially hazardous situation which, if not avoided, may result in property damage.

CALIFORNIA PROPOSITION 65

⚠ WARNING Some dust created by power sanding, sawing, grinding, drilling, and other construction activities contains chemicals known (to the State of California) to cause cancer, birth defects or other reproductive harm. Some examples of these chemicals are:

- lead from lead-based paints
- crystalline silica from bricks and cement and other masonry products
- arsenic and chromium from chemically-treated lumber

Your risk from these exposures varies, depending on how often you do this type of work. To reduce your exposure to these chemicals: work in a well ventilated area, and work with approved safety equipment, always wear MSHA/NIOSH approved, properly fitting face mask or respirator when using such tools.

GENERAL SAFETY RULES*

▲WARNING

Read all instructions. Failure to follow all instructions listed below may result in electric shock, fire and/or serious injury. The term "power tool" in all of the warnings listed below refers to your mains-operated (corded) power tool or battery-operated (cordless) power tool.



SAVE THESE INSTRUCTIONS

1) Work area safety

- a) **Keep work area clean and well lit.** Cluttered or dark areas invite accidents.
- b) **Do not operate power tools in explosive atmospheres, such as in the presence of flammable liquids, gases or dust.** Power tools create sparks which may ignite the dust or fumes.
- c) **Keep children and bystanders away while operating a power tool.** Distractions can cause you to lose control.

2) Electrical safety

- a) **Power tool plugs must match the outlet. Never modify the plug in any way. Do not use any adapter plugs with earthed (grounded) power tools.** Unmodified plugs and matching outlets will reduce risk of electric shock.
- b) **Avoid body contact with earthed or grounded surfaces such as pipes, radiators, ranges and refrigerators.** There is an increased risk of electric shock if your body is earthed or grounded.
- c) **Do not expose power tools to rain or wet conditions.** Water entering a power tool will increase the risk of electric shock.
- d) **Do not abuse the cord. Never use the cord for carrying, pulling or unplugging the power tool. Keep cord away from heat, oil, sharp edges or moving parts.** Damaged or entangled cords increase the risk of electric shock.
- e) **When operating a power tool outdoors, use an extension cord suitable for outdoor use.** Use of a cord suitable for outdoor use reduces the risk of electric shock.

3) Personal safety

- a) **Stay alert, watch what you are doing and use common sense when operating a power tool. Do not use a power tool while you are tired or under the influence of drugs, alcohol or medication.** A moment of inattention while operating power tools may result in serious personal injury.
- b) **Use safety equipment. Always wear eye protection.** Safety equipment such as dust mask, non-skid safety shoes, hard hat, or hearing protection used for appropriate conditions will reduce personal injuries.
- c) **Avoid accidental starting. Ensure the switch is in the off-position before plugging in.** Carrying power tools with your finger on the switch or plugging in power tools that have the switch on invites accidents.

GENERAL SAFETY RULES* continued

- d) **Remove any adjusting key or wrench before turning the power tool on.** A wrench or a key left attached to a rotating part of the power tool may result in personal injury.
- e) **Do not overreach. Keep proper footing and balance at all times.** This enables better control of the power tool in unexpected situations.
- f) **Dress properly. Do not wear loose clothing or jewellery. Keep your hair, clothing and gloves away from moving parts.** Loose clothes, jewellery or long hair can be caught in moving parts.
- g) **If devices are provided for the connection of dust extraction and collection facilities, ensure these are connected and properly used.** Use of these devices can reduce dust-related hazards.

4) Power tool use and care

- a) **Do not force the power tool. Use the correct power tool for your application.** The correct power tool will do the job better and safer at the rate for which it was designed.
- b) **Do not use the power tool if the switch does not turn it on and off.** Any power tool that cannot be controlled with the switch is dangerous and must be repaired.
- c) **Disconnect the plug from the power source before making any adjustments, changing accessories, or storing power tools.** Such preventive safety measures reduce the risk of starting the power tool accidentally.
- d) **Store idle power tools out of the reach of children and do not allow persons unfamiliar with the power tool or these instructions to operate the power tool.** Power tools are dangerous in the hands of untrained users.
- e) **Maintain power tools. Check for misalignment or binding of moving parts, breakage of parts and any other condition that may affect the power tools operation. If damaged, have the power tool repaired before use.** Many accidents are caused by poorly maintained power tools.
- f) **Keep cutting tools sharp and clean.** Properly maintained cutting tools with sharp cutting edges are less likely to bind and are easier to control.
- g) **Use the power tool, accessories and tool bits etc., in accordance with these instructions and in the manner intended for the particular type of power tool, taking into account the working conditions and the work to be performed.** Use of the power tool for operations different from those intended could result in a hazardous situation.











5) Service

- a) **Have your power tool serviced by a qualified repair person using only identical replacement parts.** This will ensure that the safety of the power tool is maintained.

ADDITIONAL SPECIFIC SAFETY RULES

1. **USE AUXILIARY HANDLES SUPPLIED WITH THE TOOL.** Loss of control can cause personal injury.
2. **HOLD POWER TOOLS BY INSULATED GRIPPING SURFACES WHEN PERFORMING AN OPERATION WHERE THE CUTTING TOOL MAY CONTACT HIDDEN WIRING OR ITS OWN CORD.** Contact with a "live" wire will make exposed metal parts of the tool "live" and shock the operator.
3. **VERIFY** the direction of rotation before starting the tool.
4. **NEVER ATTEMPT TO CHANGE DIRECTION** of rotation while switch is "ON". To do so, may damage the drill. Be sure switch is "OFF" and motor has completely stopped before changing direction of rotation.
5. **SOME WOOD CONTAINS PRESERVATIVES WHICH CAN BE TOXIC.** Take extra care to prevent inhalation and skin contact when working with these materials. Request, and follow, any safety information available from your material supplier.
6. **DO NOT** use bits larger than those recommended in Fig. A. They increase the chance of jamming. Large bits may also overload the drill and damage the motor and gears.
7. **USE ONLY** the proper chuck key to tighten or loosen the chuck. Do not use chuck if jaws or other parts are cracked or worn.
8. **NEVER** hold work in your hand, lap, or against other parts of your body when drilling.
9. **DO NOT** use drill as a router or try to elongate or enlarge holes by twisting the drill. Drill bits may break and cause injury.
10. **⚠ WARNING** There are certain applications for which this tool was designed. Porter-Cable strongly recommends that this tool NOT be modified and/or used for any application other than for which it was designed. If you have any questions relative to its application DO NOT use the tool until you have written Porter-Cable and we have advised you.

Technical Service Manager
Porter-Cable Corporation
4825 Highway 45 North
Jackson, TN 38305

SYMBOL	DEFINITION
V	volts
A	amperes
Hz	hertz
W	watts
kW	kilowatts
F	farads
μF	microfarads
l	litres
g	grams
kg	kilograms
bar	bars
Pa	pascals
h	hours
min	minutes
s	seconds
n_0	no-load speed
.../min or ...min ⁻¹	Revolutions or reciprocations per minute
 or d.c.	direct current
 or a.c.	alternating current
2 	two-phase alternating current
2N 	two-phase alternating current with neutral
3 	three-phase alternating current
3N 	three-phase alternating current with neutral
 A	rated current of the appropriate fuse-link in amperes
	time-lag miniature fuse-link where X is the symbol for the time/current characteristic, as given in IEC 60127
	protective earth
	class II tool
IPXX	IP symbol

MOTOR

Many Porter-Cable tools will operate on either D.C., or single phase 25 to 60 cycle A.C. current and voltage within plus or minus 5 percent of that shown on the specification plate on the tool. Several models, however, are designed for A.C. current only. Refer to the specification plate on your tool for proper voltage and current rating.

CAUTION

Do not operate your tool on a current on which the voltage is not within correct limits. Do not operate tools rated A.C. only on D.C. current. To do so may seriously damage the tool.

EXTENSION CORD SELECTION

If an extension cord is used, make sure the conductor size is large enough to prevent excessive voltage drop which will cause loss of power and possible motor damage. A table of recommended extension cord sizes will be found in this section. This table is based on limiting line voltage drop to 5 volts (10 volts for 230 volts) at 150% of rated amperes.

If an extension cord is to be used outdoors it must be marked with the suffix W-A or W following the cord type designation. For example – SJTW-A to indicate it is acceptable for outdoor use.

RECOMMENDED EXTENSION CORD SIZES FOR USE WITH PORTABLE ELECTRIC TOOLS

		Length of Cord in Feet									
		115V	25 Ft.	50 Ft.	100 Ft.	150 Ft.	200 Ft.	250 Ft.	300 Ft.	400 Ft.	500 Ft.
		230V	50 Ft.	100 Ft.	200 Ft.	300 Ft.	400 Ft.	500 Ft.	600 Ft.	800 Ft.	1000 Ft.
Nameplate Ampere Rating	0-2	18	18	18	16	16	16	14	14	12	12
	2-3	18	18	16	14	14	12	12	10	10	10
	3-4	18	18	16	14	12	12	10	10	8	8
	4-5	18	18	14	12	12	10	10	8	8	8
	5-6	18	16	14	12	10	10	8	8	6	6
	6-8	18	16	12	10	10	8	6	6	6	6
	8-10	18	14	12	10	8	8	6	6	4	4
	10-12	16	14	10	8	8	6	6	4	4	4
	12-14	16	12	10	8	6	6	6	4	2	2
	14-16	16	12	10	8	6	6	4	4	2	2
	16-18	14	12	8	8	6	4	4	2	2	2
	18-20	14	12	8	6	6	4	4	2	2	2

FUNCTIONAL DESCRIPTION

FOREWORD

Porter-Cable drills are designed to drill holes of various sizes in wood and metal as indicated in the following chart:

Model No. of Drill	Type of Bit	Max. Dia. Hole	Material	
7556	Low Speed	Twist Drill	1/2"	Steel
		Auger Bit	1 3/4"	Wood
		Self Feed Bit	4 5/8"	Wood
	High Speed	Twist Drill	1/2"	Steel
		Auger Bit	1 1/2"	Wood
		Self Feed Bit	2 9/16"	Wood

Fig. A

CARTON CONTENTS

- * Right angle drill
- * Side handle
- * Chuck key
- * Open end wrench
- * Pin wrench

ASSEMBLY

INSTALLING AND REMOVING DRILL BIT

1. **⚠ CAUTION** DISCONNECT TOOL FROM POWER SOURCE.
2. The three-jaw chuck is designed for self-centering of the drill bit. Open chuck jaws by turning outer sleeve counterclockwise, when viewing the chuck from the bit end. Open large enough so that bit shank can be inserted.
3. Clean and insert smooth end of drill bit as far as it will go into the chuck, then withdraw bit approximately $\frac{1}{16}$ ", or up to the flutes for small bits.
4. While holding the bit with one hand, turn outer sleeve clockwise until bit is gripped in the chuck.
5. Tighten chuck – insert chuck key into each of 3 keyholes in chuck body (Fig. 1) in succession and tighten securely by turning key clockwise.
6. **⚠ CAUTION** Be sure chuck key is removed before starting tool.
7. To remove bit, reverse this procedure.

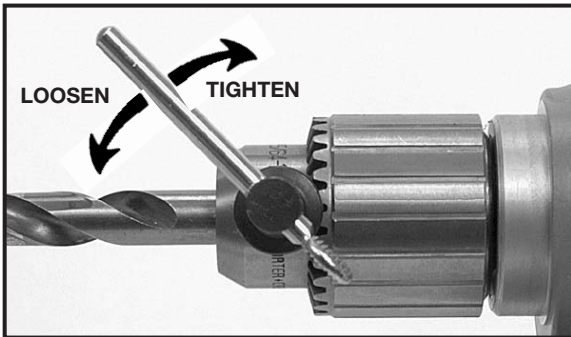

Fig. 1

TO INSTALL AUXILIARY HANDLE

An auxiliary handle (C) Fig. 2, is supplied and can be installed on either side of the tool. This handle screws directly into the drill housing providing complete control of the drill.

It is strongly recommended that the auxiliary handle be used and tool held as illustrated in Fig. 3A during all drilling operations.

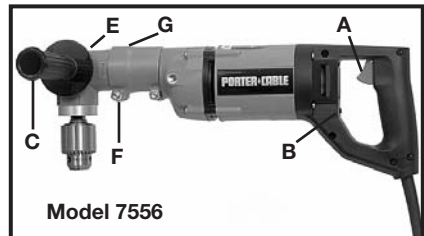

Fig. 2

OPERATION

TO START AND STOP DRILL

1. Make sure drill switch is "OFF". Make sure power circuit voltage is the same as that shown on the specification plate of the drill. Connect drill to power circuit.
2. Squeeze TRIGGER SWITCH (A) Fig. 2, to start motor. As trigger is squeezed, the drill speed increases. Release trigger to stop motor.
3. A REVERSING SWITCH (B) Fig. 2 – is provided with either model. These models will operate in either the forward direction (clockwise rotation) for drilling holes, or the reverse direction (counterclockwise rotation) for releasing jammed drill bits. For counterclockwise rotation, stop the motor by releasing the trigger switch and move the reversing switch to the position labeled "R", or in the opposite direction for clockwise rotation.

NOTE: Never attempt to change direction of rotation while switch is "ON". To do so, may damage the drill. Be sure switch is "OFF" and motor has completely stopped before changing direction of rotation.

TO INCREASE RPMs

The 7556 is factory assembled with the chuck on drive end marked "LOW" and will run at the lower RPM shown on the specification plate. To change to the higher RPM marked on the nameplate proceed as follows:

1. **⚠ CAUTION** DISCONNECT TOOL FROM POWER SOURCE.
2. Open chuck jaws as wide as possible to gain access to chuck retaining screw.
3. Place spindle wrench (furnished with drill) on flats of spindle shaft and hold. With a $\frac{3}{16}$ " hex wrench, turn the retaining screw clockwise (left hand threads) and remove screw from chuck.
4. While supporting chuck on a solid surface, place wrench on flats of spindle and allow the opposite end of wrench to rest on the workbench to your left as shown in Fig. 3. Place chuck pin wrench into chuck key hole so that pin wrench extends to your left as shown in Fig. 3. Strike the pin wrench a sharp blow with a hammer to loosen chuck.
5. Turn chuck counterclockwise to unscrew. Remove chuck and two washers from spindle.
6. Loosen the outer sleeve screw (F) Fig. 2 with a $\frac{1}{2}$ " wrench, and remove the right angle drive (E) Fig. 2, from the sleeve (G) Fig. 2.
7. Place end of right angle drive marked "LOW" into sleeve (G) Fig. 2. Make sure the flats on the driveshaft engage slot in coupling. Tighten sleeve screw (F) Fig. 2.
8. Place steel washer and then brass washer (washers removed in Step 5) onto spindle at end of right angle drive marked "HIGH."

NOTE: Failure to use these washers may cause chuck to seize on spindle.

9. Thread chuck onto spindle and seat firmly by reversing procedure in Step 4.
10. Replace and tighten chuck retaining screw securely.

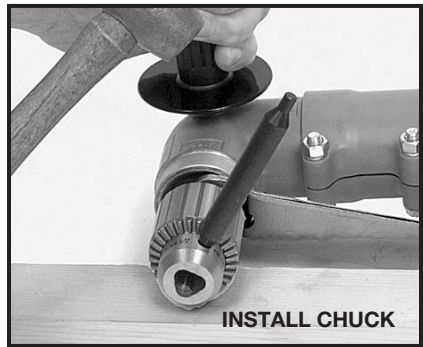
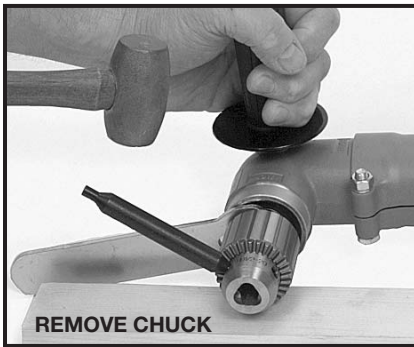

Fig. 3

The 7556 may be converted to a conventional straight drive drill by loosening the back sleeve screw and removing the sleeve and right angle drive from the drill. Remove the coupling retaining screw (hold spindle with spindle wrench, turn screw clockwise with a $\frac{5}{32}$ " hex wrench) and coupling. Remove the chuck and washers from the right angle drive and assemble to drill spindle.

NOTE: Chuck must be firmly seated on spindle before installing chuck retaining screw.

HOW TO HOLD THE DRILL

⚠ WARNING The front end of drill may be made live if the tool drills into live wiring in a wall. **TO PREVENT ACCIDENTAL ELECTRICAL SHOCK, DRILL MUST BE HELD AS SHOWN IN FIG. 3A.**

An auxiliary handle (C) Fig. 2, is supplied with each drill.

GENERAL DRILLING

1. Be sure drill bit is securely gripped in chuck. (See INSTALLING AND REMOVING DRILL BIT).
2. Set REVERSING SWITCH (B) Fig. 2 for clockwise rotation.
3. Make sure work is held securely in vise or clamped in place prior to starting drilling operation.

⚠ CAUTION Loose work may spin and cause bodily injury.

4. Locate exact center for hole to be drilled and using a center punch, make a small dent in work.
5. Place tip of drill bit in dent made by center punch, hold drill square with work, and start the motor.
6. Apply steady, even pressure to keep drill bit cutting. Too little pressure will keep the bit from cutting and dull the edges due to excessive friction created by sliding over the surface.

⚠ CAUTION Too much pressure may cause the bit to break or overheat resulting in bodily injury or damaged drill bits.

RIGHT ANGLE DRILL Model 7556

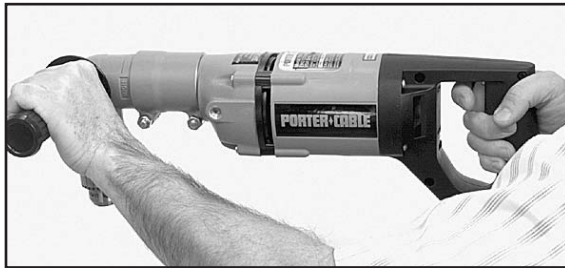

Fig. 3A

⚠ CAUTION BE ALERT and brace yourself against the twisting action of the drill, should bit jam in the work.

7. If drill stalls or becomes jammed in the hole, release trigger immediately, remove drill bit from work and determine cause of stalling or jamming. DO NOT SQUEEZE TRIGGER ON AND OFF IN AN ATTEMPT TO FREE A STALLED OR JAMMED DRILL – THIS WILL DAMAGE THE MOTOR. The direction of rotation may be reversed to help free a jammed bit. Be sure direction of rotation is RESET before attempting to continue drilling.
8. Reduce the pressure on the drill just before the bit cuts through the work to avoid splintering wood or stalling in metal.
9. When bit has completely penetrated work and is spinning freely, withdraw it from the work while the motor is still running, then turn off drill.

DRILLING WOOD

⚠ WARNING SOME WOOD CONTAINS PRESERVATIVES WHICH CAN BE TOXIC. Take extra care to prevent inhalation and skin contact when working with these materials. Request, and follow, any safety information available from your material supplier.

In addition to the instructions listed under GENERAL DRILLING, the following also apply:

1. When using twist drills in wood, they should be withdrawn from the hole frequently to clear chips built up in flutes to avoid overheating and burning work.
2. If a backing block is used to keep back of work from splintering, it should be clamped securely in place. If a backing block is not used with spade bits or auger bits, ease up pressure as soon as bit point breaks through work, and complete the hole from the opposite side.

DRILLING METAL

In addition to the instructions listed under GENERAL DRILLING, the following also apply:

⚠ CAUTION When drilling metal, jamming of bit is more likely than when drilling other materials.

1. Use only good quality sharp high speed steel twist bits when drilling metal.

2. Start drilling with slow speed and gradually increase speed as drill cuts. The harder the material, the slower the speed required. The softer the material, the faster the speed.
3. When drilling a large hole, it is easier to first drill a smaller hole and then enlarge it to the required size.
4. The use of a lubricant, such as oil, on the drill point helps keep the bit cool, increases drilling action and prolongs drill bit life.

TROUBLESHOOTING GUIDE

For assistance with your tool, visit our website at www.porter-cable.com for a list of service centers or call the Porter-Cable help line at 1-800-487-8665.

MAINTENANCE

KEEP TOOL CLEAN

Periodically blow out all air passages with dry compressed air. All plastic parts should be cleaned with a soft damp cloth. NEVER use solvents to clean plastic parts. They could possibly dissolve or otherwise damage the material.

▲WARNING Wear ANSI Z87.1 safety glasses while using compressed air.

FAILURE TO START

Should your tool fail to start, check to make sure the prongs on the cord plug are making good contact in the outlet. Also, check for blown fuses or open circuit breakers in the line.

LUBRICATION

This tool has been lubricated with a sufficient amount of high grade lubricant for the life of the unit under normal operating conditions. No further lubrication is necessary.

BRUSH INSPECTION (If applicable)

For your continued safety and electrical protection, brush inspection and replacement on this tool should ONLY be performed by an AUTHORIZED PORTER-CABLE SERVICE STATION or a PORTER-CABLE•DELTA FACTORY SERVICE CENTER.

At approximately 100 hours of use, take or send your tool to your nearest authorized Porter-Cable Service Station to be thoroughly cleaned and inspected. Have worn parts replaced and lubricated with fresh lubricant. Have new brushes installed, and test the tool for performance.

Any loss of power before the above maintenance check may indicate the need for immediate servicing of your tool. DO NOT CONTINUE TO OPERATE TOOL UNDER THIS CONDITION. If proper operating voltage is present, return your tool to the service station for immediate service.

SERVICE

REPLACEMENT PARTS

When servicing use only identical replacement parts.

SERVICE AND REPAIRS

All quality tools will eventually require servicing or replacement of parts due to wear from normal use. These operations, including brush inspection and replacement, should ONLY be performed by either an AUTHORIZED PORTER-CABLE SERVICE STATION or a PORTER-CABLE•DELTA FACTORY SERVICE CENTER. All repairs made by these agencies are fully guaranteed against defective material and workmanship. We cannot guarantee repairs made or attempted by anyone other than these agencies.

Should you have any questions about your tool, feel free to write us at any time. In any communications, please give all information shown on the nameplate of your tool (model number, type, serial number, etc.).

ACCESSORIES

A complete line of accessories is available from your Porter-Cable•Delta Supplier, Porter-Cable•Delta Factory Service Centers, and Porter-Cable Authorized Service Stations. Please visit our Web Site www.porter-cable.com for a catalog or for the name of your nearest supplier.

▲ WARNING

Since accessories other than those offered by Porter-Cable•Delta have not been tested with this product, use of such accessories could be hazardous. For safest operation, only Porter-Cable•Delta recommended accessories should be used with this product.

WARRANTY

PORTER-CABLE LIMITED ONE YEAR WARRANTY

Porter-Cable warrants its Professional Power Tools for a period of one year from the date of original purchase. We will repair or replace at our option, any part or parts of the product and accessories covered under this warranty which, after examination, proves to be defective in workmanship or material during the warranty period. For repair or replacement return the complete tool or accessory, transportation prepaid, to your nearest Porter-Cable Service Center or Authorized Service Station. Proof of purchase may be required. This warranty does not apply to repair or replacement required due to misuse, abuse, normal wear and tear or repairs attempted or made by other than our Service Centers or Authorized Service Stations.

ANY IMPLIED WARRANTY, INCLUDING THE IMPLIED WARRANTIES OF MERCHANTABILITY AND FITNESS FOR A PARTICULAR PURPOSE, WILL LAST ONLY FOR ONE (1) YEAR FROM THE DATE OF PURCHASE.

To obtain information on warranty performance please write to: PORTER-CABLE CORPORATION, 4825 Highway 45 North, Jackson, Tennessee 38305; Attention: Product Service. THE FOREGOING OBLIGATION IS PORTER-CABLE'S SOLE LIABILITY UNDER THIS OR ANY IMPLIED WARRANTY AND UNDER NO CIRCUMSTANCES SHALL PORTER-CABLE BE LIABLE FOR ANY INCIDENTAL OR CONSEQUENTIAL DAMAGES. Some states do not allow limitations on how long an implied warranty lasts or the exclusion or limitation of incidental or consequential damages, so the above limitation or exclusion may not apply to you.

This warranty gives you specific legal rights and you may also have other legal rights which vary from state to state.

PORTER-CABLE • DELTA SERVICE CENTERS (CENTROS DE SERVICIO DE PORTER-CABLE • DELTA) (CENTRE DE SERVICE PORTER-CABLE • DELTA)

**Parts and Repair Service for Porter-Cable • Delta Power Tools are Available at These Locations
(Obtenga Refacción de Partes o Servicio para su Herramienta en los Sigüientes Centros de Porter-Cable • Delta)
(Locations où vous trouverez les pièces de rechange nécessaires ainsi qu'un service d'entretien)**

ARIZONA

Tempe 85282 (Phoenix)
2400 West Southern Avenue
Suite 105
Phone: (602) 437-1200
Fax: (602) 437-2200

CALIFORNIA

Ontario 91761 (Los Angeles)
3949A East Guasti Road
Phone: (909) 390-5555
Fax: (909) 390-5554

San Diego 92111
7638 Clairemont Blvd.
Phone: (858) 277-9595
Fax: (858) 277-9696

San Leandro 94577 (Oakland)
3039 Teagarden Street
Phone: (510) 357-9762
Fax: (510) 357-7939

COLORADO

Arvada 80003 (Denver)
8175 Sheridan Blvd., Unit S
Phone: (303) 487-1809
Fax: (303) 487-1868

FLORIDA

Davie 33314 (Miami)
4343 South State Rd. 7 (441)
Unit #107
Phone: (954) 321-6635
Fax: (954) 321-6638

Tampa 33609
4538 W. Kennedy Boulevard
Phone: (813) 877-9585
Fax: (813) 289-7948

GEORGIA

Forest Park 30297 (Atlanta)
5442 Frontage Road,
Suite 112
Phone: (404) 608-0006
Fax: (404) 608-1123

ILLINOIS

Addison 60101 (Chicago)
400 South Rohwing Rd.
Phone: (630) 424-8805
Fax: (630) 424-8895

Woodridge 60517 (Chicago)
2033 West 75th Street
Phone: (630) 910-9200
Fax: (630) 910-0360

MARYLAND

Elkridge 21075 (Baltimore)
7397-102 Washington Blvd.
Phone: (410) 799-9394
Fax: (410) 799-9398

MASSACHUSETTS

Franklin 02038 (Boston)
Franklin Industrial Park
101E Constitution Blvd.
Phone: (508) 520-8802
Fax: (508) 528-8089

MICHIGAN

Madison Heights 48071 (Detroit)
30475 Stephenson Highway
Phone: (248) 597-5000
Fax: (248) 597-5004

MINNESOTA

Minneapolis 55429
5522 Lakeland Avenue North
Phone: (763) 561-9080
Fax: (763) 561-0653

MISSOURI

North Kansas City 64116
1141 Swift Avenue
Phone: (816) 221-2070
Fax: (816) 221-2897

St. Louis 63119

7574 Watson Road
Phone: (314) 968-8950
Fax: (314) 968-2790

NEW YORK

Flushing 11365-1595 (N.Y.C.)
175-25 Horace Harding Expwy.
Phone: (718) 225-2040
Fax: (718) 426-1919

NORTH CAROLINA

Charlotte 28270
9129 Monroe Road, Suite 115
Phone: (704) 841-1176
Fax: (704) 708-4625

OHIO

Columbus 43214
4560 Indianola Avenue
Phone: (614) 263-0929
Fax: (614) 263-1238

Cleveland 44125
8001 Sweet Valley Drive
Unit #19
Phone: (216) 447-9030
Fax: (216) 447-3097

OREGON

Portland 97230
4916 NE 122 nd Ave.
Phone: (503) 252-0107
Fax: (503) 252-2123

PENNSYLVANIA

Willow Grove 19090 (Philadelphia)
520 North York Road
Phone: (215) 658-1430
Fax: (215) 658-1433

TEXAS

Carrollton 75006 (Dallas)
1300 Interstate 35 N, Suite 112
Phone: (972) 446-2996
Fax: (972) 446-8157

HOUSTON

Houston 77043
4321 Sam Houston Parkway, West
Suite 180
Phone: (713) 983-9910
Fax: (713) 983-6645

WASHINGTON

Auburn 98001 (Seattle)
3320 West Valley HWY, North
Building D, Suite 111
Phone: (253) 333-8353
Fax: (253) 333-9613

Authorized Service Stations are located in many large cities. Telephone **800-487-8665** or **731-541-6042** for assistance locating one. Parts and accessories for Porter-Cable • Delta products should be obtained by contacting any Porter-Cable • Delta Distributor, Authorized Service Center, or Porter-Cable • Delta Factory Service Center. If you do not have access to any of these, call **888-848-5175** and you will be directed to the nearest Porter-Cable • Delta Factory Service Center. Las Estaciones de Servicio Autorizadas están ubicadas en muchas grandes ciudades. Llame al **800-487-8665** ó al **731-541-6042** para obtener asistencia a fin de localizar una. Las piezas y los accesorios para los productos Porter-Cable • Delta deben obtenerse poniéndose en contacto con cualquier distribuidor Porter-Cable • Delta, Centro de Servicio Autorizado o Centro de Servicio de Fábrica Porter-Cable • Delta. Si no tiene acceso a ninguna de estas opciones, llame al **888-848-5175** y le dirigirá al Centro de Servicio de Fábrica Porter-Cable • Delta más cercano. Des centres de service agréés sont situés dans beaucoup de grandes villes. Appelez au **800-487-8665** ou au **731-541-6042** pour obtenir de l'aide pour en repérer un. Pour obtenir des pièces et accessoires pour les produits Porter-Cable • Delta, s'adresser à tout distributeur Porter-Cable • Delta, centre de service agréé ou centre de service d'usine Porter-Cable • Delta. Si vous n'avez accès à aucun de ces centres, appeler le **888-848-5175** et on vous dirigera vers le centre de service d'usine Porter-Cable • Delta le plus proche.

CANADIAN PORTER-CABLE • DELTA SERVICE CENTERS

ALBERTA

Bay 6, 2520-23rd St. N.E.
Calgary, Alberta
T2E 8L2
Phone: (403) 735-6166
Fax: (403) 735-6144

BRITISH COLUMBIA

8520 Baxter Place
Burnaby, B.C.
V5A 4T8
Phone: (604) 420-0102
Fax: (604) 420-3522

MANITOBA

1699 Dublin Avenue
Winnipeg, Manitoba
R3H 0H2
Phone: (204) 633-9259
Fax: (204) 632-1976

ONTARIO

505 Southgate Drive
Guelph, Ontario
N1H 6M7
Phone: (519) 767-4132
Fax: (519) 767-4131

QUÉBEC

1515 Ave.
St-Jean Baptiste, Suite 160
Québec, P.Q.
G2E 5E2
Phone: (418) 877-7112
Fax: (418) 877-7123

1447, Begin
St-Laurent, (Mtl), P.Q.
H4R 1V8
Phone: (514) 336-8772
Fax: (514) 336-3505

The following are trademarks of PORTER-CABLE • DELTA (Las siguientes son marcas registradas de PORTER-CABLE • DELTA S.A.) (Les marques suivantes sont des marques de fabricant de la PORTER-CABLE • DELTA): Auto-Set®, BAMMER®, B.O.S.S.®, Builder's Saw®, Contractor's Saw®, Contractor's Saw II™, Delta™, DELTACRAFT™, DELTAGRAM™, Delta Series 2000™, DURATRONIC™, Erc™, FLEX™, Flying Chips™, FRAME SAW®, Grip Vac™, Homecraft®, INNOVATION THAT WORKS®, Jet-Lock®, JETSTREAM®, kickstand®, LASERLOC®, MICRO-SET®, Micro-Set™, MIDI LATHE®, MORTEN™, NETWORK™, OMNIJIG®, POCKET CUTTER®, PORTA-BAND®, PORTA-PLANE®, PORTER-CABLE®&(design), PORTER-CABLE®PROFESSIONAL POWER TOOLS, PORTER-CABLE REDEFINING PERFORMANCE™, Posi-Matic®, Q-3®&(design), QUICKSAND®&(design), QUICKSET™, QUICKSET II®, QUICKSET PLUS™, RIPTIDE™&(design), SAFE GUARD II®, SAFE-LOC®, Sanding Center®, SANDTRAP®&(design), SAW BOSS®, Sawbuck™, Sidekick®, SPEED-BLOC®, SPEEDMATIC®, SPEEDTRONIC®, STAIR EASE®, The American Woodshop®&(design), The Lumber Company®&(design), THE PROFESSIONAL EDGE®, THE PROFESSIONAL SELECT®, THIN-LINE™, TIGER®, TIGER CUB®, TIGER SAW®, TORQBUSTER®, TORQ-BUSTER®, TRU-MATCH™, TWIN-LITE™, UNIGUARD®, Unifence®, UNIFEEEDER™, Unihead™, Uniplane™, Unirip™, Unisaw®, Univise®, Versa-Feeder®, VERSA-PLANE®, WHISPER SERIES®, WOODWORKER'S CHOICE™.

Trademarks noted with ™ and ® are registered in the United States Patent and Trademark Office and may also be registered in other countries. Las Marcas Registradas con el signo de ™ y ® son registradas por la Oficina de Registros y Patentes de los Estados Unidos y también pueden estar registradas en otros países. Marques déposées, indiquées par la lettre ™ et ®, sont déposées au Bureau des brevets d'invention et marques déposées.

Free Manuals Download Website

<http://myh66.com>

<http://usermanuals.us>

<http://www.somanuals.com>

<http://www.4manuals.cc>

<http://www.manual-lib.com>

<http://www.404manual.com>

<http://www.luxmanual.com>

<http://aubethermostatmanual.com>

Golf course search by state

<http://golfingnear.com>

Email search by domain

<http://emailbydomain.com>

Auto manuals search

<http://auto.somanuals.com>

TV manuals search

<http://tv.somanuals.com>