

ESPAÑOL: PÁGINA 13
FRANÇAISE : PAGE 25

Instruction manual

Double Insulated Portable Electric Drill

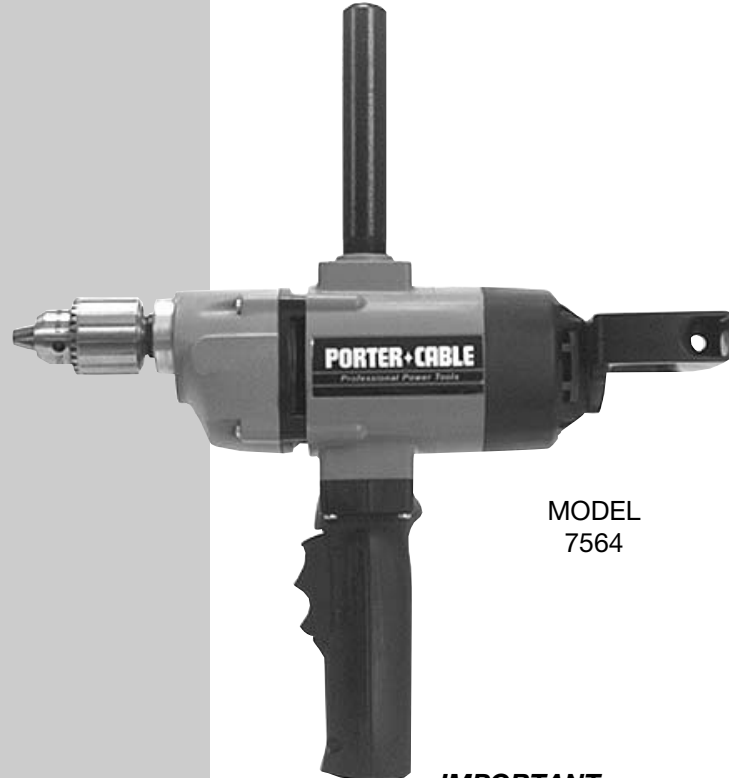

MODEL
7564

IMPORTANT

Please make certain that the person who is to use this equipment carefully reads and understands these instructions before starting operations.

To learn more about Porter-Cable
visit our website at:

<http://www.porter-cable.com>

PORTER-CABLE
PROFESSIONAL POWER TOOLS

Copyright © 2001 Porter-Cable Corporation

The Model and Serial No. plate is located on the main housing of the tool. Record these numbers in the spaces below and retain for future reference.

Model No. _____

Type _____

Serial No. _____

Part No. 903549 - 09-30-01

⚠ WARNING: SOME DUST CREATED BY POWER SANDING, SAWING, GRINDING, DRILLING, AND OTHER CONSTRUCTION ACTIVITIES

contains chemicals known to cause cancer, birth defects or other reproductive harm. Some examples of these chemicals are:

- lead from lead-based paints,
- crystalline silica from bricks and cement and other masonry products, and
- arsenic and chromium from chemically-treated lumber.

Your risk from these exposures varies, depending on how often you do this type of work. To reduce your exposure to these chemicals: work in a well ventilated area, and work with approved safety equipment, such as those dust masks that are specially designed to filter out microscopic particles.

GENERAL SAFETY RULES

⚠ WARNING: READ AND UNDERSTAND ALL INSTRUCTIONS. Failure to follow all instructions listed below, may result in electric shock, fire and/or serious personal injury.

SAVE THESE INSTRUCTIONS.

WORK AREA

1. **Keep your work area clean and well lit.** Cluttered benches and dark areas invite accidents.
2. **Do not operate power tools in explosive atmospheres, such as in the presence of flammable liquids, gases, or dust.** Power tools create sparks which may ignite the dust or fumes.
3. **Keep bystanders, children, and visitors away while operating a power tool.** Distractions can cause you to lose control.

ELECTRICAL SAFETY

1. **Double insulated tools are equipped with a polarized plug (one blade is wider than the other). This plug will fit in a polarized outlet only one way. If the plug does not fit fully in the outlet, reverse the plug. If it still does not fit, contact a qualified electrician to install a polarized outlet. Do not change the plug in any way.** Double Insulation eliminates the need for the three wire grounded power cord and grounded power supply system.
2. **Avoid body contact with grounded surfaces such as pipes, radiators, ranges and refrigerators.** There is an increased risk of electric shock if your body is grounded.
3. **Don't expose power tools to rain or wet conditions.** Water entering a power tool will increase the risk of electric shock.
4. **Do not abuse the cord. Never use the cord to carry the tools or pull the plug from an outlet. Keep cord away from heat, oil, sharp edges or moving parts. Replace damaged cords immediately.** Damaged cords increase the risk of electric shock.
5. **When operating a power tool outside, use an outdoor extension cord marked "W-A" or "W".** These cords are rated for outdoor use and reduce the risk of electric shock.

PERSONAL SAFETY

1. **Stay alert, watch what you are doing, and use common sense when operating a power tool. Do not use tool while tired or under the**

influence of drugs, alcohol, or medication. A moment of inattention while operating power tools may result in serious personal injury.

2. Dress properly. Do not wear loose clothing or jewelry. Contain long hair. Keep your hair, clothing, and gloves away from moving parts. Loose clothes, jewelry, or long hair can be caught in moving parts.

3. Avoid accidental starting. Be sure switch is OFF before plugging in. Carrying tools with your finger on the switch or plugging in tools that have the switch ON invites accidents.

4. Remove adjusting keys or wrenches before turning the tool ON. A wrench or a key that is left attached to a rotating part of the tool may result in personal injury.

5. Do not overreach. Keep proper footing and balance at all times. Proper footing and balance enable better control of the tool in unexpected situations.

6. Use safety equipment. Always wear eye protection. Dust mask, non-skid safety shoes, hard hat, or hearing protection must be used for appropriate conditions.

TOOLS USE AND CARE

1. Use clamps or other practical way to secure and support the workpiece to a stable platform. Holding the work by hand or against your body is unstable and may lead to loss of control.

2. Do not force tool. Use the correct tool for your application. The correct tool will do the job better and safer at the rate for which it is designed.

3. Do not use tool if switch does not turn it ON or OFF. A tool that cannot be controlled with the switch is dangerous and must be repaired.

4. Disconnect the plug from the power source before making any adjustments, changing accessories, or storing the tool. Such preventive safety measures reduce the risk of starting the tool accidentally.

5. Store idle tools out of reach of children and other untrained persons. Tools are dangerous in the hands of untrained users.

6. Maintain tools with care. Keep cutting tools sharp and clean. Properly maintained tools, with sharp cutting edges are less likely to bind and are easier to control.

7. Check for misalignment or binding of moving parts, breakage of parts, and any other condition that may affect the tool's operation. If damaged, have the tool serviced before using. Many accidents are caused by poorly maintained tools.

8. Use only accessories that are recommended by the manufacturer for your model. Accessories that may be suitable for one tool may become hazardous when used on another tool.

SERVICE



1. Tool service must be performed only by qualified repair personnel. Service or maintenance performed by unqualified personnel may result in a risk of injury.





2. When servicing a tool, use only identical replacement parts. Follow instructions in the Maintenance Section of this manual. Use of unauthorized parts or failure to follow Maintenance Instructions may create a risk of electric shock or injury.

SPECIFIC SAFETY RULES AND SYMBOLS FOR PORTABLE DRILLS

1. **ALWAYS** hold drill by the handle(s) ONLY to prevent accidental electrical shock resulting from cutting a live wire when drilling into a wall or other blind areas.
2. **DO NOT** use bits larger than those recommended. They increase the chance of jamming. Large bits may also overload the drill and damage the motor and gears.
3. **USE ONLY** the proper chuck key to tighten or loosen the chuck. Do not use chuck if jaws or other parts are cracked or worn.
4. **VERIFY** the drill's rotation before starting the drill so it is correct for the operation being performed.
5. **NEVER** change direction or rotation of reversing model until motor has completely stopped.
6. **NEVER** hold work in your hand, lap, or against other parts of your body when drilling.
7. **DO NOT** use drill as a router or try to elongate or enlarge holes by twisting the drill. Drill bits may break and cause injury.
8. **DO NOT USE ON LADDER OR SCAFFOLD.** Reaction torque may cause loss of balance.
9. **SOME WOOD CONTAINS PRESERVATIVES WHICH CAN BE TOXIC.** Take extra care to prevent inhalation and skin contact when working with these materials. Request, and follow, any safety information available from your material supplier.
10. **⚠ WARNING:** There are certain applications for which this tool was designed. Porter-Cable strongly recommends that this tool NOT be modified and/or used for any application other than for which it was designed. If you have any questions relative to its application DO NOT use the tool until you have written Porter-Cable and we have advised you.

Technical Service Manager
 Porter-Cable Corporation
 4825 Highway 45 North
 Jackson, TN 38305

SYMBOL	DEFINITION
V volts
A amperes
Hz hertz
W watts
kW kilowatts
μF microfarads
l liters
kg kilograms
N/cm ² newtons per square centimeter
Pa pascals
h hours
min minutes
s seconds
 alternating current
3  three-phase alternating current
3N  three-phase alternating current with neutral

-  direct current
- n_0 no load
-  alternating or direct current
-  Class II Construction
-  splash-proof construction
-  watertight construction
- .../min revolutions or reciprocation per minute

REPLACEMENT PARTS

When servicing use only identical replacement parts.

MOTOR

Many Porter-Cable tools will operate on either D.C., or single phase 25 to 60 cycle A.C. current and voltage within plus or minus 5 percent of that shown on the specification plate on the tool. Several models, however, are designed for A.C. current only. Refer to the specification plate on your tool for proper voltage and current rating.

CAUTION: Do not operate your tool on a current on which the voltage is not within correct limits. Do not operate tools rated A.C. only on D.C. current. To do so may seriously damage the tool.

EXTENSION CORD SELECTION

If an extension cord is used, make sure the conductor size is large enough to prevent excessive voltage drop which will cause loss of power and possible motor damage. A table of recommended extension cord sizes will be found in this section. This table is based on limiting line voltage drop to 5 volts (10 volts for 230 volts) at 150% of rated amperes.

If an extension cord is to be used outdoors it must be marked with the suffix W-A or W following the cord type designation. For example – SJTW-A to indicate it is acceptable for outdoor use.

RECOMMENDED EXTENSION CORD SIZES FOR USE WITH PORTABLE ELECTRIC TOOLS

		Length of Cord in Feet									
		115V	25 Ft.	50 Ft.	100 Ft.	150 Ft.	200 Ft.	250 Ft.	300 Ft.	400 Ft.	500 Ft.
Nameplate Ampere Rating	230V	50 Ft.	100 Ft.	200 Ft.	300 Ft.	400 Ft.	500 Ft.	600 Ft.	800 Ft.	1000 Ft.	
	0-2	18	18	18	16	16	14	14	12	12	
	2-3	18	18	16	14	14	12	12	10	10	
	3-4	18	18	16	14	12	12	10	10	8	
	4-5	18	18	14	12	12	10	10	8	8	
	5-6	18	16	14	12	10	10	8	8	6	
	6-8	18	16	12	10	10	8	6	6	6	
	8-10	18	14	12	10	8	8	6	6	4	
	10-12	16	14	10	8	8	6	6	4	4	
	12-14	16	12	10	8	6	6	6	4	2	
	14-16	16	12	10	8	6	6	4	4	2	
	16-18	14	12	8	8	6	4	4	2	2	
	18-20	14	12	8	6	6	4	4	2	2	

FUNCTIONAL DESCRIPTION

FOREWORD

Porter-Cable Model 7564 Drill is designed to drill holes of various sizes up to 1³/₄" in wood and 1/2" in metal.

INSTALLING AND REMOVING DRILL BIT

1. **CAUTION:** DISCONNECT TOOL FROM POWER SOURCE.
2. The three-jaw chuck is designed for self-centering of the drill bit. Open chuck jaws by turning outer sleeve counterclockwise, when viewing the chuck from the bit end. Open large enough so that bit shank can be inserted.
3. Clean and insert smooth end of drill bit as far as it will go into the chuck, or up to the flutes for small bits.
4. While holding the bit with one hand, turn outer sleeve clockwise until bit is gripped in the chuck.
5. Tighten chuck – insert chuck key into each of 3 keyholes in chuck body (Fig. 1) in succession and tighten securely by turning key clockwise.

CAUTION: Be sure chuck key is removed before starting tool.

6. To remove bit, reverse this procedure.

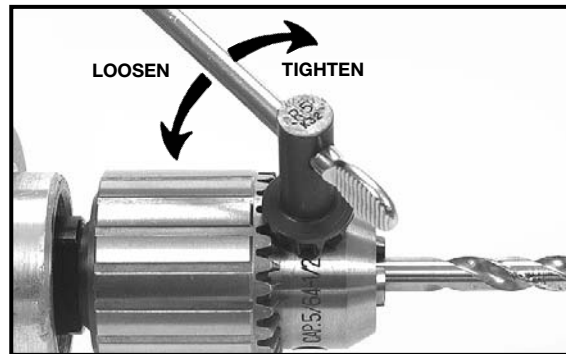

Fig. 1

ASSEMBLY

TO INSTALL SPADE HANDLE

A spade handle (D) Fig. 2, is furnished with the tool. This handle may be assembled in any one of four positions on the back of the drill. Place the washer on the screw, insert screw through hole in spade handle, locate handle as desired, and tighten screw securely. The spade handle was designed to carry or transport the tool only. NEVER hold the tool by the spade handle during drilling operations.

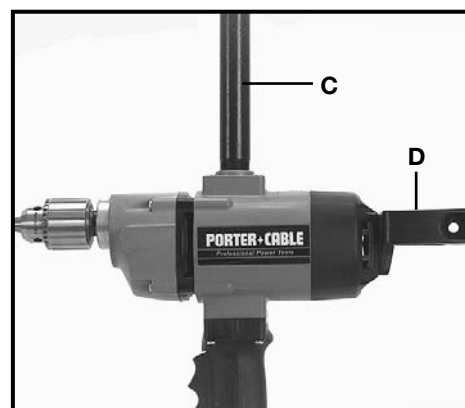

Fig. 2

TO INSTALL AUXILIARY HANDLE

An auxiliary handle (C) Fig. 2, is supplied with some models. This handle screws directly into the drill housing providing complete control of the drill.

It is strongly recommended that the auxiliary handle be used and tool held as illustrated in Fig. 4 during all drilling operations.

OPERATION

TO START AND STOP THE MACHINE

1. **CAUTION:** Make sure switch is OFF and power circuit voltage is the same as that shown on the specification plate.
2. Connect tool to power circuit.
3. Grip machine firmly to resist starting torque.

4. To START the machine in FORWARD (clockwise rotation), depress the bottom of the trigger switch (A) Fig. 3.

To START the machine in REVERSE (counterclockwise rotation), depress the top of the trigger switch (B) Fig. 3.

NOTE: Allow motor to stop before attempting to reverse direction of rotation. Failure to do so, could damage motor.

5. TO STOP the machine, release the trigger switch.

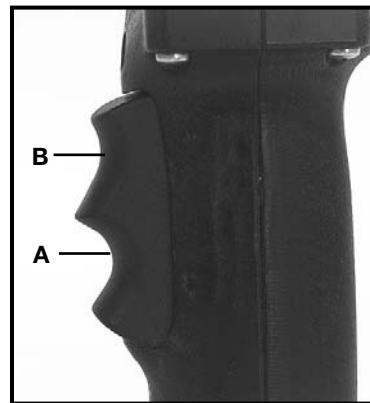

Fig. 3

HOW TO HOLD THE DRILL

⚠ WARNING: The front end of drill may be made live if the tool drills into live wiring in a wall. TO PREVENT ACCIDENTAL ELECTRICAL SHOCK, DRILL MUST BE HELD AS SHOWN IN FIG. 4.

An auxiliary handle (C) Fig. 2, is supplied with each drill. The auxiliary handle should be used during all drilling operations: firmly grasp auxiliary handle with one hand and switch handle with the other hand as shown in Fig. 4.

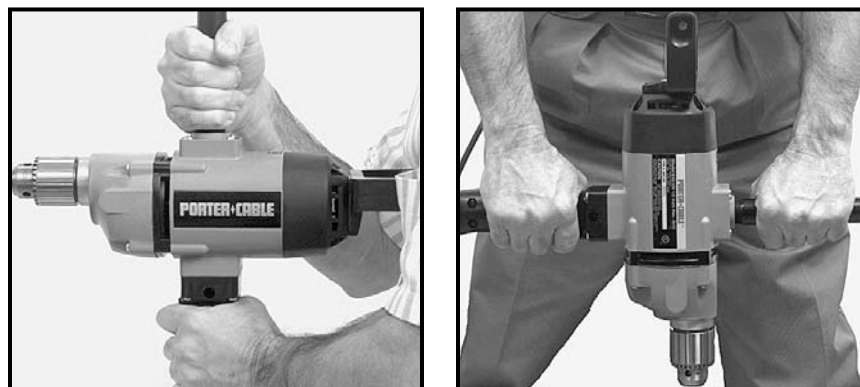

Fig. 4

HOW TO USE THE DRILL

GENERAL DRILLING

1. Be sure drill bit is securely gripped in chuck. (See INSTALLING AND REMOVING DRILL BIT).
2. Make sure work is held securely in vise or clamped in place prior to starting drilling operation.

CAUTION: Loose work may spin and cause bodily injury.

3. Locate exact center for hole to be drilled and using a center punch, make a small dent in work.
4. Place tip of drill bit in dent made by center punch, hold drill square with work, and start the motor.

Apply steady, even pressure to keep drill bit cutting. Too little pressure will keep the bit from cutting and dull the edges due to excessive friction created by sliding over the surface.

CAUTION: Too much pressure may cause the bit to break or overheat resulting in bodily injury or damaged drill bits.

CAUTION: BE ALERT and brace yourself against the twisting action of the drill, should the bit jam in the work.

5. If drill stalls or becomes jammed in the hole, release trigger immediately, remove drill bit from work and determine cause of stalling or jamming. DO NOT SQUEEZE TRIGGER ON AND OFF IN AN ATTEMPT TO FREE A STALLED OR JAMMED DRILL – THIS WILL DAMAGE THE MOTOR. The direction of rotation may be reversed to help free a jammed bit.
6. Reduce the pressure on the drill just before the bit cuts through the work to avoid splintering wood or stalling in metal.
7. When bit has completely penetrated work and is spinning freely, withdraw it from the work while the motor is still running, then turn off drill.

DRILLING WOOD

In addition to the instructions listed under GENERAL DRILLING, the following also apply:

1. When using twist drills in wood, they should be withdrawn from the hole frequently to clear chips built up in flutes to avoid overheating and burning work.
2. If a backing block is used to keep back of work from splintering, it should be clamped securely in place. If a backing block is not used with spade bits or auger bits, ease up pressure as soon as bit point breaks through work, and complete the hole from the opposite side.

DRILLING METAL

In addition to the instructions listed under GENERAL DRILLING, the following also apply:

CAUTION: When drilling metal, jamming of bit is more likely than when drilling other materials.

1. Use only good quality sharp high speed steel twist bits when drilling metal.
2. Start drilling with slow speed and gradually increase speed as drill cuts.

The harder the material, the slower the speed required. The softer the material, the faster the speed.

3. When drilling a large hole, it is easier to first drill a smaller hole and then enlarge it to the required size.
4. The use of a lubricant, such as oil, on the drill point helps keep the bit cool, increases drilling action and prolongs drill bit life.

MAINTENANCE

KEEP TOOL CLEAN

Periodically blow out all air passages with dry compressed air. All plastic parts should be cleaned with a soft damp cloth. NEVER use solvents to clean plastic parts. They could possibly dissolve or otherwise damage the material.

CAUTION: Wear safety glasses while using compressed air.

FAILURE TO START

Should your tool fail to start, check to make sure the prongs on the cord plug are making good contact in the outlet. Also, check for blown fuses or open circuit breakers in the line.

CHUCK REPLACEMENT

1. **CAUTION:** DISCONNECT TOOL FROM POWER SOURCE.
2. Open chuck jaws as wide as possible to gain access to the chuck retaining screw.
3. Remove chuck retaining screw. Turn screw clockwise (left hand threads).
4. Place the short end of a large hex wrench ($\frac{1}{4}$ " or larger) into the chuck. Align wrench flats with chuck jaws and tighten chuck securely using chuck key. While supporting chuck on a solid surface, position hex wrench to left (see Fig. 5) and strike wrench a sharp blow with a hammer to loosen chuck. Turn chuck counterclockwise to remove.
5. **INSTALL CHUCK:** Open jaws of replacement chuck as wide as possible. Thread chuck by turning chuck clockwise. Hand tighten. Install hex wrench in chuck (see Step 4). While supporting chuck on a solid surface, position hex wrench to the right (see Fig. 6) and strike a sharp blow with a hammer to seat chuck onto spindle.
6. Remove hex wrench from chuck.
7. **INSTALL CHUCK RETAINING SCREW.** Turn screw counterclockwise and tighten securely.

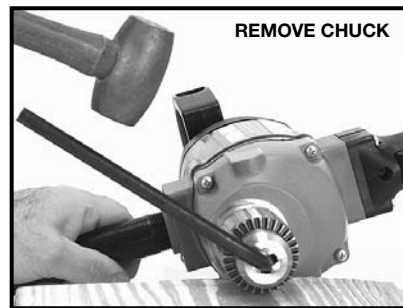

Fig. 5

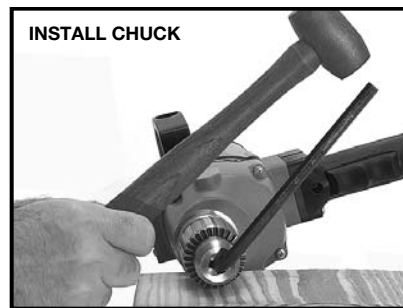

Fig. 6

LUBRICATION

This tool has been lubricated with a sufficient amount of high grade lubricant for the life of the unit under normal operating conditions. No further lubrication is necessary.

BRUSH INSPECTION AND LUBRICATION

For your continued safety and electrical protection, brush inspection and replacement on this tool should ONLY be performed by an AUTHORIZED PORTER-CABLE SERVICE STATION or a PORTER-CABLE/DELTA FACTORY SERVICE CENTER.

At approximately 100 hours of use, take or send your tool to your nearest authorized Porter-Cable Service Station to be thoroughly cleaned and inspected. Have worn parts replaced and lubricate with fresh lubricant. Have new brushes installed, and test the tool for performance.

Any loss of power before the above maintenance check may indicate the need for immediate servicing of your tool. DO NOT CONTINUE TO OPERATE TOOL UNDER THIS CONDITION. If proper operating voltage is present, return your tool to the service station for immediate service.

SERVICE AND REPAIRS

All quality tools will eventually require servicing or replacement of parts due to wear from normal use. These operations, including brush inspection and replacement, should ONLY be performed by either an AUTHORIZED PORTER-CABLE SERVICE STATION or a PORTER-CABLE/DELTA FACTORY SERVICE CENTER. All repairs made by these agencies are fully guaranteed against defective material and workmanship. We cannot guarantee repairs made or attempted by anyone other than these agencies.

Should you have any questions about your tool, feel free to write us at any time. In any communications, please give all information shown on the nameplate of your tool (model number, type, serial number, etc.).

ACCESSORIES

A complete line of accessories is available from your Porter-Cable • Delta Supplier, Porter-Cable • Delta Factory Service Centers, and Porter-Cable Authorized Service Stations. Please visit our Web Site www.porter-cable.com for a catalog or for the name of your nearest supplier.

⚠ WARNING: Since accessories other than those offered by Porter-Cable • Delta have not been tested with this product, use of such accessories could be hazardous. For safest operation, only Porter-Cable • Delta recommended accessories should be used with this product.

NOTES

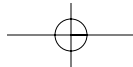
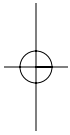

PORTER-CABLE LIMITED ONE YEAR WARRANTY

Porter-Cable warrants its Professional Power Tools for a period of one year from the date of original purchase. We will repair or replace at our option, any part or parts of the product and accessories covered under this warranty which, after examination, proves to be defective in workmanship or material during the warranty period. For repair or replacement return the complete tool or accessory, transportation prepaid, to your nearest Porter-Cable Service Center or Authorized Service Station. Proof of purchase may be required. This warranty does not apply to repair or replacement required due to misuse, abuse, normal wear and tear or repairs attempted or made by other than our Service Centers or Authorized Service Stations.

ANY IMPLIED WARRANTY, INCLUDING THE IMPLIED WARRANTIES OF MERCHANTABILITY AND FITNESS FOR A PARTICULAR PURPOSE, WILL LAST ONLY FOR ONE (1) YEAR FROM THE DATE OF PURCHASE.

To obtain information on warranty performance please write to: PORTER-CABLE CORPORATION, 4825 Highway 45 North, Jackson, Tennessee 38305; Attention: Product Service. THE FOREGOING OBLIGATION IS PORTER-CABLE'S SOLE LIABILITY UNDER THIS OR ANY IMPLIED WARRANTY AND UNDER NO CIRCUMSTANCES SHALL PORTER-CABLE BE LIABLE FOR ANY INCIDENTAL OR CONSEQUENTIAL DAMAGES. Some states do not allow limitations on how long an implied warranty lasts or the exclusion or limitation of incidental or consequential damages, so the above limitation or exclusion may not apply to you.

This warranty gives you specific legal rights and you may also have other legal rights which vary from state to state.

**PORTER-CABLE • DELTA SERVICE CENTERS
(CENTROS DE SERVICIO DE PORTER-CABLE • DELTA)
(CENTRE DE SERVICE PORTER-CABLE • DELTA)**

**Parts and Repair Service for Porter-Cable • Delta Power Tools are Available at These Locations
(Obtenga Refaccion de Partes o Servicio para su Herramienta en los Siguietes Centros de Porter-Cable • Delta)
(Locations où vous trouverez les pièces de rechange nécessaires ainsi qu'un service d'entretien)**

ARIZONA Tempe 85282 (Phoenix) 2400 West Southern Avenue Suite 105 Phone: (602) 437-1200 Fax: (602) 437-2200	ILLINOIS Addison 60101 (Chicago) 311 Laura Drive Phone: (630) 628-6100 Fax: (630) 628-0023	MINNESOTA Cleveland 44125 8001 Sweet Valley Drive Unit #19 Phone: (216) 447-9030 Fax: (216) 447-3097	OREGON Portland 97230 4916 NE 122 nd Ave. Phone: (503) 252-0107 Fax: (503) 252-2123
CALIFORNIA Ontario 91761 (Los Angeles) 3949A East Guasti Road Phone: (909) 390-5555 Fax: (909) 390-5554	Woodridge 60517 (Chicago) 2033 West 75th Street Phone: (630) 910-9200 Fax: (630) 910-0360	MISSOURI North Kansas City 64116 1141 Swift Avenue P.O. Box 12393 Phone: (816) 221-2070 Fax: (816) 221-2897	PENNSYLVANIA Wilmington 19090 520 North York Road Phone: (215) 658-1430 Fax: (215) 658-1433
San Leandro 94577 (Oakland) 3039 Teagarden Street Phone: (510) 357-9762 Fax: (510) 357-7939	MARYLAND Elkridge 21075 (Baltimore) 7397-102 Washington Blvd. Phone: (410) 799-9394 Fax: (410) 799-9398	St. Louis 63119 7574 Watson Road Phone: (314) 968-8950 Fax: (314) 968-2790	TEXAS Carrollton 75006 (Dallas) 1300 Interstate 35 N, Suite 112 Phone: (972) 446-2996 Fax: (972) 446-8157
FLORIDA Davie 33314 (Miami) 4343 South State Rd. 7 (441) Unit #107 Phone: (954) 321-6635 Fax: (954) 321-6638	MASSACHUSETTS Braintree 02185 (Boston) 719 Granite Street Phone: (781) 848-9810 Fax: (781) 848-6759	NEW YORK Flushing 11365-1595 (N.Y.C.) 175-25 Horace Harding Expwy. Phone: (718) 225-2040 Fax: (718) 423-9619	Houston 77055 West 10 Business Center 1008 Wirt Road, Suite 120 Phone: (713) 682-0334 Fax: (713) 682-4867
Tampa 33609 4538 W. Kennedy Boulevard Phone: (813) 877-9585 Fax: (813) 289-7948	Franklin 02038 (Boston) Franklin Industrial Park 101E Constitution Blvd. Phone: (508) 520-8802 Fax: (508) 528-8089	NORTH CAROLINA Charlotte 28270 9129 Monroe Road, Suite 115 Phone: (704) 841-1176 Fax: (704) 708-4625	WASHINGTON Renton 98055 (Seattle) 268 Southwest 43rd Street Phone: (425) 251-6680 Fax: (425) 251-9337
GEORGIA Forest Park 30297 (Atlanta) 5442 Frontage Road, Suite 112 Phone: (404) 608-0006 Fax: (404) 608-1123	MICHIGAN Madison Heights 48071 (Detroit) 30475 Stephenson Highway Phone: (248) 597-5000 Fax: (248) 597-5004	OHIO Columbus 43214 4560 Indianola Avenue Phone: (614) 263-0929 Fax: (614) 263-1238	

Authorized Service Stations are located in many large cities. Telephone **800-487-8665** or **731-541-6042** for assistance locating one. Parts and accessories for Porter-Cable • Delta products should be obtained by contacting any Porter-Cable • Delta Distributor, Authorized Service Center, or Porter-Cable • Delta Factory Service Center. If you do not have access to any of these, call **888-848-5175** and you will be directed to the nearest Porter-Cable • Delta Factory Service Center. Las Estaciones de Servicio Autorizadas están ubicadas en muchas grandes ciudades. Llame al **800-487-8665** ó al **731-541-6042** para obtener asistencia a fin de localizar una. Las piezas y los accesorios para los productos Porter-Cable • Delta deben obtenerse poniéndose en contacto con cualquier distribuidor Porter-Cable • Delta, Centro de Servicio Autorizado o Centro de Servicio de Fábrica Porter-Cable • Delta. Si no tiene acceso a ninguna de estas opciones, llame al **888-848-5175** y le dirigirán al Centro de Servicio de Fábrica Porter-Cable • Delta más cercano. Des centres de service agréés sont situés dans beaucoup de grandes villes. Appelez au **800-487-8665** ou au **731-541-6042** pour obtenir de l'aide pour en repérer un. Pour obtenir des pièces et accessoires pour les produits Porter-Cable • Delta, s'adresser à tout distributeur Porter-Cable • Delta, centre de service agréé ou centre de service d'usine Porter-Cable • Delta. Si vous n'avez accès à aucun de ces centres, appeler le **888-848-5175** et on vous dirigera vers le centre de service d'usine Porter-Cable • Delta le plus proche.

CANADIAN PORTER-CABLE • DELTA SERVICE CENTERS

ALBERTA Bay 6, 2520-23rd St. N.E. Calgary, Alberta T2E 8L2 Phone: (403) 735-6166 Fax: (403) 735-6144	MANITOBA 1699 Dublin Avenue Winnipeg, Manitoba R3H 0H2 Phone: (204) 633-9259 Fax: (204) 632-1976	QUÉBEC 1515 Ave. St-Jean Baptiste, Québec, Québec G2E 5E2 Phone: (418) 877-7112 Fax: (418) 877-7123
BRITISH COLUMBIA 8520 Baxter Place Burnaby, B.C. V5A 4T8 Phone: (604) 420-0102 Fax: (604) 420-3522	ONTARIO 505 Southgate Drive Guelph, Ontario N1H 6M7 Phone: (519) 836-2840 Fax: (519) 767-4131	1447, Begin St-Laurent, (Montréal), Québec H4R 1V8 Phone: (514) 336-8772 Fax: (514) 336-3505

The following are trademarks of PORTER-CABLE • DELTA (Las siguientes son marcas registradas de PORTER-CABLE • DELTA S.A.) (Les marques suivantes sont des marques de fabriquant de la PORTER-CABLE • DELTA): BAMMER®, LASERLOC®, OMNIJIG®, POCKET CUTTER®, PORTA-BAND®, PORTA-PLANE®, PORTER-CABLE®, QUICKSAND®, SANDTRAP®, SAW BOSS®, SPEED-BLOC®, SPEEDMATIC®, SPEEDTRONIC®, STAIR-EASE®, THE PROFESSIONAL EDGE®, THE PROFESSIONAL SELECT®, TIGER CUB®, TIGER SAW®, TORQ-BUSTER®, VERSA-PLANE®, WHISPER SERIES®, DURATRAC™, FRAME SAW™, INNOVATION THAT WORKS™, JETSTREAM™, MICRO-SET™, MORTEN™, NETWORK™, RIPTIDE™, TRU-MATCH™, WOODWORKER'S CHOICE™, THE AMERICAN WOOD SHOP™ (design), AUTO-SET™, B.O.S.S.™, BUILDER'S SAW™, CONTRACTOR'S SAW™, DELTA™, DELTACRAFT™, HOMECRAFT™, JET-LOCK™, KICKSTAND™, THE LUMBER COMPANY™ (design), MICRO-SET™, Q3™, QUICKSET II™, QUICKSET PLUS™, SAFEGUARD II™, SANDING CENTER™, SIDEKICK™, UNIFENCE™, UNIGUARD™, UNIRIP™, UNISAW™, VERSA-FEEDER™, TPS™, Emc™.

Trademarks noted with ™ and ® are registered in the United States Patent and Trademark Office and may also be registered in other countries. Las Marcas Registradas con el signo de ™ y ® son registradas por la Oficina de Registros y Patentes de los Estados Unidos y también pueden estar registradas en otros países. Marques déposées, indiquées par la lettre ™ et ®, sont déposées au Bureau des brevets d'invention et marques déposées aux Etats-Unis et pourraient être déposées aux autres pays.

Printed in U.S.A.

Free Manuals Download Website

<http://myh66.com>

<http://usermanuals.us>

<http://www.somanuals.com>

<http://www.4manuals.cc>

<http://www.manual-lib.com>

<http://www.404manual.com>

<http://www.luxmanual.com>

<http://aubethermostatmanual.com>

Golf course search by state

<http://golfingnear.com>

Email search by domain

<http://emailbydomain.com>

Auto manuals search

<http://auto.somanuals.com>

TV manuals search

<http://tv.somanuals.com>