

Instruction manual

BRAD NAILER

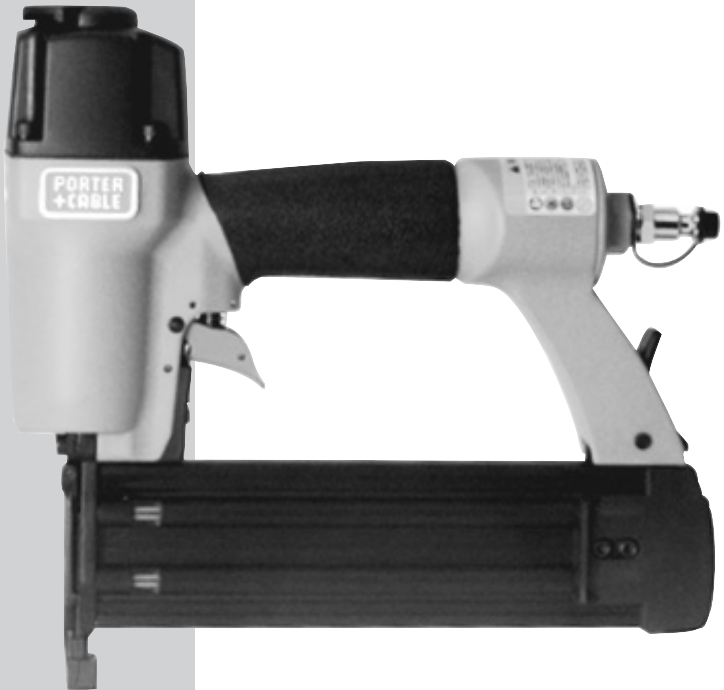

MODEL BN200A

IMPORTANT

Please make certain that the person who is to use this equipment carefully reads and understands these instructions before starting operations.

To learn more about Porter-Cable
visit our website at:

<http://www.porter-cable.com>

PORTER-CABLE
PROFESSIONAL POWER TOOLS

The Model and Serial No. plate is located on the main housing of the tool. Record these numbers in the spaces below and retain for future reference.

Model No. _____

Type _____

Serial No. _____



PORTER-CABLE

Porter-Cable Corporation
4825 Highway 45 North
P.O. Box 2468
Jackson, TN 38302-2468

GB ENGLISH

EC-DECLARATION OF CONFORMITY

We declare under our sole responsibility that this product is in conformity with the regulations 98/37/EEC.

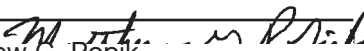

Matthew G. Popik
Vice President of Engineering

PORTER-CABLE
PROFESSIONAL POWER TOOLS

IMPORTANT SAFETY INSTRUCTIONS

WARNING: When using pneumatic tools, basic safety precautions should always be followed to reduce the risk of personal injury, including the following:

READ AND FOLLOW ALL INSTRUCTIONS.

There are certain applications for which this tool was designed. Porter-Cable strongly recommends that this tool NOT be modified and/or used for any application other than for which it was designed. If you have any questions relative to its application DO NOT use the tool until you have written Porter-Cable and we have advised you.

Technical Service Manager
Porter-Cable Corporation
4825 Highway 45 North
P. O. Box 2468
Jackson, TN 38302-2468

1. USE SAFETY GLASSES. To prevent eye injuries, the tool operator and all persons in the work area must wear safety glasses with permanently attached, rigid, plastic side shields. These safety glasses must conform to ANSI Z87.1 requirements (approved glasses have "Z87" printed or stamped on them). Fig. 1.

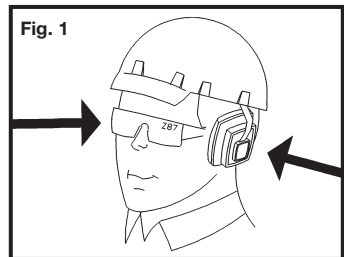

2. WEAR EAR PROTECTION to safeguard against possible hearing loss. Fig. 1.

3. USE CLEAN, DRY, REGULATED compressed air at 70 to 120 PSI, (4.8 to 8.3 BAR). Fig. 2.

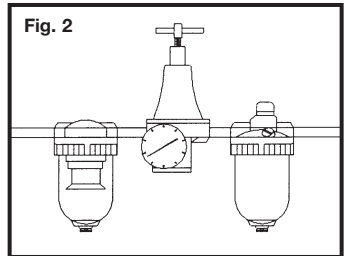

4. DO NOT CONNECT TOOL TO pressure which potentially exceeds 200 PSI (13.7 BAR).

5. ONLY USE AIR HOSE THAT IS RATED for a maximum working pressure of 150 PSI or 150% of the maximum system pressure, which ever is greater.

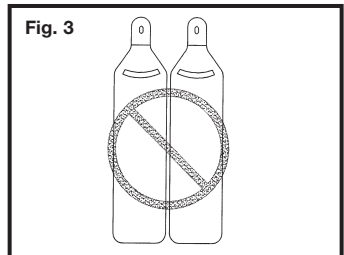

6. NEVER USE OXYGEN, CARBON DIOXIDE, combustible gases or any other bottled gas as a power source for this tool: explosion and serious personal injury could result. Fig. 3.

7. CONNECT TOOL TO AIR SUPPLY HOSE with a coupling that removes all pressure from the tool when the coupling is disconnected. Fig. 4.

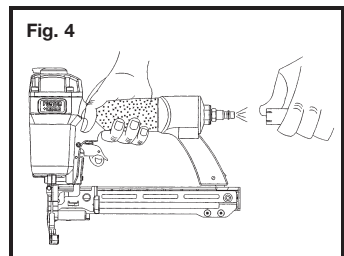

8. DISCONNECT TOOL FROM AIR SUPPLY HOSE before doing tool maintenance, clearing a jammed fastener, leaving work area, moving tool to another location, or handing the tool to another person. Fig. 5.

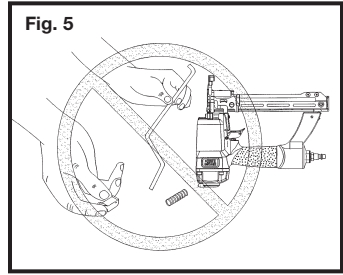

9. NEVER USE A TOOL that is leaking air, has missing or damaged parts, or requires repair. Make sure all screws and caps are securely tightened. Fig. 5.

10. NEVER USE TOOL IF SAFETY, trigger or springs are inoperable, missing or damaged. Do not alter or remove safety, trigger, or springs. Make daily inspections for free movement of trigger and safety mechanism. Fig. 5.

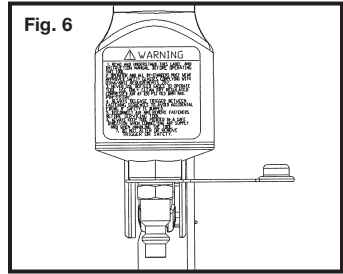

11. DO NOT USE TOOL WITHOUT SAFETY WARNING LABEL. If label is missing, damaged or unreadable, contact your Porter-Cable Service Center for a replacement. Fig. 6.

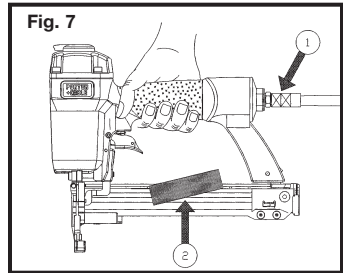

12. ONLY USE PARTS, FASTENERS, AND ACCESSORIES recommended by Porter-Cable. Fig. 7.

13. CONNECT TOOL TO AIR SUPPLY BEFORE loading fasteners, to prevent a fastener from being fired during connection. The tool driving mechanism may cycle when tool is connected to the air supply. Fig. 8.

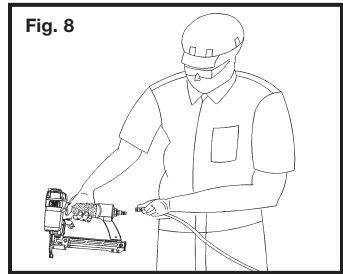

14. ALWAYS ASSUME THE TOOL CONTAINS FASTENERS. Keep the tool pointed away from yourself and others at all times. No horseplay. Respect the tool as a working implement.

15. DO NOT LOAD FASTENERS with trigger or safety depressed, to prevent unintentional firing of a fastener. Fig. 9.

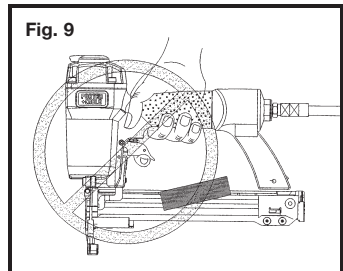

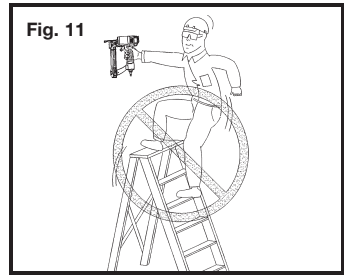
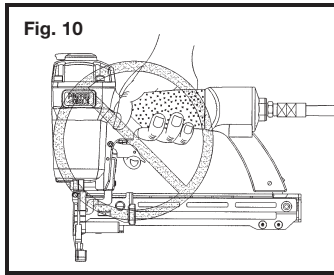

16. REMOVE FINGER FROM TRIGGER when not driving fasteners. Never carry tool with finger on trigger: tool may fire a fastener if safety is bumped while trigger is depressed. Fig. 10.

17. DON'T OVERREACH. Keep proper footing and balance at all times when using or handling the tool. Fig. 11.

18. FIRE FASTENERS INTO WORK SURFACE ONLY: never into materials too hard to penetrate. Fig. 12.

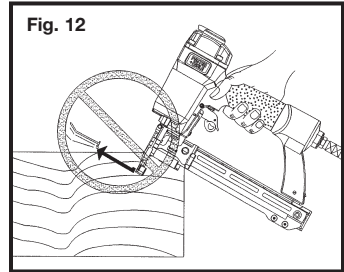

19. GRIP TOOL FIRMLY TO MAINTAIN CONTROL WHILE allowing tool to recoil away from work surface as fastener is driven. If safety element is allowed to recontact work surface before trigger is released, an unwanted fastener may be fired.

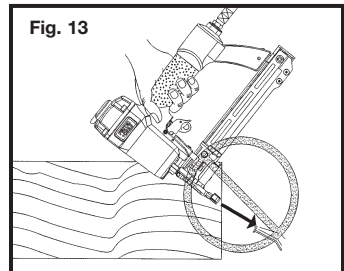

20. DO NOT DRIVE FASTENERS on top of other fasteners, or with the tool at too steep an angle: the fasteners can ricochet causing personal injury. Fig. 13.

21. DO NOT DRIVE FASTENERS CLOSE to the edge of the workpiece. The workpiece is likely to split allowing the fastener to fly free or ricochet causing personal injury. Fig. 13.

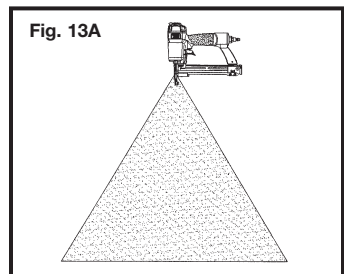

22. KEEP HANDS AND BODY PARTS away from area shown in Fig. 13A, to avoid injury.

23. DO NOT USE ON SCAFFOLDINGS OR LADDERS or for tasks in which changing location involves the use of scaffoldings, stairs, ladders, and the like. Do not use for specific tasks such as closing boxes or crates or fitting transportation safety systems on vehicles and wagons. Fig. 13B.

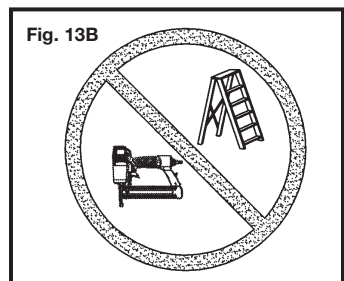

TECHNICAL SPECIFICATIONS

Noise level

A - Weighted sound impulse
power level 99 dBA

P - Emission sound
pressure level 86 dBA

Typical Mean

effective Acceleration 2.5 m/s²

EMPLOYER'S RESPONSIBILITIES

Employer must enforce compliance with the safety warnings and all other instructions contained in this manual.

Keep this manual available for use by all people assigned to use this tool.

For personal safety and proper operation of this tool, read and follow all of these instructions carefully.

OPERATING INSTRUCTIONS

FOREWORD

Porter-Cable Model BN200A is a heavy duty pneumatic brad nailer. It is designed to install 18 ga. brad nails of various lengths (from 3/4" to 2" long), see ACCESSORIES Listing in back of this manual.

CAUTION: Use approved Porter-Cable brad nails only (see ACCESSORIES Listing in back of this manual).

POWER SOURCE

This tool is designed to operate on clean, dry, compressed air at regulated pressures between 70 and 120 PSI (Pounds per Square Inch). The preferred system would include a filter, a pressure regulator, and an automatic oiler located as close to the tool as possible (within 15 feet is ideal).

All compressed air contains moisture and other contaminants that are detrimental to internal components of the tool. An air line filter will remove most of these contaminants and significantly prolong the life of the tool. If an in-line oiler is not available: place five or six drops of Porter-Cable Air Tool Oil (see ACCESSORIES), into the tool's air inlet at the beginning of each workday.

The tool is equipped with a male "quick connector". The tool must always be connected to the air supply with a coupling such that all pressure is removed from the tool when the coupling is disconnected.

CAUTION: All air line components (hoses, connectors, filters, regulators, etc.) must have a minimum working pressure rating of 150 PSI (10.3 BAR) or 150% of maximum system potential, whichever is higher.

Do not connect this tool to a system with maximum potential pressure greater than 200 PSI, (13.7 BAR).

Only connect tool to air supply with a coupling that will release all pressure from the tool when disconnected.

Disconnect tool from air supply before performing maintenance, clearing a jammed fastener, leaving work area, moving tool to another location, or handing the tool to another person.

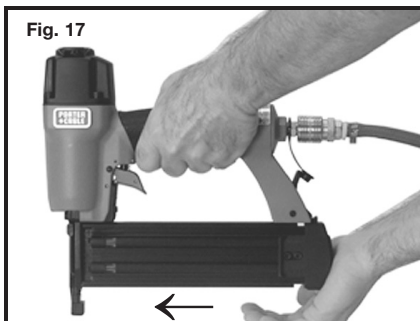
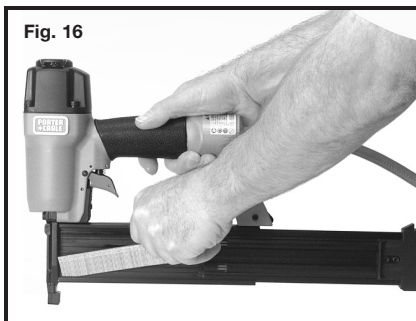
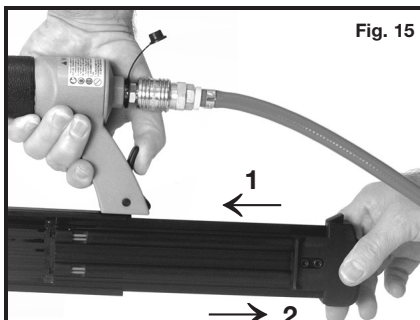

PREPARING THE TOOL

1. After reading and understanding this entire manual, connect tool to air supply.

CAUTION: Keep tool pointed away from yourself and others at all times.

Always connect tool to air supply before loading fasteners.

Do not load fasteners with trigger or safety depressed.

Only use approved Porter-Cable fasteners (see ACCESSORIES).

Always wear Z87 approved safety glasses, and hearing protection when preparing or operating the tool.

Never use a tool that leaks air or needs repair.

2. Depress latch and slide magazine cover open, see Fig. 15.

3. Insert a strip of approved fasteners, see Fig. 16. Orient fasteners with points down, and in contact with the bottom of the magazine.

4. Push magazine cover closed, see Fig. 17.

5. Adjust directional exhaust deflector (A) Fig. 18, so that the exhaust air blast will be directed away from the operator. The exhaust deflector provides 8 detented positions for directing the exhaust blast away from the operator. Grasp the deflector and rotate it to the desired position for the current application.

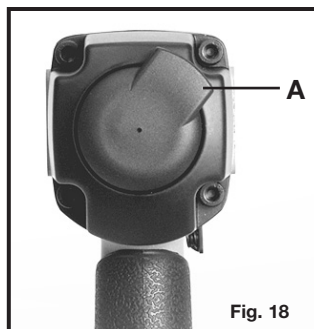

USING THE TOOL

Complete all steps of PREPARING THE TOOL before using the tool.

To fire, grip tool firmly, position nose of tool onto work surface, push forward on tool to depress safety, and squeeze trigger to fire a fastener. This “trigger fire” method provides the most accurate fastener placement. This tool is shipped from the factory with a “restrictive fire trigger” that only allows the tool to be fired this way and is less likely to fire an unwanted fastener.

An alternate “bottom fire trigger” is available. The “bottom fire” trigger allows the tool to be fired in two different ways.

1. The tool can be fired using the “trigger fire” method described above.

OR

2. Grip tool firmly, depress and hold trigger while pushing the tool firmly against work surface. The tool will fire a fastener each time the safety is depressed. This method is known as “bottom fire” and allows very fast repetitive fastener placement.

The “bottom fire trigger” is available free-of-charge by calling 1-800-321-9443 in the United States and Canada or 001-901-660-9374 outside the United States and Canada, and providing tool model and serial number. For identification purposes: the Bottom Fire Trigger is black and the Restrictive Fire Trigger is red.

CAUTION: Remove finger from trigger when not driving fasteners. Never carry tool with finger on trigger: tool may fire a fastener if safety is bumped.

Keep tool pointed in a safe direction at all times.

Never attempt to drive a fastener into material that is too hard, or at too steep an angle, or near the edge of the workpiece. The fastener can ricochet causing personal injury.

Disconnect tool from air supply before performing maintenance, clearing a jammed fastener, leaving work area, moving tool to another location, or handing the tool to another person.

Clean and inspect tool daily. Carefully check for proper operation of trigger and safety mechanism. **Do Not** use the tool unless both the trigger and the safety mechanism are functional, or if the tool is leaking air or needs any other repair.

The depth to which a fastener is driven is controlled by the depth adjustment knob (A) Fig. 19. The depth of drive is factory adjusted to a nominal setting. Test fire a fastener and check depth. If a change is desired, rotate the adjustment knob (A) Fig. 19: the adjustment knob has detents every $\frac{1}{4}$ turn. Rotate the knob clockwise (see Fig. 19), to increase the depth of drive,

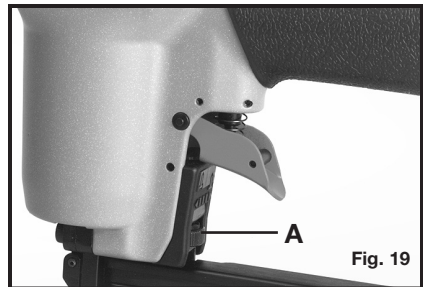

rotate the knob counterclockwise to decrease the depth of drive. Test fire another fastener and check depth. Repeat as necessary to achieve desired results. The amount of air pressure required will vary depending on the size of the fastener and the material being fastened. Experiment with the air pressure setting to determine the lowest setting that will consistently perform the job at hand. Air pressure in excess of that required can cause premature wear and/or damage to the tool.



Fig. 20

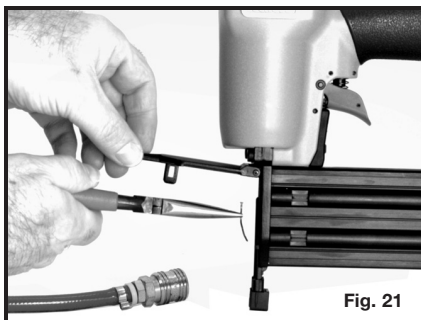

Fig. 21

CLEARING A JAMMED FASTENER

1. **CAUTION:** Disconnect tool from air supply.
2. Open magazine and remove any remaining fasteners.
CAUTION: Remove fasteners from tool before opening the fastener guide plate. Fasteners are under pressure and may shoot out of magazine which could cause injury.
3. Depress the quick release latch and open the fastener guide plate (see Fig. 20).
4. Remove the jammed fastener (see Fig. 21).
5. Depress the quick release latch, close the fastener guide plate, and release the latch.

NOSE CUSHION

This tool is equipped with a rubber nose cushion (A) Fig. 22, that prevents marring of finished surfaces by the metal safety during normal operation. The nose cushion can be removed and stored in the rear area of the magazine (B) Fig. 22, when it is not required.

CAUTION: Disconnect tool from air supply before removing or reinstalling rubber nose cushion.

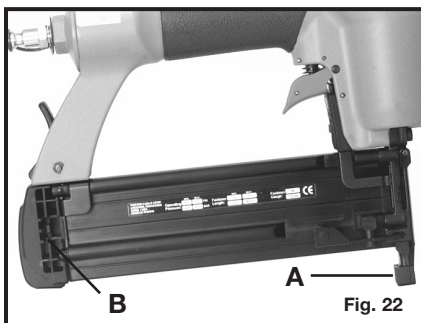

Fig. 22

MAINTENANCE

CLEAN AND INSPECT DAILY

CAUTION: Disconnect tool from air supply before cleaning and inspection. Correct all problems before placing the tool back in use.

Wipe tool clean and inspect for wear or damage. Use non-flammable cleaning solutions to wipe exterior of tool only if necessary. DO NOT SOAK tool with cleaning solutions. Such solutions can damage internal parts.

Inspect trigger and safety mechanism to assure system is complete and functional: no loose or missing parts, no binding or sticking parts.

Keep all screws tight. Loose screws can cause personal injury or damage tool.

If tool is used without an in-line oiler: place 5 or 6 drops of Porter-Cable Air Tool Oil into the air inlet of the tool at the beginning of each workday.

SERVICE AND REPAIRS

All quality tools eventually require servicing or replacement of parts due to wear from normal use. Some user serviceable components are described in the TROUBLESHOOTING Section. Complete product Service is available from either an AUTHORIZED PORTER-CABLE SERVICE STATION or a PORTER-CABLE SERVICE CENTER. All repairs made by these agencies are fully guaranteed against defective material and workmanship. We cannot guarantee repairs made or attempted by anyone other than these agencies.

Should you have any questions about your tool, feel free to write us at any time. In any communications, please give all information shown on the nameplate of your tool (model number, type, serial number, etc.).

TROUBLESHOOTING

CAUTION: Disconnect tool from air supply before performing any Service Procedure.

SYMPTOM	PROBLEMS	SOLUTIONS
1. Air leak near top of tool or in trigger area.	Loose screws. Worn or damaged o-rings or seals.	Tighten screws. Install "OVERHAUL" Maintenance Kit.
2. Tool does nothing or operates sluggishly.	Inadequate air supply. Inadequate lubrication. Worn or damaged o-rings or seals.	Verify adequate air supply. Put 5 or 6 drops of oil into air inlet. Install "DRIVER" Maintenance Kit.
3. Air leak near bottom of tool.	Loose screws. Worn or damaged o-rings or bumper.	Tighten screws. Install "OVERHAUL" Maintenance Kit.
4. Tool jams frequently.	Incorrect fasteners. Damaged fasteners. Magazine or nose screws loose. Magazine is dirty. Driver is worn or damaged.	Verify approved fasteners of correct size. Replace w/undamaged fasteners. Tighten screws. Clean magazine. Install "DRIVER" Maintenance Kit.
5. Other.		Contact a Porter-Cable Service Facility.

ACCESSORIES

The testing of this tool has been accomplished with the following accessories. For safest operation, it is recommended that only these accessories be used with this product.

WARNING: Since accessories other than those listed have not been tested with this product, use of such accessories could be hazardous.

CATALOG NO.	DESCRIPTION	LENGTH	GAUGE	QUAN/BOX
BN18075	18 Ga. Brad Nail, $\frac{3}{4}$ "	$\frac{3}{4}$ "	18	5000
BN18075-1	1000 Pk. of BN18075	$\frac{3}{4}$ "	18	1000
BN18100	18 Ga. Brad Nail, 1"	1"	18	5000
BN18100-1	1000 Pk. of BN18100		18	1000
BN18119	18 Ga. Brad Nail, $1\frac{3}{16}$ "	$1\frac{3}{16}$ "	18	5000
BN18125	18 Ga. Brad Nail, $1\frac{1}{4}$ "	$1\frac{1}{4}$ "	18	5000
BN18125-1	1000 Pk. of BN18125		18	1000
BN18150	18 Ga. Brad Nail, $1\frac{1}{2}$ "	$1\frac{1}{2}$ "	18	5000
BN18156	18 Ga. Brad Nail, $1\frac{9}{16}$ "	$1\frac{9}{16}$ "	18	5000
BN18175	18 Ga. Brad Nail, $1\frac{3}{4}$ "	$1\frac{3}{4}$ "	18	5000
BN18200	18 Ga. Brad Nail, 2"	2"	18	5000
60061	"OVERHAUL" Maintenance Kit			
60063	"DRIVER" Maintenance Kit			
884293	Oil (for Air Tools)			
893579	Safety Glasses			
893933	Bottom Fire Trigger			

PORTER-CABLE LIMITED ONE YEAR WARRANTY

Porter-Cable warrants its nailing and stapling tools for a period of one year from the date of original purchase. We will repair or replace at our option, any part or parts of the product and accessories covered under this warranty which, after examination, proves to be defective in workmanship or material during the warranty period. For repair or replacement return the complete tool or accessory, transportation prepaid, to your nearest Porter-Cable Service Center or Authorized Service Station. Proof of purchase may be required. This warranty does not apply to O-rings and Driver Blades or to repair or replacement required due to misuse, abuse, normal wear and tear or repairs attempted or made by other than our Service Centers or Authorized Service Stations.

ANY IMPLIED WARRANTY, INCLUDING THE IMPLIED WARRANTIES OF MERCHANTABILITY AND FITNESS FOR A PARTICULAR PURPOSE, WILL LAST ONLY FOR ONE (1) YEAR FROM THE DATE OF PURCHASE.

To obtain information on warranty performance please write to: PORTER-CABLE CORPORATION, 4825 Highway 45 North, P.O. Box 2468, Jackson, Tennessee 38302-2468; Attention: Product Service. THE FOREGOING OBLIGATION IS PORTER-CABLE'S SOLE LIABILITY UNDER THIS OR ANY IMPLIED WARRANTY AND UNDER NO CIRCUMSTANCES SHALL PORTER-CABLE BE LIABLE FOR ANY INCIDENTAL OR CONSEQUENTIAL DAMAGES. Some states do not allow limitations on how long an implied warranty lasts or the exclusion or limitation of incidental or consequential damages, so the above limitation or exclusion may not apply to you.

This warranty gives you specific legal rights and you may also have other legal rights which vary from state to state.

PORTER-CABLE SERVICE CENTERS (CENTROS DE SERVICIO DE PORTER-CABLE) (CENTRE DE SERVICE PORTER-CABLE)

Parts and Repair Service for Porter-Cable Power Tools are Available at These Locations
(Obtenga Refaccion de Partes o Servicio para su Herramienta en los Sigüientes Centros de Porter-Cable)
(Locations où vous trouverez les pièces de rechange nécessaires ainsi qu'un service d'entretien)

ARIZONA

Tempe 85282 (Phoenix)
2400 West Southern Avenue
Suite 105
Phone: (602) 437-1200
Fax: (602) 437-2200

CALIFORNIA

Ontario 91761 (Los Angeles)
3949A East Guasti Road
Phone: (909) 390-5555
Fax: (909) 390-5554

San Leandro 94577 (Oakland)
3039 Teagarden Street
Phone: (510) 357-9762
Fax: (510) 357-7939

COLORADO

Denver 80216
5855 Stapleton Drive North
Suite A-140
Phone: (303) 370-6909
Fax: (303) 370-6969

FLORIDA

Davie 33314 (Miami)
4343 South State Rd. 7 (441)
Unit #107
Phone: (954) 321-6635
Fax: (954) 321-6638

Tampa 33609
4538 W. Kennedy Boulevard
Phone: (813) 877-9585
Fax: (813) 289-7948

GEORGIA

Forest Park 30297 (Atlanta)
5442 Frontage Road, Suite 112
Phone: (404) 608-0006
Fax: (404) 608-1123

ILLINOIS

Addison 60101 (Chicago)
311 Laura Drive
Phone: (630) 628-6100
Fax: (630) 628-0023

Woodridge 60517 (Chicago)
2033 West 75th Street
Phone: (630) 910-9200
Fax: (630) 910-0360

MARYLAND

Elkridge 21075 (Baltimore)
7397-102 Washington Blvd.
Phone: (410) 799-9394
Fax: (410) 799-9398

MASSACHUSETTS

Braintree 02185 (Boston)
719 Granite Street
Phone: (781) 848-9810
Fax: (781) 848-6759

Franklin 02038 (Boston)
Franklin Industrial Park
101E Constitution Blvd.
Phone: (508) 520-8802
Fax: (508) 528-8089

MICHIGAN

Troy 48083 (Detroit)
1355 Combermere
Phone: (248) 597-5000
Fax: (248) 597-5004

MINNESOTA

Minneapolis 55429
4315 68th Avenue North
Phone: (612) 561-9080
Fax: (612) 561-0653

MISSOURI

North Kansas City 64116
1141 Swift Avenue
P.O. Box 12393
Phone: (816) 221-2070
Fax: (816) 221-2897

St. Louis 63119
7574 Watson Road
Phone: (314) 968-8950
Fax: (314) 968-2790

NEW YORK

Flushing 11365-1595 (N.Y.C.)
175-25 Horace Harding Expwy.
Phone: (718) 225-2040
Fax: (718) 423-9619

NORTH CAROLINA

Charlotte 28209
4303-B South Boulevard
Phone: (704) 525-4410
Fax: (704) 525-0618

OHIO

Columbus 43214
4560 Indianola Avenue
Phone: (614) 263-0929
Fax: (614) 263-1238

Cleveland 44125
8001 Sweet Valley Drive
Unit #19
Phone: (216) 447-9030
Fax: (216) 447-3097

PENNSYLVANIA

Willow Grove 19090
520 North York Road
Phone: (215) 658-1430
Fax: (215) 658-1433

TENNESSEE

Nashville 37214
2262 Lebanon Pike
Phone: (615) 882-0320
Fax: (615) 882-0051

TEXAS

Dallas 75220
10720 N. Stemmons Freeway
Phone: (214) 353-2996
Fax: (214) 350-3943

Houston 77055
West 10 Business Center
1008 Wirt Road, Suite 120
Phone: (713) 682-0334
Fax: (713) 682-4867

WASHINGTON

Renton 98055 (Seattle)
268 Southwest 43rd Street
Phone: (425) 251-6680
Fax: (425) 251-9337

Authorized Service Stations are located in many large cities. Telephone **800-487-8665** or **901-541-6042** for assistance locating one. Parts and accessories for Porter-Cable products should be obtained by contacting any Porter-Cable Distributor, Authorized Service Center, or Porter-Cable Factory Service Center. If you do not have access to any of these, call **888-848-5175** and you will be directed to the nearest Porter-Cable Factory Service Center. Las Estaciones de Servicio Autorizadas están ubicadas en muchas grandes ciudades. Llame al **800-487-8665** ó al **901-541-6042** para obtener asistencia a fin de localizar una. Las piezas y los accesorios para los productos Porter-Cable deben obtenerse poniéndose en contacto con cualquier distribuidor Porter-Cable, Centro de Servicio Autorizado o Centro de Servicio de Fábrica Porter-Cable. Si no tiene acceso a ninguna de estas opciones, llame al **888-848-5175** y le dirigirá al Centro de Servicio de Fábrica Porter-Cable más cercano. Des centres de service agréés sont situés dans beaucoup de grandes villes. Appelez au **800-487-8665** ou au **901-541-6042** pour obtenir de l'aide pour en repérer un. Pour obtenir des pièces et accessoires pour les produits Porter-Cable, s'adresser à tout distributeur Porter-Cable, centre de service agréé ou centre de service d'usine Porter-Cable. Si vous n'avez accès à aucun de ces centres, appeler le **888-848-5175** et on vous dirigera vers le centre de service d'usine Porter-Cable le plus proche.

DELTA SERVICE CENTERS

ALBERTA

Bay 6, 2520-23rd St. N.E.
Calgary, Alberta
T2E 8L2
Phone: (403) 735-6166
Fax: (403) 735-6144

BRITISH COLUMBIA

8520 Baxter Place
Burnaby, B.C.
V5A 4T8
Phone: (604) 420-0102
Fax: (604) 420-3522

MANITOBA

1699 Dublin Avenue
Winnipeg, Manitoba
R3H 0H2
Phone: (204) 633-9259
Fax: (204) 632-1976

ONTARIO

505 Southgate Drive
Guelph, Ontario
N1H 6M7
Phone: (519) 836-2840
Fax: (519) 767-4131

QUÉBEC

1515 ave.
St-Jean Baptiste,
Québec, Québec
G2E 5E2
Phone: (418) 877-7112
Fax: (418) 877-7123

1447, Begin
St-Laurent, (Montréal), Québec
H4R 1V8
Phone: (514) 336-8772
Fax: (514) 336-3505

The following are trademarks of PORTER-CABLE Corporation (Las siguientes son marcas registradas de PORTER-CABLE S.A.) (Les marques suivantes sont des marques de fabricant de la PORTER-CABLE Corporation): BMMEM®, LASERLOC®, OMNJIIG®, POCKET CUTTER®, PORTA-BAND®, PORTA-PLANE®, PORTER-CABLE®, QUICKSAND®, SANDTRAP®, SAW BOSS®, SPEED-BLOC®, SPEEDMATIC®, SPEEDTRONIC®, STAIR-EASE®, THE PROFESSIONAL EDGE®, THE PROFESSIONAL SELECT®, TIGER CUB®, TIGER SAW®, TORQ-BUSTER®, VERSA-PLANE®, WHISPER SERIES®, DURATRAC™, FRAME SAW™, INNOVATION THAT WORKS™, JETSTREAM™, MICRO-SET™, MORTEN™, NETWORK™, RIPTIDE™, TRU-MATCH™, WOODWORKER'S CHOICE™.

Trademarks noted with ® are registered in the United States Patent and Trademark Office and may also be registered in other countries. Las Marcas Registradas con el signo de ® son registradas por la Oficina de Registros y Patentes de los Estados Unidos y también pueden estar registradas en otros países. Marques déposées, indiquées par la lettre ®, sont déposées au Bureau des brevets d'invention et marques déposées aux Etats-Unis et pourraient être déposées aux autres pays.

Free Manuals Download Website

<http://myh66.com>

<http://usermanuals.us>

<http://www.somanuals.com>

<http://www.4manuals.cc>

<http://www.manual-lib.com>

<http://www.404manual.com>

<http://www.luxmanual.com>

<http://aubethermostatmanual.com>

Golf course search by state

<http://golfingnear.com>

Email search by domain

<http://emailbydomain.com>

Auto manuals search

<http://auto.somanuals.com>

TV manuals search

<http://tv.somanuals.com>