

ESPAÑOL: PÁGINA 13
FRANÇAISE : PAGE 23

Instruction manual

FINISH NAILER

MODEL DA250A



To learn more about Porter-Cable
visit our website at:

<http://www.porter-cable.com>

PORTER-CABLE
PROFESSIONAL POWER TOOLS

Copyright © 2001 Porter-Cable Corporation

IMPORTANT

Please make certain that the person who is to use this equipment carefully reads and understands these instructions before starting operations.

The Model and Serial No. plate is located on the main housing of the tool. Record these numbers in the spaces below and retain for future reference.

Model No. _____

Type _____

Serial No. _____

Part No. 903090 (016)



PORTER+CABLE
Porter-Cable Corporation
4825 Highway 45 North
Jackson, TN 38305

GB ENGLISH

EC-DECLARATION OF CONFORMITY

We declare under our sole responsibility that this product is in conformity with the regulations 89/392/EEC; 73/23/EEC; 89/336/EEC.

E ESPANOL

DECLARACION DE CONFORMIDAD "CE"

Declaramos bajo nuestra sola responsabilidad que este producto está en conformidad con las regulaciones 89/392/CE; 73/23/CE; 89/336/CE.

F FRANÇAISE

DÉCLARATION DE CONFORMITÉ CE

Nous déclarons sous notre propre responsabilité que ce produit est conforme aux réglementations 89/392/CEE; 73/23/CEE; 89/336/CEE.

Matthew G. Popik
Vice President of Engineering



Date of Manufacture: _____

Fecha de fabricación:, Date de fabrication:

Serial No: _____

Número de serie:, Nombre d'ordre

GENERAL SAFETY RULES

⚠ WARNING: When using pneumatic tools, basic safety precautions should always be followed to reduce the risk of personal injury, including the following:

READ AND FOLLOW ALL INSTRUCTIONS.

There are certain applications for which this tool was designed. Porter-Cable strongly recommends that this tool NOT be modified and/or used for any application other than for which it was designed. If you have any questions relative to its application DO NOT use the tool until you have written Porter-Cable and we have advised you.

Technical Service Manager
Porter-Cable Corporation
4825 Highway 45 North
Jackson, TN 38305

1. **USE SAFETY GLASSES.** To prevent eye injuries, the tool operator and all persons in the work area must wear safety glasses with permanently attached, rigid, plastic side shields. These safety glasses must conform to ANSI Z87.1 requirements (approved glasses have "Z87" printed or stamped on them). Fig. 1.

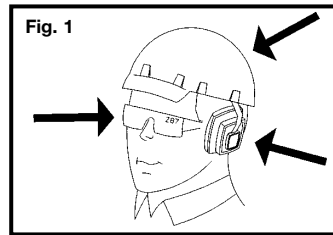

2. **WEAR EAR PROTECTION** to safeguard against possible hearing loss. Fig. 1.

3. **OPERATOR AND BYSTANDERS WEAR HARD HAT** to safeguard against possible injuries. Fig. 1.

4. **USE CLEAN, DRY, REGULATED** compressed air at 70 to 120 PSI, (4.8 to 8.3 BAR). Fig. 2.

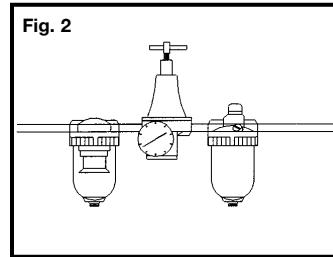

5. **DO NOT CONNECT TOOL** to pressure which potentially exceeds 200 PSI (13.7 BAR).

6. **ONLY USE AIR HOSE THAT IS RATED** for a maximum working pressure of at least 150 PSI (10.3 BAR) or 150% of the maximum system pressure, whichever is greater.

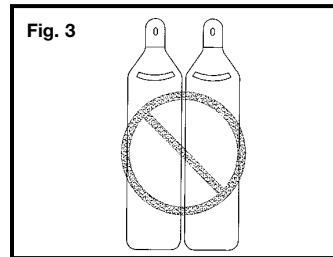

7. **NEVER USE OXYGEN, CARBON DIOXIDE,** combustible gases or any other bottled gas as a power source for this tool: explosion and serious personal injury could result. Fig. 3.

8. **CONNECT TOOL TO AIR SUPPLY HOSE** with a coupling that automatically removes all pressure from the tool when the coupling is disconnected. Fig. 4.

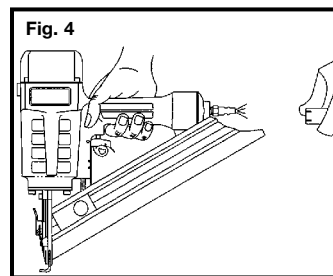

9. DISCONNECT TOOL FROM AIR SUPPLY HOSE before doing tool maintenance, clearing a jammed fastener, leaving work area, moving tool to another location, handing the tool to another person, or making adjustments. Fig. 4.

10. NEVER USE A TOOL that is leaking air, has missing or damaged parts, or requires repair. Make sure all screws and caps are securely tightened. Fig. 5.

11. NEVER USE TOOL IF SAFETY, trigger or springs are inoperable, missing or damaged. Do not alter or remove safety, trigger, or springs. Make daily inspections for free movement of trigger and safety mechanism. Fig. 5.

12. DO NOT USE TOOL WITHOUT SAFETY WARNING LABEL. If label is missing, damaged or unreadable, contact your Porter-Cable Service Center for a replacement. Fig. 6.

13. ONLY USE PARTS, FASTENERS, AND ACCESSORIES recommended by Porter-Cable.

14. REMOVE ALL FASTENERS from tool before connecting to air supply. The tool's driving mechanism may cycle when tool is connected to the air supply. Fig. 7.

15. ALWAYS ASSUME THE TOOL CONTAINS FASTENERS. Keep the tool pointed away from yourself and others at all times. No horseplay. Respect the tool as a working implement. Fig. 8.

16. DO NOT LOAD FASTENERS with trigger or safety depressed, to prevent unintentional firing of a fastener. Fig. 9.

17. REMOVE FINGER FROM TRIGGER when not driving fasteners. Never carry tool with finger on trigger. Tool will fire a fastener if safety is bumped while trigger is depressed. Fig. 10.

18. DON'T OVERREACH. Keep proper footing and balance at all times when using or handling the tool.

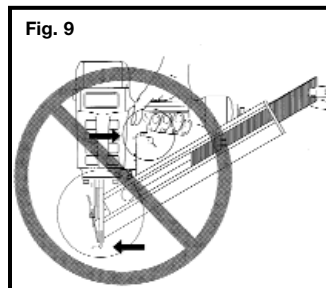
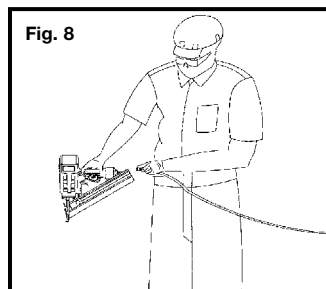
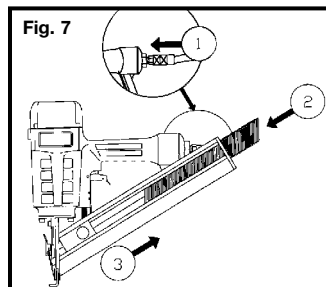
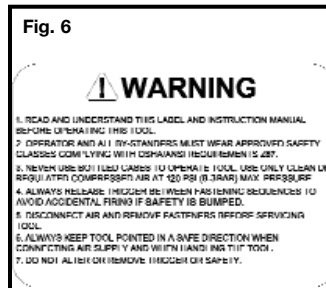
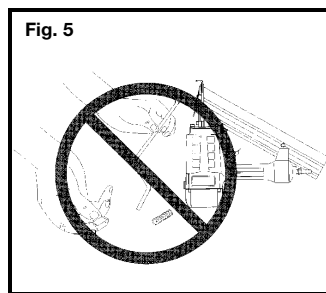

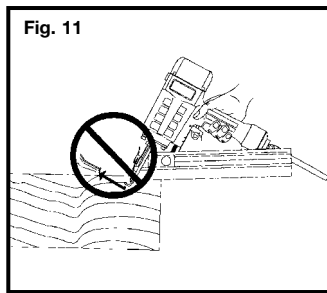
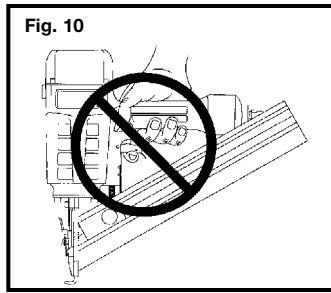

19. FIRE FASTENERS INTO WORK SURFACE ONLY, never into materials too hard to penetrate. Fig. 11.

20. GRIP TOOL FIRMLY TO MAINTAIN CONTROL WHILE allowing tool to recoil away from work surface as fastener is driven. If safety element is allowed to recontact work surface before trigger is released an unwanted fastener will be fired.

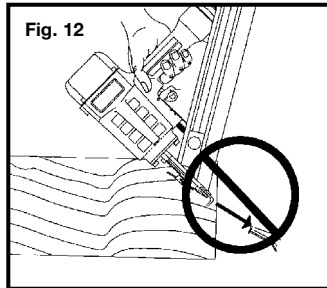

21. DO NOT DRIVE FASTENERS on top of other fasteners, or with the tool at too steep an angle: the fasteners can ricochet causing personal injury. Fig. 12.

22. DO NOT DRIVE FASTENERS CLOSE to the edge of the workpiece. The workpiece is likely to split allowing the fastener to fly free or ricochet causing personal injury. Fig. 12.

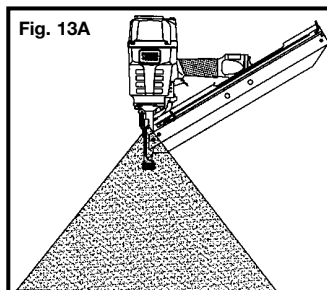

23. KEEP HANDS AND BODY PARTS away from area shown in Fig. 13A, to avoid injury.

24. DO NOT USE ON SCAFFOLDINGS OR LADDERS or for tasks in which changing location involves the use of scaffoldings, stairs, ladders, and the like. Do not use for specific tasks such as closing boxes or crates or fitting transportation safety systems on vehicles and wagons. Fig. 13B.

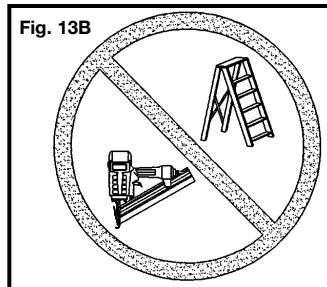

TECHNICAL SPECIFICATIONS

Noise level	Typical Mean
A - Weighted sound impulse power level 95.1 dBA	effective Acceleration . . .3.91 m/s ²
P - Emission sound pressure pressure level . . . 86.3 dBA	

EMPLOYER'S RESPONSIBILITIES

 **WARNING:** Employer must enforce compliance with the safety warnings and all other instructions contained in this manual.

Keep this manual available for use by all people assigned to use this tool.

For personal safety and proper operation of this tool, read and follow all of these instructions carefully.

OPERATING INSTRUCTIONS

FOREWORD

Porter-Cable Model DA250A is a heavy duty pneumatic finish nailer. It is designed to install 15 ga. finish nails of various lengths (from 1 $\frac{1}{4}$ " to 2 $\frac{1}{2}$ " long), see ACCESSORIES Listing in back of this manual.

CAUTION: Use approved Porter-Cable finish nails only (see ACCESSORIES Listing in back of this manual).

POWER SOURCE

This tool is designed to operate on clean, dry, compressed air at regulated pressures between 70 and 120 PSI (Pounds per Square Inch)(4.8 to 8.3 BAR). The preferred system would include a filter, a pressure regulator, and an automatic oiler located as close to the tool as possible (within 15 ft/4.6 m is ideal).

All compressed air contains moisture and other contaminants that are detrimental to internal components of the tool. An air line filter will remove most of these contaminants and significantly prolong the life of the tool. If an in-line oiler is not available: place five or six drops of Porter-Cable Air Tool Oil (see ACCESSORIES), into the tool's air inlet at the beginning of each workday.

The tool is equipped with a $\frac{1}{4}$ " male "quick connector". A $\frac{3}{8}$ " male "quick connector" is available from Porter-Cable and may be used in situations where a $\frac{1}{4}$ " supply line is not available. A $\frac{3}{8}$ " supply line (and fittings) are required for maximum tool performance. The tool must always be connected to the air supply with a coupling such that all pressure is removed from the tool when the coupling is disconnected.

 **WARNING:** All air line components (hoses, connectors, filters, regulators, etc.) must have a minimum working pressure rating of at least 150 PSI (10.3 BAR) or 150% of maximum system potential, whichever is higher.

Do not connect this tool to a system with maximum potential pressure greater than 200 PSI (13.7 BAR).

Only connect tool to air supply with a coupling that will automatically release all pressure from the tool when disconnected.

Disconnect tool from air supply before performing maintenance, clearing a jammed fastener, leaving work area, moving tool to another location, or handing the tool to another person.

PREPARING THE TOOL

1. After reading and understanding this entire manual, connect tool to air supply.

⚠ WARNING: Keep tool pointed away from yourself and others at all times.

Always connect tool to air supply before loading fasteners.(see Fig. 14).

Do not load fasteners with trigger or safety depressed.

Only use approved Porter-Cable fasteners (see ACCESSORIES).

Always wear ANSI Z87.1 approved safety glasses, and hearing protection when preparing or operating the tool.

Never use a tool that leaks air or needs repair.

2. Orient a strip of nails with points down (see Fig. 15), and align with the magazine "T" slot.

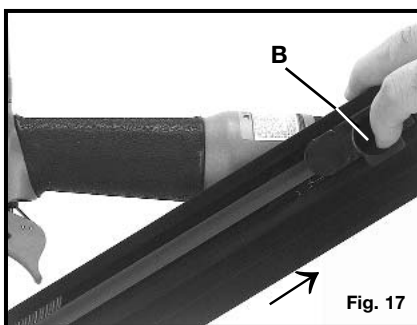
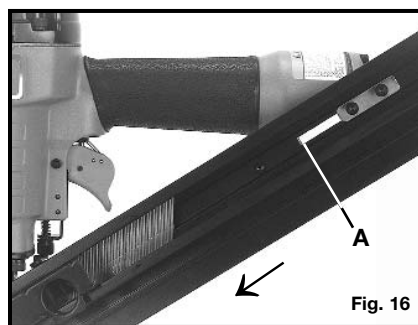
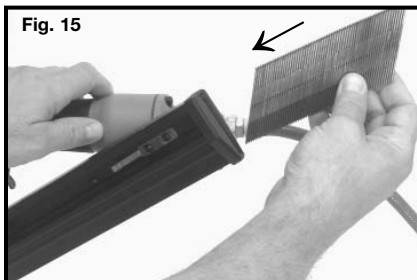
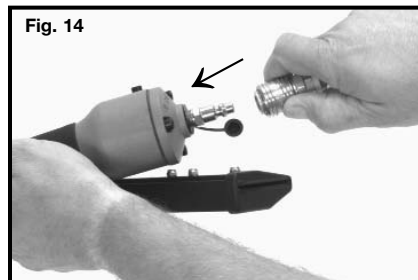

3. Feed the strip of nails into the magazine ("T" slot), until they are past the stop (A) Fig. 16.

4. Pull the follower (B) Fig. 17, all the way to the rear of the magazine and release. The follower will apply pressure to the strip of nails to feed it into the driving mechanism.

5. Adjust directional exhaust deflector (A) Fig. 18, so that the exhaust air blast will be directed away from the operator. The exhaust deflector provides seven detented positions for directing the exhaust blast away from the operator. Grasp the deflector and rotate it to the desired position for the current application.

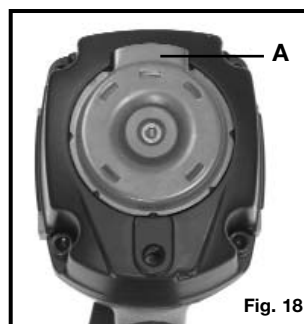

USING THE TOOL

Complete all steps of PREPARING THE TOOL before using the tool.

To fire, grip tool firmly, position nose of tool onto work surface, push forward on tool to depress safety, and squeeze trigger to fire a fastener. This “trigger fire” method provides the most accurate fastener placement. This tool is shipped from the factory with a “restrictive fire trigger” that only allows the tool to be fired this way and is less likely to fire an unwanted fastener.

An alternate “bottom fire trigger” is available. The “bottom fire” trigger allows the tool to be fired in two different ways.

1. The tool can be fired using the “trigger fire” method described above.

OR

2. Grip tool firmly, depress and hold trigger while pushing the tool firmly against work surface. The tool will fire a fastener each time the safety is depressed. This method is known as “bottom fire” and allows very fast repetitive fastener placement.

The “bottom fire trigger” is available free-of-charge by calling 1-800-321-9443 in the United States and Canada or 001-731-660-9374 outside the United States and Canada, and providing tool model and serial number. For identification purposes: the Bottom Fire Trigger is black and the Restrictive Fire Trigger is red.

⚠ WARNING: Remove finger from trigger when not driving fasteners. Never carry tool with finger on trigger: tool will fire a fastener if safety is bumped.

⚠ WARNING: Keep tool pointed in a safe direction at all times.

⚠ WARNING: Never attempt to drive a fastener into material that is too hard, or at too steep an angle, or near the edge of the workpiece. The fastener can ricochet causing personal injury.

⚠ WARNING: Disconnect tool from air supply before performing maintenance, clearing a jammed fastener, leaving work area, moving tool to another location, or handing the tool to another person.

⚠ WARNING: Clean and inspect tool daily. Carefully check for proper operation of trigger and safety mechanism. **Do Not** use the tool unless both the trigger and the safety mechanism are functional, or if the tool is leaking air or needs any other repair.

The depth to which a fastener is driven is controlled by the depth adjustment knob (A) Fig. 19. The depth of drive is factory adjusted to a nominal setting. Test fire a fastener and check depth. If a change is desired, rotate the adjustment knob (A) Fig. 19: the adjustment knob has detents every $\frac{1}{4}$ turn. Rotate the knob clockwise (see Fig. 19), to increase the depth of drive, rotate the knob counterclockwise to decrease the depth of drive. Test fire another fastener and check depth. Repeat as necessary to achieve desired results. The amount of air pressure required will vary depending on the size of the fastener and the material being fastened.

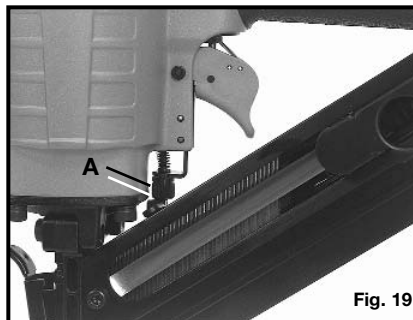

Fig. 19

Experiment with the air pressure setting to determine the lowest setting that will consistently perform the job at hand. Air pressure in excess of that required can cause premature wear and/or damage to the tool.

A rubber nose cushion (A) Fig. 22, is provided to reduce marring of the work surface. The rubber cushion can be pulled off to provide increased depth-of-drive for toe-nailing applications.

⚠ WARNING: Disconnect tool from air supply before removing or re-installing rubber cushion.

CLEARING A JAMMED FASTENER

1. **⚠ WARNING:** Disconnect tool from air supply.
2. Remove any remaining fasteners from the nailer.
 - A. Place finger through hole (A) Fig. 20, and push lever to release follower mechanism.
 - B. Slide the follower to the left end of the magazine.
 - C. Depress the stop (B) Fig. 21, and slide all remaining fasteners out of the magazine.
3. Open the quick release latch and hinge the fastener guide plate open (B) Fig. 22.
4. Remove the jammed fastener (see Fig. 23).
5. Close the fastener guide plate and secure with the quick release latch.

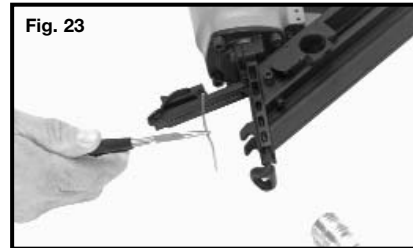
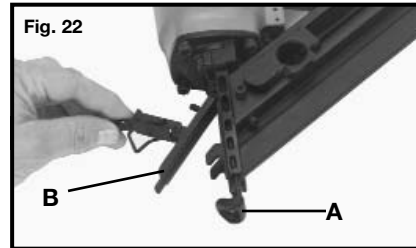
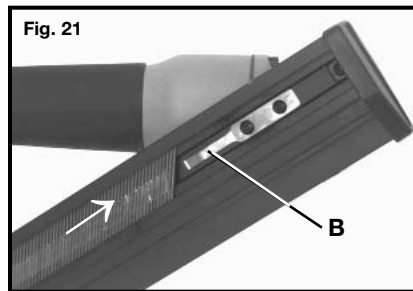
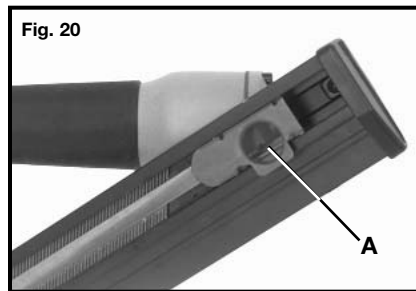

MAINTENANCE

CLEAN AND INSPECT DAILY

⚠ WARNING: Disconnect tool from air supply before cleaning and inspection. Correct all problems before placing the tool back in use.

Wipe tool clean and inspect for wear or damage. Use non-flammable cleaning solutions to wipe exterior of tool only if necessary. DO NOT SOAK tool with cleaning solutions. Such solutions can damage internal parts.

Inspect trigger and safety mechanism to assure system is complete and functional: no loose or missing parts, no binding or sticking parts.

Keep all screws tight. Loose screws can cause personal injury or damage tool.

If tool is used without an in-line oiler: place 5 or 6 drops of Porter-Cable Air Tool Oil into the air inlet of the tool at the beginning of each workday.

SERVICE AND REPAIRS

All quality tools will eventually require servicing or replacement of parts due to wear from normal use. These operations should ONLY be performed by either an AUTHORIZED PORTER-CABLE SERVICE STATION or a PORTER-CABLE/DELTA FACTORY SERVICE CENTER. All repairs made by these agencies are fully guaranteed against defective material and workmanship. We cannot guarantee repairs made or attempted by anyone other than these agencies.

Should you have any questions about your tool, feel free to write us at any time. In any communications, please give all information shown on the nameplate of your tool (model number, type, serial number, etc.).

TROUBLESHOOTING

⚠ WARNING: Disconnect tool from air supply before performing any Service Procedure.

SYMPTOM	PROBLEMS	SOLUTIONS
1. Air leak near top of tool or in trigger area.	Loose screws. Worn or damaged o-rings or seals.	Tighten screws. Install Overhaul Kit.
2. Tool does nothing or operates sluggishly.	Inadequate air supply. Inadequate lubrication. Worn or damaged o-rings or seals.	Verify adequate air supply. Put 5 or 6 drops of oil into air inlet. Install Overhaul Kit.
3. Air leak near bottom of tool.	Loose screws. Worn or damaged o-rings or bumper.	Tighten screws. Install Overhaul Kit.
4. Tool jams frequently.	Incorrect fasteners. Damaged fasteners. Magazine or nose screws loose. Magazine is dirty. Driver is worn or damaged.	Verify approved fasteners of correct size. Replace w/undamaged fasteners. Tighten screws. Clean magazine. Install "DRIVER" Maintenance Kit.
5. Other.		Contact a Porter-Cable Service Facility.

ACCESSORIES

A complete line of accessories is available from your Porter-Cable • Delta Supplier, Porter-Cable • Delta Factory Service Centers, and Porter-Cable Authorized Service Stations. Please visit our Web Site www.porter-cable.com for a catalog or for the name of your nearest supplier.

 **WARNING:** Since accessories other than those offered by Porter-Cable • Delta have not been tested with this product, use of such accessories could be hazardous. For safest operation, only Porter-Cable • Delta recommended accessories should be used with this product.

CATALOG NUMBER	DESCRIPTION	LENGTH	GAUGE	QTY/BOX
DA15125	16 Ga. D/A Nail, 1 ¹ / ₄ "	1 ¹ / ₄ "	15	4000
DA15125-1	1000 Pk. of DA15125		15	1000
DA15150	15 Ga. D/A Nail, 1 ¹ / ₂ "	1 ¹ / ₂ "	15	4000
DA15150-1	1000 Pk. of DA15150		15	1000
DA15175	15 Ga. D/A Nail, 1 ³ / ₄ "	1 ³ / ₄ "	15	4000
DA15175-1	1000 Pk. of DA15175		15	1000
DA15200	15 Ga. D/A Nail, 2"	2"	15	4000
DA15200-1	1000 Pk. of DA15200		15	1000
DA15250	15 Ga. D/A Nail, 2 ¹ / ₂ "	2 ¹ / ₂ "	15	4000
DA15200G	15 Ga. D/A Nail, 2" (Galvanized)	2"	15	4000
DA15250G	15 Ga. D/A Nail, 2 ¹ / ₂ " (Galvanized)	2 ¹ / ₂ "	15	4000
DA15250G-1	1000 Pk of DA15250G		15	1000
60014	Driver Maintenance Kit			
60073	Overhaul Kit			
884293	Oil (for Air Tools)			
883763	Safety Glasses			
893077	Restrictive Fire Trigger			
893930	Bottom Fire Trigger			

PORTER-CABLE LIMITED ONE YEAR WARRANTY

Porter-Cable warrants its nailing and stapling tools for a period of one year from the date of original purchase. We will repair or replace at our option, any part or parts of the product and accessories covered under this warranty which, after examination, proves to be defective in workmanship or material during the warranty period. For repair or replacement return the complete tool or accessory, transportation prepaid, to your nearest Porter-Cable Service Center or Authorized Service Station. Proof of purchase may be required. This warranty does not apply to O-rings and Driver Blades or to repair or replacement required due to misuse, abuse, normal wear and tear or repairs attempted or made by other than our Service Centers or Authorized Service Stations.

ANY IMPLIED WARRANTY, INCLUDING THE IMPLIED WARRANTIES OF MERCHANTABILITY AND FITNESS FOR A PARTICULAR PURPOSE, WILL LAST ONLY FOR ONE (1) YEAR FROM THE DATE OF PURCHASE.

To obtain information on warranty performance please write to: PORTER-CABLE CORPORATION, 4825 Highway 45 North, Jackson, Tennessee 38305; Attention: Product Service. THE FOREGOING OBLIGATION IS PORTER-CABLE'S SOLE LIABILITY UNDER THIS OR ANY IMPLIED WARRANTY AND UNDER NO CIRCUMSTANCES SHALL PORTER-CABLE BE LIABLE FOR ANY INCIDENTAL OR CONSEQUENTIAL DAMAGES. Some states do not allow limitations on how long an implied warranty lasts or the exclusion or limitation of incidental or consequential damages, so the above limitation or exclusion may not apply to you.

This warranty gives you specific legal rights and you may also have other legal rights which vary from state to state.

**PORTER-CABLE • DELTA SERVICE CENTERS
(CENTROS DE SERVICIO DE PORTER-CABLE • DELTA)
(CENTRE DE SERVICE PORTER-CABLE • DELTA)**

**Parts and Repair Service for Porter-Cable • Delta Power Tools are Available at These Locations
(Obtenga Refaccion de Partes o Servicio para su Herramienta en los Sigüientes Centros de Porter-Cable • Delta)
(Locations où vous trouverez les pièces de rechange nécessaires ainsi qu'un service d'entretien)**

ARIZONA Tempe 85282 (Phoenix) 2400 West Southern Avenue Suite 105 Phone: (602) 437-1200 Fax: (602) 437-2200	ILLINOIS Addison 60101 (Chicago) 311 Laura Drive Phone: (630) 628-6100 Fax: (630) 628-0023	MINNESOTA Cleveland 44125 8001 Sweet Valley Drive Unit #19 Phone: (216) 447-9030 Fax: (216) 447-3097	OREGON Portland 97230 4916 NE 122 nd Ave. Phone: (503) 252-0107 Fax: (503) 252-2123
CALIFORNIA Ontario 91761 (Los Angeles) 3949A East Guasti Road Phone: (909) 390-5555 Fax: (909) 390-5554	Woodridge 60517 (Chicago) 2033 West 75th Street Phone: (630) 910-9200 Fax: (630) 910-0360	MISSOURI North Kansas City 64116 1141 Swift Avenue P.O. Box 12393 Phone: (816) 221-2070 Fax: (816) 221-2897	PENNSYLVANIA Willow Grove 19099 520 North York Road Phone: (215) 658-1430 Fax: (215) 658-1433
San Leandro 94577 (Oakland) 3039 Teagarden Street Phone: (510) 357-9762 Fax: (510) 357-7939	MARYLAND Elkridge 21075 (Baltimore) 7397-102 Washington Blvd. Phone: (410) 799-9394 Fax: (410) 799-9398	St. Louis 63119 7574 Watson Road Phone: (314) 968-8950 Fax: (314) 968-2790	TEXAS Carrollton 75006 (Dallas) 1300 Interstate 35 N, Suite 112 Phone: (972) 446-2996 Fax: (972) 446-8157
FLORIDA Davie 33314 (Miami) 4343 South State Rd. 7 (441) Unit #107 Phone: (954) 321-6635 Fax: (954) 321-6638	MASSACHUSETTS Braintree 02185 (Boston) 719 Granite Street Phone: (781) 848-9810 Fax: (781) 848-6759	NEW YORK Flushing 11365-1595 (N.Y.C.) 175-25 Horace Harding Expwy. Phone: (718) 225-2040 Fax: (718) 423-9619	Houston 77055 West 10 Business Center 1008 Wirt Road, Suite 120 Phone: (713) 682-0334 Fax: (713) 682-4867
Tampa 33609 4538 W. Kennedy Boulevard Phone: (813) 877-9585 Fax: (813) 289-7948	Franklin 02038 (Boston) Franklin Industrial Park 101E Constitution Blvd. Phone: (508) 520-8802 Fax: (508) 528-8089	NORTH CAROLINA Charlotte 28270 9129 Monroe Road, Suite 115 Phone: (704) 841-1176 Fax: (704) 708-4625	WASHINGTON Renton 98055 (Seattle) 268 Southwest 43rd Street Phone: (425) 251-6680 Fax: (425) 251-9337
GEORGIA Forest Park 30297 (Atlanta) 5442 Frontage Road, Suite 112 Phone: (404) 608-0006 Fax: (404) 608-1123	MICHIGAN Madison Heights 48071 (Detroit) 30475 Stephenson Highway Phone: (248) 597-5000 Fax: (248) 597-5004	OHIO Columbus 43214 4560 Indianola Avenue Phone: (614) 263-0929 Fax: (614) 263-1238	

Authorized Service Stations are located in many large cities. Telephone **800-487-8665** or **731-541-6042** for assistance locating one. Parts and accessories for Porter-Cable • Delta products should be obtained by contacting any Porter-Cable • Delta Distributor, Authorized Service Center, or Porter-Cable • Delta Factory Service Center. If you do not have access to any of these, call **888-848-5175** and you will be directed to the nearest Porter-Cable • Delta Factory Service Center. Las Estaciones de Servicio Autorizadas están ubicadas en muchas grandes ciudades. Llame al **800-487-8665** ó al **731-541-6042** para obtener asistencia a fin de localizar una. Las piezas y los accesorios para los productos Porter-Cable • Delta deben obtenerse poniéndose en contacto con cualquier distribuidor Porter-Cable • Delta, Centro de Servicio Autorizado o Centro de Servicio de Fábrica Porter-Cable • Delta. Si no tiene acceso a ninguna de estas opciones, llame al **888-848-5175** y le dirigirán al Centro de Servicio de Fábrica Porter-Cable • Delta más cercano. Des centres de service agréés sont situés dans beaucoup de grandes villes. Appelez au **800-487-8665** ou au **731-541-6042** pour obtenir de l'aide pour en réparer un. Pour obtenir des pièces et accessoires pour les produits Porter-Cable • Delta, s'adresser à tout distributeur Porter-Cable • Delta, centre de service agréé ou centre de service d'usine Porter-Cable • Delta. Si vous n'avez accès à aucun de ces centres, appelez le **888-848-5175** et on vous dirigera vers le centre de service d'usine Porter-Cable • Delta le plus proche.

CANADIAN PORTER-CABLE • DELTA SERVICE CENTERS

ALBERTA Bay 6, 2520-23rd St. N.E. Calgary, Alberta T2E 8L2 Phone: (403) 735-6166 Fax: (403) 735-6144	MANITOBA 1699 Dublin Avenue Winnipeg, Manitoba R3H 0H2 Phone: (204) 633-9259 Fax: (204) 632-1976	QUÉBEC 1515 Avenue St-Jean Baptiste, Québec, Québec G2E 5E2 Phone: (418) 877-7112 Fax: (418) 877-7123
BRITISH COLUMBIA 8520 Baxter Place Burnaby, B.C. V5A 4T8 Phone: (604) 420-0102 Fax: (604) 420-3522	ONTARIO 505 Southgate Drive Guelph, Ontario N1H 6M7 Phone: (519) 836-2840 Fax: (519) 767-4131	1447, Begin St-Laurent, (Montréal), Québec H4R 1V8 Phone: (514) 336-8772 Fax: (514) 336-3505

The following are trademarks of PORTER-CABLE • DELTA (Las siguientes son marcas registradas de PORTER-CABLE • DELTA S.A.) (Les marques suivantes sont des marques de fabricant de la PORTER-CABLE • DELTA): BAMMER®, LASERLOC®, OMNIJIG®, POCKET CUTTER®, PORTA-BAND®, PORTA-PLANE®, PORTER-CABLE®, QUICKSAND®, SANDTRAP®, SAW BOSS®, SPEED-BLOC®, SPEEDMATIC®, SPEEDTRONIC®, STAIR-EASE®, THE PROFESSIONAL EDGE®, THE PROFESSIONAL SELECT®, TIGER CUB®, TIGER SAW®, TORQ-BUSTER®, VERSA-PLANE®, WHISPER SERIES®, DURATRONIC™, FRAME SAW™, INNOVATION THAT WORKS™, JETSTREAM™, MICRO-SET™, MORTEN™, NETWORK™, RIPTIDE™, TRU-MATCH™, WOODWORKER'S CHOICE™, THE AMERICAN WOOD SHOP™ (design) , AUTO-SET™, B.O.S.S.™, BUILDER'S SAW™, CONTRACTOR'S SAW™, DELTA™, DELTACRAFT™, HOMECRAFT™, JET-LOCK™, KICKSTAND™, THE LUMBER COMPANY™ (design), MICRO-SET™, Q3™, QUICKSET II™, QUICKSET PLUS™, SAFEGUARD II™, SANDING CENTER™, SIDEKICK™, UNIFENCE™, UNIGUARD™, UNIRIP™, UNISAW™, VERSA-FEEDER™.

Trademarks noted with ™ and ® are registered in the United States Patent and Trademark Office and may also be registered in other countries. Las Marcas Registradas con el signo de ™ y ® son registradas por la Oficina de Registros y Patentes de los Estados Unidos y también pueden estar registradas en otros países. Marques déposées, indiquées par la lettre ™ et ®, sont déposées au Bureau des brevets d'invention et marques déposées aux Etats-Unis et pourraient être déposées aux autres pays.

Printed in U.S.A.

Free Manuals Download Website

<http://myh66.com>

<http://usermanuals.us>

<http://www.somanuals.com>

<http://www.4manuals.cc>

<http://www.manual-lib.com>

<http://www.404manual.com>

<http://www.luxmanual.com>

<http://aubethermostatmanual.com>

Golf course search by state

<http://golfingnear.com>

Email search by domain

<http://emailbydomain.com>

Auto manuals search

<http://auto.somanuals.com>

TV manuals search

<http://tv.somanuals.com>