

Instruction manual

ESPAÑOL: PÁGINA 21
FRANÇAIS: PAGE 41

8 Horsepower 3000 PSI 3 GPM Pressure Washer



PCH3031A

IMPORTANT

Please make certain that the person who is to use this equipment carefully reads and understands these instructions before starting operations.

To learn more about Porter-Cable
visit our website at:

<http://www.porter-cable.com>

PORTER-CABLE
PROFESSIONAL POWER TOOLS

The Model and Serial No. plate is located on the frame. Record these numbers in the spaces below and retain for future reference.

Model No. _____

Type _____

Serial No. _____

GENERAL INFORMATION

- Congratulations! You have purchased a high quality product from America's leading manufacturer of pressure washers. This pressure washer, when properly used and maintained, will provide trouble free service. Please read and follow these instructions for proper use and maintenance.
- All sales of pressure washers are final. **Do not return this product to the retailer. Call 1-888-559-8550.**
- If you experience any problems and need assistance, please call us at our toll free number **1-888-559-8550, Monday through Saturday, 8:00 a.m. To 6:00 p.m. C.S.T.**
- If repair or service part purchase is required, our many Authorized Warranty Service Centers are conveniently located and equipped to handle all in-warranty and out-of-warranty service.
- For the location of the nearest Authorized Warranty Service Center call 1-888-559-8550, Ext. 2, 24 hours a day, 7 days a week.
- All pressure washers carry a manufacturer's one year warranty from date of purchase for consumer use and a 90 day warranty for commercial use.
- Retain sales receipt as proof of purchase for warranty service.
- Do not operate this unit until you have read and understood this Owners Manual for Safety, Operation, and Maintenance Instructions.
- Do not operate this unit until you have read and understood the Engine Owners Manual for Safety, Operation, and Maintenance Instructions.

▲ WARNING Read Operator's Manual. Do not operate equipment until you have read Operator's Manual for Safety, Assembly, Operation, and Maintenance Instructions.

▲ WARNING This product may not be equipped with a spark arresting muffler. If the product is not equipped and will be used around flammable materials, or on land covered with materials such as agricultural crops, forest, brush, grass, or other similar items, then an approved spark arrester must be installed and is legally required in the state of California. It is a violation of California statutes section 130050 and/or sections 4442 and 4443 of the California Public Resources Code, unless the engine is equipped with a spark arrester, as defined in section 4442, and maintained in effective working order. Spark arrester are also required on some U.S. Forest Service land and may also be legally required under other statutes and ordinances.

▲ WARNING Engine exhaust contains chemicals known, in certain quantities, to cause cancer, birth defects or other reproductive harm.



SAFETY GUIDELINES / DEFINITIONS





This manual contains information that is important for you to know and understand. This information relates to protecting YOUR SAFETY and PREVENTING EQUIPMENT PROBLEMS. To help you recognize this information, we use the symbols below. Please read the manual and pay attention to these sections.





- ⚠ DANGER** indicates an imminently hazardous situation which, if not avoided, will result in death or serious injury.
- ⚠ WARNING** indicates a potentially hazardous situation which, if not avoided, could result in death or serious injury.
- ⚠ CAUTION** indicates a potentially hazardous situation which, if not avoided, may result in minor or moderate injury
- CAUTION** used without the safety alert symbol indicates potentially hazardous situation which, if not avoided, may result in property damage.

IMPORTANT SAFETY INSTRUCTIONS

⚠ WARNING Improper operation or maintenance of this product could result in serious injury and property damage. **Read and understand all warnings and operating instructions before using.**

HAZARD	WHAT CAN HAPPEN	HOW TO PREVENT IT
<p>⚠ DANGER</p> <p>RISK OF EXPLOSION OR FIRE</p> <div style="display: flex; flex-direction: column; gap: 5px;">   </div>	<ul style="list-style-type: none"> Spilled gasoline and it's vapors can become ignited from cigarette sparks, electrical arcing, exhaust gases, and hot engine components such as the muffler. Heat will expand fuel in the tank which could result in spillage and possible fire explosion. Operating the pressure washer in an explosive environment could result in a fire. Materials placed against or near the pressure washer can interfere with its proper ventilation features causing overheating and possible ignition of the materials . Muffler exhaust heat can damage painted surfaces, melt any material sensitive to heat (such as siding, plastic, rubber, or vinyl), and damage live plants. Improperly stored fuel could lead to accidental ignition. Fuel improperly secured could get into the hands of children or other un-qualified persons. Use of acids, toxic or corrosive chemicals, poisons, insecticides, or any kind of flammable solvent with this product could result in serious injury or death. 	<ul style="list-style-type: none"> Shut off engine and allow it to cool before adding fuel to the tank. Use care in filling tank to avoid spilling fuel. Move pressure washer away from fueling area before starting engine. Keep maximum fuel level 1/2" below top of tank to allow for expansion. Operate and fuel equipment in well ventilated areas free from obstructions. Equip areas with fire extinguisher suitable for gasoline fires. Never operate pressure washer in an area containing dry brush or weeds. Always keep pressure washer a minimum of four feet away from surfaces (such as houses, automobiles, or live plants) that could be damaged from muffler exhaust heat Store fuel in an OSHA approved container, in a secure location away from work area. Do not spray flammable liquids.

HAZARD	WHAT CAN HAPPEN	HOW TO PREVENT IT
<p>▲ DANGER RISK TO BREATHING</p> 	<ul style="list-style-type: none"> Breathing exhaust fumes will cause serious injury or death! Some cleaning fluids contain substances which could cause injury to skin, eyes, or lungs. 	<ul style="list-style-type: none"> Operate pressure washer in a well ventilated area. Avoid enclosed areas such as garages, basements, etc. Never operate unit in a location occupied by humans or animals. Use only cleaning fluids specifically recommended for high pressure washers. Follow manufacturers recommendations. Do not use chlorine bleach or any other corrosive compound.
<p>▲ DANGER RISK OF INJURY OR PROPERTY DAMAGE WHEN TRANSPORTING OR STORING</p> 	<ul style="list-style-type: none"> Fuel or oil can leak or spill and could result in fire or breathing hazard, serious injury or death can result. Fuel or oil leaks will damage carpet, paint or other surfaces in vehicles or trailers. 	<ul style="list-style-type: none"> If pressure washer is equipped with a fuel shut-off valve, turn the valve to the off position before transporting to avoid fuel leaks. If pressure washer is not equipped with a fuel shut-off valve, drain the fuel from tank before transporting. Only transport fuel in an OSHA approved container. Always place pressure washer on a protective mat when transporting to protect against damage to vehicle from leaks. Remove pressure washer from vehicle immediately upon arrival at your destination.
<p>▲ WARNING RISK TO FLUID INJECTION</p> 	<ul style="list-style-type: none"> Your washer operates at fluid pressures and velocities high enough to penetrate human and animal flesh, which could result in amputation or other serious injury. Leaks caused by loose fittings or worn or damaged hoses can result in injection injuries. DO NOT TREAT FLUID INJECTION AS A SIMPLE CUT! See a physician immediately! Injuries can result if system pressure is not reduced before attempting maintenance or disassembly. 	<ul style="list-style-type: none"> Never place hands in front of nozzle. Direct spray away from self and others. Make sure hose and fittings are tightened and in good condition. Never hold onto the hose or fittings during operation. Do not allow hose to contact muffler. Never attach or remove wand or hose fittings while system is pressurized. To relieve system pressure, shut off engine, turn off water supply, and pull gun trigger until water stops flowing. Use only hose and high pressure accessories rated for pressure higher than your pressure washer's p.s.i.
<p>▲ WARNING RISK OF CHEMICAL BURN</p> 	<ul style="list-style-type: none"> Use of acids, toxic or corrosive chemicals, poisons, insecticides, or any kind of flammable solvent with this product could result in serious injury or death. 	<ul style="list-style-type: none"> Do not use acids, gasoline, kerosene, or any other flammable materials in this product. Use only household detergents, cleaners and degreasers recommended for use in pressure washers. Wear protective clothing to protect eyes and skin from contact with sprayed materials.

HAZARD	WHAT CAN HAPPEN	HOW TO PREVENT IT
<p>⚠ WARNING RISK OF UNSAFE OPERATION</p> 	<ul style="list-style-type: none"> • Unsafe operation of your pressure washer could lead to serious injury or death to you or others. • If proper starting procedure is not followed, engine can kickback causing serious hand and arm injury. • The spray gun/wand is a powerful cleaning tool that could look like a toy to a child. • Reactive force of spray will cause gun/wand to move, and could cause the operator to slip or fall, or misdirect the spray. Improper control of gun/wand can result in injuries to self and others. 	<ul style="list-style-type: none"> • Do not use chlorine bleach or any other corrosive compound. • Become familiar with the operation and controls of the pressure washer. • Keep operating area clear of all persons, pets, and obstacles. • Do not operate the product when fatigued or under the influence of alcohol or drugs. Stay alert at all times. • Never defeat the safety features of this product. • Do not operate machine with missing, broken, or unauthorized parts. • Never leave wand unattended while unit is running. • If engine does not start after two pulls, squeeze trigger of gun to relieve pump pressure. Pull starter cord slowly until resistance is felt. Then pull cord rapidly to avoid kickback and prevent hand or arm injury. • Keep children away from the pressure washer at all times. • Do not overreach or stand on an unstable support. Grip gun/wand firmly with both hands. Expect the gun to kick when triggered.
<p>⚠ WARNING RISK OF ELECTRICAL SHOCK</p> 	<ul style="list-style-type: none"> • Spray directed at electrical outlets or switches, or objects connected to an electrical circuit, could result in a fatal electrical shock. 	<ul style="list-style-type: none"> • Unplug any electrically operated product before attempting to clean it. Direct spray away from electric outlets and switches.
<p>⚠ WARNING RISK OF HOT SURFACES</p> 	<ul style="list-style-type: none"> • Contact with hot surfaces, such as engines exhaust components, could result in serious burn. 	<ul style="list-style-type: none"> • During operation, touch only the control surfaces of the pressure washer. Keep children away from the pressure washer at all times. They may not be able to recognize the hazards of this product.
<p>⚠ WARNING RISK OF INJURY FROM SPRAY</p> 	<ul style="list-style-type: none"> • High velocity fluid spray can cause objects to break, propelling particles at high speed. • Light or unsecured objects can become hazardous projectiles. 	<ul style="list-style-type: none"> • Always wear ANSI approved Z87 safety glasses. Wear protective clothing to protect against accidental spraying. • Never point wand at, or spray people or animals. • Always secure trigger lock when wand is not in service to prevent accidental operation. • Never permanently secure trigger in pull back (open) position.

CAUTION

The powerful spray from your pressure washer is capable of causing damage to surfaces such as wood, glass, automobile paint, auto stripping and trim, and delicate objects such as flowers and shrubs. Before spraying, check the item to be cleaned to assure yourself that it is strong enough to resist damage from the force of the spray. Avoid the use of the concentrated spray stream except for very strong surfaces like concrete and steel.

Operating without flow of water will result in equipment damage. Operating the pressure washer with water supply shutoff will void your warranty. You should never run this pressure washer for more than 2 minutes without pulling the trigger to allow cool water to enter the pump and the heated (recirculated) water to exit.

BOX CONTENTS

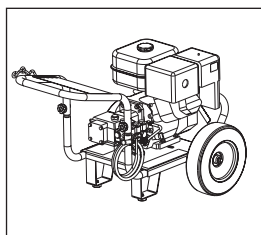

**Engine Frame and
Wheel Assembly**

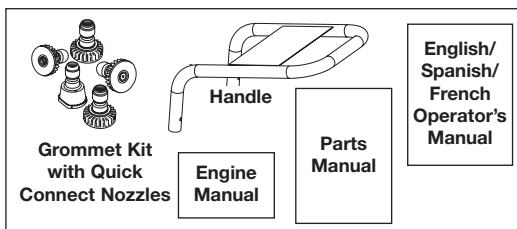

Bagged Handle



Engine Oil

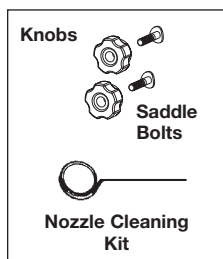

Bagged Parts



**High
Pressure
Hose**



**Chemical
Hose**

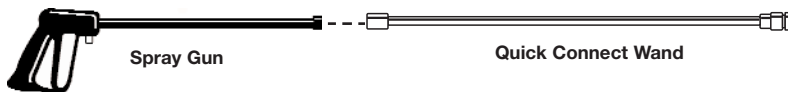

Spray Gun

Quick Connect Wand



**Hose Reel with parts bag and
instruction manual**

ASSEMBLY

1. Connect handle (a) and tube bracket (b) to frame using the hardware (c) supplied.
2. Assemble hose reel (d) as described in the hose reel instruction manual.

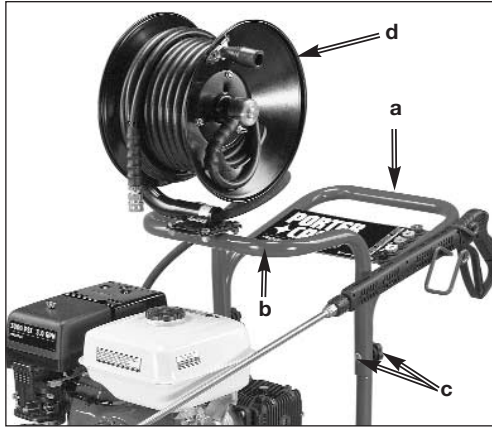

3. Connect wand to gun. Tighten securely.



4. Attach high pressure hose to gun. Tighten securely.



5. Assemble grommet kit and quick-connect nozzles as described in instructions supplied.
6. Add engine oil (supplied) to engine. Refer to engine manual supplied by engine manufacturer for correct procedure.

NOTE: There will be a slight amount of oil in the engine from factory testing.

NOTE: The high pressure pump was filled with oil at the factory. There is no need to add oil at this time, see the Maintenance section of this manual for maintenance information.

OPERATION

Know Your Pressure Washer

READ THIS OWNER'S MANUAL AND SAFETY RULES BEFORE OPERATING YOUR UNIT. Compare the illustrations with your unit to familiarize yourself with the location of various controls and adjustments. Save this manual for future reference.

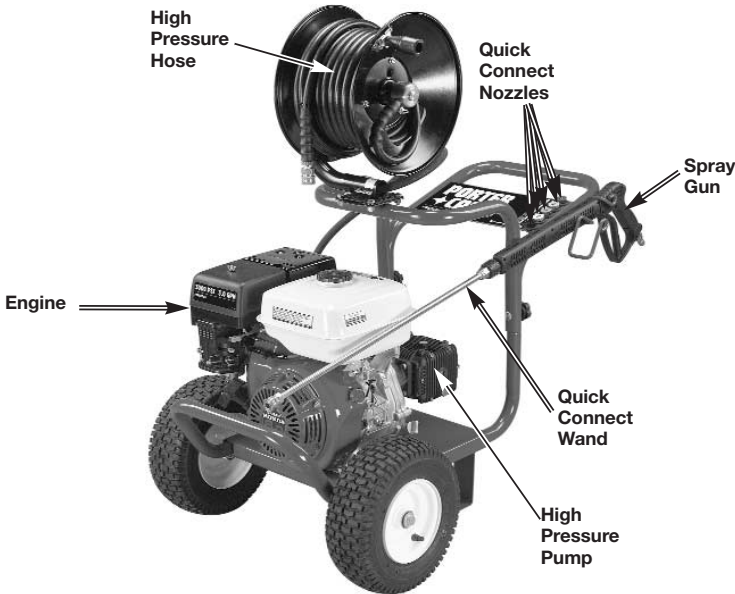

PRESSURE WASHER

High Pressure Pump: Increases the pressure of the water supply.

Engine: Drives the high pressure pump.

High Pressure Hose: Carries the pressurized water from the pump to the gun and wand.

Spray Gun: Connects with wand to control water flow rate, direction, and pressure.

Quick Connect Wand: Wand is equipped with a female quick connect coupler on the end. This allows the user to quickly change out high-pressure nozzles for different spray patterns and change to the soap nozzle for low pressure and chemical/soap applications. See Operation section.

Chemical Hose: Allows cleaners or cleaning solvents to be mixed with the pressurized water stream. See How To Siphon Chemicals/Cleaning Solvents in Operation section of this manual.

BASIC ELEMENTS OF ENGINE

Refer to the engine manual for location and operation of engine controls.

Choke Control: Opens and closes carburetor choke valve

Throttle Control Lever: Controls engine speed.

Starter Grip: Pulling starter grip operates recoil starter to crank engine.

Fuel Valve Lever: Opens / closes connection between fuel tank and carburetor.
Engine Switch: Enables and disables ignition system pressure washer operating features

PRESSURE WASHER TERMINOLOGY

NOTE: Become familiar with this terminology before operating.

PSI: Pounds per Square Inch. The unit of measure for water pressure. Also used for air pressure, hydraulic pressure, etc.

GPM: Gallons Per Minute. The unit of measure for the flow rate of water through the pressure washer.

CU: Cleaning Units. GPM multiplied by PSI.

Bypass Mode: In Bypass Mode, the pump is recirculating water because the trigger of the spray gun is not pulled. If unit is left in bypass mode for more than two (2) minutes, the water temperature can rise to a dangerous level and may damage internal components of the pump. Any damage to pump due to these causes will not be covered under warranty.

CAUTION

DO NOT allow your unit to operate in bypass mode for more than two minutes at any time. Overheating of pump can

cause damage to pump.

Thermal Relief Valve: In an effort to prevent damage, pumps are equipped with a thermal relief valve. This valve will open when the temperature inside the pump rises too high. This valve will then release a gush of water in an effort to lower the temperature inside the pump. Immediately after this occurs, the valve will close.

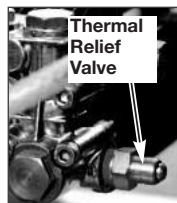

Chemical Injection: Feeds cleaning agents into the pump to mix with the pressurized water and help in cleaning.

Water Supply: All pressure washers must have a source of water. The minimum requirements for a water supply are 20 PSI and 5 gallons per minute.

HOW TO USE

IMPORTANT: Read and understand how to use the pressure washer before operating.

TO ADJUST PRESSURE

The pressure setting is preset at the factory to achieve optimum pressure and cleaning. If you need to lower the pressure, it can be accomplished by these methods.

1. **Back away from the surface to be cleaned.** The further away you are, the less the pressure will be on the surface to be cleaned.

CAUTION **DO NOT try to turn pressure regulator knob past the built-in stop or damage to pump will result.**

2. **Change to a wider spray pattern nozzle.** See How to Use Wand paragraph in this section.
3. **Adjust the pressure regulator on the pump.** Turn the pressure regulator knob counterclockwise to lower pressure. Refer to the illustrations to identify your pressure regulator.

Once you have finished using your pressure washer, return the pressure regulator to its original position by turning it clockwise.

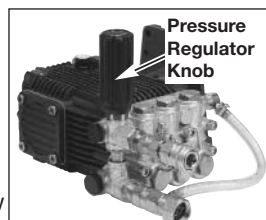

TO USE WAND

Your pressure washer is equipped with five spray nozzles. Each nozzle is color coded and delivers a specific spray pattern for a particular cleaning purpose. The size of the nozzle determines the size of the fan spray and the pressure out of the nozzle. The 0°, 15°, 25°, and 40° nozzles are high pressure nozzles. The chemical nozzle is a low pressure nozzle.

The nozzles are housed in receptacles on the panel of the pressure washer handle. Colors on the panel identify nozzle location and spray pattern.

⚠ WARNING Risk of injection or injury to person. Do not direct discharge stream toward persons, unprotected skin, eyes, or any pets or animals. Serious injury can occur.

Changing Nozzles

⚠ CAUTION DO NOT attempt to change nozzles while pressure washer is running.

Turn engine off before changing nozzles.

1. Pull quick connect coupler back and insert nozzle.
2. Release quick connect coupler and twist nozzle to make sure it is secure in coupler.

⚠ WARNING Risk Of Injury. Ensure nozzle is completely inserted in QC socket, and QC snap ring is fully engaged (forward) before squeezing gun trigger.



0° nozzle - Red. This nozzle delivers a pinpoint stream and is extremely powerful. It covers a very small area of cleaning. This nozzle should only be used on surfaces that can withstand this high pressure such as metal or concrete. Do not use on wood.



15° nozzle - Yellow. This nozzle delivers a powerful 15 degree spray pattern for intense cleaning of small areas. This nozzle should only be used on areas that can withstand the high pressure from this nozzle.



25° nozzle - Green. This nozzle delivers a 25 degree spray pattern for intense cleaning of larger areas. This nozzle should only be used on areas that can withstand the pressure from this nozzle.



40° nozzle - White. This nozzle delivers a 40 degree spray pattern and a less powerful stream of water. It covers a wide area of cleaning. This nozzle should be used for most general cleaning jobs.

Chemical nozzle - Black. This nozzle is used to apply chemicals or cleaning solutions. It has the least powerful stream.

TO SIPHON CHEMICALS/CLEANING SOLVENTS

Siphoning chemicals or cleaning solvents is a low pressure operation.

NOTE: Use only soaps and chemicals designed for pressure washer use. Do not use bleach.

1. **Press chemical hose onto barbed fitting** located near high pressure hose connection of pump as shown.
2. **Place other end of chemical hose with filter on it into container** holding chemical/cleaning solution.
3. **Install low pressure (black) nozzle** into quick connect fitting of wand, see **How To Use Wand** paragraph in this section.
4. **After use of chemical**, siphon clean water through chemical hose to rinse it and pump clean. Chemicals which remain in pump can damage it. Damage to pump due to chemicals will not be covered under warranty.

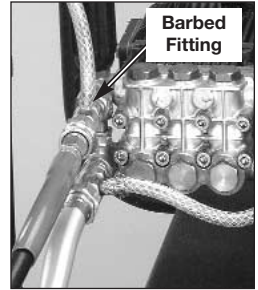

NOTE: Chemicals and soap will not siphon when wand is in the high pressure setting.

READ AND UNDERSTAND ALL WARNINGS BEFORE STARTING UNIT

⚠ DANGER **When using the high pressure setting, DO NOT** allow the high pressure spray to come in contact with unprotected skin, eyes, or with any pets or animals. Serious injury can occur.

Your washer operates at fluid pressures and velocities high enough to penetrate human and animal flesh, which could result in amputation or other serious injury. Leaks caused by loose fittings or worn or damaged hoses can result in injection injuries. **DO NOT TREAT FLUID INJECTION AS A SIMPLE CUT! See a physician immediately!**

⚠ WARNING **Never** fill fuel tank when engine is running or hot. Do not smoke when filling fuel tank.

Never fill fuel tank completely. Fill tank to 1/2" below bottom of filler neck to provide space for fuel expansion. Wipe any fuel spillage from engine and equipment before starting engine.

Never run engine indoors or in enclosed, poorly ventilated areas. Engine exhaust contains carbon monoxide, an odorless and deadly gas.

DO NOT let hoses come in contact with very hot engine muffler during or immediately after use of your pressure washer. Damage to hoses from contact with hot engine surfaces will NOT be covered by warranty.

⚠ CAUTION **Never** pull water supply hose to move pressure washer. This could damage hose and/or pump inlet.

DO NOT use hot water, use cold water only.

Never turn water supply off while pressure washer engine is running or damage to pump will result.

DO NOT stop spraying water for more than two minutes at a time. Pump operates in bypass mode when spray gun trigger is not pressed. If pump is left in bypass mode for more than two minutes internal components of the pump can be damaged.

If you do not understand these precautions please call 1-888-559-8550 to speak to a service representative for further instructions.

TO SHUT DOWN

IMPORTANT: Read and understand how to shut down the pressure washer before operating.

1. If you have siphoned chemicals, siphon a bucket of clean water through the chemical hose. **NOTE:** Failure to do so will cause damage to the pump.
2. Refer to engine manual for correct engine shut down procedure.

NOTE: NEVER turn the water off with the engine running.

3. Turn water source off.
4. Pull trigger on spray gun to relieve any water pressure in hose or spray gun.
5. See Storage section in this manual for proper storage procedures.

STARTING

Prior to starting, refer to your engine manual for proper starting procedures for your engine type.

1. **In a well ventilated outdoor area** Add fresh high quality unleaded gasoline with a pump octane rating of 86 or higher. Do not overfill. Wipe up spilled fuel before starting the engine. Refer to engine manual for correct procedure.
2. **Check engine oil level.** See Engine Operators Manual for correct procedure.

NOTE: There will be a slight amount of oil in the engine from factory testing.

3. **Verify the filter screen** is in water inlet of pump. **NOTE:** Cone side faces out.

4. **Connect** water source to pump inlet.

NOTE: Water source must provide a minimum of 5 gallons per minute at 20 p.s.i.

5. **Connect** high pressure hose to pump outlet.

6. **If applying a chemical or cleaning solution,** see How To Siphon Chemicals/Cleaning Solvents in Operation section of this manual.

7. **Turn water source on.** **NOTE:** Make sure water supply is turned on.

8. **Start engine.** See Engine operators Manual for correct procedure. **NOTE:** If the engine does not start after two pulls, pull the trigger to relieve the pressure.

9. **Depress trigger on gun to start water flow.** **NOTE:** Stand on a stable surface and grip gun/wand firmly with both hands. Expect the gun to kick when triggered.

10. **Release trigger to stop water flow.**

11. **Adjust nozzle spray for the task** being performed or change quick connect tip. See **How To Use Wand** instructions in this section.

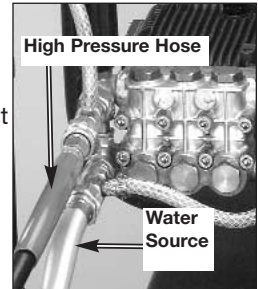
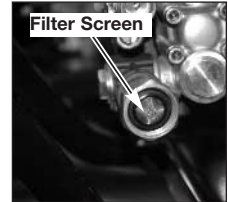

MAINTENANCE

⚠ DANGER WHEN PERFORMING MAINTENANCE, YOU MAY BE EXPOSED TO HOT SURFACES, WATER PRESSURE, MOVING PARTS, OR FIRE RESULTING IN DEATH. BEFORE PERFORMING ANY MAINTENANCE OR REPAIR, DISCONNECT SPARK PLUG WIRE, LET ENGINE COOL AND RELEASE ALL WATER PRESSURE. THE ENGINE CONTAINS FLAMMABLE FUEL. DO NOT SMOKE OR WORK NEAR OPEN FLAMES WHILE PERFORMING MAINTENANCE.

To ensure efficient operation and longer life of your pressure washer, a routine maintenance schedule should be prepared and followed. If the pressure washer is used in unusual conditions, such as high-temperatures or dusty conditions, more frequent maintenance checks will be required.

ENGINE

Refer to engine manual for the manufacturer's recommendations for any and all maintenance.

PUMP

NOTE: The pump was filled with oil at the factory.

1. Change pump oil after the first ten (10) hours of operation and every fifty (50) hours thereafter.

How To Change Pump Oil

1. Loosen oil fill cap.
2. Place a container under the oil drain plug.
3. Remove oil drain plug.
4. After oil is drained replace oil drain plug. Tighten securely.
5. Remove oil fill cap and fill with recommended oil. See the Pump Oil Chart for the correct amount and type of oil.
6. Replace oil fill cap and tighten securely.

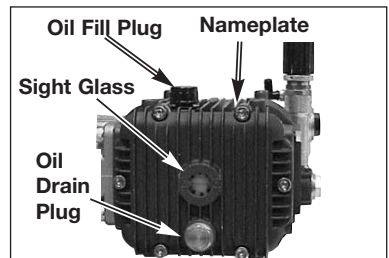

PUMP OIL CHART

PUMP TYPE	OIL TYPE	OIL CAPACITY
Annovi Reverberi (XMV)	30 W non detergent	13.5 oz.

WAND

If the nozzle becomes clogged with foreign materials, such as dirt, excessive pressure may develop. If the nozzle becomes partially clogged or restricted, the pump pressure will pulsate. Clean the nozzle immediately using the nozzle kit supplied and the following instructions:

1. Shut off the pressure washer and turn off the water supply.
2. Disconnect spark plug wire.
3. Pull trigger on gun handle to relieve any water pressure.
4. Disconnect the wand from the gun.
5. Remove the high-pressure nozzle from the wand. Remove any obstructions with the nozzle cleaning tool provided and backflush with clean water.

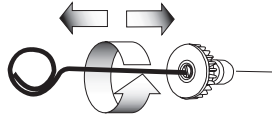

6. Direct water supply into nozzle end to backflush loosened particles for 30 seconds.

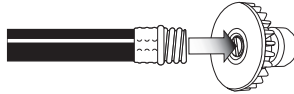

7. Reassemble the nozzle to the wand.
8. Reconnect wand to gun and turn on water supply.
9. Start pressure washer and place wand into high pressure setting to test.

HOW TO CLEAN THE WATER INLET FILTER

This screen filter should be checked periodically and cleaned if necessary.

1. **Remove filter** by grasping end and removing it from water inlet of pump as shown.
2. **Clean filter** by flushing it with water on both sides.
3. **Re-insert filter** into water inlet of pump. **NOTE:** Cone side faces out.

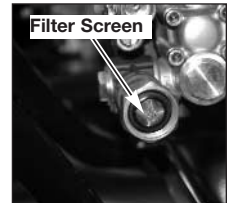

STORAGE

ENGINE

Consult the Engine Owners Manual for the manufacturer's recommendations for storage.

PUMP

It is recommended that you follow these steps to protect the internal seals of the pressure washer when **STORING THE UNIT FOR AN EXTENDED PERIOD and/or WHEN FREEZING TEMPERATURES ARE EXPECTED.**

NOTE: If storing the unit for more than 30 days ***RV antifreeze** needs to be run through the pump. This helps prevent damage within the pump head. ***RV antifreeze** is not only added for winterizing, but for proper lubrication regardless of temperature or environment.

***Windshield washer fluid may also be used.**

1. **Obtain a funnel**, six ounces of ***RV antifreeze**, and approximately 12 inches of garden hose with a male hose connector attached to one end.

⚠ CAUTION

Use only *RV antifreeze. Any other antifreeze is corrosive and can damage pump.

2. **Disconnect spark plug wire.**
3. **Disconnect high pressure hose** from pump and from spray gun.
4. **Connect 12 inch length of hose** to water inlet of pump.
5. **Add *RV antifreeze** to hose as shown.
6. **Pull engine starter rope slowly several times** until antifreeze comes out of high pressure hose connection of pump.
7. **Remove short hose** from water inlet of pump.
8. **Reconnect spark plug wire.**
9. **Drain all water from high pressure hose**, coil it, and store it in cradle of the pressure washer handle.
10. **Drain all water from spray gun** and wand by holding spray gun in a vertical position with nozzle end pointing down and squeezing trigger. Store in gun/hose holder.
11. **Store chemical hose**, high pressure hose, spray gun, and wand so they are protected from damage, such as being run over.



TROUBLE SHOOTING GUIDE

PROBLEM	CAUSE	CORRECTION
Engine will not start (see Engine Manual for further engine troubleshooting)	No fuel.	Add Fuel.
	Low oil (if equipped with low oil shutdown).	Add required amount of oil.
	Pressure builds up after two pulls on the recoil starter or after initial use.	Squeeze gun trigger to relieve pressure.
	Not primed or choked.	Push primer bulb 3 times or choke engine.
	Spark plug wire not attached.	Attach spark plug wire.
	Engine ON/OFF switch in OFF position (If applicable.)	Place engine ON/OFF switch in on position.
	Choke lever in the "Choke" position on a "hot" engine or an engine that has been exposed to thermal heat for a long period of time.	Move choke to the "No Choke" position.
Fuel valve closed (if equipped)	Move the fuel valve lever to the "Open" position.	
No or low pressure (initial use)	Wand not in high pressure.	See How to Use Wand paragraph in the Operation Section.
	Low water supply.	Water supply must be at least 5 GPM @ 20 PSI.
	Leak at high pressure hose.	Repair leak. Apply sealant tape if necessary.
	Nozzle obstructed.	Clean nozzle with paper clip or nozzle cleaning tool, pour water into nozzle end to flush out obstruction.
	Water filter screen clogged.	Remove and clean filter.
	Defective E-Z start valve.	Check with Authorized Warranty Service Center (AWSC.)
	Air in hose.	Turn off the engine, then the water source. Disconnect the water source from the pump inlet and turn the water source on to remove all air from the hose. When there is a steady stream of water present, turn water source off. Reconnect water source to pump inlet and turn on water source. Squeeze trigger to remove remaining air
	Choke lever in the "Choke" position.	Move choke to the "No Choke" position.
	Throttle control lever is not in the "Fast" position. (if equipped)	Move throttle control lever to the "Fast" position.
High pressure hose is too long.	Use high pressure hose under 100 feet.	

PROBLEM	CAUSE	CORRECTION
Will not draw chemicals	Wand not in low pressure.	See How to Use Wand paragraph in the Operation Section.
	Chemical filter clogged.	Clean filter.
	Chemical screen not in chemical	Insure end of chemical hose is fully submerged into chemical.
	Chemical too thick.	Dilute chemical. Chemical should be the same consistency as water.
	Pressure hose is too long	Lengthen water supply hose instead of pressure hose.
	Chemical build up in chemical injector.	Have parts cleaned or replaced by AWSC.
No or low pressure (after period of normal use)	Worn seal or packing	Have replaced by AWSC.
	Worn or obstructed valves.	Have replaced by AWSC.
	Worn unloader piston.	Have replaced by AWSC.
	Worn E-Z start valve.	Have replaced by AWSC.
Water leaking at gun/wand connection	Worn or broken o-ring.	Tighten.
	Loose hose connection.	Check and replace.
Water leaking at pump	Loose connections.	Tighten.
	Piston packings worn.	Have replaced by AWSC.
	Worn or broken o-rings.	Have replaced by AWSC.
	Pump head or tubes damaged from freezing.	Have replaced by AWSC.
Oil leaking at pump	Oil seals worn.	Have replaced by AWSC
	Loose drain plug.	Tighten.
	Worn drain plug, o-ring	Check and replace.
	Worn fill plug o-ring.	Check and replace.
	Pump overfilled.	Check for correct amount.
	Incorrect oil used.	Drain and fill with correct amount and type of oil.
	Vent plug is clogged.	Clean vent plug; blow air through it to remove any blockage. If problem persists, replace plug.

LIMITED WARRANTY

PORTER-CABLE CORPORATION warrants to the original purchaser that all products covered under this warranty are free from defects in material and workmanship. Products covered under this warranty include air compressors, air tools, service parts, pressure washers, and generators, which have the following warranty periods:

3 YEARS - Limited warranty on 2-stage oil-free air compressor pumps that operate at 1725 RPM.

2 YEARS - Limited warranty on oil-lubricated air compressor pumps.

1 YEAR - Limited warranty on all other air compressor components.

2 YEARS - Limited warranty on electric generator alternators.

1 YEAR - Limited warranty on other generator components.

2 YEARS - Limited warranty on pneumatic air tools as described in Porter-Cable general catalog.

1 YEAR - Limited warranty on pressure washers used in consumer applications (i.e. personal residential household usage only).

90 DAY - Pressure washers used for commercial applications (income producing) and service parts.

1 YEAR - Limited warranty on all accessories.

Porter-Cable will repair or replace, at **Porter-Cable's** option, products or components which have failed within the warranty period. Service will be scheduled according to the normal work flow and business hours at the service center location, and the availability of replacement parts. All decisions of **Porter-Cable** Corporation with regard to this limited warranty shall be final.

This warranty gives you specific legal rights, and you may also have other rights which vary from state to state.

RESPONSIBILITY OF ORIGINAL PURCHASER (initial User):

- To process a warranty claim on this product, DO NOT return it to the retailer. The product must be evaluated by an **Porter-Cable** Authorized Warranty Service Center. For the location of the nearest **Porter-Cable** Authorized Warranty Service Center call 1-888-559-8550, 24 hours a day, 7 days a week.
- Retain original cash register sales receipt as proof of purchase for warranty work.
- Use reasonable care in the operation and maintenance of the product as described in the Owners Manual(s).
- Deliver or ship the product to the nearest **Porter-Cable** Authorized Warranty Service Center. Freight costs, if any, must be paid by the purchaser.
- Air compressors with 60 and 80 gallon tanks will be inspected at the site of installation. Contact the nearest **Porter-Cable** Authorized Warranty Service Center that provides on-site service calls, for service call arrangements.
- If the purchaser does not receive satisfactory results from the **Porter-Cable** Authorized Warranty Service Center, the purchaser should contact Porter-Cable.

THIS WARRANTY DOES NOT COVER:

- Merchandise sold as reconditioned, used as rental equipment, and floor or display models.
- Merchandise that has become damaged or inoperative because of ordinary wear, misuse*, cold, heat, rain, excessive humidity, freeze damage, use of improper chemicals, negligence, accident, failure to operate the product in accordance with the instructions provided in the Owners Manual(s) supplied with the product, improper maintenance, the use of accessories or attachments not recommended by **Porter-Cable**, or unauthorized repair or alterations.
- * An air compressor that pumps air more than 50% during a one hour period is considered misuse because the air compressor is undersized for the required air demand.
- Repair and transportation costs of merchandise determined not to be defective.
- Costs associated with assembly, required oil, adjustments or other installation and start-up costs.
- Expendable parts or accessories supplied with the product which are expected to become inoperative or unuseable after a reasonable period of use, including but not limited to sanding disks or pads, saw and shear blades, grinding stones, springs, chisels, nozzles, o-rings, air jets, washers and similar accessories.
- Merchandise sold by **Porter-Cable** which has been manufactured by and identified as the product of another company, such as gasoline engines. The product manufacturer's warranty, if any, will apply.
- **ANY INCIDENTAL, INDIRECT OR CONSEQUENTIAL LOSS, DAMAGE, OR EXPENSE THAT MAY RESULT FROM ANY DEFECT, FAILURE OR MALFUNCTION OF THE PRODUCT IS NOT COVERED BY THIS WARRANTY.** Some states do not allow the exclusion or limitation of incidental or consequential damages, so the above limitation or exclusion may not apply to you.
- **IMPLIED WARRANTIES, INCLUDING THOSE OF MERCHANTABILITY OR FITNESS FOR A PARTICULAR PURPOSE, ARE LIMITED TO ONE YEAR FROM THE DATE OF ORIGINAL PURCHASE.** Some states do not allow limitations on how long an implied warranty lasts, so the above limitations may not apply to you.

PORTER-CABLE

Porter-Cable Corporation
Jackson, TN USA
1-888-559-8550

NOTES

QUICK FACTS

CALL 1-888-559-8550

TO FIND A LOCAL AUTHORIZED SERVICE CENTER NEAR YOU FOR REPAIRS AND SERVICE PART PURCHASES.

GAS	Use fresh high quality gas. Add stabilizer to fuel tank and run engine for 5 minutes before storage.
OIL	Pump oil: Refer to owners manual supplied with this unit. Engine oil: Refer to engine manual supplied with this unit. Some units are equipped with a low oil sensor and adequate oil must be added or the unit will not start.
WATER	Use only cold water. Don't operate unit with clogged or missing water filter/screen. Don't operate unit without adequate water supply to pump. Adequate water supply is a minimum of 20 psi and 5 gpm.
PRESSURE ADJUSTMENT	The pressure setting is preset at the factory to achieve optimum cleaning. If you need to lower the pressure setting, refer to the owners manual for proper procedure.
PUMP	Pull gun trigger every 2 minutes while engine is running. Don't allow water to freeze in pump. Siphon RV antifreeze into pump for cold weather storage or long term storage.
BY-PASS MODE	Never leave unit running for more than 2 minutes without pulling gun trigger; doing so may damage pump and void warranty.
THERMAL RELIEF VALVE	Pump is equipped with a thermal relief valve. If the water overheats, this valve will open and allow a gush of water to escape. Once the water is released, the valve closes allowing the pump to operate normally.
HOSE	Don't allow hoses to contact the HOT engine muffler during or after use. Never pull the hose to move the unit.
ENGINE	Do not adjust or attempt maintenance without consulting engine manual or an authorized engine service center. Add stabilizer to fuel tank and run engine for 5 minutes before storage. Always turn on the water before starting the engine.
SOAP/CHEMICALS	Use only soaps and chemicals designed for pressure washer use.
NOZZLE	Keep nozzle unclogged. Refer to manual for cleaning procedures. Chemical/soap cannot be siphoned in high pressure setting. Only in low setting.
MAINTENANCE SCHEDULE	Follow recommended maintenance schedule for engine & pump. Refer to manuals.
STORAGE OR WINTERIZING	Draw clean water through chemical inlet. Add stabilizer to fuel tank and run engine for 5 minutes before storage. Don't allow water to freeze in pump, gun, wand or hoses. Siphon RV antifreeze into pump for cold weather storage or long term storage.

ALWAYS REFER TO THE MANUALS SUPPLIED WITH THIS UNIT

Free Manuals Download Website

<http://myh66.com>

<http://usermanuals.us>

<http://www.somanuals.com>

<http://www.4manuals.cc>

<http://www.manual-lib.com>

<http://www.404manual.com>

<http://www.luxmanual.com>

<http://aubethermostatmanual.com>

Golf course search by state

<http://golfingnear.com>

Email search by domain

<http://emailbydomain.com>

Auto manuals search

<http://auto.somanuals.com>

TV manuals search

<http://tv.somanuals.com>