

MODEL 5043

PORTER-CABLE MAGIC GUIDE

IMPORTANT

Please make certain that the person who is to use this equipment carefully reads and understands these instructions before starting operations.

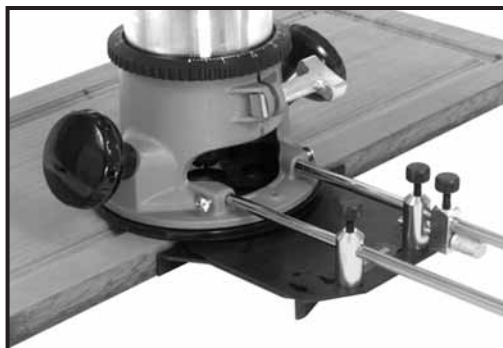

INTRODUCTION

In the following pages are outlined the basic applications for the Magic Guide. Study them carefully before using your Magic Guide. We suggest that you practice making the basic cuts on scrap material to thoroughly acquaint yourself with the manipulation of the router when used with the Magic Guide.

IMPORTANT SAFETY INSTRUCTIONS

⚠ WARNING When using electric tools, basic safety precautions should always be followed to reduce the risk of fire, electric shock and personal injury, including the rules on Page 2 and 3.

**READ AND FOLLOW ALL INSTRUCTIONS IN THIS MANUAL
AND THE MANUAL FOR YOUR ROUTER.**

There are certain applications for which this tool was designed. Porter-Cable strongly recommends that this tool NOT be modified and/or used for any application other than for which it was designed. If you have any questions relative to its application DO NOT use the tool until you have written Porter-Cable and we have advised you.

Technical Service Manager
Porter-Cable Corporation
4825 Highway 45 North
P. O. Box 2468
Jackson, TN 38302-2468

- 1. KEEP WORK AREA CLEAN.** Cluttered areas and benches invite injuries.
- 2. AVOID DANGEROUS ENVIRONMENT.** Don't expose power tools to rain. Don't use power tools in damp or wet locations. Keep area well lit. Avoid chemical or corrosive environment. Do not use tool in presence of flammable liquids or gases.
- 3. GUARD AGAINST ELECTRIC SHOCK.** Prevent body contact with grounded surfaces. For example: pipes, radiators, ranges, refrigerator enclosures.
- 4. KEEP CHILDREN AWAY.** Do not let visitors contact tool or extension cord. All visitors should be kept away from work area.
- 5. STORE IDLE TOOLS.** When not in use, tools should be stored in dry, and high or locked-up place – out of the reach of children.
- 6. DON'T FORCE TOOL.** It will do the job better and safer at the rate for which it was intended.
- 7. USE RIGHT TOOL.** Don't force small tool or attachment to do the job of a heavy duty tool. Don't use tool for purpose not intended – for example – do not use a circular saw for cutting tree limbs or logs.
- 8. DRESS PROPERLY.** Do not wear loose clothing or jewelry. Loose clothing, draw strings and jewelry can be caught in moving parts. Rubber gloves and non-skid footwear are recommended when working outdoors. Wear protective hair covering to contain long hair.
- 9. USE SAFETY GLASSES.** Wear safety glasses or goggles while operating power tools. Also face or dust mask if operation creates dust. All persons in the area where power tools are being operated should also wear safety glasses and face or dust mask.
- 10. DON'T ABUSE CORD.** Never carry tool by cord or yank it to disconnect from receptacle. Keep cord from heat, oil, and sharp edges. Have damaged or worn power cord and strain reliever replaced immediately.
- 11. SECURE WORK.** Use clamps or a vise to hold work. It's safer than using your hand and it frees both hands to operate tool.
- 12. DON'T OVERREACH.** Keep proper footing and balance at all times.
- 13. MAINTAIN TOOLS WITH CARE.** Keep tool cords periodically and if damaged, have repaired by authorized service facility. Inspect extension cords periodically and replace if damaged. Have all worn, broken or lost parts replaced immediately. Keep handles dry, clean and free from oil and grease.
- 14. DISCONNECT TOOLS** when not in use, before servicing, and when changing accessories such as blades, bits, cutters, etc.
- 15. REMOVE ADJUSTING KEYS AND WRENCHES.** Form habit of checking to see that keys and adjusting wrenches are removed from the tool before turning it on.
- 16. AVOID UNINTENTIONAL STARTING.** Do not carry a plugged-in tool with finger on switch. Be sure switch is off when plugging in. Keep hands, body and clothing clear of blades, bits, cutters, etc. when plugging in the tool.
- 17. OUTDOOR USE EXTENSION CORDS.** When tool is used outdoors, use only extension cords marked "Suitable for use with outdoor appliances – store indoors when not in use."
- 18. STAY ALERT.** Watch what you are doing. Use common sense. Do not operate tool when you are tired or while under the influence of medication, alcohol or drugs.

19. CHECK DAMAGED PARTS. Before further use of the tool, a guard or other part that is damaged should be carefully checked to determine that it will operate properly and perform its intended function. Check for alignment of moving parts, binding of moving parts, breakage of parts, mounting, and any other conditions that may affect its operation. A guard or other part that is damaged should be properly repaired or replaced by an authorized seNice center unless otherwise indicated elsewhere in this instruction manual. Have defective switches replaced by authorized service center. Do not use tool if switch does not turn it on and off.

20. WEAR EAR PROTECTION to safeguard against possible hearing loss.

21. NEVER ADJUST DEPTH OF CUT WHILE MOTOR IS RUNNING. A slip at this time may cause personal injury, or damage to cutter or workpiece.

22. BE SURE CORD SET IS FREE and will not “hang up” during routing operations.

23. KEEP HANDS CLEAR OF CUTTER when motor is running to prevent personal injury.

24. MAINTAIN FIRM GRIP on router when starting motor to resist starting torque.

25. STAY ALERT and keep cutter clear of all foreign objects while motor is running.

26. BE SURE MOTOR HAS COMPLETELY STOPPED before setting machine down between operations.

27. SOME WOOD CONTAINS PRESERVATIVES WHICH CAN BE TOXIC. Take extra care to prevent inhalation and skin contact when working with these materials. Request, and follow, any safety information available from your material supplier.

CARTON CONTENTS

* Porter-Cable Magic Guide

* Groove guide bar

* Other hardware

* Fulcrum pin

* Micrometer adjusting blocks and guide rod posts

OPERATION

Fig. 1 shows the posts, micrometer adjusting block and guide rods assembled to the top (flat) plate. At the left of Fig. 2, the flat head screws that secure the posts can be seen.

The micrometer adjusting block and guide rod posts are mounted on the top side (side on which A, B and C are stamped) of the top (flat) plate.

The posts are located in holes marked A, B, or C so that the guide rods line up with the mounting holes in the base of your Porter-Cable Router.

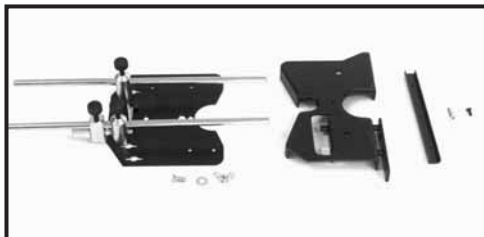

Fig. 1

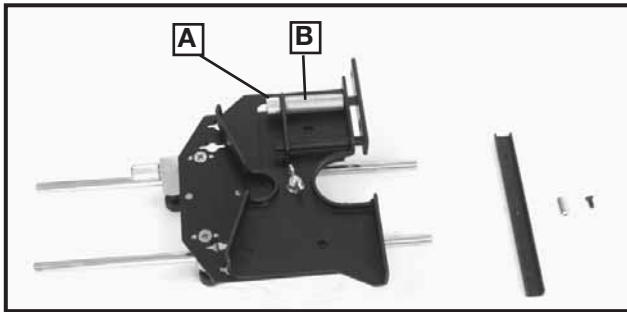

Fig. 2

Fig. 2 shows the Magic Guide from the underside with the base plate mounted in place and held with the screw, washer and wing nut shown at the bottom center of Fig. 1.

ATTACHING MAGIC GUIDE TO ROUTER

In all applications, the Magic Guide's guide rods are secured to the router in the holes provided in the router, as shown at (A) Fig. 5. Make sure you select the proper width so that the guide rods are straight. To secure the rods, use the two screws provided with the guide, one of which is shown at (B) Fig. 5.

APPLICATION: EDGE GUIDE

Fig. 3 shows the type of work done with the Magic Guide used as a simple Edge Guide.

▲ CAUTION Make sure router is disconnected from power supply while making adjustments and installing or removing bits and cutters.

Adjustments:

1. Loosen short, knurled lock nut (A) Fig. 2.
2. Adjust movable shoe plate, by turning long, knurled nut (B) Fig. 2 until it is in line with wall of the base plate.
3. Check alignment with a straight edge.
4. Tighten short, knurled nut (A) to lock shoe plate.
5. Select a bit that will make the desired width of cut and install it in your router.
6. Loosen all three knurled screws (C,D and E) Fig. 5, and adjust guide so router will make cut desired distance from edge of work.
7. Tighten knurled screw (E) only. A final, fine adjustment of the position of the router is now made with the micro-adjusting screw (F).
8. Tighten screws (C) and (D).
9. Adjust router bit for desired depth of cut.

Making the Cut: Move router from left to right, guiding it with the Edge Guide as shown in Fig. 5. Fig. 4 shows how the two flat surfaces of the Edge Guide move along on the edge of the work.

Limits: Using the Magic Guide as an Edge Guide, a cut can be made as far as about seven inches in from the edge.

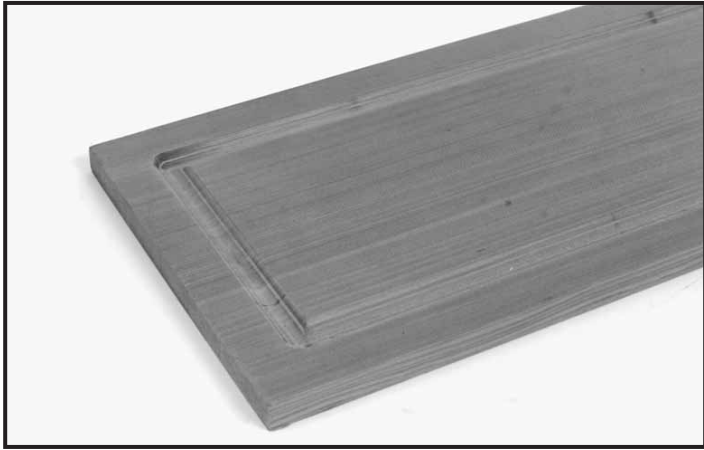

Fig. 3

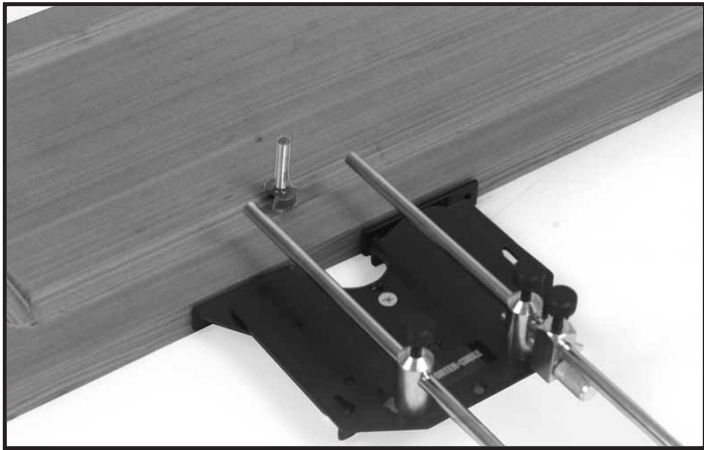

Fig. 4

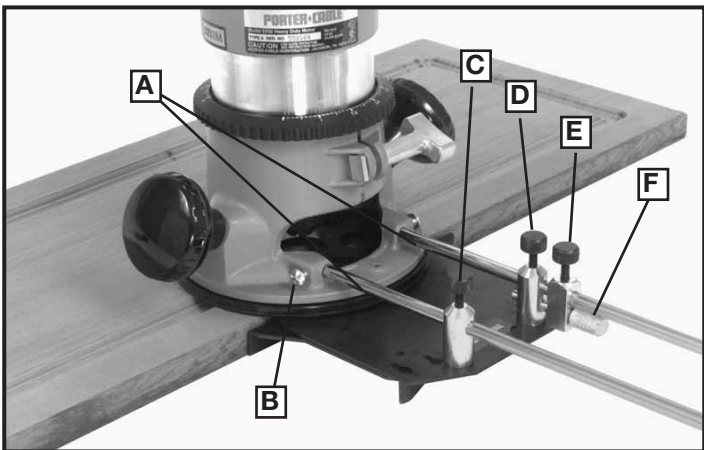

Fig. 5

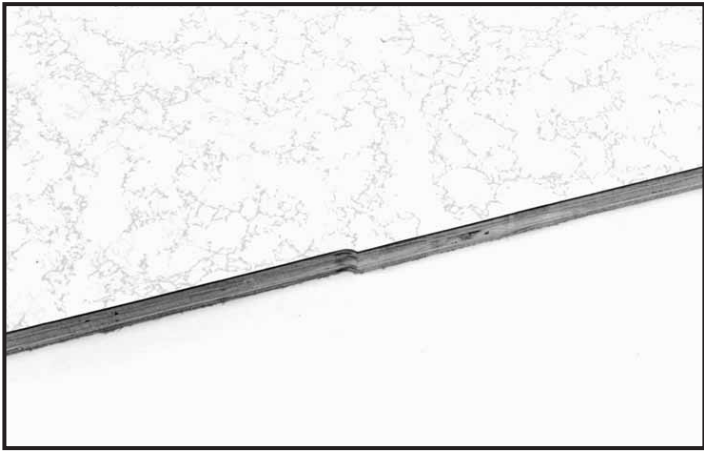

Fig. 6

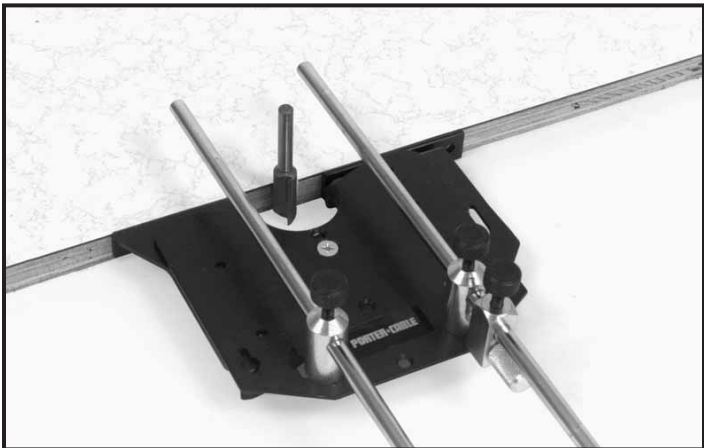

Fig. 7

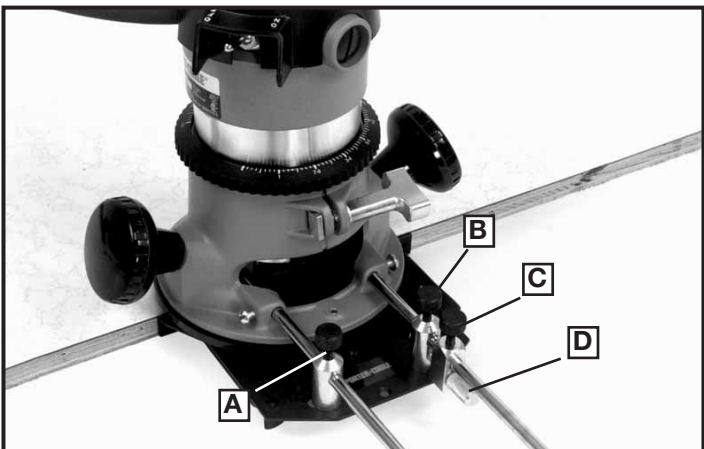

Fig. 8

APPLICATION: EDGE PLANE

The Magic Guide can be used as an Edge Plane to plane the edge of the work to a smooth finish (see left side of Fig. 6). Plane the rough and chipped finish of plywood and laminated plastic stock (see right side of Fig. 6) to form a straight edge before jointing or edge finishing.

▲CAUTION Make sure router is disconnected from power supply while making adjustments and installing or removing bits and cutters.

Adjustments:

1. Set leading or right (adjustable shoe plate) edge back from the trailing (left) edge a distance equal to the amount of stock you wish to remove. (See Fig. 7). It is recommended that when considerable stock is to be removed that several cuts be made instead of one.
2. Install bit in router and adjust for correct depth (thickness of work).
3. Loosen knurled screws (A,B and C) Fig. 8 and roughly adjust the guide so cutting edge of bit is in line with trailing edge of guide.
4. Tighten knurled screw (C). While holding a straight edge against the wall of the trailing edge, adjust position of guide, by turning micro-screw (D), until cutting edge of bit just touches straight edge. **NOTE: Turning router and guide assembly upside down might make step 4 easier.**
5. Tighten both screws (A and B). The relative position of bit to guide will then be similar to that shown in Fig. 7.

Making the Cut: Start the cut at the left end of the work with only the leading edge of the guide flat against the edge of the work. Move router from left to right. As the cut progresses, the trailing edge will also contact and ride along on the edge of the work (see Figs. 7 and 8).

Limits: The length of the cutting edge of the bit limits the thickness of stock to be planed.

Recommendations: We recommend carbide or carbide-tipped bits for cutting plywood and/or plastics because the resins used in their fabrication cause burn spots on regular high speed steel bits

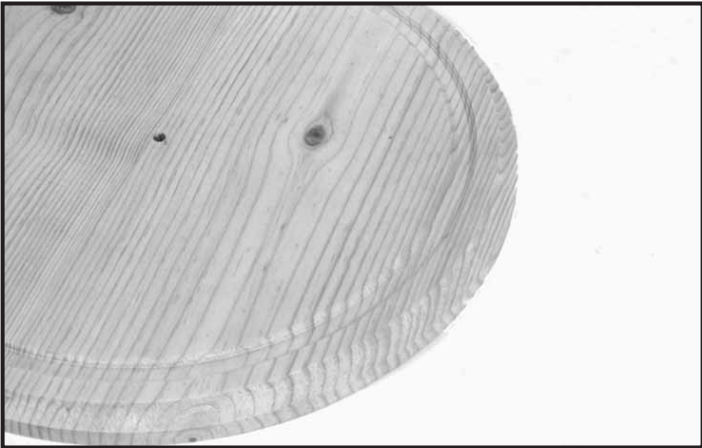

Fig. 9

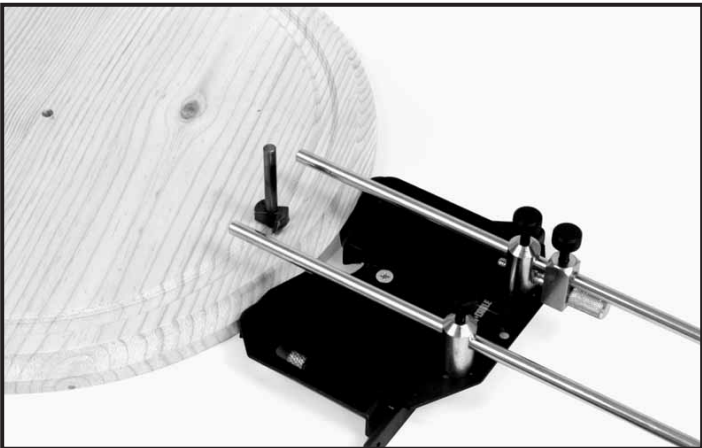

Fig. 10



Fig. 11

APPLICATION: RADIUS GUIDE

The Magic Guide, used as a Radius Guide, can guide the router along an arc or curved edge like a round table top. In the case shown in Fig. 9, the routed groove was filled with colored wood putty and then sanded to present a handsome appearance to the finished table top.

⚠ CAUTION Make sure router is disconnected from power supply while making adjustments and installing or removing bits and cutters.

Adjustments:

1. Assuming that you have just used your Magic Guide as an Edge Guide or Plane, loosen the wing nut on the bottom and rotate the base plate one-half turn (180°). Locating bosses on this plate will drop into positioning holes in the top plate when properly located (see Fig. 10). Tighten wing nut firmly.
2. Select and install bit or cutter in router.
3. Adjustments for distance from edge of work and depth of cut are made the same as outlined in steps 6 through 9 under ADJUSTMENTS FOR THE EDGE GUIDE (see page 4).

Making the Cut: Move the router from left to right, guiding it with the Radius Guide (see Fig. 11). Fig. 10 shows how the two surfaces of the Radius Guide ride along and on the curved work edge.

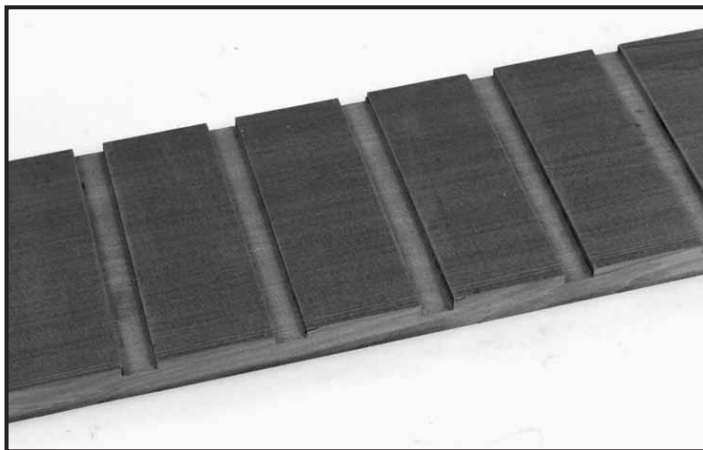

Fig. 12

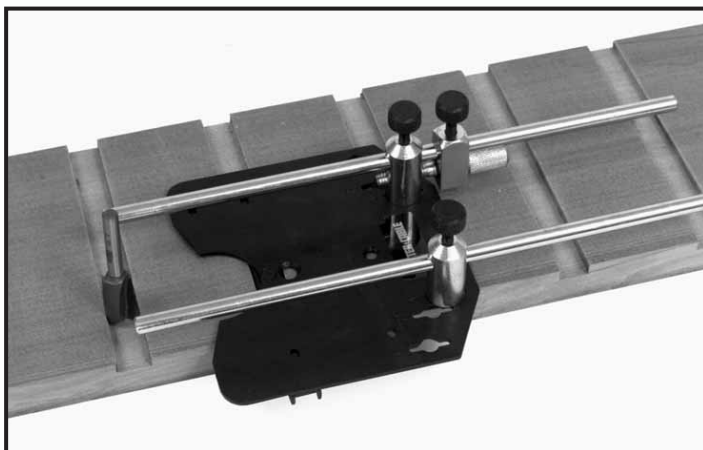

Fig. 13

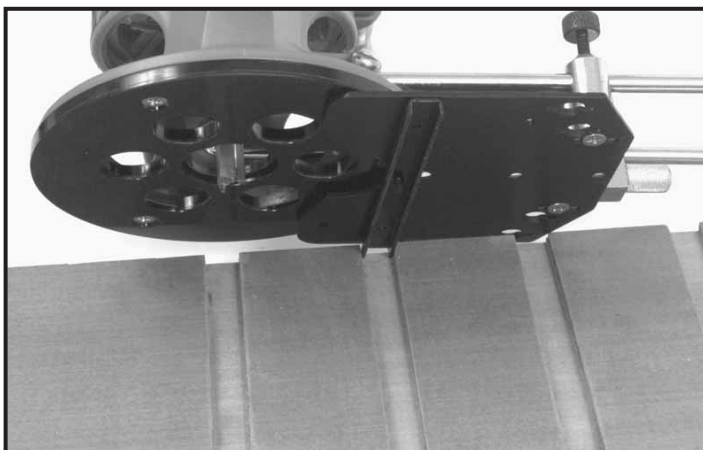

Fig. 14

APPLICATION: GROOVE GUIDE

The Magic Guide can be used as a Groove Guide to make grooves, slots, dados, ploughs, gains, etc. Grooves are evenly spaced (see Fig. 12). Practical applications might include grooves for shelving, slots for records, sliding doors, mirrors or windows.

▲ CAUTION Make sure router is disconnected from power supply while making adjustments and installing or removing bits and cutters.

Adjustments:

1. If you have been using the Magic Guide as an Edge Guide, Edge Plane or Radius Guide, remove the base plate (see plate at right of Fig. 1) by removing the wing nut, flat washer and screw that attach it to the top plate.
2. Attach groove guide bar (see bar at right of Fig. 1) to bottom front of top plate with small flat head screw. When the bar is properly positioned bosses on it will drop into locating holes in the plate (see Figs. 13 and 14). For wider spaced grooves, the bar may be attached to the other end of the plate (in last hole): in this position the locating bosses will rest against the angled rear edges of the base plate.
3. Select and install the bit or cutter in your router.
4. Adjustments for distance between grooves are made the same as outlined in steps 6 through 9 under ADJUSTMENTS FOR THE EDGE GUIDE (see page 4).

Making the Cut: The first groove is made with the Edge Guide or the Groove Bar used to locate the groove the desired distance from the edge of the work. If the first groove is too far from the edge to use either of the above, securely clamp a straight edge to the work and guide the router base along it.

Limits: Grooves $\frac{1}{2}$ " and wider can be made. Also, grooves a fraction of an inch apart and up to over 11 inches apart can be made absolutely parallel with ease.

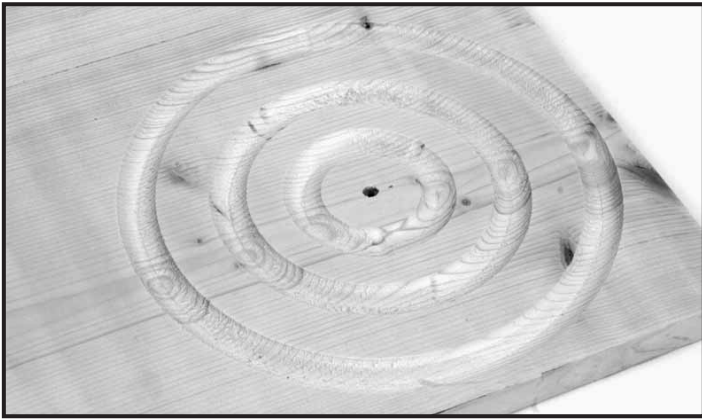

Fig. 15

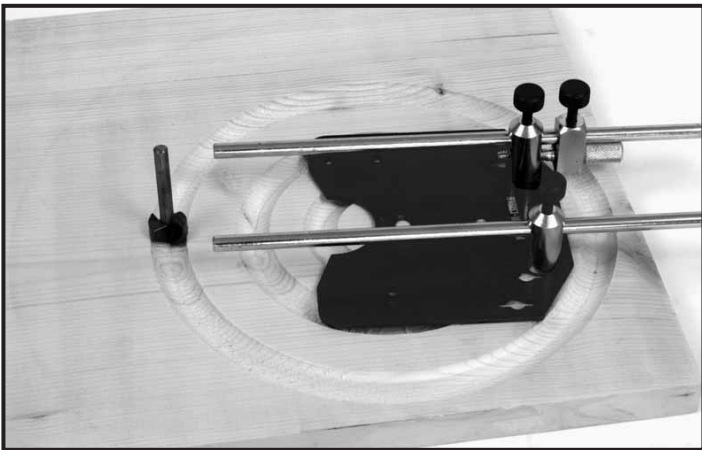

Fig. 16



Fig. 17

APPLICATION: CIRCLE GUIDE

The most intricate of circular-shaped (see Fig. 15) cuts can be made with the Magic Guide. Perhaps you have seen cuts like these on modern garage door panels or on inlaid coffee or card tables. You, too, can be an expert when you use the Magic Guide as a Circle Guide.

▲ CAUTION Make sure router is disconnected from power supply while making adjustments and installing or removing bits and cutters.

Adjustments:

1. If you have been using your Magic Guide as an Edge Guide, Edge Plane, or Radius Guide, remove the base plate (see plate at right of Fig. 1) by removing the wing nut, flat washer and screw that attach it to the top plate.
2. If you have been using your Magic Guide as a Groove Guide, remove the groove guide bar.
3. Attach the fulcrum pin (see extreme right of Fig. 1) to the bottom of the top plate with the small flat head screw – the same screw used to attach the groove guide bar. It may be attached at any one of the three holes that are countersunk to receive the small screw.
4. Select the bit or cutter to give the desired contour of cut and install it in your router. Adjust for depth of cut.
5. Adjustments for distance of cutter or bit from fulcrum pin are made the same as outlined in steps 6 through 9 under ADJUSTMENTS FOR THE EDGE GUIDE (see page 4).

Making the Cut: First select the location of the center of the circle. Then drill a ¼" hole at this point to receive the fulcrum pin. The hole should be deep enough (approx. 17/32") so the Top Plate will rest flat on the work. Insert the fulcrum pin in the hole and rout the circle in a clockwise direction (see Fig. 16). In the segmented design, you'll notice tiny nail holes just outside the large rim (see Fig. 17). These were located 90° apart and nails used in place of the fulcrum pin to pivot the router for the four arcs within the large circle.

TROUBLESHOOTING GUIDE

For assistance with your tool, visit our website at www.porter-cable.com for a list of service centers or call the Porter-Cable help line at 1-800-487-8665.

WARRANTY

PORTER-CABLE LIMITED ONE YEAR WARRANTY

Porter-Cable warrants its Professional Power Tools for a period of one year from the date of original purchase. We will repair or replace at our option, any part or parts of the product and accessories covered under this warranty which, after examination, proves to be defective in workmanship or material during the warranty period. For repair or replacement return the complete tool or accessory, transportation prepaid, to your nearest Porter-Cable Service Center or Authorized Service Station. Proof of purchase may be required. This warranty does not apply to repair or replacement required due to misuse, abuse, normal wear and tear or repairs attempted or made by other than our Service Centers or Authorized Service Stations.

ANY IMPLIED WARRANTY, INCLUDING THE IMPLIED WARRANTIES OF MERCHANTABILITY AND FITNESS FOR A PARTICULAR PURPOSE, WILL LAST ONLY FOR ONE (1) YEAR FROM THE DATE OF PURCHASE.

To obtain information on warranty performance please write to: PORTER-CABLE CORPORATION, 4825 Highway 45 North, Jackson, Tennessee 38305; Attention: Product Service. THE FOREGOING OBLIGATION IS PORTER-CABLE'S SOLE LIABILITY UNDER THIS OR ANY IMPLIED WARRANTY AND UNDER NO CIRCUMSTANCES SHALL PORTER-CABLE BE LIABLE FOR ANY INCIDENTAL OR CONSEQUENTIAL DAMAGES. Some states do not allow limitations on how long an implied warranty lasts or the exclusion or limitation of incidental or consequential damages, so the above limitation or exclusion may not apply to you.

This warranty gives you specific legal rights and you may also have other legal rights which vary from state to state.

PORTER-CABLE • DELTA SERVICE CENTERS (CENTROS DE SERVICIO DE PORTER-CABLE • DELTA) (CENTRE DE SERVICE PORTER-CABLE • DELTA)

Parts and Repair Service for Porter-Cable • Delta Power Tools are Available at These Locations
(Obtenga Refaccion de Partes o Servicio para su Herramienta en los Siguietes Centros de Porter-Cable • Delta)
(Locations où vous trouvez les pièces de rechange nécessaires ainsi qu'un service d'entretien)

ARIZONA

Tempe 85282 (Phoenix)
2400 West Southern Avenue
Suite 105
Phone: (602) 437-1200
Fax: (602) 437-2200

CALIFORNIA

Ontario 91761 (Los Angeles)
3949A East Guasti Road
Phone: (909) 390-5555
Fax: (909) 390-5554

San Diego 92111
7638 Clairemont Blvd.
Phone: (858) 277-9595
Fax: (858) 277-9696

San Leandro 94577 (Oakland)
3039 Teagarden Street
Phone: (510) 357-9762
Fax: (510) 357-7939

COLORADO

Arvada 80003 (Denver)
8175 Sheridan Blvd., Unit S
Phone: (303) 487-1809
Fax: (303) 487-1868

FLORIDA

Davie 33314 (Miami)
4343 South State Rd. 7 (441)
Unit #107
Phone: (954) 321-6635
Fax: (954) 321-6638

Tampa 33609
4538 W. Kennedy Boulevard
Phone: (813) 877-9585
Fax: (813) 289-7948

GEORGIA

Forest Park 30297 (Atlanta)
5442 Frontage Road,
Suite 112
Phone: (404) 608-0006
Fax: (404) 608-1123

ILLINOIS

Addison 60101 (Chicago)
400 South Rohling Rd.
Phone: (630) 424-8805
Fax: (630) 424-8895

Woodridge 60517 (Chicago)
2033 West 75th Street
Phone: (630) 910-9200
Fax: (630) 910-0360

MARYLAND

Elkridge 21075 (Baltimore)
7397-102 Washington Blvd.
Phone: (410) 799-9394
Fax: (410) 799-9398

MASSACHUSETTS

Franklin 02038 (Boston)
Franklin Industrial Park
101E Constitution Blvd.
Phone: (508) 520-8802
Fax: (508) 528-8089

MICHIGAN

Madison Heights 48071 (Detroit)
30475 Stephenson Highway
Phone: (248) 597-5000
Fax: (248) 597-5004

MINNESOTA

Minneapolis 55429
5522 Lakeland Avenue North
Phone: (763) 561-9080
Fax: (763) 561-0653

MISSOURI

North Kansas City 64116
1141 Swift Avenue
Phone: (816) 221-2070
Fax: (816) 221-2897

St. Louis 63119
7574 Watson Road
Phone: (314) 968-8950
Fax: (314) 968-2790

NEW YORK

Flushing 11365-1595 (N.Y.C.)
175-25 Horace Harding Expwy.
Phone: (718) 225-2040
Fax: (718) 423-9619

NORTH CAROLINA

Charlotte 28270
9129 Monroe Road, Suite 115
Phone: (704) 841-1176
Fax: (704) 708-4625

OHIO

Columbus 43214
4560 Indianapolis Avenue
Phone: (614) 263-0929
Fax: (614) 263-1238

Cleveland 44125
8001 Sweet Valley Drive
Unit #19
Phone: (216) 447-9030
Fax: (216) 447-3097

OREGON

Portland 97230
4916 NE 122 nd Ave.
Phone: (503) 252-0107
Fax: (503) 252-2123

PENNSYLVANIA

Willow Grove 19090 (Philadelphia)
520 North York Road
Phone: (215) 658-1430
Fax: (215) 658-1433

TEXAS

Carrollton 75006 (Dallas)
1300 Interstate 35 N, Suite 112
Phone: (972) 446-2996
Fax: (972) 446-8157

WASHINGTON

Houston 77043
4321 Sam Houston Parkway, West
Suite 180
Phone: (713) 983-9910
Fax: (713) 983-6645

WASHINGTON

Auburn 98001 (Seattle)
3320 West Valley HWY, North
Building D, Suite 111
Phone: (253) 333-8353
Fax: (253) 333-9613

Authorized Service Stations are located in many large cities. Telephone **800-487-8665** or **731-541-6042** for assistance locating one. Parts and accessories for Porter-Cable • Delta products should be obtained by contacting any Porter-Cable • Delta Distributor, Authorized Service Center, or Porter-Cable • Delta Factory Service Center. If you do not have access to any of these, call **888-848-5175** and you will be directed to the nearest Porter-Cable • Delta Factory Service Center. Las Estaciones de Servicio Autorizadas están ubicadas en muchas grandes ciudades. Llame al **800-487-8665** ó al **731-541-6042** para obtener asistencia a fin de localizar una. Las piezas y los accesorios para los productos Porter-Cable • Delta deben obtenerse poniéndose en contacto con cualquier distribuidor Porter-Cable • Delta, Centro de Servicio Autorizado o Centro de Servicio de Fábrica Porter-Cable • Delta. Si no tiene acceso a ninguna de estas opciones, llame al **888-848-5175** y le dirijirán al Centro de Servicio de Fábrica Porter-Cable • Delta más cercano. Des centres de service agréés sont situés dans beaucoup de grandes villes. Appelez au **800-487-8665** ou au **731-541-6042** pour obtenir de l'aide pour en repérer un. Pour obtenir des pièces et accessoires pour les produits Porter-Cable • Delta, s'adresser à tout distributeur Porter-Cable • Delta, centre de service agréé ou centre de service d'usine Porter-Cable • Delta. Si vous n'avez accès à aucun de ces centres, appeler le **888-848-5175** et on vous dirigera vers le centre de service d'usine Porter-Cable • Delta le plus proche.

CANADIAN PORTER-CABLE • DELTA SERVICE CENTERS

ALBERTA

Bay 6, 2520-23rd St. N.E.
Calgary, Alberta
T2E 8L2
Phone: (403) 735-6166
Fax: (403) 735-6144

BRITISH COLUMBIA

8520 Baxter Place
Burnaby, B.C.
V5A 4T8
Phone: (604) 420-0102
Fax: (604) 420-3522

MANITOBA

1699 Dublin Avenue
Winnipeg, Manitoba
R3H 0H2
Phone: (204) 633-9259
Fax: (204) 632-1976

ONTARIO

505 Southgate Drive
Guelph, Ontario
N1H 6M7
Phone: (519) 767-4132
Fax: (519) 767-4131

QUÉBEC

1515 Ave.
St-Jean Baptiste, Suite 160
Québec, P.Q.
G2E 5E2
Phone: (418) 877-7112
Fax: (418) 877-7123

1447, Begin
St-Laurent, (Mtl), P.Q.
H4R 1V8
Phone: (514) 336-8772
Fax: (514) 336-3505

The following are trademarks of PORTER-CABLE • DELTA (Las siguientes son marcas registradas de PORTER-CABLE • DELTA S.A.) (Les marques suivantes sont des marques de fabricant de la PORTER-CABLE • DELTA): Auto-Set[®], BAMMER[®], B.O.S.S.[®], Builder's Saw[®], Contractor's Saw[®], Contractor's Saw II[™], Delta[™], DELTACRAFT[™], DELTAGRAM[™], Delta Series 2000[™], DURATRONIC[™], Emc^{2™}, FLEX[™], Flying Chips[™], FRAME SAW[®], Grip Vac[™], Homcraft[™], INNOVATION THAT WORKS[™], Jet-Lock[™], JETSTREAM[™], 'kickstand', LASERLOC[™], MICRO-SET[™], Micro-Set[®], MIDI LATHE[™], MORTEN[™], NETWORK[™], OMNIJIG[™], POCKET CUTTER[™], PORTA-BAND[™], PORTA-PLANE[™], PORTER-CABLE[®] & (design), PORTER-CABLE[®] PROFESSIONAL POWER TOOLS, PORTER-CABLE REDEFINING PERFORMANCE[™], Posi-Matic[™], Q-3[®] & (design), QUICKSAND[®] & (design), QUICKSET[™], QUICKSET II[™], QUICKSET PLUS[™], RIPTIDE[™] & (design), SAFE GUARD II[™], SAFE-LOC[™], Sanding Center[™], SANDTRAP[®] & (design), SAW BOSS[™], Sawbuck[™], Sidekick[™], SPEED-BLOC[™], SPEEDMATIC[™], SPEEDTRONIC[™], STAIR EASE[™], The American Woodshop[®] & (design), The Lumber Company[®] & (design), THE PROFESSIONAL EDGE[™], THE PROFESSIONAL SELECT[™], THIN-LINE[™], TIGER[®], TIGER CUB[®], TIGER SAW[®], TORQBUSTER[®], TORQ-BUSTER[®], TRU-MATCH[™], TWIN-LITE[™], UNIGUARD[™], Unifence[®], UNIFEDDER[™], Unihed[™], Uniplane[™], Unirip[™], Unisaw[™], Univise[™], Versa-Feeder[™], VERSA-PLANE[™], WHISPER SERIES[™], WOODWORKER'S CHOICE[™].

Trademarks noted with [™] and ® are registered in the United States Patent and Trademark Office and may also be registered in other countries. Las Marcas Registradas con el signo de [™] y ® son registradas por la Oficina de Registros y Patentes de los Estados Unidos y también pueden estar registradas en otros países. Marques déposées, indiquées par la lettre [™] et ®, sont déposées au Bureau des brevets d'invention et marques déposées. Downloaded from www.seamans.com All Manuals Search And Download. 7.2-PTG-F-1

Free Manuals Download Website

<http://myh66.com>

<http://usermanuals.us>

<http://www.somanuals.com>

<http://www.4manuals.cc>

<http://www.manual-lib.com>

<http://www.404manual.com>

<http://www.luxmanual.com>

<http://aubethermostatmanual.com>

Golf course search by state

<http://golfingnear.com>

Email search by domain

<http://emailbydomain.com>

Auto manuals search

<http://auto.somanuals.com>

TV manuals search

<http://tv.somanuals.com>