

# Instruction manual

## Double Insulated Random Orbit 5" Sander/6" Polisher

MODELS  
7335  
7336  
7336SP  
7355  
7366  
7424



### IMPORTANT

Please make certain that the person who is to use this equipment carefully reads and understands these instructions before starting operations.

The Model and Serial No. plate is located on the main housing of the tool. Record these numbers in the spaces below and retain for future reference.

Model No. \_\_\_\_\_

Type \_\_\_\_\_

Serial No. \_\_\_\_\_

To learn more about Porter-Cable  
visit our website at:

<http://www.porter-cable.com>

**PORTER-CABLE**  
PROFESSIONAL POWER TOOLS

## SAFETY GUIDELINES - DEFINITIONS

This manual contains information that is important for you to know and understand. This information relates to protecting YOUR SAFETY and PREVENTING EQUIPMENT PROBLEMS. To help you recognize this information, we use the symbols below. Please read the manual and pay attention to these sections.

### **⚠ DANGER**

indicates an imminently hazardous situation which, if not avoided, will result in death or serious injury.

### **⚠ WARNING**

indicates a potentially hazardous situation which, if not avoided, could result in death or serious injury.

### **⚠ CAUTION**

indicates a potentially hazardous situation which, if not avoided, may result in minor or moderate injury.

### **CAUTION**

used without the safety alert symbol indicates potentially hazardous situation which, if not avoided, may result in property damage.

### **⚠ WARNING**

**Some dust created by power sanding, sawing, grinding, drilling, and other construction activities contains chemicals known (to the State of California) to cause cancer, birth defects or other reproductive harm. Some example of these chemicals are:**

- lead from lead-based paints
- crystalline silica from bricks and cement and other masonry products
- arsenic and chromium from chemically-treated lumber

Your risk from these exposures varies, depending on how often you do this type of work. To reduce your exposure to these chemicals: work in a well ventilated area, and work with approved safety equipment, always wear MSHA/NIOSH approved, properly fitting face mask or respirator when using such tools.

## GENERAL SAFETY RULES



### **⚠ WARNING**

**Read and understand all instructions.** Failure to follow all instructions listed below, may result in electric shock, fire and/or serious personal injury.

**SAVE THESE INSTRUCTIONS.**

## WORK AREA

1. **Keep your work area clean and well lit.** Cluttered benches and dark areas invite accidents.
2. **Do not operate power tools in explosive atmospheres, such as in the presence of flammable liquids, gases, or dust.** Power tools create sparks which may ignite the dust or fumes.
3. **Keep bystanders, children, and visitors away while operating a power tool.** Distractions can cause you to lose control.

## ELECTRICAL SAFETY

1. **Double insulated tools are equipped with a polarized plug (one blade is wider than the other). This plug will fit in a polarized outlet only one way. If the plug does not fit fully in the outlet, reverse the plug. If it still does not fit, contact a qualified electrician to install a polarized outlet. Do not change the plug in any way.** Double Insulation  eliminates the need for the three wire grounded power cord and grounded power supply system.
2. **Avoid body contact with grounded surfaces such as pipes, radiators, ranges and refrigerators.** There is an increased risk of electric shock if your body is grounded.
3. **Do not expose power tools to rain or wet conditions.** Water entering a power tool will increase the risk of electric shock.
4. **Do not abuse the cord. Never use the cord to carry the tools or pull the plug from an outlet. Keep cord away from heat, oil, sharp edges or moving parts. Replace damaged cords immediately.** Damaged cords increase the risk of electric shock.

**5. When operating a power tool outside, use an outdoor extension cord marked “W-A” or “W”.** These cords are rated for outdoor use and reduce the risk of electric shock.

## **PERSONAL SAFETY**

**1. Stay alert, watch what you are doing, and use common sense when operating a power tool. Do not use tool while tired or under the influence of drugs, alcohol, or medication.** A moment of inattention while operating power tools may result in serious personal injury.

**2. Dress properly. Do not wear loose clothing or jewelry. Contain long hair. Keep your hair, clothing, and gloves away from moving parts.** Loose clothes, jewelry, or long hair can be caught in moving parts.

**3. Avoid accidental starting. Be sure switch is OFF before plugging in.** Carrying tools with your finger on the switch or plugging in tools that have the switch ON invites accidents.

**4. Remove adjusting keys or wrenches before turning the tool ON.** A wrench or a key that is left attached to a rotating part of the tool may result in personal injury.

**5. Do not overreach. Keep proper footing and balance at all times.** Proper footing and balance enables better control of the tool in unexpected situations.

**6. Use safety equipment. Always wear eye protection.** Dust mask, non-skid safety shoes, hard hat, or hearing protection must be used for appropriate conditions.

**7. Use certified safety equipment.** Eye protection equipment should comply with ANSI Z87.1 standards, hearing equipment should comply with ANSI S3.19 standards, and dust mask protection should comply with MSHA/NIOSH certified respirator standards.

**8. Never touch wheel immediately after use.** It may be extremely hot.

## **TOOLS USE AND CARE**

**1. Use clamps or other practical way to secure and support the workpiece to a stable platform.** Holding the work by hand or against your body is unstable and may lead to loss of control.

**2. Do not force tool. Use the correct tool for your application.** The correct tool will do the job better and safer at the rate for which it is designed.

**3. Do not use tool if switch does not turn it ON or OFF.** Any tool that cannot be controlled with the switch is dangerous and must be repaired.

**4. Disconnect the plug from the power source before making any adjustments, changing accessories, or storing the tool.** Such preventive safety measures reduce the risk of starting the tool accidentally.

**5. Store idle tools out of reach of children and other untrained persons.** Tools are dangerous in the hands of untrained users.

**6. Maintain tools with care. Keep cutting tools sharp and clean.** Properly maintained tools, with sharp cutting edges are less likely to bind and are easier to control.

**7. Check for misalignment or binding of moving parts, breakage of parts, and any other condition that may affect the tool's operation. If damaged, have the tool serviced before using.** Many accidents are caused by poorly maintained tools.

**8. Use only accessories that are recommended by the manufacturer for your model.** Accessories that may be suitable for one tool may become hazardous when used on another tool.

## **SERVICE**

**1. Tool service must be performed only by qualified repair personnel.** Service or maintenance performed by unqualified personnel could result in a risk of injury.

**2. When servicing a tool, use only identical replacement parts. Follow instructions in the Maintenance Section of this manual.** Use of unauthorized parts or failure to follow Maintenance Instructions may create a risk of electric shock or injury.

## SPECIFIC RULES AND SYMBOLS

- 1. Always use proper guard with grinding wheel.** A guard protects operator from broken wheel fragments.
- 2. Accessories must be rated for at least the speed recommended on the tool warning label.** Wheels and other accessories running over rated speed can fly apart and cause injury.
- 3. Hold tool by insulated gripping surfaces when performing an operation where the cutting tool may contact hidden wiring or its own cord.** Contact with a “live” wire will make exposed metal parts of the tool “live” and shock the operator.
- 4. Always disconnect the sander cord plug from the power circuit before changing abrasive sheets.**
- 5. Do not run tool with back-up pad removed.** Resulting vibration could cause loss of control.
- 6. Use proper safety equipment.** Wear safety goggles to protect your eyes and wear a protective mask to minimize breathing in the fine dust created while sanding.
- 7. Sanding of lead-based paint is not recommended.** Lead-based paint should only be removed by a professional.
- 8. Some wood contains preservatives which can be toxic.** Take extra care to prevent inhalation and skin contact when working with these materials. Request, and follow, any safety information available from your material supplier.

**⚠ WARNING** There are certain applications for which this tool was designed. Porter-Cable strongly recommends that this tool NOT be modified and/or used for any application other than for which it was designed. If you have any questions relative to its application DO NOT use the tool until you have written Porter-Cable and we have advised you.

Technical Service Manager  
Porter-Cable Corporation  
4825 Highway 45 North  
Jackson, TN 38305

## ADDITIONAL SAFETY RULES FOR PAINT REMOVAL









**⚠ WARNING** Extreme care should be taken when removing paint. The peelings, residue, and vapors of paint may contain lead, which is poisonous. Exposure to even low levels of lead can cause irreversible brain and nervous system damage; young and unborn children are particularly vulnerable.

Before beginning any paint removal process you should determine whether the paint you are removing contains lead. This can be done by your local health department or by a professional who uses a paint analyzer to check for lead.

### LEAD-BASED PAINT SHOULD ONLY BE REMOVED BY A PROFESSIONAL.

Persons removing paint should follow these guidelines:

- 1. KEEP THE WORK AREA WELL VENTILATED.** Open the windows and put an exhaust fan in one of them. Be sure the fan is moving air from inside to outside.
- 2. REMOVE OR COVER** any carpets, rugs, furniture, clothing, cooking utensils and air ducts.
- 3. PLACE DROP CLOTHS** in the work area to catch any paint chips or peelings. Wear protective clothing such as extra work shirts, overalls and hats.
- 4. WORK IN ONE ROOM AT A TIME.** Furnishings should be removed or placed in the center of the room and covered. Work areas should be sealed off from the rest of the dwelling by sealing doorways with drop cloths.
- 5. CHILDREN, PREGNANT OR POTENTIALLY PREGNANT** women and nursing mothers should not be present in the work area until the work is done and all cleanup is complete.
- 6. WEAR A DUST RESPIRATOR** or a dual filter (dust and fume) respirator mask which has been approved by the Occupational Safety and Health Administration (OSHA), the National Institute of Safety and Health (NIOSH), or the United States Bureau of Mines. These masks and replaceable filters are readily available at major hardware stores. Be sure the mask fits. Beards and facial hair may keep the masks from sealing properly. Change filters often. **DISPOSABLE PAPER MASKS ARE NOT ADEQUATE.**
- 7. KEEP FOOD AND DRINK** out of the work area. Wash hands, arms, and face and rinse mouth before eating or drinking. Do not smoke or chew gum or tobacco in the work area.
- 8. CLEAN UP ALL REMOVED PAINT** and dust by wet mopping the floors. Use a wet cloth to clean all walls, sills and any other surfaces where paint or dust is clinging. **DO NOT SWEEP, DRY DUST OR VACUUM.** Use a high phosphate detergent or trisodium (TSP) to wash and mop areas.
- 9. AT THE END OF EACH WORK SESSION** put the paint chips and debris in a double plastic bag, close it with tape or twist ties and dispose of properly.
- 10. REMOVE PROTECTIVE CLOTHING** and work shoes in the work area to avoid carrying dust into the rest of the dwelling. Wash work clothes separately. Wipe shoes off with a wet rag that is then washed with the work clothes. Wash hair and body thoroughly with soap and water.

<b>SYMBOL</b>	<b>DEFINITION</b>
V	volts
A	amperes
Hz	hertz
W	watts
kW	kilowatts
$\mu$ F	microfarads
l	liters
kg	kilograms
N/cm <sup>2</sup>	newtons per square centimeter
Pa	pascals
h	hours
min	minutes
s	seconds
	alternating current
3 	three-phase alternating current
3 <sub>N</sub> 	three-phase alternating current with neutral
	direct current
$n_0$	no load speed
	alternating or direct current
	Class II Construction
	splash-proof construction
	watertight construction
.../min	revolutions or reciprocation per minute

## REPLACEMENT PARTS

When servicing use only identical replacement parts. For a service parts list or to learn more about Porter-Cable visit our website at: <http://www.porter-cable.com>

## MOTOR

Many Porter-Cable tools will operate on either D.C., or single phase 25 to 60 cycle A.C. current and voltage within plus or minus 5 percent of that shown on the specification plate on the tool. Several models, however, are designed for A.C. current only. Refer to the specification plate on your tool for proper voltage and current rating.

**CAUTION** Do not operate your tool on a current on which the voltage is not within correct limits. Do not operate tools rated A.C. only on D.C. current. To do so may seriously damage the tool.

## EXTENSION CORD SELECTION

If an extension cord is used, make sure the conductor size is large enough to prevent excessive voltage drop which will cause loss of power and possible motor damage. A table of recommended extension cord sizes will be found in this section. This table is based on limiting line voltage drop to 5 volts (10 volts for 230 volts) at 150% of rated amperes.

If an extension cord is to be used outdoors it must be marked with the suffix W-A or W following the cord type designation. For example – SJTW-A to indicate it is acceptable for outdoor use.

### RECOMMENDED EXTENSION CORD SIZES FOR USE WITH PORTABLE ELECTRIC TOOLS

		Length of Cord in Feet									
		115V	25 Ft.	50 Ft.	100 Ft.	150 Ft.	200 Ft.	250 Ft.	300 Ft.	400 Ft.	500 Ft.
		230V	50 Ft.	100 Ft.	200 Ft.	300 Ft.	400 Ft.	500 Ft.	600 Ft.	800 Ft.	1000 Ft.
Nameplate Ampere Rating	0-2	18	18	18	16	16	14	14	12	12	
	2-3	18	18	16	14	14	12	12	10	10	
	3-4	18	18	16	14	12	12	10	10	8	
	4-5	18	18	14	12	12	10	10	8	8	
	5-6	18	16	14	12	10	10	8	8	6	
	6-8	18	16	12	10	10	8	6	6	6	
	8-10	18	14	12	10	8	8	6	6	4	
	10-12	16	14	10	8	8	6	6	4	4	
	12-14	16	12	10	8	6	6	6	4	2	
	14-16	16	12	10	8	6	6	4	4	2	
16-18	14	12	8	8	6	4	4	2	2		
18-20	14	12	8	6	6	4	4	2	2		

## FUNCTIONAL DESCRIPTION

### FOREWORD

The Porter-Cable Random Orbit Polisher performs various tasks including polishing, rubbing, and general cleaning jobs. Used as a Random Orbit Sander the tool provides rapid stock removal with 80 to 100 grit paper and swirl-free finishing with 120 to 150 grit paper.

## ASSEMBLY

### AUXILIARY HANDLE

An auxiliary handle (A), Fig. 1, is furnished with the tool. The auxiliary handle may be installed on either side of the front housing to facilitate either right-handed or left-handed operation.

**⚠ WARNING THIS HANDLE SHOULD BE USED AT ALL TIMES TO MAINTAIN COMPLETE CONTROL OF THE TOOL.**



Fig. 1

## TO START AND STOP TOOL

1. Make certain the switch is in the “OFF” position, and the power source is the same as that specified on the tool’s nameplate.
2. Connect the tool to the power source.
3. Slide the switch button (A), Fig. 2, forward to start motor. Slide switch button to the rear to stop motor.

## VARIABLE SPEED MODELS

Speed is adjusted by turning thumbwheel (A), Fig. 2A. Thumbwheel position #1 provides the slowest operating speed (2500 OPM) and position #6 the fastest (6000 OPM). Speed may be changed while motor is running or while it is stopped.

## USING THE POLISHER

**WARNING** If the item to be polished is light enough to be moved by the rotating pad, it should be securely anchored to prevent possible bodily injury

1. Read and follow directions supplied with the product (polishes, waxes, cleaners, etc.) being used.
2. Apply a small amount of product directly to the polishing pad.
3. Grasp polisher firmly with both hands, one hand on auxiliary handle and one hand on motor housing (see Fig. 3).
4. Position polisher with polishing pad against work surface and then start the polisher. NEVER run the polisher while the pad is not in contact with the work surface: always start and stop polisher while the pad is in contact with the work surface.
5. Move polisher back and forth in a sweeping motion, overlapping each pass with the previous.



6. DO NOT apply additional pressure, allow the polisher to work under its own weight.
7. Do not mix products (wax, polish, cleaner, etc.) on the same pad. Label each pad to prevent future confusion.
8. The polishing pad is designed for product application only. Remove product residue with a soft cotton towel.



Fig. 3

## INSTALLING/REMOVING ABRASIVE DISC

1. **⚠ WARNING** DISCONNECT TOOL FROM POWER SOURCE.
2. Place machine on workbench with pad up (See Fig. 4).

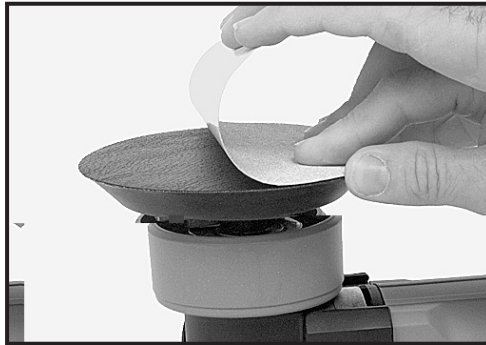

Fig. 4

3. Clean dust from pad face.
4. Tear a new abrasive disc from roll and position disc to the sander pad.
5. Press disc firmly onto pad.
6. Position machine with abrasive contacting scrap material. Start machine and operate momentarily while exerting firm pressure to seat disc to pad.

**⚠ WARNING** Failure to properly seat disc to pad may result in disc being thrown from pad causing personal injury.

7. To remove disc, peel disc away from pad.

**NOTE:** Do not store machine with an abrasive disc installed. Heat generated by the sanding operation increases the adhesive bond between the disc and pad. If disc is left on pad for an extended time after use, it can become difficult to remove.

## USING THE SANDER

1. **⚠ WARNING** Secure work to prevent it from moving during the sanding operation. Friction between the sanding disc and work will try to spin work away from sander and may cause bodily injury.



Fig. 5

2. **▲ WARNING** Wear ANSI Z87.1 safety glasses and dust mask.
3. Place sander to work (see Fig. 5) with abrasive disc resting FLAT on the work.

**NOTE:** The Random Orbit mechanism allows the sander to be started and stopped with the pad in contact with the work or clear of the work.

4. Grasp sander firmly and move switch to “ON” position.
5. Keep sanding disc FLAT on work and move sander in long overlapping strokes. Tipping sander or stopping in one spot can produce an uneven finish.
6. When finished, stop sander and allow pad rotation to stop completely before setting sander down.

### CHANGING BACK-UP PAD

1. **▲ WARNING** DISCONNECT TOOL FROM POWER SOURCE.
2. Position spindle wrench (A), Fig. 6, (furnished with tool) to engage the flats on the spindle (B), Fig. 6.

#### NOTES:

- A. It may be necessary to rotate the pad (by hand) to expose the spindle flats.
  - B. Fig. 6 shows tool with pad removed for clarity.
  - C. A spacer (not shown) has been supplied with the 7336SP and 7424 to add space for the backup pad to clear the eccentric plate screws (C) Fig. 6. Remove the spacer from the package and mount it on the shaft before applying the backup pad.
3. While holding the spindle with the wrench, rotate the pad counterclockwise (by hand) to remove.
  4. To install pad, reverse the above procedure.

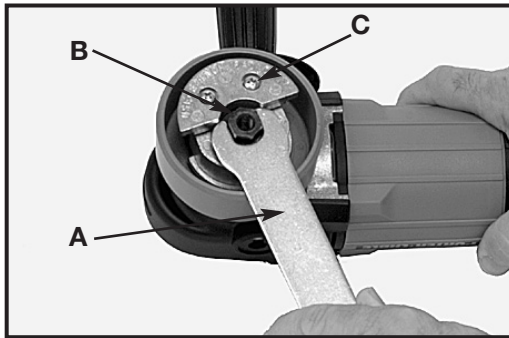

Fig. 6

## MAINTENANCE

### KEEP TOOL CLEAN

Periodically blow out all air passages with dry compressed air. All plastic parts should be cleaned with a soft damp cloth. NEVER use solvents to clean plastic parts. They could possibly dissolve or otherwise damage the material.

**⚠ WARNING** Wear ANSI Z87.1 safety glasses while using compressed air.

### FAILURE TO START

Should your tool fail to start, check to make sure the prongs on the cord plug are making good contact in the outlet. Also, check for blown fuses or open circuit breakers in the line.

### LUBRICATION

This tool has been lubricated with a sufficient amount of high grade lubricant for the life of the unit under normal operating conditions. No further lubrication is necessary.

### BRUSH INSPECTION AND LUBRICATION

For your continued safety and electrical protection, brush inspection and replacement on this tool should ONLY be performed by an AUTHORIZED PORTER-CABLE SERVICE STATION or a PORTER-CABLE•DELTA FACTORY SERVICE CENTER.

At approximately 100 hours of use, take or send your tool to your nearest authorized Porter-Cable Service Station to be thoroughly cleaned and inspected. Have worn parts replaced and lubricate with fresh lubricant. Have new brushes installed, and test the tool for performance.

Any loss of power before the above maintenance check may indicate the need for immediate servicing of your tool. DO NOT CONTINUE TO OPERATE TOOL UNDER THIS CONDITION. If proper operating voltage is present, return your tool to the service station for immediate service.

## SERVICE AND REPAIRS

All quality tools will eventually require servicing or replacement of parts due to wear from normal use. These operations, including brush inspection and replacement, should ONLY be performed by either an AUTHORIZED PORTER-CABLE SERVICE STATION or a PORTER-CABLE•DELTA FACTORY SERVICE CENTER. All repairs made by these agencies are fully guaranteed against defective material and workmanship. We cannot guarantee repairs made or attempted by anyone other than these agencies.

Should you have any questions about your tool, feel free to write us at any time. In any communications, please give all information shown on the nameplate of your tool (model number, type, serial number, etc.).

## ACCESSORIES

A complete line of accessories is available from your Porter-Cable•Delta Supplier, Porter-Cable•Delta Factory Service Centers, and Porter-Cable Authorized Service Stations. Please visit our Web Site [www.porter-cable.com](http://www.porter-cable.com) for a catalog or for the name of your nearest supplier.

### **▲ WARNING**

Since accessories other than those offered by Porter-Cable •Delta have not been tested with this product, use of such accessories could be hazardous. For safest operation, only Porter-Cable•Delta recommended accessories should be used with this product.

## PORTER-CABLE LIMITED ONE YEAR WARRANTY

Porter-Cable warrants its Professional Power Tools for a period of one year from the date of original purchase. We will repair or replace at our option, any part or parts of the product and accessories covered under this warranty which, after examination, proves to be defective in workmanship or material during the warranty period. For repair or replacement return the complete tool or accessory, transportation prepaid, to your nearest Porter-Cable Service Center or Authorized Service Station. Proof of purchase may be required. This warranty does not apply to repair or replacement required due to misuse, abuse, normal wear and tear or repairs attempted or made by other than our Service Centers or Authorized Service Stations.

ANY IMPLIED WARRANTY, INCLUDING THE IMPLIED WARRANTIES OF MERCHANTABILITY AND FITNESS FOR A PARTICULAR PURPOSE, WILL LAST ONLY FOR ONE (1) YEAR FROM THE DATE OF PURCHASE.

To obtain information on warranty performance please write to: PORTER-CABLE CORPORATION, 4825 Highway 45 North, Jackson, Tennessee 38305; Attention: Product Service. THE FOREGOING OBLIGATION IS PORTER-CABLE'S SOLE LIABILITY UNDER THIS OR ANY IMPLIED WARRANTY AND UNDER NO CIRCUMSTANCES SHALL PORTER-CABLE BE LIABLE FOR ANY INCIDENTAL OR CONSEQUENTIAL DAMAGES. Some states do not allow limitations on how long an implied warranty lasts or the exclusion or limitation of incidental or consequential damages, so the above limitation or exclusion may not apply to you.

This warranty gives you specific legal rights and you may also have other legal rights which vary from state to state.

# PORTER-CABLE • DELTA SERVICE CENTERS (CENTROS DE SERVICIO DE PORTER-CABLE • DELTA) (CENTRE DE SERVICE PORTER-CABLE • DELTA)

**Parts and Repair Service for Porter-Cable • Delta Power Tools are Available at These Locations  
(Obtenga Refaccion de Partes o Servicio para su Herramienta en los Siguietes Centros de Porter-Cable • Delta)  
(Locations où vous trouverez les pièces de rechange nécessaires ainsi qu'un service d'entretien)**

## ARIZONA

Tempe 85282 (Phoenix)  
2400 West Southern Avenue  
Suite 105  
Phone: (602) 437-1200  
Fax: (602) 437-2200

## CALIFORNIA

Ontario 91761 (Los Angeles)  
39494 East Guasti Road  
Phone: (909) 390-5555  
Fax: (909) 390-5554  
San Leandro 94577 (Oakland)  
3039 Teagarden Street  
Phone: (510) 357-9762  
Fax: (510) 357-7939

## COLORADO

Arvada 80003 (Denver)  
8175 Sheridan Blvd., Unit S  
Phone: (303) 487-1809  
Fax: (303) 487-1868

## FLORIDA

Davie 33314 (Miami)  
4343 South State Rd. 7 (441)  
Unit #107  
Phone: (954) 321-6635  
Fax: (954) 321-6638  
Tampa 33609  
4538 W. Kennedy Boulevard  
Phone: (813) 877-9585  
Fax: (813) 289-7948

Forest Park 30297 (Atlanta)  
5442 Frontage Road,  
Suite 112  
Phone: (404) 608-0006  
Fax: (404) 608-1123

## GEORGIA

Forest Park 30297 (Atlanta)  
5442 Frontage Road,  
Suite 112  
Phone: (404) 608-0006  
Fax: (404) 608-1123

## ILLINOIS

Addison 60101 (Chicago)  
400 South Rohlwing Rd.  
Phone: (630) 424-8805  
Fax: (630) 424-8895

## MARYLAND

Woodridge 60517 (Chicago)  
2033 West 75th Street  
Phone: (630) 910-9200  
Fax: (630) 910-0360

Elkridge 21075 (Baltimore)  
7574 Watson Road  
Phone: (410) 799-9394  
Fax: (410) 799-9398

## MASSACHUSETTS

Brantree 02185 (Boston)  
719 Granite Street  
Phone: (781) 848-9810  
Fax: (781) 848-6759

## MICHIGAN

Franklin 02038 (Boston)  
Franklin Industrial Park  
101E Constitution Blvd.  
Phone: (508) 520-8802  
Fax: (508) 528-8089

Madison Heights 48071 (Detroit)  
30475 Stephenson Highway  
Phone: (248) 597-5000  
Fax: (248) 597-5004

## MINNESOTA

Minneapolis 55429  
5522 Lakeland Avenue North  
Phone: (763) 561-9080  
Fax: (763) 561-0653

## MISSOURI

North Kansas City 64116  
1141 Swift Avenue  
Phone: (816) 221-2070  
Fax: (816) 221-2897

## NEW YORK

St. Louis 63119  
7574 Watson Road  
Phone: (314) 968-8950  
Fax: (314) 968-2790

175-25 Horace Harding Expwy.  
Phone: (718) 225-2040  
Fax: (718) 423-9619

## NORTH CAROLINA

Charlotte 28270  
9129 Monroe Road, Suite 115  
Phone: (704) 841-1176  
Fax: (704) 708-4625

## OHIO

Columbus 43214  
4560 Indianola Avenue  
Phone: (614) 263-9929  
Fax: (614) 263-1238

## OREGON

Cleveland 44125  
8001 Sweet Valley Drive  
Unit #19  
Phone: (216) 447-9030  
Fax: (216) 447-3097

## OREGON

Portland 97230  
4916 NE 122 nd Ave.  
Phone: (503) 252-0107  
Fax: (503) 252-2123

## PENNSYLVANIA

Willow Grove 19090  
520 North York Road  
Phone: (215) 658-1430  
Fax: (215) 658-1433

## TEXAS

Carrollton 75006 (Dallas)  
1300 Interstate 35 N, Suite 112  
Phone: (972) 446-2996  
Fax: (972) 446-8157

## HOUSTON 77038

4321 Sam Houston Parkway, West  
Suite 180  
Phone: (281) 260-8887  
Fax: (281) 260-9989

## WASHINGTON

Auburn 98001 (Seattle)  
3320 West Valley HWY, North  
Building D, Suite 111  
Phone: (253) 333-8353  
Fax: (253) 333-9613

Authorized Service Stations are located in many large cities. Telephone **800-487-8665** or **731-541-6042** for assistance locating one. Parts and accessories for Porter-Cable • Delta products should be obtained by contacting any Porter-Cable • Delta Distributor, Authorized Service Center, or Porter-Cable • Delta Factory Service Center. If you do not have access to any of these, call **888-848-5175** and you will be directed to the nearest Porter-Cable • Delta Factory Service Center. Las Estaciones de Servicio Autorizadas están ubicadas en muchas grandes ciudades. Llame al **800-487-8665** o al **731-541-6042** para obtener asistencia a fin de localizar una. Las piezas y los accesorios para los productos Porter-Cable • Delta deben obtenerse poniéndose en contacto con cualquier distribuidor Porter-Cable • Delta, Centro de Servicio Autorizado o Centro de Servicio de Fábrica Porter-Cable • Delta. Si no tiene acceso a ninguna de estas opciones, llame al **888-848-5175** y le dirijirán al Centro de Servicio de Fábrica Porter-Cable • Delta más cercano. Des centres de service agréés sont situés dans beaucoup de grandes villes. Appelez au **800-487-8665** ou au **731-541-6042** pour obtenir de l'aide pour en repérer un. Pour obtenir des pièces et accessoires pour les produits Porter-Cable • Delta, s'adresser à tout distributeur Porter-Cable • Delta, centre de service agréé ou centre de service d'usine Porter-Cable • Delta. Si vous n'avez accès à aucun de ces centres, appeler le **888-848-5175** et on vous dirigera vers le centre de service d'usine Porter-Cable • Delta le plus proche.

## CANADIAN PORTER-CABLE • DELTA SERVICE CENTERS

### ALBERTA

Bay 6, 2520-23rd St. N.E.  
Calgary, Alberta  
T2E 8L2  
Phone: (403) 735-6166  
Fax: (403) 735-6144

### BRITISH COLUMBIA

8520 Baxter Place  
Burnaby, B.C.  
V5A 4T8  
Phone: (604) 420-0102  
Fax: (604) 420-3522

### MANITOBA

1699 Dublin Avenue  
Winnipeg, Manitoba  
R3H 0H2  
Phone: (204) 633-9259  
Fax: (204) 632-1976

### ONTARIO

505 Southgate Drive  
Guelph, Ontario  
N1H 6M7  
Phone: (519) 767-4132  
Fax: (519) 767-4131

### QUÉBEC

1515 Ave.  
St-Jean Baptiste, Suite 180  
Québec, Québec  
G2E 5E2  
Phone: (418) 877-7112  
Fax: (418) 877-7123

1447, Begin  
St-Laurent, (Montréal), Québec  
H4R 1V8  
Phone: (514) 336-8772  
Fax: (514) 336-3505

The following are trademarks of PORTER-CABLE • DELTA (Las siguientes son marcas registradas de PORTER-CABLE • DELTA S.A.) (Les marques suivantes sont des marques de fabricant de la PORTER-CABLE • DELTA): Auto-Set®, BAMMER®, B.O.S.S.®, Builder's Saw®, Contractor's Saw®, Contractor's Saw II™, Delta®, DELTACRAFT®, DELTAGRAM™, Delta Series 2000™, DURATRAC™, Erc2™, FLEX®, Flying Chips™, FRAME SAW®, Homcraft®, INNOVATION THAT WORKS®, Jet-Lock®, JETSTREAM®, kickstand®, LASERLOC®, MICRO-SET®, Micro-Set™, MIDI LATHE®, MORTEN™, NETWORK™, OMNIJIG®, POCKET CUTTER®, PORTA-BAND®, PORTA-PLANE™, PORTER-CABLE®(design), PORTER-CABLE®PROFESSIONAL POWER TOOLS, Posi-Matic®, Q-3®(design), QUICKSAND®(design), QUICKSET™, QUICKSET II®, QUICKSET PLUS™, RIPTIDE™(design), SAFE GUARD II®, SAFE-LOCK®, Sanding Center®, SANDTRAP®(design), SAW BOSS®, Sawbuck™, Sidekick®, SPEED-BLOC®, SPEEDMATIC®, SPEEDTRONIC®, STAIR EASE®, The American Woodshop®(design), The Lumber Company®(design), THE PROFESSIONAL EDGE®, THE PROFESSIONAL SELECT®, THIN-LINE™, TIGER®, TIGER CUB®, TIGER SAW®, TORQBUSTER®, TORQ-BUSTER™, TRU-MATCH™, TWIN-LITE®, UNIGUARD®, Unifence®, UNIFEEDER™, Unihand®, Uniplane™, Unirip®, Unisaw®, Univise®, Versa-Feeder®, VERSA-PLANE™, WHISPER SERIES®, WOODWORKER'S CHOICE™.

Trademarks noted with ™ and ® are registered in the United States Patent and Trademark Office and may also be registered in other countries. Las Marcas Registradas con el signo de ™ y ® son registradas por la Oficina de Registros y Patentes de los Estados Unidos y también pueden estar registradas en otros países. Marques déposées, indiquées par la lettre ™ et ®, sont déposées au Bureau des brevets d'invention et marquées par le signe de ™ et ®.

## Free Manuals Download Website

<http://myh66.com>

<http://usermanuals.us>

<http://www.somanuals.com>

<http://www.4manuals.cc>

<http://www.manual-lib.com>

<http://www.404manual.com>

<http://www.luxmanual.com>

<http://aubethermostatmanual.com>

Golf course search by state

<http://golfingnear.com>

Email search by domain

<http://emailbydomain.com>

Auto manuals search

<http://auto.somanuals.com>

TV manuals search

<http://tv.somanuals.com>