

INSTRUCTION MANUAL

ESPAÑOL: PÁGINA 27
FRANÇAISE : PAGE 51

DOVETAIL JIG

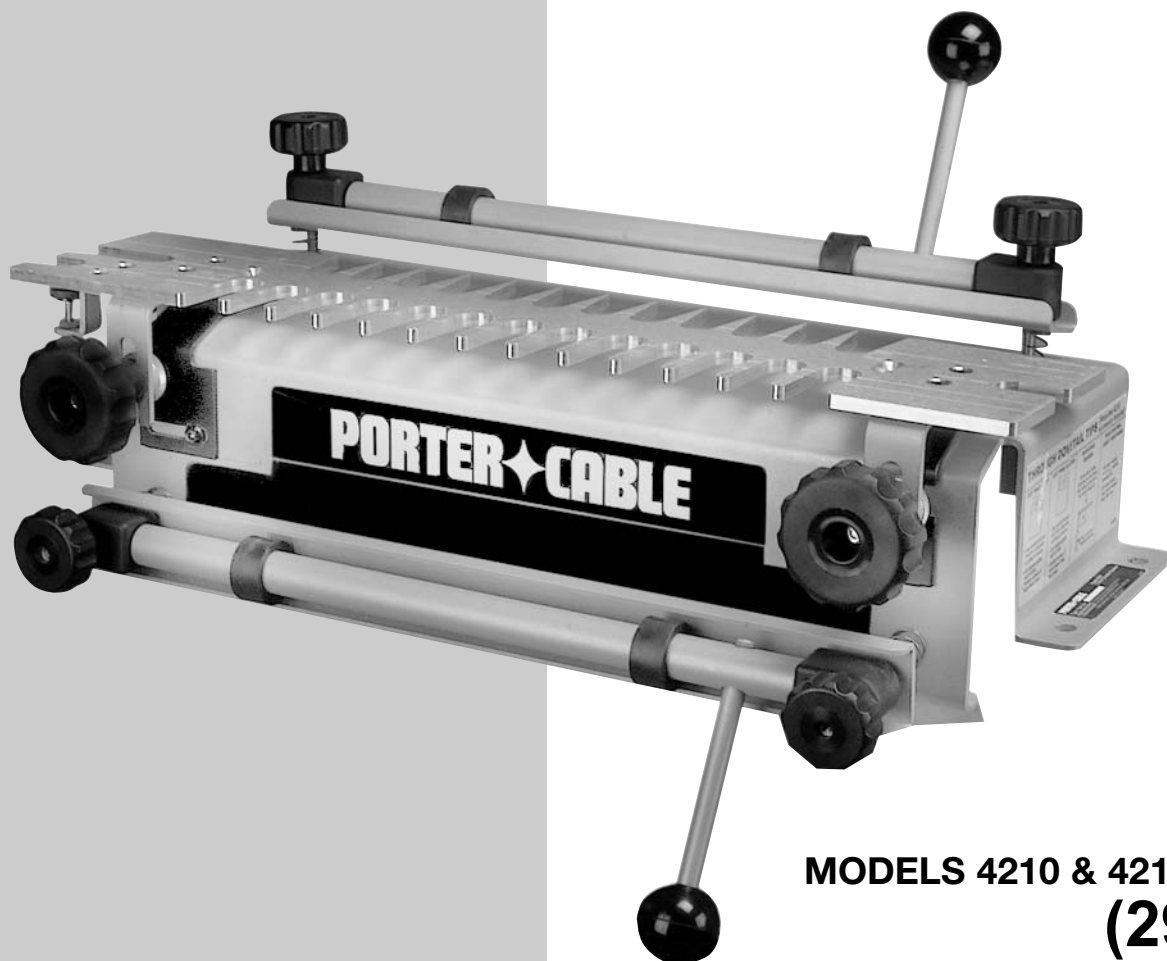

MODELS 4210 & 4212
(29550)

IMPORTANT

Please make certain that the person who is to use this equipment carefully reads and understands these instructions before starting operations.

The Model and Serial No. plate is located on the main housing of the tool. Record these numbers in the spaces below and retain for future reference.

Model No. _____

Type _____

Serial No. _____

To learn more about Porter-Cable
visit our website at:

<http://www.porter-cable.com>

PORTER-CABLE
PROFESSIONAL POWER TOOLS

TABLE OF CONTENTS

SAFETY GUIDELINES	3
IMPORTANT SAFETY INSTRUCTIONS	3
ADDITIONAL SPECIFIC SAFETY RULES	4
BACKGROUND INFORMATION	
Dovetail and Box Joint Overview	5
Product Capabilities	6
4200 Series Dovetail Jig Overview	7
Carton Contents	7
Assembly	8
Additional Tools Required	8
Mounting Instructions	8
OPERATION	
Clamps	9
Template Mounting	9
Template Support	10
Positioning the Wood	10
Half-Pins Vs. Half- Tails	11
Tearout Reduction	11
Aligning the Templates	11
Template Guides	12
Router Bit Depth	12
WOOD PREPARATION	
Grain Direction	13
Board Thickness	13
Optimal Board Widths	13
Board Lengths	13
Project Layout	14
Drawers	14
BASIC JOINTS	
Through Dovetails	15
Cutting the Tails	15
Cutting the Pins	16
Fitting and Troubleshooting	17
Half-Blind Dovetails	17
Cutting a Half-Blind Dovetail	17
Fitting and Troubleshooting	18
Half-Blind Dovetail with a Lipped Front	19
Cutting the Tails	19
Cutting the Pins	20
Fitting and Troubleshooting	20
Box Joints	21
Cutting the First workpiece	21
Cutting the Second Workpiece	22
Dovetail Dados (Sliding Dovetails)	23
Dado Board	23
Tenon Board	24
Fitting and Troubleshooting	24
MAINTENANCE	25
SERVICE	25
ACCESSORIES	25
WARRANTY	26
ESPAÑOL	27
FRANÇAISE	51
SERVICE CENTER LOCATIONS	Back cover

SAFETY GUIDELINES - DEFINITIONS

This manual contains information that is important for you to know and understand. This information relates to protecting YOUR SAFETY and PREVENTING EQUIPMENT PROBLEMS. To help you recognize this information, we use the symbols to the left. Please read the manual and pay attention to these sections.

- ▲ DANGER** Indicates an imminently hazardous situation which, if not avoided, will result in death or serious injury.
- ▲ WARNING** Indicates a potentially hazardous situation which, if not avoided, could result in death or serious injury.
- ▲ CAUTION** Indicates a potentially hazardous situation which, if not avoided, may result in minor or moderate injury.
- CAUTION** Used without the safety alert symbol indicates potentially hazardous situation which, if not avoided, may result in property damage.

IMPORTANT SAFETY INSTRUCTIONS



▲ WARNING Read and understand all instructions. Failure to follow all instructions listed below, may result in electric shock, fire and/or serious personal injury.

SAVE THESE INSTRUCTIONS.

▲ WARNING There are certain applications for which this tool was designed. Porter-Cable strongly recommends that this tool NOT be modified and/or used for any application other than for which it was designed. If you have any questions relative to its application DO NOT use the tool until you have written Porter-Cable and we have advised you.

Technical Service Manager
Porter-Cable Corporation
4825 Highway 45 North
Jackson, TN 38305

1. **KEEP WORK AREA CLEAN.** Cluttered areas and benches invite injuries.
2. **AVOID DANGEROUS ENVIRONMENT.** Don't expose power tools to rain. Don't use power tools in damp or wet locations. Keep area well lit. Avoid chemical or corrosive environment. Do not use tool in presence of flammable liquids or gases.
3. **GUARD AGAINST ELECTRIC SHOCK.** Prevent body contact with grounded surfaces. For example: pipes, radiators, ranges, refrigerator enclosures.
4. **KEEP CHILDREN AWAY.** Do not let visitors contact tool or extension cord. All visitors should be kept away from work area.
5. **STORE IDLE TOOLS.** When not in use, tools should be stored in dry, and high or locked-up place – out of reach of children.
6. **DON'T FORCE TOOL.** It will do the job better and safer at the rate for which it was intended.
7. **USE RIGHT TOOL.** Don't force small tool or attachment to do the job of a heavy duty tool. Don't use tool for purpose not intended – for example – do not use a circular saw for cutting tree limbs or logs.
8. **DRESS PROPERLY.** Do not wear loose clothing or jewelry. Loose clothing, draw strings and jewelry can be caught in moving parts. Rubber gloves and non-skid footwear are recommended when working outdoors. Wear protective hair covering to contain long hair.
9. **USE ANSI Z87.1 SAFETY GLASSES.** Wear safety glasses or goggles while operating power tools. Also face or dust mask if operation creates dust. All persons in the area where power tools are being operated should also wear safety glasses and face or dust mask.
10. **DON'T ABUSE CORD.** Never carry tool by cord or yank it to disconnect from receptacle. Keep cord from heat, oil, and sharp edges. Have damaged or worn power cord and strain reliever replaced immediately. **DO NOT ATTEMPT TO REPAIR POWER CORD.**
11. **SECURE WORK.** Use clamps or a vise to hold work. It's safer than using your hand and it frees both hands to operate tool.
12. **DON'T OVERREACH.** Keep proper footing and balance at all times.
13. **MAINTAIN TOOLS WITH CARE.** Keep tools sharp and clean for better and safer performance. Follow instructions for lubricating and changing accessories. Inspect tool cords periodically and if damaged, have repaired by authorized service facility. Inspect extension cords periodically and replace if damaged. Have all worn, broken or lost parts replaced immediately. Keep handles dry, clean and free from oil and grease.
14. **DISCONNECT TOOLS** when not in use, before servicing, and when changing accessories such as blades, bits, cutters, etc.
15. **REMOVE ADJUSTING KEYS AND WRENCHES.** Form habit of checking to see that keys and adjusting wrenches are removed from the tool before turning it on.

16. **AVOID UNINTENTIONAL STARTING.** Do not carry a plugged-in tool with finger on switch. Be sure switch is off when plugging in. Keep hands, body and clothing clear of blades, bits, cutters, etc. when plugging in the tool.
17. **OUTDOOR USE EXTENSION CORDS.** When tool is used outdoors, use only extension cords marked "Suitable for use with outdoor appliances – store indoors when not in use." If an extension cord is to be used outdoors it must be marked with the suffix W-A or w following the cord type designation.
18. **STAY ALERT.** Watch what you are doing. Use common sense. Do not operate tool when you are tired or while under the influence of medication, alcohol or drugs.
19. **CHECK DAMAGED PARTS.** Before further use of the tool, a guard or other part that is damaged should be carefully checked to determine that it will operate properly and perform its intended function. Check for alignment of moving parts, binding of moving parts, breakage of parts, mounting, and any other conditions that may affect its operation. A guard or other part that is damaged should be properly repaired or replaced by an authorized service center unless otherwise indicated elsewhere in this instruction manual. Have defective switches replaced by authorized service center. Do not use tool if switch does not turn it on and off.
20. **WEAR ANSI S3.19 EAR PROTECTION** to safeguard against possible hearing loss.

ADDITIONAL SAFETY RULES

⚠ WARNING FAILURE TO FOLLOW THESE RULES MAY RESULT IN SERIOUS PERSONAL INJURY.

1. **READ AND FOLLOW ALL SAFETY INSTRUCTIONS** in the instruction manual supplied with your router.
2. **SECURE WORK.** Be sure Dovetail Fixture/Jig and work is anchored securely to prevent movement.
3. **BE SURE CORD SET IS FREE** and will not hang up during routing operations.
4. **KEEP HANDS CLEAR** of cutter when motor is running to prevent personal injury.
5. **MAINTAIN FIRM GRIP** on router when starting motor to resist starting torque.
6. **STAY ALERT** and keep cutter free, clear of all foreign objects while motor is running.
7. **BE SURE MOTOR HAS COMPLETELY STOPPED** before removing router from Dovetail Fixture/Jig and setting Dovetail Fixture/Jig down between operations.
8. **NEVER REMOVE ROUTER MOTOR** from router base while template guide and dovetail bit are installed. dovetail bit may not fit through hole in template guide.
9. **TIGHTEN TEMPLATE GUIDE LOCKNUT SECURELY.**
10. **SOME WOOD CONTAINS PRESERVATIVES WHICH CAN BE TOXIC.** Take extra care to prevent inhalation and skin contact when working with these materials. Request, and follow, any safety information available from your material supplier.

REPLACEMENT PARTS

When servicing use only identical replacement parts.

BACKGROUND INFORMATION

DOVETAIL AND BOX JOINT OVERVIEW

The dovetail joint is a traditional joint that is both strong and visually appealing. This joint has flared protrusions (tails) that are cut into one board (drawer side) and protrusions with slanted sides (pins) that are cut in the other board (drawer front or back). When the two pieces are joined, the tails and pins lock together mechanically, so that pulling on the drawer front will pull the drawer side as well without the need for fasteners (screws, nails, etc.). Since the pins and tails have a sufficient amount of surface, the joint is even made stronger by glue.

Types of dovetails include through dovetails, half-blind dovetails, rabbeted half-blind dovetails, mitered-through dovetails, blind dovetails, and mitered dovetails. Of these joints, the through, half-blind, and rabbeted half-blind are the most common.

NOTE: This manual includes instruction for the basic dovetail jig operations. Please visit our Web Site at www.porter-cable.com/jigs for the supplementary manual that gives instruction for more advanced procedures.

THROUGH DOVETAILS

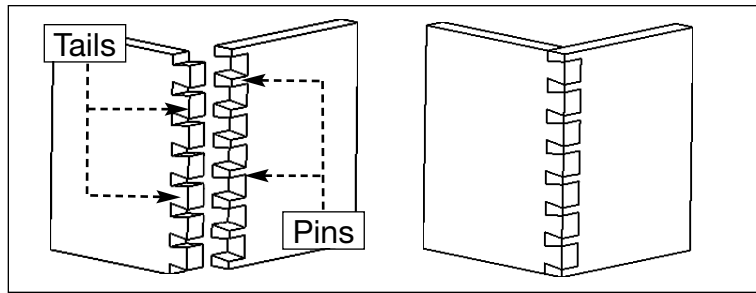

HALF-BLIND DOVETAILS

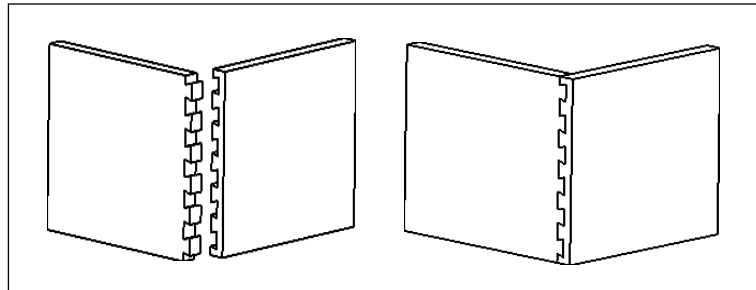

RABBETED HALF-BLIND DOVETAILS

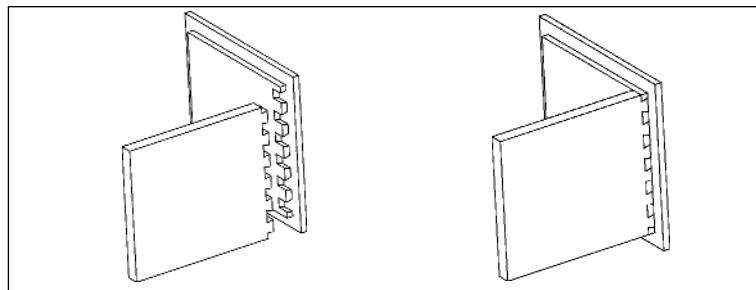

BOX (FINGER) JOINT

A similar joint, called a box or finger joint, has straight protrusions called fingers on both boards. This joint is used on jewelry boxes and other small boxes. The box joint is strong because it has a large surface area for glue.

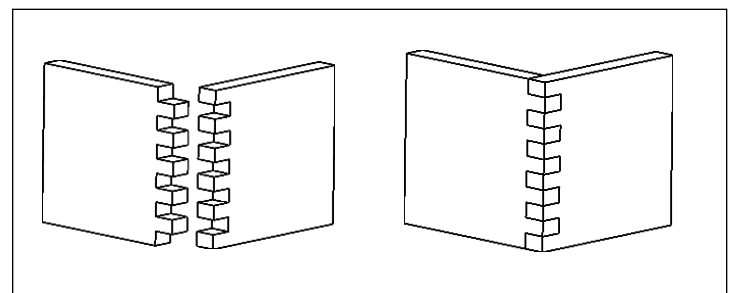

DOVETAIL DADO (SLIDING DOVETAIL)

The Dovetail Dado, or Sliding Dovetail, consists of a dovetail-shaped dado in one board and a dovetail-shaped tenon in the other board. This method is a strong way of connecting fixed shelves to walls.

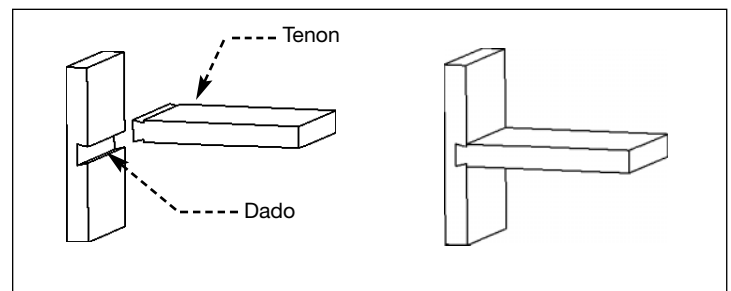

PRODUCT CAPABILITIES

The Porter-Cable 4200 series dovetail jig will help you cut these joints efficiently. An accessory kit will enable you to cut miniature versions of these joints for small gift boxes or cubbyhole drawers on a roll-top desk. The 4200 series also has the capability to cut more advanced joints (dovetails that skip pins, wood hinges, end-to-end joints, various types of angle joints, and joints with inlays).

The specific model capabilities are:

Jigs

- 4210 Dovetail Jig - half-blind, half-blind with a lipped front, and dovetail dados.
- 4212 Deluxe Dovetail Jig - through dovetail, box joint, half-blind, half-blind with a lipped front, and dovetail dados.

Accessories

- 4211 Accessory Kit - includes the template, router bit, and templet guide included with the model 4210.
- 4213 Accessory kit - includes all items necessary to provide the 4210 jig with the same capabilities as the 4212 deluxe dovetail jig.
- 4215 Accessory kit - contains the template, router bits, and templet guides to make miniature through dovetails and half-blind dovetails.

JIG OVERVIEW

The 4200 series dovetail jigs come equipped with an easy-to-mount, heavy-duty steel base (A) Fig. A1 featuring a clamping system designed to hold wood and minimize board slippage during cuts. Troubleshooting tips (B) are provided on each side of the base. Three different machined aluminum templates (Fig. A2) can be used on the jig system to create all joints described in this manual. The fingers on each template are used in combination with the template guides (Fig. A3) to guide the router in the proper motion. Additionally, each template aids in setting proper board alignment and router bit depth. Dovetail bits and straight bits (Figs. A4 and A5) are used with this jig system.

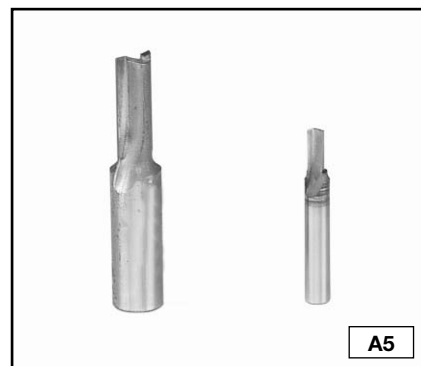
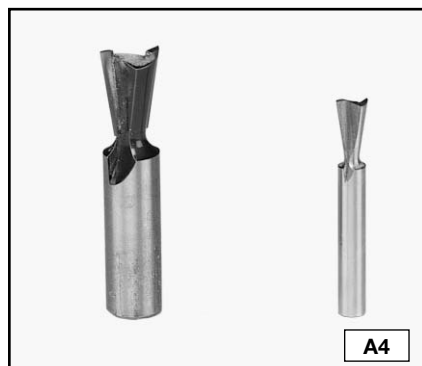
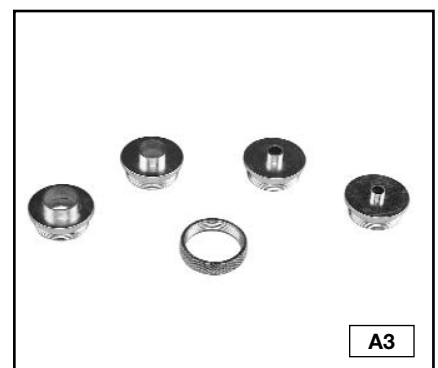
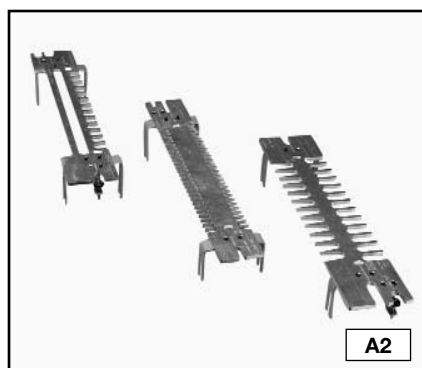
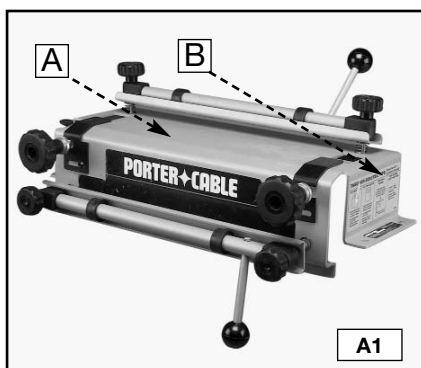

CARTON CONTENTS

4210

DOVETAIL JIGS

4212

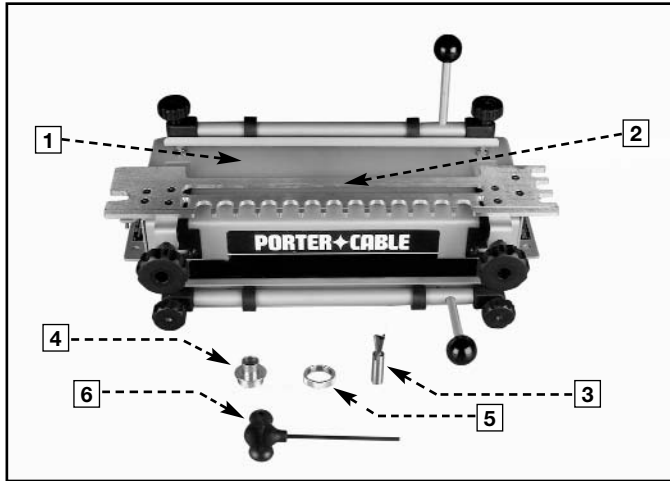

1. Base
2. Half-blind & Dado Template
3. Dovetail Bit
4. Template Guide
5. Lock nut
6. T-handle Hex Wrench

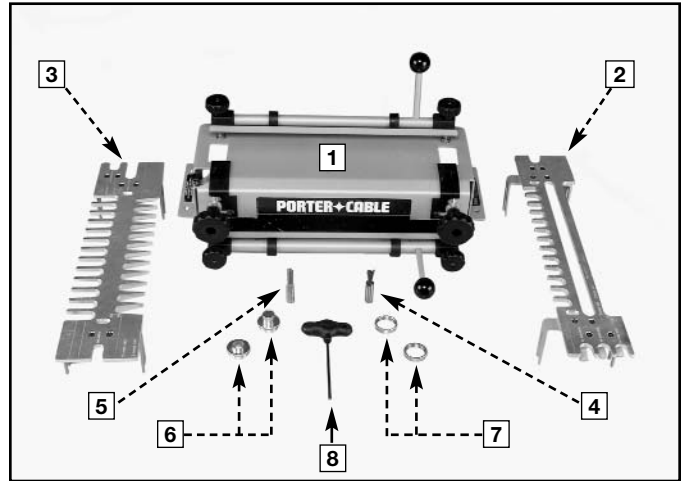

1. Base
2. Half-blind & Dado Template
3. Through & Box Template
4. Dovetail Bit
5. Straight Bit
6. Template Guide (2)
7. Lock Nuts (2)
8. T-handle Hex Wrench

ACCESSORY KITS

4211

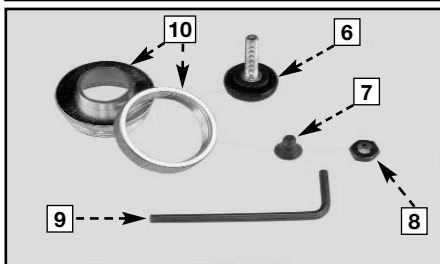
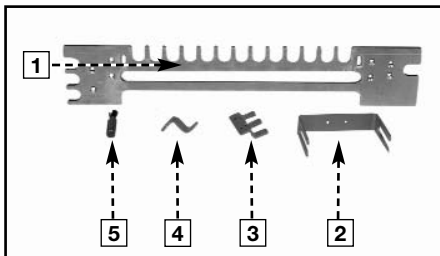

1. Half-blind & Dado Template
2. Brackets (2)
3. Dado Depth Bracket
4. Half-blind Depth Bracket
5. Dovetail Bit
6. Depth Knob
7. Screws (8)
8. Hex Nuts (1)
9. Wrench
10. Template Guide and Lock Nut

4213

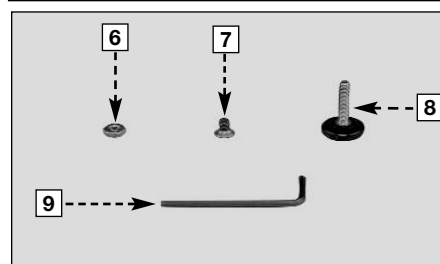
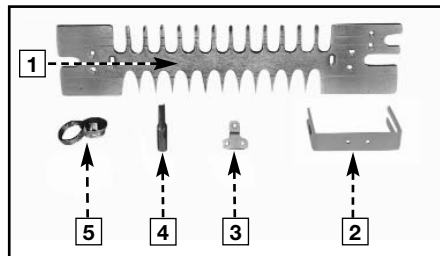

1. Through and Box Joint Template
2. Brackets (2)
3. Half-Blind Depth Bracket
4. Straight Bit
5. Template Guide and Lock Nut
6. Hex Nuts (1)
7. Screws (6)
8. Depth Knob
9. Wrench

4215

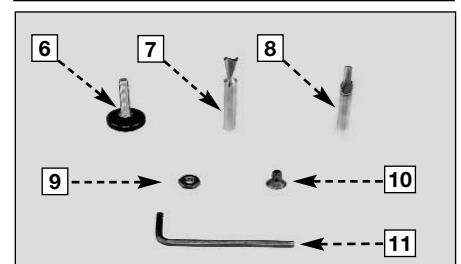
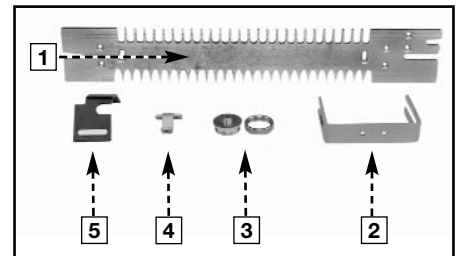

1. Miniature Half-blind, Through, & Box Template
2. Brackets (2)
3. Template Guide and Lock Nut (2)
4. Half-blind Depth Bracket
5. Offset Guide (2)
6. Depth Knob
7. Dovetail Bit
8. Straight Bit
9. Hex Nuts (1)
10. Screws (6)
11. Wrench

ASSEMBLY

The 4200 series dovetail jigs come fully assembled from the factory. However, the accessory templates (4211, 4213, 4215) require assembly. The supplied hex wrench can be used to attach the brackets and router bit depth guides to the template. A 3/8" wrench is required to adjust the height of the router bit depth guide.

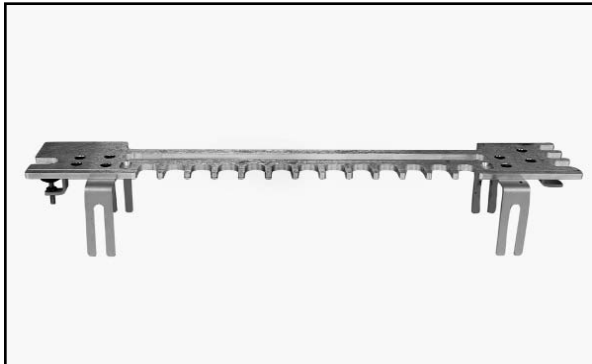

ASSEMBLED JIG

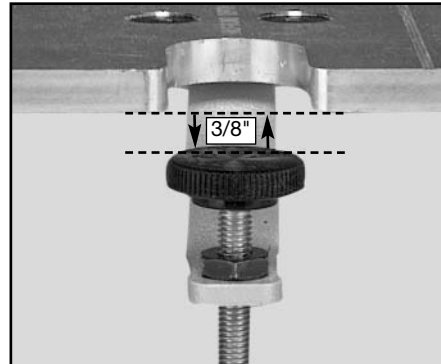

HEIGHT ADJUSTMENT

ADDITIONAL TOOLS REQUIRED

The router that you use with this jig

- ◆ must accept the Porter-Cable template guides supplied with the jig. (Adapters and sub-bases are available for most routers.)
- ◆ must have a 1/2" collet for use with 4210 and 4212 jigs and the 4211 and 4213 accessory kits.
- ◆ must have a 1/4" collet for use with the 4215 accessory kit.



NOTE: While the jigs and accessory kits include the router bits and template guides to make the basic dovetail joints, additional router bits are required to make box joints.

MOUNTING INSTRUCTIONS

NOTE: Always mount your jig to a solid work surface.

You can mount your jig permanently (Fig. B1) by using the pre-drilled holes (A) Fig B1) on each side of the base, or you can mount the base to your work surface using clamps (Fig. B2).

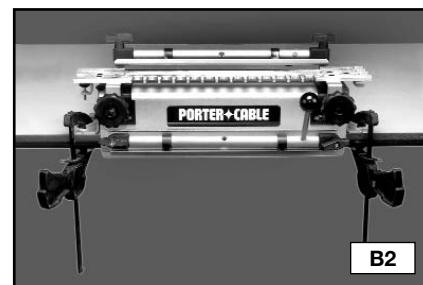
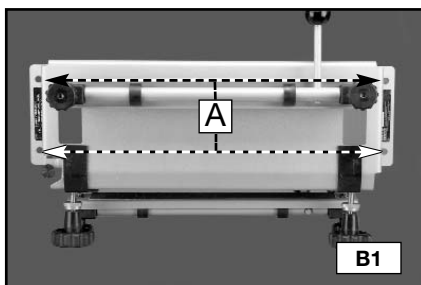

OPERATION

Mount your workpiece in the jig properly. If the workpiece is not secure, it can be damaged when it moves.

The jigs utilize two mounting positions for workpieces - horizontal and vertical. Some joints require both, while others require the use of a scrap board in the horizontal position (upper clamp) and the workpiece in the vertical position (lower clamp).

Position your workpiece correctly left-to-right to produce symmetrical and tight-fitting joints.

Tear-out from the router bit can be reduced when scrap wood is positioned properly against the workpiece.

CLAMPS

The 4200 series jigs are equipped with two cam-action clamps (A) Fig. C1 with knobs (B) to adjust for workpiece thickness, and levers (C) for quick clamping and releasing of workpieces.

NOTE: Use a scrap board (A) Fig. C2 to prevent misalignment (A) Fig. C3.

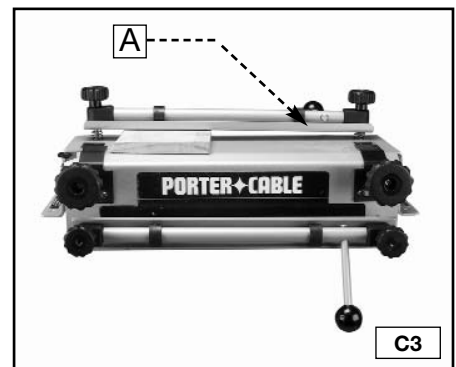
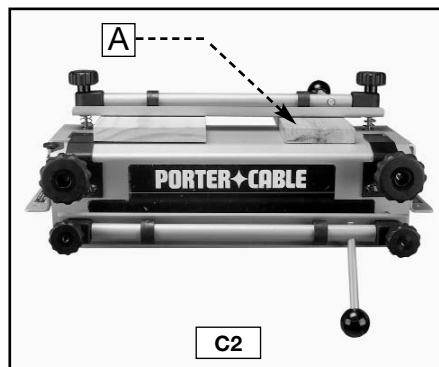
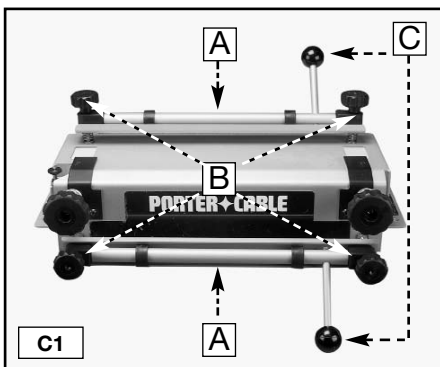

TEMPLATE MOUNTING

You can mount the templates in two positions on the jig(s) which allows the production of multiple types of joints with each template. To reverse a template, loosen the template knobs (C) Fig. D1, remove the template (B) from the base, rotate it 180 degrees horizontally, replace it on the base, and tighten the template knobs.

NOTE: Secure the templates by inserting the template brackets (A) Fig. D2 between the large template knobs (B) Fig. D2 and the brass adjustment knobs (C). You can then make front-to-back adjustments by loosening the large template knobs (B) and rotating the brass adjustment knobs (C).

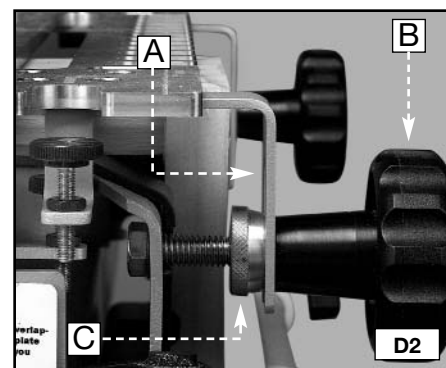
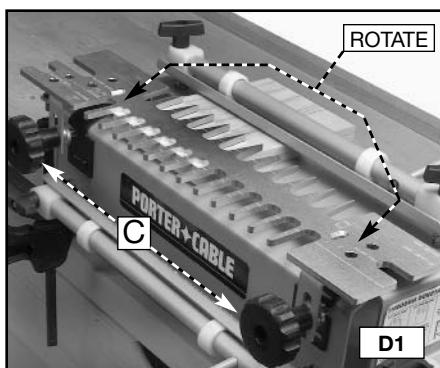

TEMPLATE SUPPORT

For every type of joint, place wood in the top clamp, whether a workpiece or a scrap piece, to provide support for the router on the template. You can add extra support by inserting a second board (A) Fig. E1 (of the same thickness) in the top clamp to ensure that the template is parallel to the base across its length. This practice works very well for narrow workpieces.

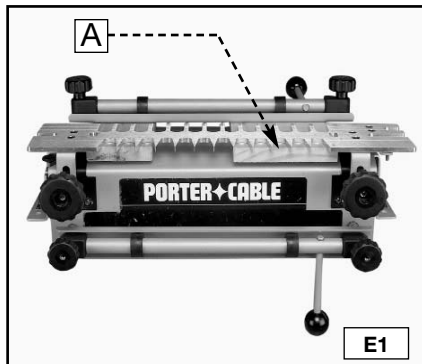

Supported



Unsupported

POSITIONING THE WOOD

You must position the workpiece correctly to produce attractive symmetrical joints. Use the offset guides to consistently position the workpiece for optimal alignment and symmetry.

- Step 1** - Clamp the workpiece (or spacer board) (A) Fig. F1 in the horizontal position. The position is not critical, but the workpiece must not extend beyond the front edge of the base.
- Step 2** - Mount the template (Fig. F2) on top of the horizontal workpiece. Press down on the template (A) with one hand, and tighten the template knobs with the other.
- Step 3** - Loosen the left offset guide (A) Fig. F3 with the T-handle hex wrench (B) and move it to the far left position.
- Step 4** - Align the vertical workpiece (A) Fig. F4 flush against the bottom side of the template. Center and clamp the workpiece between the farthest finger to the left and the nearest finger to the right of the template.
- Step 5** - Move the left offset guide (A) Fig. F5 to the right so that it is flush against the vertical workpiece (B). Tighten the left offset guide with the T-handle wrench (C).
- Step 6** - Unclamp the horizontal workpiece and slide it forward so that it is flush against the vertical workpiece and flush against the left offset guide (Fig. F6).

NOTE: The template has been removed for clarity.

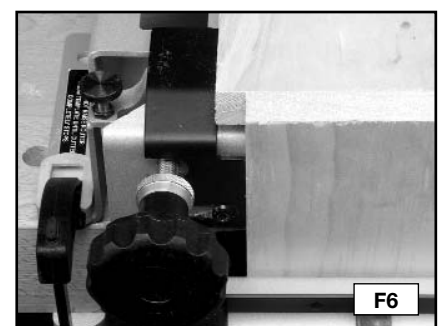
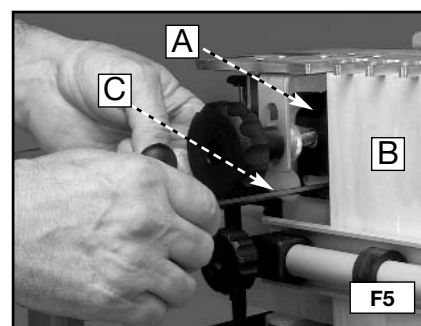
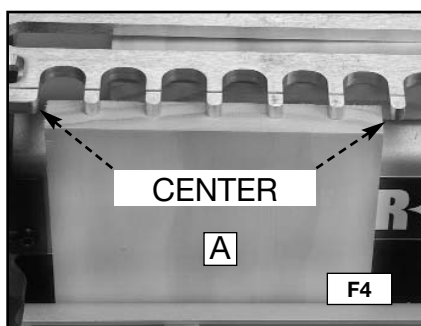
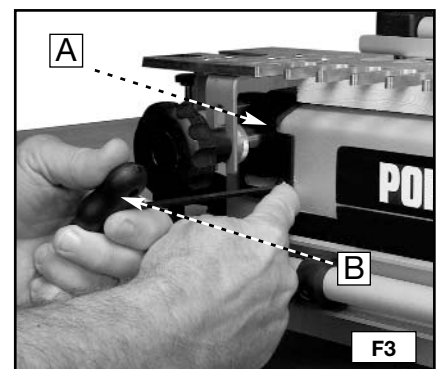
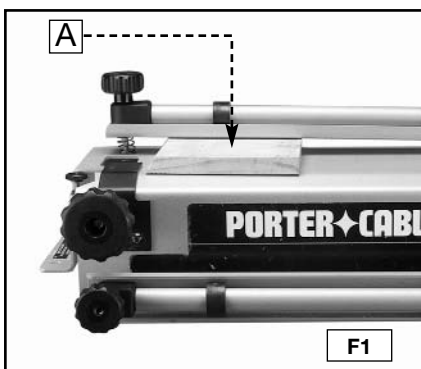

HALF-PINS VS. HALF-TAILS

Traditionally, dovetails have half-pins cut on both ends (Fig. G1). Half-tails will be just as strong, but will not be as attractive (Fig. G2). If your joints are half-tails and you want half-pins, move the vertical board 1/2" either left or right, then move the horizontal board accordingly. The procedure is the same with the 4215 Miniature template, except that you move the boards 1/4".

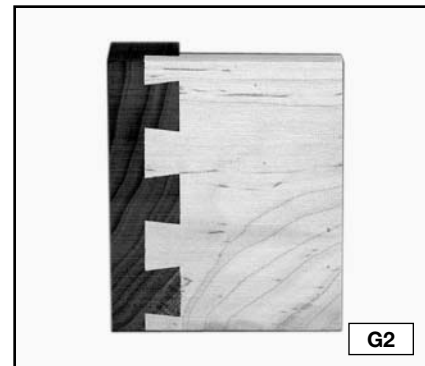
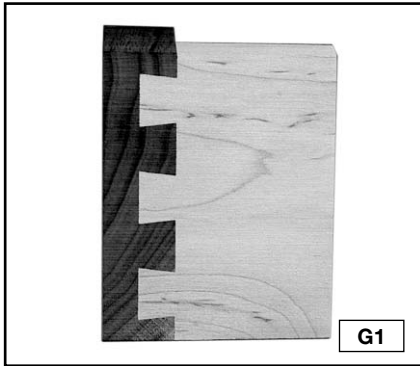

TEAROUT REDUCTION

Tearout is unwanted splintering of the wood fibers that occurs when a router bit enters, exits, or skims the edge of wood and is common to all dovetail jigs. Tearout cannot be eliminated, but it can be reduced by the insertion of additional scrap wood against the workpiece.

ALIGNING THE TEMPLATES

For proper operation, you must align the templates correctly from front to back. The 4200 series jigs have patented alignment lines to help you align the templates without measuring. Some templates have one line (Fig. H1) while others have several lines to produce multiple types of joints (Fig. H2). Porter-Cable has scribed icons on the templates to indicate which lines go with which joints.

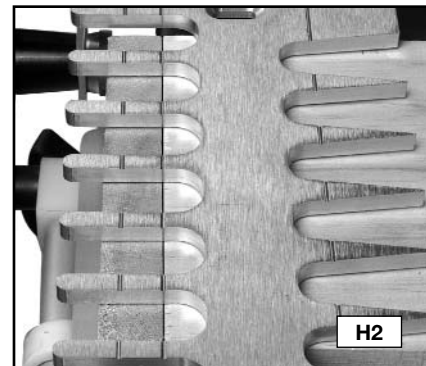
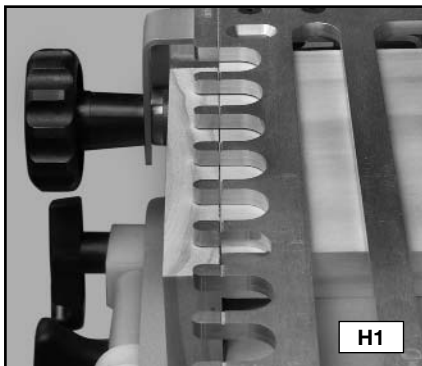

Adjust the templates front-to-back until the alignment line is directly over the point where the horizontal board and the vertical board meet.

NOTE: To be accurate, lean over the template and look straight down to align the lines (Fig. H3).

For the joint to be produced correctly, loosen the knobs on both sides of the template, align the lines, hold the template flat with one hand, and tighten the knobs with the other (Fig. H4).

NOTE: To help align both ends of the template when you are using a narrow workpiece, mount an additional piece of wood (of the same thickness) on the far right (A) Fig. H5.

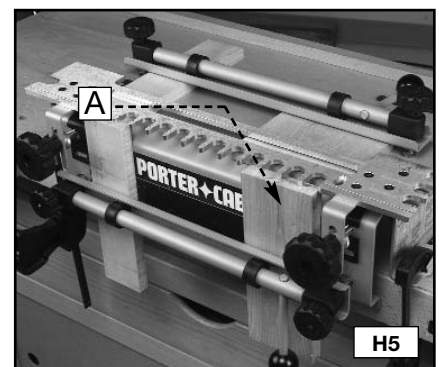

TEMPLATE GUIDES

Use the correct template guides provided with this unit to guide the router against the template fingers. To determine the proper guide for a given joint, place the template guide in the slot on the left side of the corresponding template. The guide should have a snug fit in the slot.

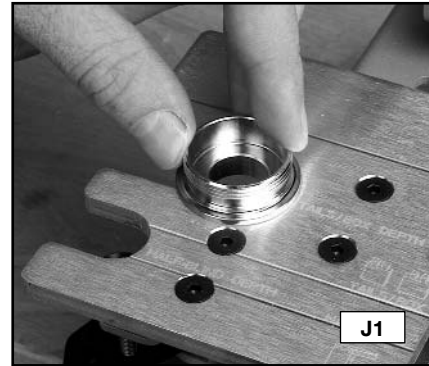

ROUTER BIT DEPTH

⚠ WARNING DISCONNECT THE ROUTER FROM THE POWER SOURCE BEFORE MAKING ANY CHANGES OR ADJUSTMENTS!

The depth-of-cut for the router bits is critical for a good-fitting joint. The 4200 series jigs have patented router bit depth guides that allow the user to quickly and easily set the bit to the correct depth without measuring.

Rest the router on the left side of the template and gently lower the router bit until it touches the guide. Multiple depth guides are provided on the jig because different joints require different depth settings.

NOTE: Attach the template guide (with the lock nut) and the bit to your router using the instructions in your router's operating manual.

- Step 1** - Lower the bit just past the edge of the template guide (Fig. K1).
- Step 2** - Use the slot with the corresponding scribed text on the template that matches the joint you will cut (Fig. K2).
- Step 3** - Place the router on the template with the guide and bit in the selected slot (Fig. K3).
- Step 4** - Lower the router bit (A) Fig. K4 on the depth guide (B) and lock the position on your router.

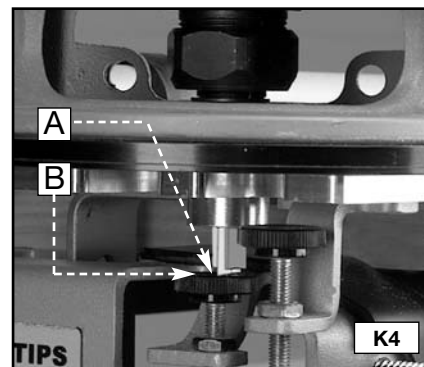
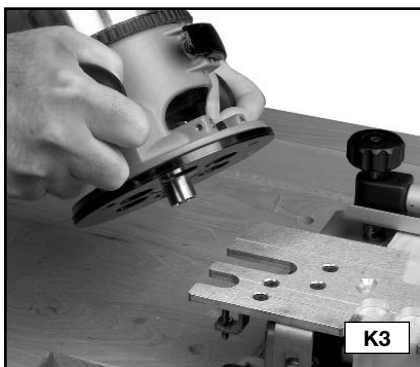
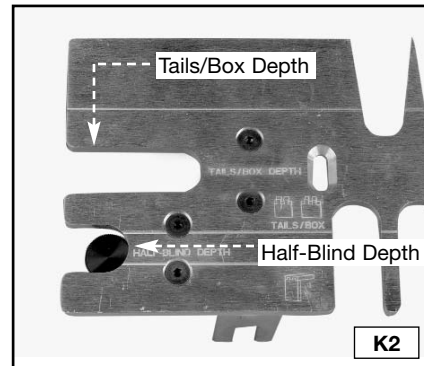
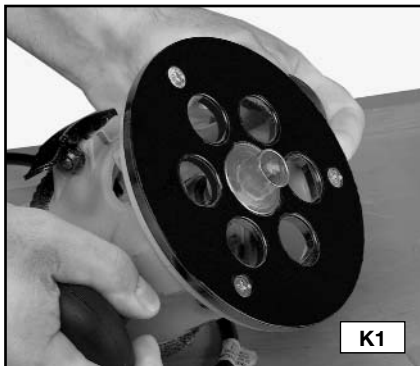

WOOD PREPARATION

Properly preparing the materials for your project is the key to good-looking and tight-fitting joints. You must cut your wood at perfect right angles (Fig. L1). Cuts that are off even one degree will not align correctly (Fig. L2). Also, your workpieces must be flat and not cupped.

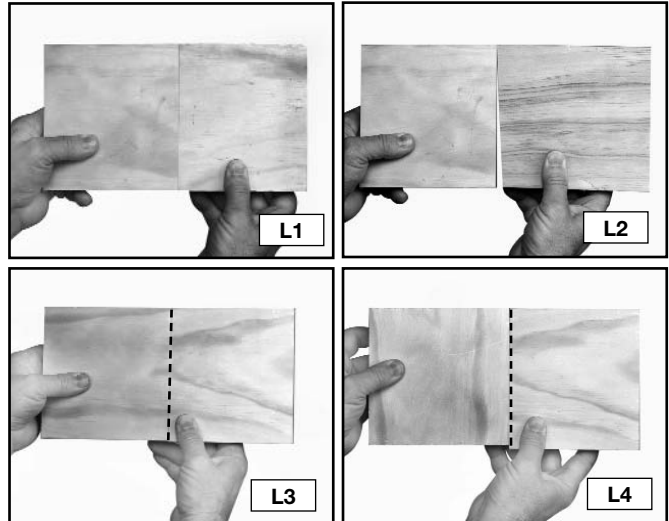

Orient your wood so that end grain is joined to end grain (Fig. L3) to make the joint strong. Using the long grain (Fig. L4) in the workpiece will result in a weak joint.

BOARD THICKNESS

NOTE: You can join two workpieces that are different thicknesses (Fig. M1).

The clamps on the 4200 series jigs will hold wood from 1/4" to 1-1/8" thick. Use the following information as a guide to help you decide the thickness of wood for your projects.

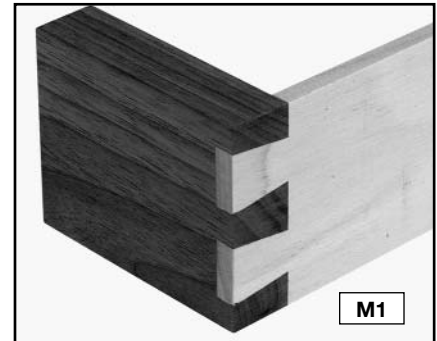

Standard through dovetails	Tail Board Range.....	1/4" to 1"
	Pin Board Range	1/4" to 3/4"
Miniature through dovetails.....	Both Tails and Pins.....	1/4" to 1/2"
Half-blind dovetails	Standard and Miniature	1/2" to 1-1/8"
Half-blind dovetail with a lipped front (Pin board will change depending on the size of the lip).		1/2" to 1-1/8"
Standard Box Joints (Limited by router bit length)		1/4" to 1-1/8"
Miniature Box Joints.....		1/4" to 1/2"
Dovetail Dados.....		1/4" to 1-1/8"

OPTIMAL BOARD WIDTHS

The 4200 series dovetail jigs are capable of making joints up to 12". However, some widths will produce a more attractive joint than others. The optimal widths for creating dovetails are in 1" increments plus 1/4" (1-1/4", 2-1/4", 3-1/4", etc.). Other widths will work, but will not be as attractive.

NOTE: If you are using the 4215 miniature accessory kit, the optimal widths are in 1/2" increments plus 1/8" (5/8", 1-1/8", 1-5/8", etc.).

BOARD LENGTHS

For through dovetails and box joints, cut your workpieces to the same length as the outside dimension of your final project. However, cut the drawer sides (tail board) of half-blind joints as indicated below because the wood does not go all the way through the joint.

To calculate the length of the half-blind tail board, take the inside dimension of the final project and add the router bit depth of cut. If the tail board has a half-blind on both ends, double the added dimension. The length of the pin boards (drawer front) remains the same.

PROJECT LAY OUT

Keeping track of the outer and inner face of each workpiece and how the different parts mate with each other is very important.

- Step 1** - Lay out the workpieces face down and label the inside faces with an "I" (Fig. N1).
- Step 2** - Label the corners "A", "B", "C", and "D" (Fig. N2).
- Step 3** - Label the tail boards (drawer sides) with a "T" (Fig. N3).
- Step 4** - Label the pin boards (drawer fronts) with a "P" (Fig. N4)

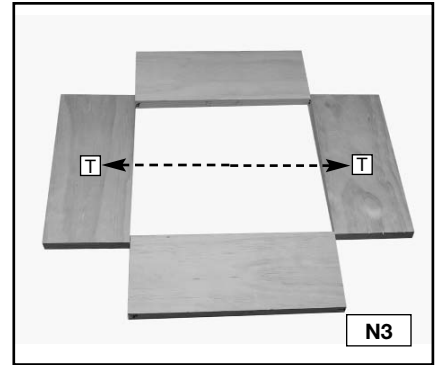
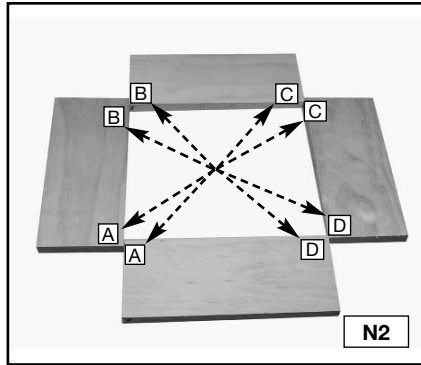
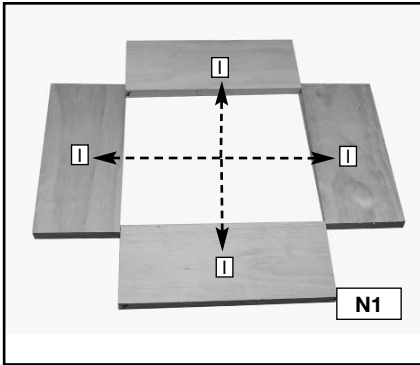

DRAWERS

Tips for making drawers:

Tails (A) Fig. O1 are cut into the sides of the drawers, while pins (B) Fig. O1 are cut into the fronts and backs of drawers.

You can use either solid wood or plywood for the drawer bottoms (A) Fig. O2. Insert the bottoms in a groove along the bottom of the fronts and sides. Allow the drawer bottom to be free-floating (without glue) to allow for seasonal expansion and contraction.

The grooves can go all the way to the ends of the boards if the joints are half-blind dovetails. To accomplish this, position the groove so that it runs through one of the tails on the side (Fig. O2). You will have to stop the grooves on through dovetails or box joints before they reach the end of the board to prevent them from being seen (Figs. O5 and O6).

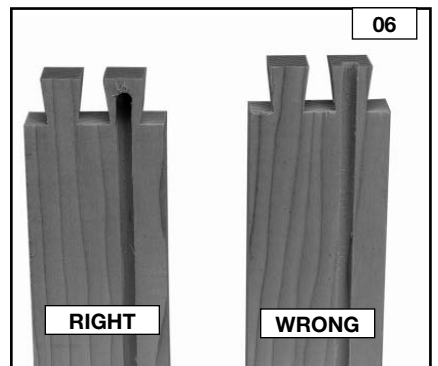
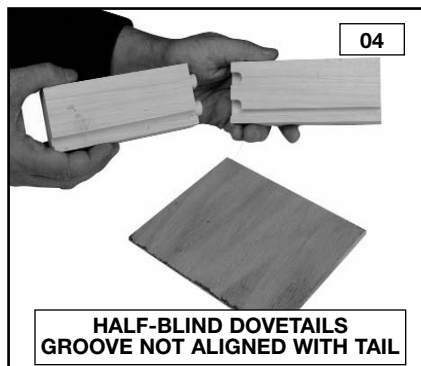
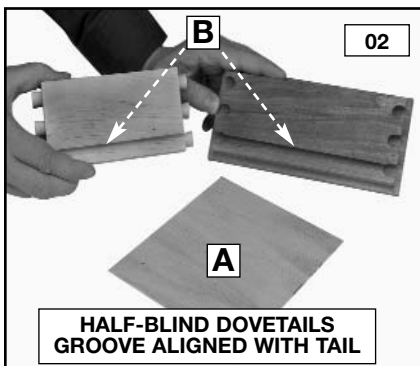
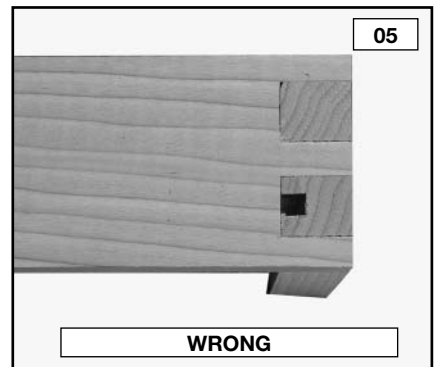
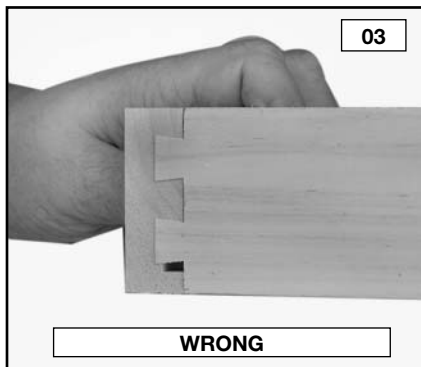
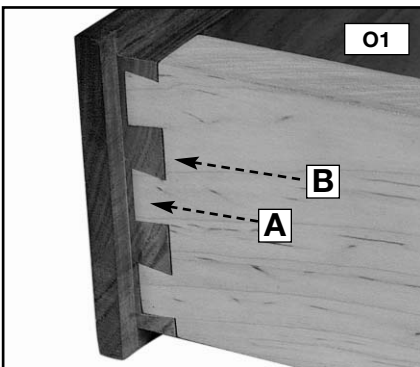
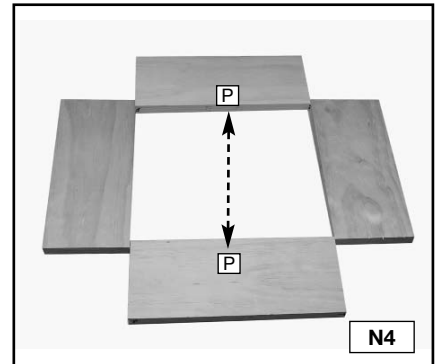

BASIC JOINTS

THROUGH DOVETAILS

The through dovetail has a look that is visually appealing, especially in boxes and chests.

NOTE: For miniature through dovetails, use the 4215 accessory kit.

Cut both the pins and tails in the vertical position.

Cut the tails first.

Use two routers (if possible) - one for the pins and the other for the tails - to make the process quicker and easier.

If you are using the 4210 dovetail jig, you will need the 4213 accessory kit to make this joint.

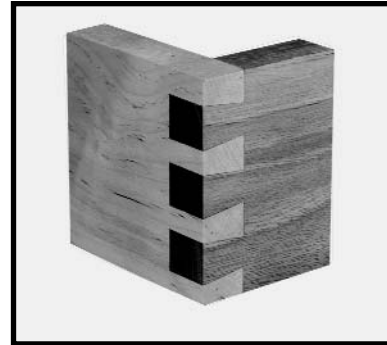

ITEMS NEEDED

- Through Dovetail and Box Joint Template
- 17/32", 7° Dovetail Bit 43776PC
- 13/32" Straight Bit, 43743PC
- 3/4" O.D. Template Guide, 42040 (with dovetail bit)
- 5/8" O.D. Template Guide, 42046 (with straight bit)
- Template Guide Lock Nut, 42239

ITEMS NEEDED FOR MINIATURE

- Miniature Dovetail Template
- 9/32", 7° Dovetail Bit 43777PC
- 3/16" Straight Bit, 43014PC
- 3/8" O.D. Template Guide, 42037 (with dovetail bit)
- 5/16" O.D. Template Guide, 42055 (with straight bit)
- Template Guide Lock Nut, 42239

CUTTING THE TAILS

Step 1 - Clamp a spacer board (A) Fig. P1 (equal to the thickness of your pinboard) in the upper clamp. Mount the through dovetail template (B) on the base with the "tails" side facing you.

Step 2 - Move the offset guide (A) Fig. P2 to the far left.

Step 3- Clamp the tailboard (A) Fig. P3 in the lower clamp with the outside surface of the board facing the jig. (See the section "**POSITIONING THE WOOD**" in this manual.)

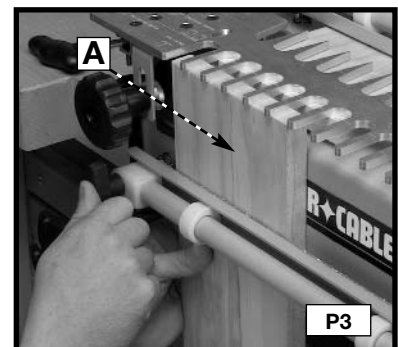
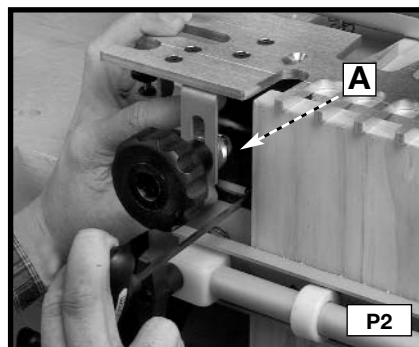
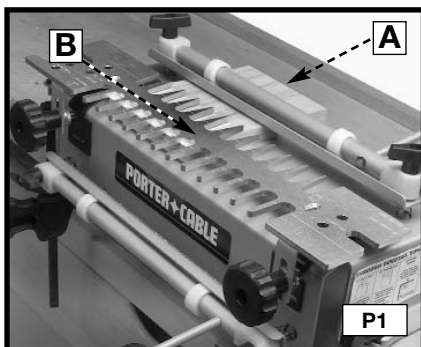

Step 4 - Reposition the offset guide (A) Fig. P4 flush to the vertical board and secure it.

Step 5 - Reposition the scrap board(A) Fig. P5 so that it is flush with the rear edge of the vertical board (B).

Step 6- Align the template using the "tails/box" line (A) Fig. P6 with the line formed where the scrap board (B) and the vertical board meet (C) and secure it.

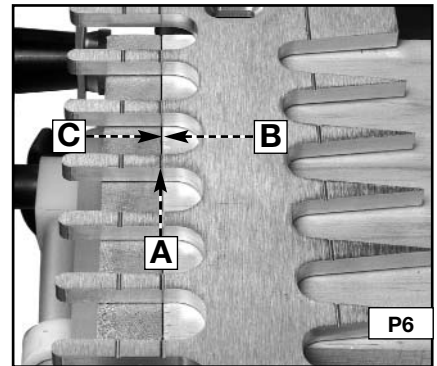
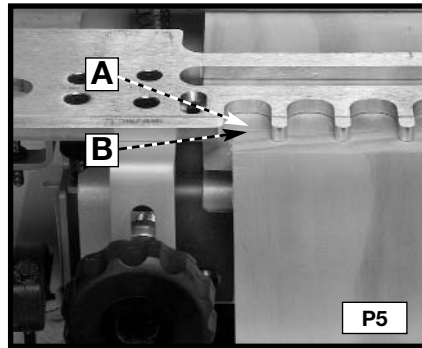
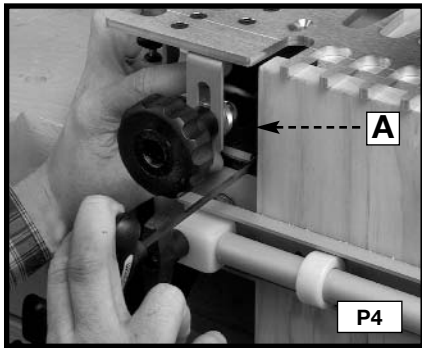

Step 7 - Mount the dovetail bit and 3/4" template guide on the router and set the router bit depth using the "tail/box" depth guide (A) Fig. P7.

Step 8 - Rout along the template fingers (Fig. P8). When the cut is complete, remove the vertical board.

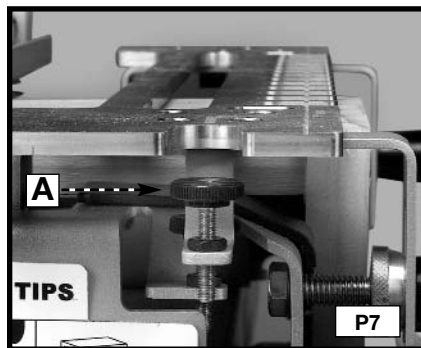

NOTE: If you prefer for your pins to protrude slightly for easier sanding, Adjust your router for a slightly deeper cut. Once your optimum depth has been achieved, adjust the bit height guide with a 3/8" wrench.

CUTTING THE PINS

NOTE: If the pin board is not the same thickness as the tail board, replace the scrap piece in the horizontal clamp with a scrap board the same thickness as your tail board.

Step 1- Remove the template and rotate it 180 degrees so that the "pins" side is facing you. Clamp the pin board in the lower clamp, flush against the left offset guide with the outside of the board facing away from the jig.

Step 2 - Align the "pins" line (see the arrows) Fig. P10 on the template with the line formed where the scrap board and pin board meet and tighten the template in place.

Step 3- Mount the straight bit and the 5/8" templet guide on the router and set the router bit depth using the "pins" bit depth guide (Fig. P11).

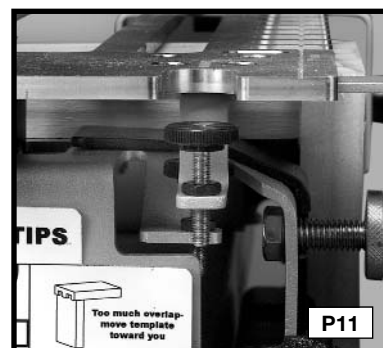
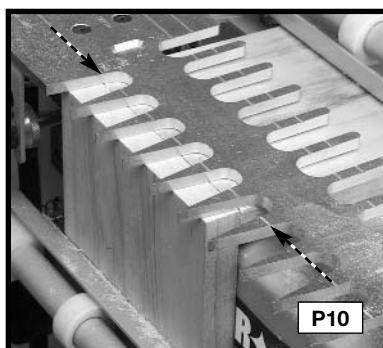

Step 5- Rout between the fingers of the template (Fig. P12).

Step 6 - Remove the pin board and check the fit with the tailboard (Fig. P13).

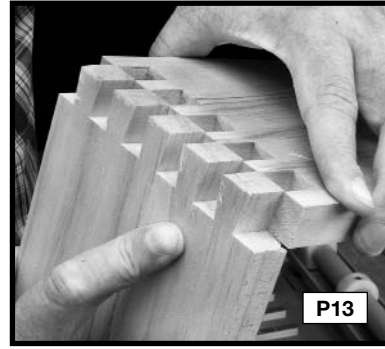

THROUGH DOVETAIL TROUBLESHOOTING

For joints that are too loose, move the template toward you slightly.
For joints that are too tight, move the template away from you slightly.

HALF-BLIND DOVETAILS

The half-blind dovetail is one of the most common types of joints and is the ideal choice for the drawer construction. In typical half-blind drawer construction, the joint is not visible from the front and is invisible when the drawer is closed.

NOTE: For miniature half-blinds, use the 4215 accessory kit.
Use scrap wood until you are comfortable with the jig.
You can cut half-blind pins and tails simultaneously on the 4200 series jigs.
Mount the correct offset guides - black for the standard and silver for the miniature.

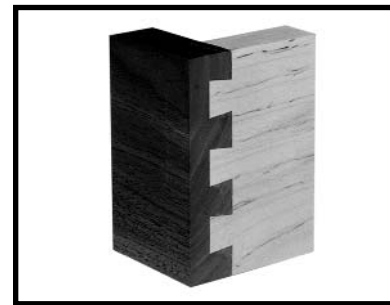

ITEMS NEEDED

- Half-blind Dovetail Template
- 17/32", 7° Dovetail Bit 43776PC
- 3/4" O.D. Template Guide, 42040
- Template Guide Lock Nut, 42239

ITEMS NEEDED FOR MINIATURE

- Miniature Dovetail Template
- 9/32", 7° Dovetail Bit 43777PC
- 3/8" O.D. Template Guide, 42037 (with dovetail bit)
- Template Guide Lock Nut, 42239
- Miniature Offset Guides (silver)

CUTTING HALF-BLIND DOVETAILS

Step 1 - Clamp the pin board (drawer front) (A) Fig. Q1 in the upper clamp (horizontal mounting position) with the outside of the board facing the jig.

Step 2 - Secure the template (B) on top of the pin board. Ensure the flatness by holding one hand on the template and using the other to tighten the template knobs.

Step 3 - Move the left offset guide all the way to the left. (Use the black offset guides for the standard cut, and the silver for the miniature cut).

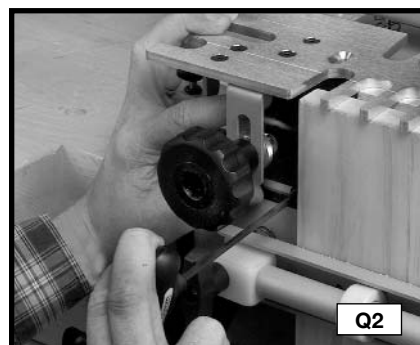
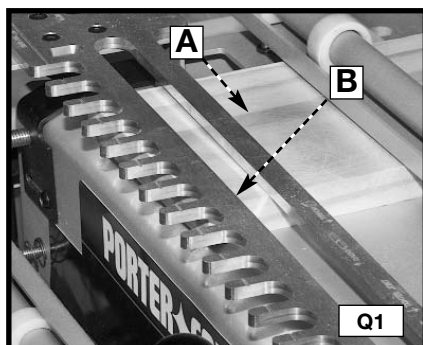

Step 4 - Clamp the tailboard (drawer side) in lower clamp (vertical position) on the left side of the base with the outside of the board facing the jig (A) Fig. Q3.

Step 5 - Center the board between the farthest finger on the left and the nearest finger on the right of the board.

Step 6 - Move the left offset guide (A) Fig. Q4 flush against the vertical board (B) and secure it.

Step 7 - Reposition the pin board (B) Fig. Q5 so that it is flush against the offset guide (A) and the back edge of the vertical board (C).

Step 8 - Align the template lines with the intersection of the pin board (A) Fig. Q6 and tail board (B).

Step 9 - Set the router bit depth using the bit-depth guide (A) Fig. Q7.

Step 10 - Climb cut (from right to left) the outer edge of the vertical board (Fig. Q8) to reduce tearout.

Step 11 - Rout along the fingers of the template (Fig. Q9). Remove the boards from the jig and test for fit.

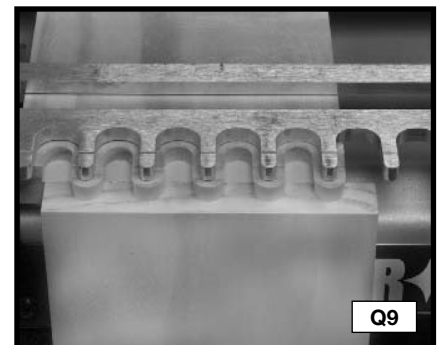
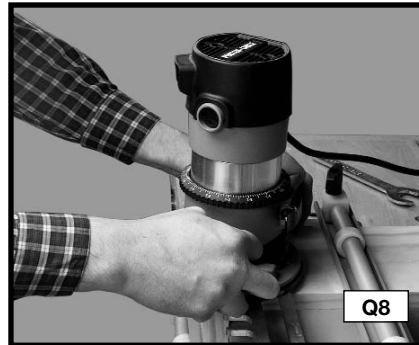
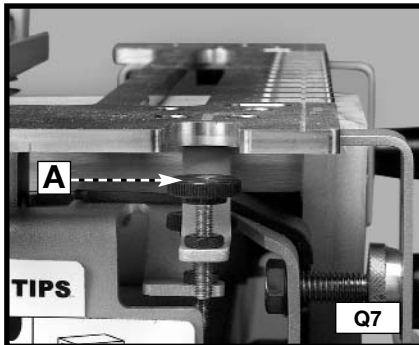
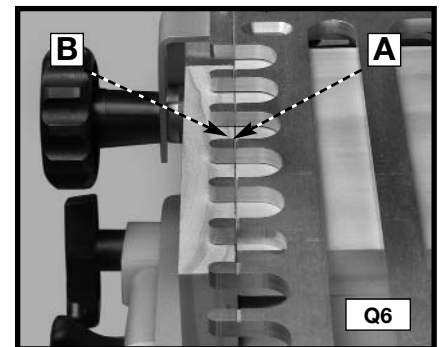
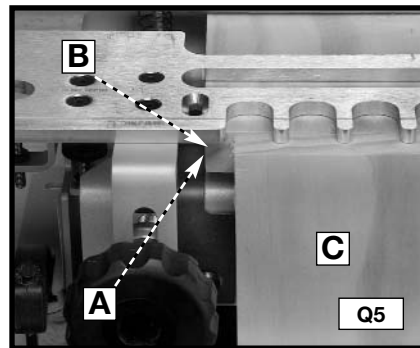
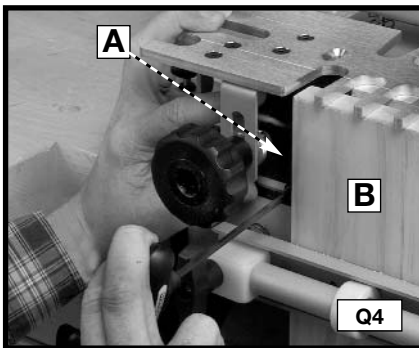
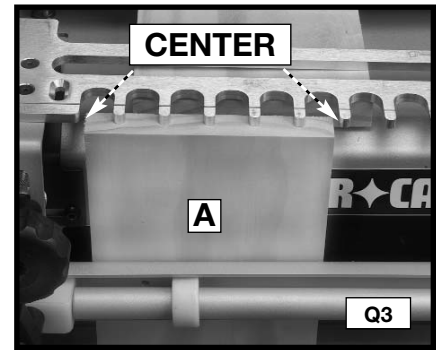

FITTING AND TROUBLESHOOTING

For joints that are too loose, adjust your router to make a deeper cut. (Measure the gap (A) Fig. Q10 in the test cut and adjust the router for that amount).

For joints that are too tight, adjust your router to make a more shallow cut.

Once you achieve the correct depth, secure the router bit depth guide in place with a 3/8" wrench.

If the drawer front overlaps the drawer side, reposition the template toward you (Fig. Q11).

If the drawer front is recessed from the edge of the drawer side (Fig. Q12), reposition the template away from you.

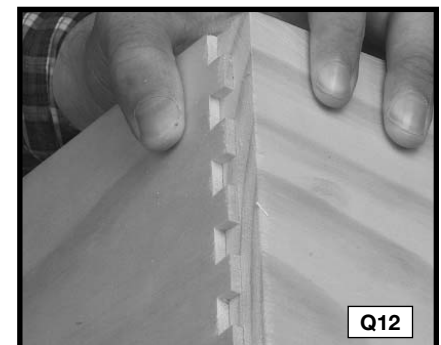
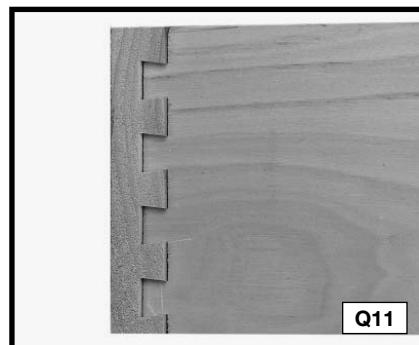
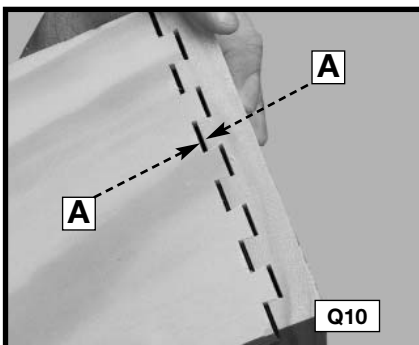

RABBETED HALF-BLIND DOVETAILS

To produce rabbeted half-blind dovetails (drawer front), cut the pins for a half-blind joint after the drawer front has been rabbeted. The depth of the rabbet must be deeper than the half-blind router bit depth guide.



- NOTE:** Cut the tails first.
For miniature half-blinds, use the 4215 accessory kit.
Use scrap wood until you are comfortable with the jig.
Mount the correct offset guides - black for the standard and silver for the miniature.

ITEMS NEEDED

- Half-blind Dovetail Template
- 17/32", 7° Dovetail Bit 43776PC
- 3/4" O.D. Template Guide, 42040
- Template Guide Lock Nut, 42239

ITEMS NEEDED FOR MINIATURE

- Miniature Dovetail Template
- 9/32", 7° Dovetail Bit 43777PC
- 3/8" O.D. Template Guide, 42037 (with dovetail bit)
- Template Guide Lock Nut, 42239
- Miniature Offset Guides (silver)

CUTTING THE TAILS

- Step 1** - Clamp a scrap board (A) Fig. R1 in the upper clamp (horizontal mounting position). Use scrap board that is thick enough to prevent the bit from contacting the base (1/2" will work). Secure the template (B) on top of the scrap board (Fig. R1). Ensure the flatness by holding one hand on the board and using the other to tighten the template knobs.
- Step 2** - Move the left offset guide all the way to the left (Fig. R2). (Use the black offset guides for the standard cut, and the silver for the miniature cut).
- Step 3** - Position and clamp the tail board in the lower clamp (vertical mounting position) with the outside surface against the jig base (Fig. R3).

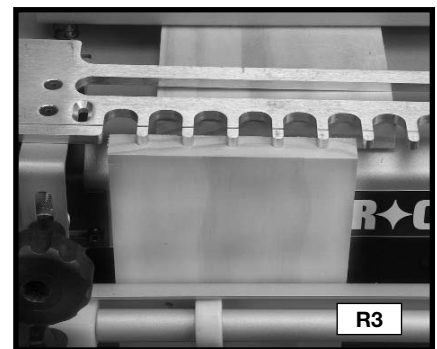
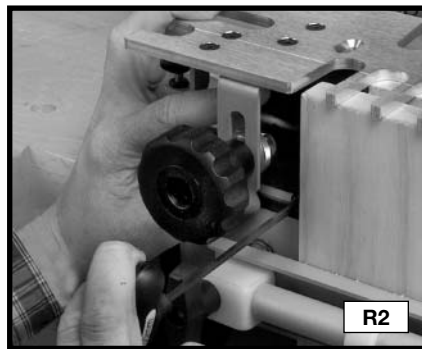
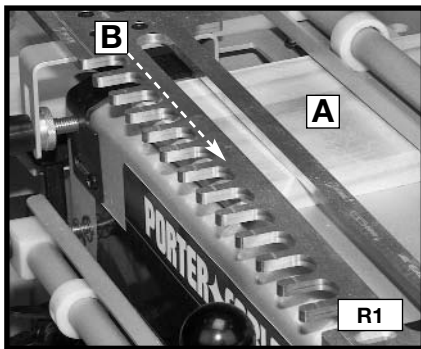

- Step 4** - Make a spacer equal to the rabbet's width. Put the spacer (A) Fig. R4 against the left edge of the tail board, move the left offset guide (B) flush against the spacer, and secure the offset guide.
- Step 5** - Reposition the scrap board (C) so that it is flush against the offset guide and the back edge of the vertical board.
- Step 6** - Align the "half-blind" template line (A) Fig. R5 with the line formed where the scrap board (B) and the vertical board (C) meet.

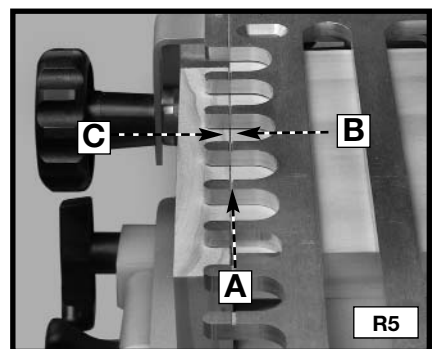
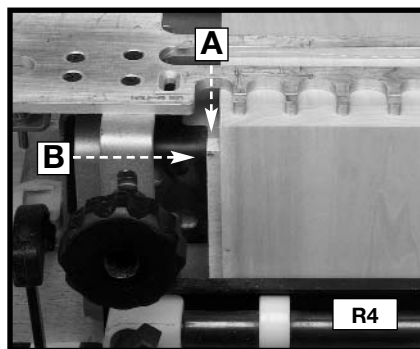

- Step 7** - Mount the dovetail bit and template guide to the router and set the router bit depth using the “half-blind” bit depth guide (Fig. R6).
- Step 8** - Make a climb-cut from right to left across the outer edge of the tail board to reduce tear-out (Fig. R7).
- Step 9** - Rout in and out of the fingers of the template from left to right (Fig. R8). Remove the boards.

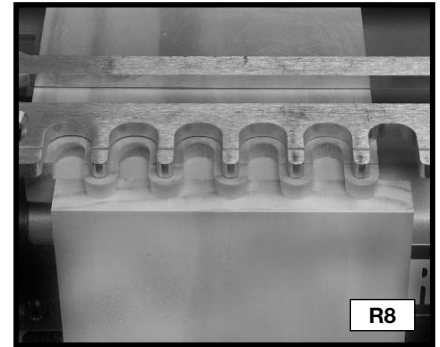
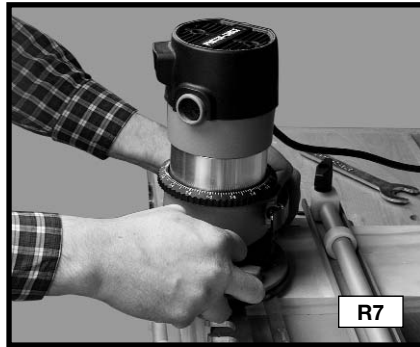
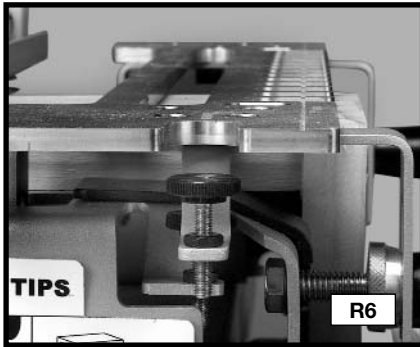

CUTTING THE PINS

- Step 1** - Clamp the pin board in the upper clamp (horizontal mounting position) with the outside surface against the jig's base.
- Step 2** - Secure the template on top of the pin board making sure that it is flat (Fig. R9).
- Step 3** - Reposition the pin board (A) Fig. R10 so that it is flush to the left offset guide (B) and the inside edge of the rabbet (A) Fig. R11 is aligned with the “half-blind” alignment line (B). Lower the router bit on the depth guide and lock the position on your router.
- Step 4** - Rout in and out of the fingers of the template from left to right.

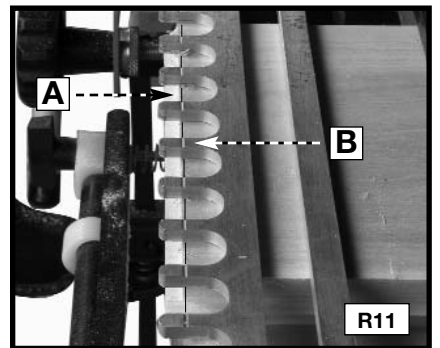
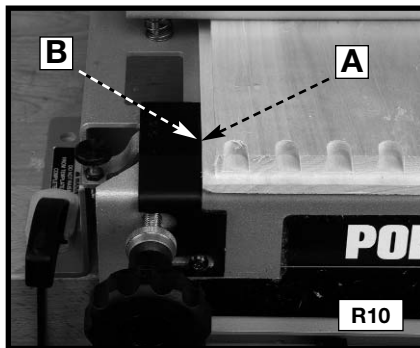
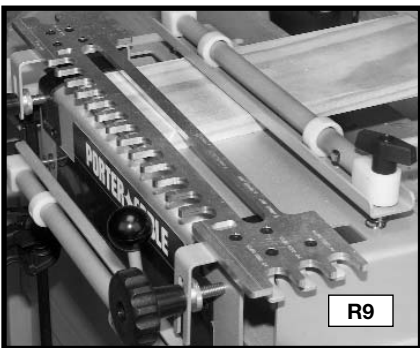

- Step 5** - Remove the boards from the jig and test for fit.

NOTE: Alternate method for aligning the pin board - Use a board with a rabbet the same width as the rabbet on the workpiece (R12).

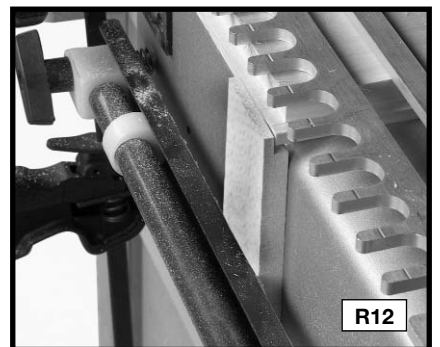

FITTING AND TROUBLESHOOTING

Fitting and troubleshooting methods for the lipped front half-blind dovetail are the same as for the regular half-blind dovetail.

BOX JOINTS

Box joints have straight protrusions that interlock and must be held together by glue. The large amount of gluing surface provides the strength necessary for large projects.



NOTE: If you are using the 4210 dovetail jig, you will need the 4213 accessory kit to make this joint. You will need the 4215 accessory kit for the miniature box joints.

Box joint fingers are spaced in 1" increments (1/2" for miniature).

ITEMS NEEDED

- Through Dovetail and Box Joint Template
- 1/2" diameter straight bit (not provided)
Length of the cutter must be at least the thickness of the workpiece.
- 3/4" O.D. Template Guide, 42040
- Template Guide Lock Nut, 42239

ITEMS NEEDED FOR MINIATURE

- Miniature Dovetail Template
- 1/4" diameter straight bit (not provided)
At least 1/2" long cutter
- 3/8" O.D. Template Guide, 42037
- Template Guide Lock Nut, 42239

CUTTING THE FIRST WORKPIECE

Step 1 - Clamp a scrap board (A) Fig. S1 in the upper clamp (horizontal mounting position) that is the same thickness as the second workpiece.

Step 2 - Use the T-handle wrench (A) Fig. S2 to loosen the screw on the left offset guide (B). Move the guide to the far left.

Step 3 - Mount the workpiece (A) Fig. S3 in the lower clamp (vertical mounting position) with the outside surface against the jig base.

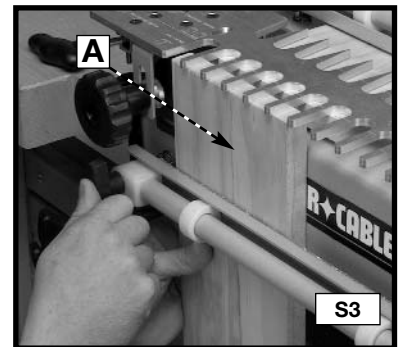
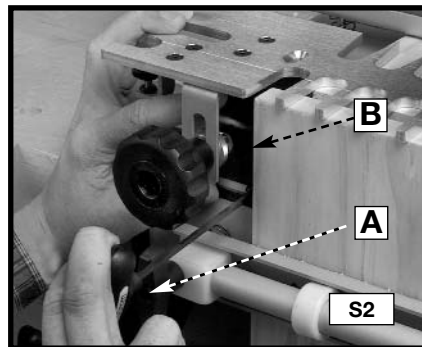
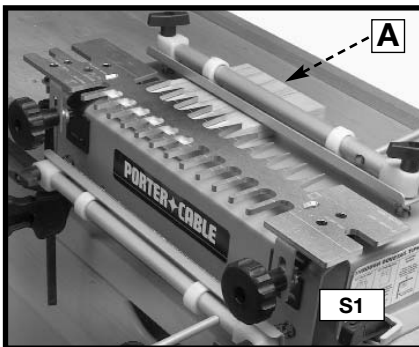

- Step 4** - Reposition the left offset guide (A) Fig. S4 flush against the workpiece (B).
- Step 5** - Align the template, using the “tails/Box” template line with the line formed where the scrap board and the workpiece meet.
- Step 6** - Mount the straight bit and template guide on the router and set the router bit depth using the “tails/box” bit depth guide.

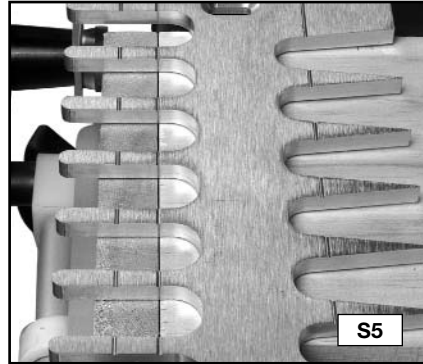
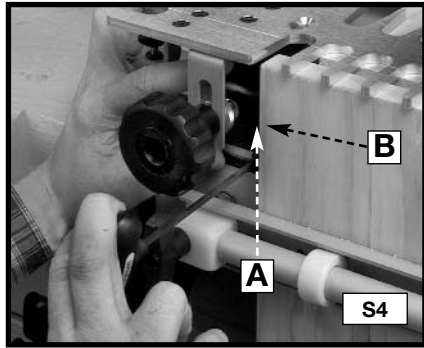

- Step 7** - Rout between the fingers of the jig with the templet guide against the left side of the fingers, both in and out. This light pressure toward the left will help to prevent loose joints.
- Step 8** - Remove the workpiece from the jig.



CUTTING THE SECOND WORKPIECE

NOTE: If the thickness is different between the first and second workpiece, replace the scrap piece in the upper clamp (horizontal Mounting position) with another that is the same thickness as the first workpiece.

- Step 1** - Use the T-handle wrench (A) Fig. S8 to loosen the screw on the right offset guide (B) Fig.S10. Move the guide to the far right.
- Step 2** - Clamp the first board in the lower clamp on the right side of the jig with the fingers protruding past the template (Fig. S9).Center the protrusions of the wood in between the fingers of the templet.
- Step 3** - Move the right offset guide flush against the workpiece and secure it with the T-handle wrench (Fig. S10).
- Step 4** - Remove the first workpiece.

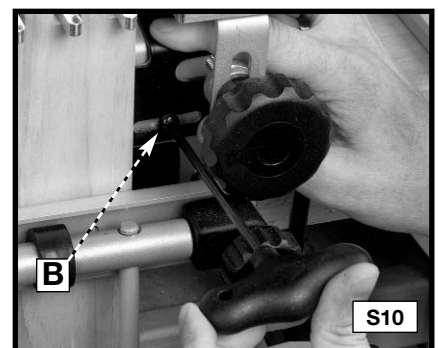
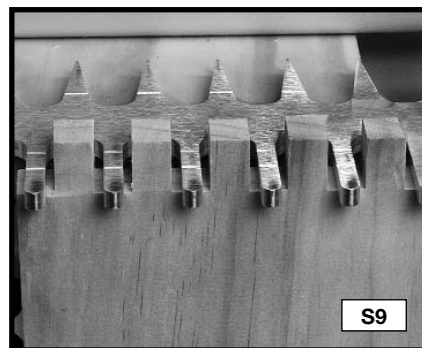
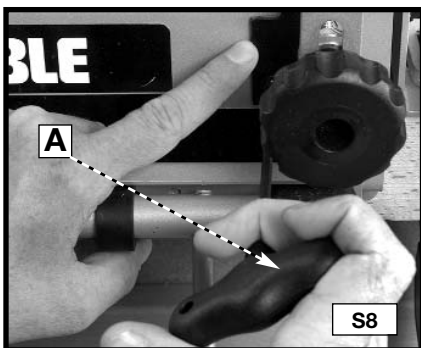

- Step 5** - Clamp the second workpiece (A) Fig. S11 in the lower clamp (vertical mounting position) on the **right** side of the jig flush against both the template (B) and against the right offset guide (C) with the outside surface facing away from the jig.
- Step 6** - If the first and second workpieces are of different thicknesses, reset the router bit depth using the "tails/box" bit depth guide.
- Step 7** - Rout between the fingers of the jig with the templet guide against the left side of the fingers, both in and out. This light pressure toward the left will help to prevent loose joints (Fig. S12).
- Step 8** - Remove the second workpiece and assemble the joint (Fig. S13)

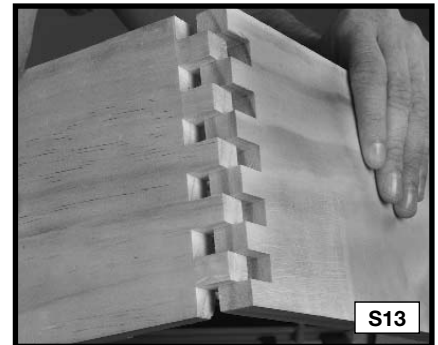
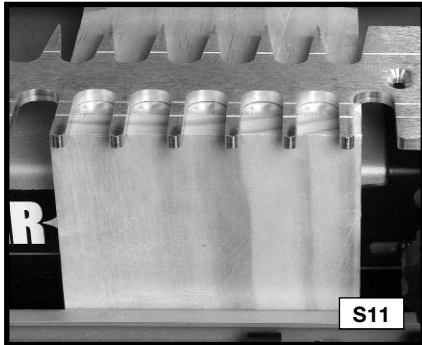

NOTE: The fit (tightness) of the box joint cannot be adjusted.

DOVETAIL DADOS (SLIDING DOVETAILS)

Dovetail dados (sliding dovetails) are used primarily in the construction of cabinets, entertainment centers and shelving. The 4200 series jigs have three preset depths for dados (1/4", 3/8" and 1/2"), but you can manually set your router bit depth to any setting.

NOTE: Be certain that the router bit will not cut into the base or offset guides during this cut. Everything is provided for this cut in both the 4210 and 4212 jigs.

ITEMS NEEDED

- Dado Template
- 17/32", 7° Dovetail Bit 43776PC
- 3/4" O.D. Template Guide, 42040
- Template Guide Lock Nut, 42239



CUTTING THE DADO BOARD

- Step 1** - Mark the centerline (A) Fig. T1 of the dado location on the workpiece.
- Step 2** - Make two marks 3/8" from the centerline of the dado (B) Fig. T1.
- Step 3** - Insert the workpiece (A) Fig. T2 in the upper clamp (horizontal clamping position) and place the dado template (B) on the jig with the dado side facing you. Adjust the template so that the lines that you drew in STEP 2 (C) are aligned exactly with the edges of the slot.

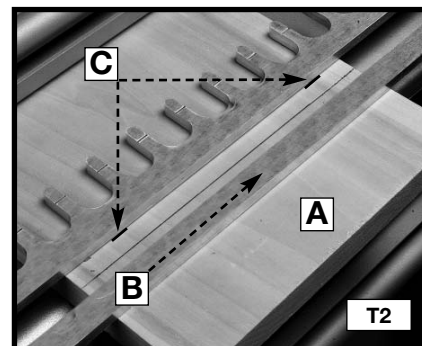
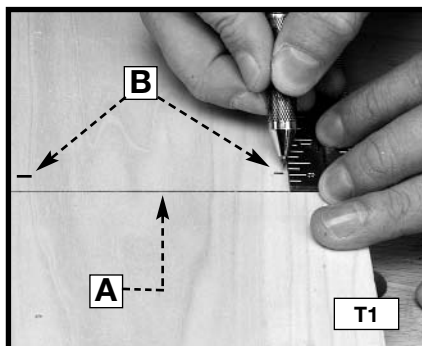

- Step 4** - Set your router bit depth by using either of the three choices (A, B, or C) Fig. T3 on the left side of the template, or by manually setting the router to another depth.
- Step 5** - Slowly rout along the slot from left to right (Fig. T4). (Some deep dados may require cutting the bulk of the material with a straight bit).
- Step 6** - Remove the workpiece.

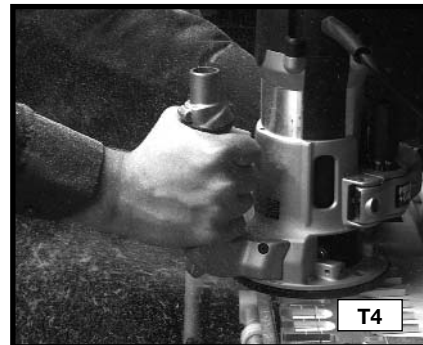
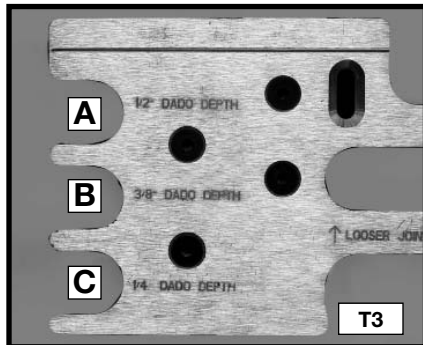

CUTTING THE TENON BOARD

- Step 1** - Mount a scrap board (A) Fig. T6 in the upper clamp (horizontal mounting position)
- Step 2** - Mount the tenon board (B) Fig. T6 in the lower clamp (vertical mounting position).
- Step 3** - Make a climb cut (from right to left) on the front edge of the template.
- Step 4** - Make another cut from left to right along the front edge of the template.
- Step 5** - Remove the tenon board. Keep the same end up and turn the board so that the cut side of the board faces the base. Repeat **STEPS 3** and **4**.
- Step 6** - Remove the tenon board and fit the joint.

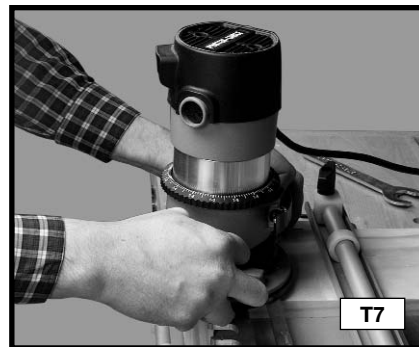
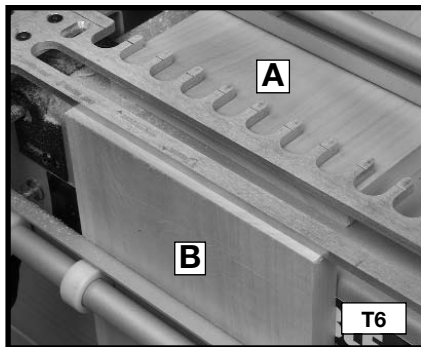

FITTING AND TROUBLESHOOTING

- For joints that are too loose, move the template toward you and recut the tenon board.
- For joints that are too tight, move the template away from you and recut the tenon board.

MAINTENANCE

KEEP TOOL CLEAN

Periodically blow out all air passages with dry compressed air. Clean all plastic parts with a soft damp cloth. NEVER use solvents to clean plastic parts. They could possibly dissolve or otherwise damage the material.

⚠ CAUTION WEAR ANSI Z87.1 SAFETY GLASSES WHILE USING COMPRESSED AIR.

SERVICE AND REPAIRS

All quality tools will eventually require servicing or replacement of parts due to wear from normal use. These operations, including brush inspection and replacement, should ONLY be performed by either an AUTHORIZED PORTER-CABLE SERVICE STATION or a PORTER-CABLE-DELTA FACTORY SERVICE CENTER. All repairs made by these agencies are fully guaranteed against defective material and workmanship. We cannot guarantee repairs made or attempted by anyone other than these agencies.

Should you have any questions about your tool, feel free to write us at any time. In any communications, please give all information shown on the nameplate of your tool (model number, type, serial number, etc.).

ACCESSORIES

A complete line of accessories is available from your Porter-Cable•Delta Supplier, Porter-Cable•Delta Factory Service Centers, and Porter-Cable Authorized Service Stations. Please visit our Web Site www.porter-cable.com for a catalog or for the name of your nearest supplier.

⚠ WARNING Since accessories other than those offered by Porter-Cable•Delta have not been tested with this product, use of such accessories could be hazardous. For safest operation, only Porter-Cable•Delta recommended accessories should be used with this product.

WARRANTY

PORTER-CABLE LIMITED ONE YEAR WARRANTY

Porter-Cable warrants its Professional Power Tools for a period of one year from the date of original purchase. We will repair or replace at our option, any part or parts of the product and accessories covered under this warranty which, after examination, proves to be defective in workmanship or material during the warranty period. For repair or replacement return the complete tool or accessory, transportation prepaid, to your nearest Porter-Cable Service Center or Authorized Service Station. Proof of purchase may be required. This warranty does not apply to repair or replacement required due to misuse, abuse, normal wear and tear or repairs attempted or made by other than our Service Centers or Authorized Service Stations.

ANY IMPLIED WARRANTY, INCLUDING THE IMPLIED WARRANTIES OF MERCHANTABILITY AND FITNESS FOR A PARTICULAR PURPOSE, WILL LAST ONLY FOR ONE (1) YEAR FROM THE DATE OF PURCHASE.

To obtain information on warranty performance please write to: PORTER-CABLE CORPORATION, 4825 Highway 45 North, Jackson, Tennessee 38305; Attention: Product Service. THE FOREGOING OBLIGATION IS PORTER-CABLE'S SOLE LIABILITY UNDER THIS OR ANY IMPLIED WARRANTY AND UNDER NO CIRCUMSTANCES SHALL PORTER-CABLE BE LIABLE FOR ANY INCIDENTAL OR CONSEQUENTIAL DAMAGES. Some states do not allow limitations on how long an implied warranty lasts or the exclusion or limitation of incidental or consequential damages, so the above limitation or exclusion may not apply to you.

This warranty gives you specific legal rights and you may also have other legal rights which vary from state to state.

PORTER-CABLE • DELTA SERVICE CENTERS (CENTROS DE SERVICIO DE PORTER-CABLE • DELTA)

Parts and Repair Service for Porter-Cable • Delta Machinery are Available at These Locations
(Obtenga Refaccion de Partes o Servicio para su Herramienta en los Siguientes Centros de Porter-Cable • Delta)

ARIZONA

Phoenix 85013-2906
4501 N. 7th Ave.
Phone: (602) 279-6414
Fax: (602) 279-5470

CALIFORNIA

Ontario 91761 (Los Angeles)
3949A East Guasti Road
Phone: (909) 390-5555
Fax: (909) 390-5554

San Diego 92111
7290 Clairemont Mesa Blvd.
Phone: (858) 279-2011
Fax: (858) 279-0362

San Leandro 94577 (Oakland)
3039 Teagarden Street
Phone: (510) 357-9762
Fax: (510) 357-7939

COLORADO

Denver 80223
700 West Mississippi Ave.
Phone: (303) 922-8325
Fax: (303) 922-0245

FLORIDA

Davie 33314 (Miami)
4343 South State Rd. 7 (441)
Unit #107
Phone: (954) 321-6635
Fax: (954) 321-6638

Tampa 33634
4909 West Waters Ave.
Phone: (813) 884-0434
Fax: (813) 888-5997

GEORGIA

Forest Park 30297 (Atlanta)
5442 Frontage Road,
Suite 112
Phone: (404) 608-0006
Fax: (404) 608-1123

ILLINOIS

Addison 60101 (Chicago)
400 South Rohlwing Rd.
Phone: (630) 424-8805
Fax: (630) 424-8895

KANSAS

Overland Park 66214
9201 Quivira Road
Phone: (913) 495-4330
Fax: (913) 495-4378

MARYLAND

Elkridge 21075 (Baltimore)
7397-102 Washington Blvd.
Phone: (410) 799-9394
Fax: (410) 799-9398

MASSACHUSETTS

Franklin 02038 (Boston)
Franklin Industrial Park
101E Constitution Blvd.
Phone: (508) 520-8802
Fax: (508) 528-8089

MICHIGAN

Madison Heights 48071 (Detroit)
30475 Stephenson Highway
Phone: (248) 597-5000
Fax: (248) 597-5004

MINNESOTA

Eden Prairie 55344
9709 Valley View Road
Phone: (952) 884-9191
Fax: (952) 884-3750

MISSOURI

St. Louis 63146
11477 Page Service Drive
Phone: (314) 997-9100
Fax: (314) 997-9183

NEW YORK

Flushing 11365-1595 (N.Y.C.)
175-25 Horace Harding Expwy.
Phone: (718) 225-2040
Fax: (718) 423-9619

NORTH CAROLINA

Charlotte 28270
9129 Monroe Road, Suite 115
Phone: (704) 841-1176
Fax: (704) 708-4625

OHIO

Columbus 43229
1948 Schrock Road
Phone: (614) 895-3112
Fax: (614) 895-3187

Parma Heights OH 44130
6485 Pearl Road
Phone: (440) 842-9100
Fax: (440) 884-3430

OREGON

Portland 97230
14811 North East Airport Way
Phone: (503) 255-6556
Fax: (503) 255-6543

PENNSYLVANIA

Willow Grove 19090
(Philadelphia)
520 North York Road
Phone: (215) 658-1430
Fax: (215) 658-1433

TEXAS

Carrollton 75006 (Dallas)
1300 Interstate 35 N, Suite 112
Phone: (972) 446-2996
Fax: (972) 446-8157

Houston 77022-2122

536 East Tidwell Rd.
Phone: (713) 692-7111
Fax: (713) 692-1107

WASHINGTON

Auburn 98001 (Seattle)
3320 West Valley HWY, North
Building D, Suite 111
Phone: (253) 333-8353
Fax: (253) 333-9613

Authorized Service Stations are located in many large cities. Telephone **800-438-2486** or **731-541-6042** for assistance locating one. Parts and accessories for Porter-Cable•Delta products should be obtained by contacting any Porter-Cable•Delta Distributor, Authorized Service Center, or Porter-Cable•Delta Factory Service Center. If you do not have access to any of these, call **800-223-7278** and you will be directed to the nearest Porter-Cable•Delta Factory Service Center. Las Estaciones de Servicio Autorizadas están ubicadas en muchas grandes ciudades. Llame al **800-438-2486** ó al **731-541-6042** para obtener asistencia a fin de localizar una. Las piezas y los accesorios para los productos Porter-Cable•Delta deben obtenerse poniéndose en contacto con cualquier distribuidor Porter-Cable•Delta, Centro de Servicio Autorizado o Centro de Servicio de Fábrica Porter-Cable•Delta. Si no tiene acceso a ninguna de estas opciones, llame al **800-223-7278** y le dirigirán al Centro de Servicio de Fábrica Porter-Cable•Delta más cercano.

CANADIAN PORTER-CABLE • DELTA SERVICE CENTERS

ALBERTA

Bay 6, 2520-23rd St. N.E.
Calgary, Alberta
T2E 8L2
Phone: (403) 735-6166
Fax: (403) 735-6144

BRITISH COLUMBIA

8520 Baxter Place
Burnaby, B.C.
V5A 4T8
Phone: (604) 420-0102
Fax: (604) 420-3522

MANITOBA

1699 Dublin Avenue
Winnipeg, Manitoba
R3H 0H2
Phone: (204) 633-9259
Fax: (204) 632-1976

ONTARIO

505 Southgate Drive
Guelph, Ontario
N1H 6M7
Phone: (519) 767-4132
Fax: (519) 767-4131

QUÉBEC

1515 ave.
St-Jean Baptiste, Suite 160
Québec, Québec
G2E 5E2
Phone: (418) 877-7112
Fax: (418) 877-7123

1447, Begin
St-Laurent, (Montréal),
Québec
H4R 1V8
Phone: (514) 336-8772
Fax: (514) 336-3505

The following are trademarks of PORTER-CABLE • DELTA (Las siguientes son marcas registradas de PORTER-CABLE • DELTA S.A.) (Les marques suivantes sont des marques de fabricant de la PORTER-CABLE • DELTA): Auto-Set®, BAMMER®, B.O.S.S.®, Builder's Saw®, Contractor's Saw®, Contractor's Saw II™, Delta®, DELTACRAFT®, DELTAGRAM™, Delta Series 2000™, DURATRONIC™, Emc²™, FLEX®, Flying Chips™, FRAME SAW®, Grip Vac™, Homecraft®, INNOVATION THAT WORKS®, Jet-Lock®, JETSTREAM®, 'kickstand®, LASERLOC®, MICRO-SET®, Micro-Set®, MIDI LATH®, MORTEN™, NETWORK™, OMNIJIG®, POCKET CUTTER®, PORTA-BAND®, PORTA-PLANE®, PORTER-CABLE®&(design), PORTER-CABLE®PROFESSIONAL POWER TOOLS, PORTER-CABLE REDEFINING PERFORMANCE™, Posi-Matic®, Q-3®&(design), QUICKSAND®&(design), QUICKSET™, QUICKSET II®, QUICKSET PLUS™, RIPTIDE™&(design), SAFE GUARD II®, SAFE-LOC®, Sanding Center®, SANDTRAP®&(design), SAW BOSS®, Sawbuck™, Sidekick®, SPEED-BLOC®, SPEEDMATIC®, SPEEDTRONIC®, STAIR EASE®, The American Woodshop®&(design), The Lumber Company®&(design), THE PROFESSIONAL EDGE®, THE PROFESSIONAL SELECT®, THIN-LINE™, TIGER®, TIGER CUB®, TIGER SAW®, TORQBUSTER®, TORQ-BUSTER®, TRU-MATCH™, TWIN-LITE®, UNIGUARD®, Unifence®, UNIFEEDER™, Unihead®, Uniplane™, Unirip®, Unisaw®, Univise®, Versa-Feeder®, VERSA-PLANE®, WHISPER SERIES®, WOODWORKER'S CHOICE™.

Trademarks noted with ™ and ® are registered in the United States Patent and Trademark Office and may also be registered in other countries. Las Marcas Registradas con el signo de ™ y ® son registradas por la Oficina de Registros y Patentes de los Estados Unidos y también pueden estar registradas en otros países.

Free Manuals Download Website

<http://myh66.com>

<http://usermanuals.us>

<http://www.somanuals.com>

<http://www.4manuals.cc>

<http://www.manual-lib.com>

<http://www.404manual.com>

<http://www.luxmanual.com>

<http://aubethermostatmanual.com>

Golf course search by state

<http://golfingnear.com>

Email search by domain

<http://emailbydomain.com>

Auto manuals search

<http://auto.somanuals.com>

TV manuals search

<http://tv.somanuals.com>