

The Advanced IP-PBX Communication Solution

PHILIPS

SOPHO IPC 100

**System and Display phone
User Guide**

Before using Your Telephone...

Thank you for purchasing the SOPHO IPC 100 system.

The telephone described in this manual should only be connected to a SOPHO IPC 100 system by means of the installation cables that come with the equipment.

Due to the flexibility built into the system, your **Dialling Codes and Feature Capacities** may differ from those in this guide. Check with your Supplier / System Administrator and make a note of any differences.

Using Your Multiline Telephone...

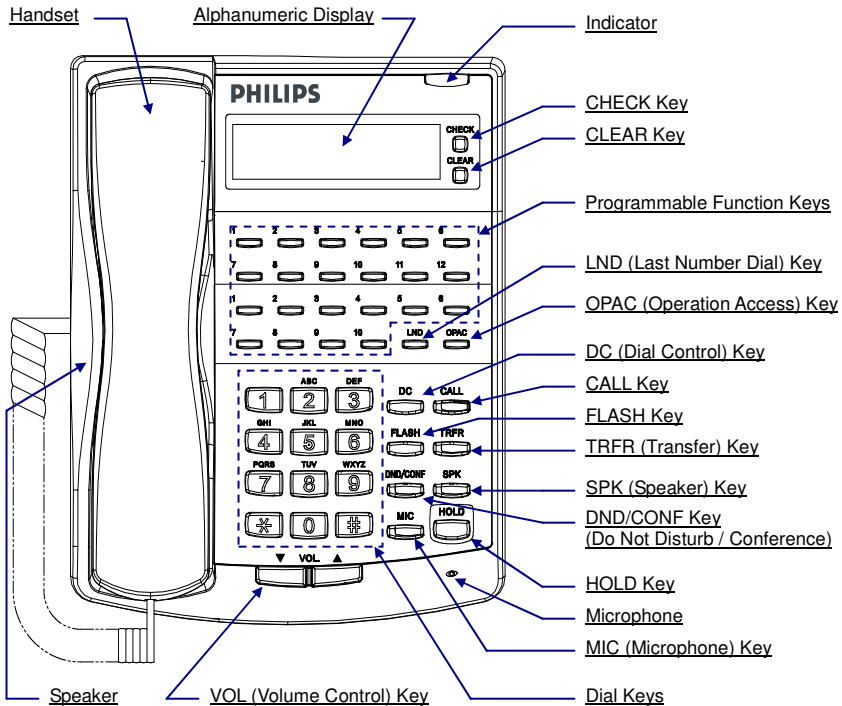

| Functions | 22 button display phone | 22 button system phone |
|----------------------|-------------------------|------------------------|
| Programmable Keys | 12 | 12 |
| Additional Prg. Keys | 10 | 10 |
| Display | Yes | No |
| CHECK/CLEAR Keys | Yes | No |
| Handsfree | Yes | No (Talkback) |
| Accept DLS Console | Yes | No |
| Wall Mount Kit | Yes (Built-in) | Yes (Built-in) |

Handsfree Options

- Handsfree lets you place and answer calls by pressing "SPK" instead of using the handset.
- With Automatic Handsfree, you can press the CALL Key without lifting the handset. Normally, you have Automatic Handsfree.
- Use Handsfree Answerback to answer a voice-announced Intercom call by speaking toward your phone without lifting the handset or pressing a key.

For Your Convenience

Programming a Function Key

Programmable Function Keys can be assigned as Appearance Keys (e.g. Trunks) or General Keys (e.g. DSS/One-Touch). Press the Function Key to activate the assigned function without dialling the Service Code.

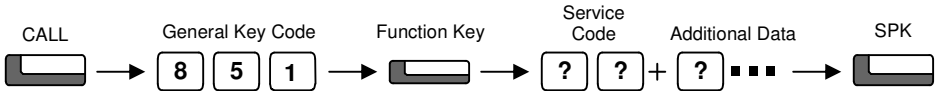

- ◆ An existing Appearance Key cannot be overwritten without the Appearance Key first being erased.
- ◆ Programmable Function Keys (General Key Code) can be erased by entering Service Code 00.

Common Service Codes:

| | | | |
|----|------------------------------------|----|-------------------------------|
| 01 | DSS/One-Touch Key | 10 | Call Forward – Immediate |
| 03 | DND Key | 11 | Call Forward – Busy |
| 04 | Background Music (ON/OFF) | 12 | |
| | Headset Key | 13 | Call Forward – Busy/No Answer |
| 08 | Incoming Caller ID List | 14 | Call Forward – Dual Ring |
| 19 | External Zone Paging | 15 | Call Forward – Follow Me |
| 20 | External All Call Paging | 16 | Call Forward – Select Option |
| 21 | Internal Zone Paging | 17 | Call Forward – Device |
| 22 | Internal All Call Paging | 29 | Repeat Redial |
| 27 | Abbreviated Dial – Common/Personal | 30 | Saved Number Redial |
| 28 | Abbreviated Dial – Group | 31 | Memo Dial |
| 85 | Directory Dialling | | |

Programming a DSS/One-Touch Key

Programmable Function Keys can be assigned as DSS (Direct Station Selection) or One-Touch Keys. You can place an Outside or Intercom call by pressing this key without dialling the number.

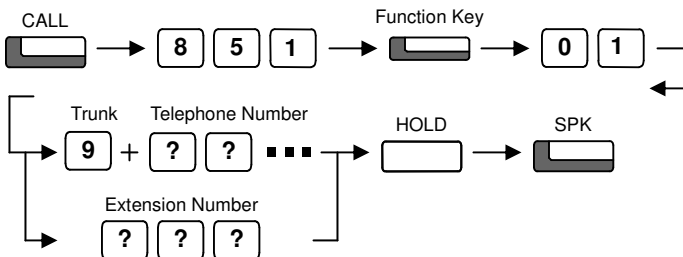

- ◆ Function Keys with one or two colour LEDs programmed as DSS keys will provide extension status indication, Idle=Off, Busy=lit. This is known as Busy Lamp Field (BLF) indication.
- ◆ When storing an outside telephone number, the Trunk Access Code (normally 9) must be added to the start of the number. Up to 36 digits can be stored.
- ◆ To program another key, press the next Programmable Function Key instead of the SPK Key to finish.

For Your Convenience

Programming Abbreviated Dialling Bins

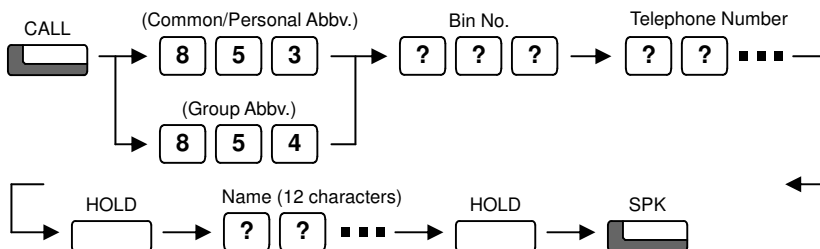

- ◆ Common/Personal Abbreviated Dialling Bins are numbered as follows (by default):
 2-digit dialling: Common = 00-79, Personal = 80-99, or
 3-digit dialling: Common = 000-899, Personal = 990-919.
- ◆ System programming is required to allow Group Abbreviated Dialling. Ask your PBC Authorised Supplier.
- ◆ Up to 36 digits dialling can be stored in each abbreviated dialling bin.
- ◆ To clear an abbreviated dialling bin (number & name), press the "CLEAR" key after dialling the Bin No.
- ◆ Applicable to IPC 100 display Phones only.

Entering a Name into an Abbreviated Dialling Bin

When entering a name, use the Dial Pad Keys on your telephone to enter letters as shown below. For example, press the "2" key once for "A", twice for "B"; etc...

| | Number of Key Presses | | | | | | | | | | | | |
|----------|-----------------------|---|---|---|----|---|---|---|---|----|----|----|----|
| | 1 | 2 | 3 | 4 | 5 | 6 | 7 | 8 | 9 | 10 | 11 | 12 | 13 |
| 1 | 1 | @ | [| ¥ |] | ^ | _ | ' | { | } | → | ← | |
| 2 | A | B | C | a | b | c | 2 | | | | | | |
| 3 | D | E | F | d | e | f | 3 | | | | | | |
| 4 | G | H | I | g | h | i | 4 | | | | | | |
| 5 | J | K | L | j | k | l | 5 | | | | | | |
| 6 | M | N | O | m | n | o | 6 | | | | | | |
| 7 | P | Q | R | S | p | q | r | s | 7 | | | | |
| 8 | T | U | V | t | u | v | 8 | | | | | | |
| 9 | W | X | Y | Z | w | x | y | z | 9 | | | | |
| 0 | 0 | ! | " | # | \$ | % | & | ' | (|) | | | |
| * | * | + | , | - | . | / | : | ; | < | = | > | ? | |

Accepts a character and move the cursor one place to the right. Press twice to insert a "space".

DND/CONF Clear the character entry to the left, one character at a time (Backspace Key).

Placing Calls

Placing an Outside Call <Quick Access>

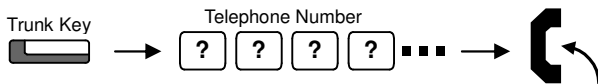

- ◆ Listen for Dial Tone before dialling a Telephone Number.
- ◆ You can have function keys for Trunks or Trunk Groups. Ask your PBC Authorised Supplier.

Placing an Outside Call <Access Code>

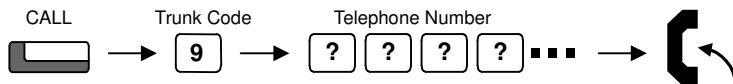

- ◆ Listen for Dial Tone before dialling the Telephone Number.

Placing an Intercom Call <Dial Access>

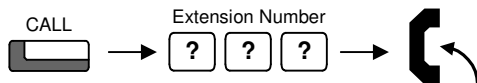

- ◆ Pressing CALL key after dialling an extension number is also possible.
- ◆ Your call will ring or voice-announce. If you hear ringing, wait for an answer. If you hear a beep, begin speaking. Dialling "1" changes voice/ring mode (where the destination is an IPC 100 Telephone).

Placing Calls Quickly

Using Abbreviated Dialling <Outside Calls>

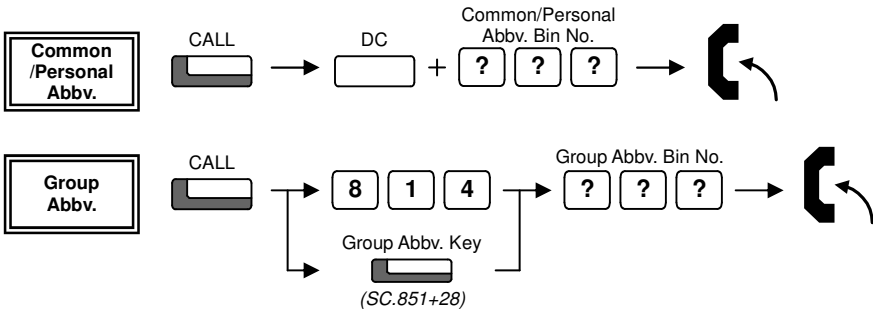

- ◆ Common/Personal Abbreviated Dialling Bins are numbered as follows (by default):
2-digit dialling: Common = 00-79, Personal = 80-99, or
3-digit dialling: Common = 000-899, Personal = 990-919.
- ◆ System programming is required to provide Group Abbreviated Dialling. Ask your PBC Authorised Supplier for details.

Using One-Touch Keys <Outside/Intercom Calls>

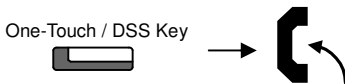

- ◆ The Telephone / Extension Number shall be pre-registered to a One-Touch / DSS Key (refer to Page 2).
- ◆ Trunk Access Code (Dial "0") should be added as the first digit of the Telephone Number.

Last Number Redial < Outside/Intercom Calls>

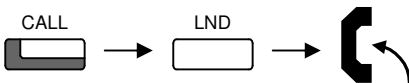

Redial List

The system retains the last 10 numbers dialled which can be viewed and dialled.
(IPC 100 Display Phones Only)

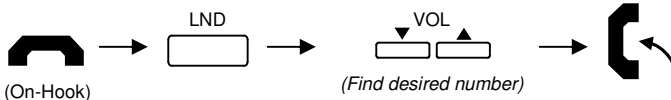

- ◆ Intercom numbers can also be stored under Last Number Redial. Ask your PBC Authorised Supplier for details.

If your call doesn't go through...

Setting Camp On / Callback / Trunk Queuing

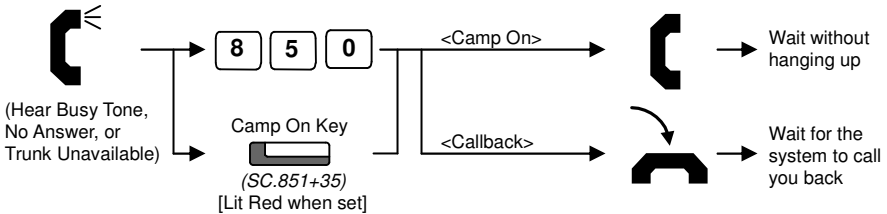

- ◆ **<Camp On>** For Intercom Call, when you hear ringing, wait for the called party to answer.
For Trunk Queuing, when you hear Dial Tone, begin dialling the telephone number.
- ◆ **<Callback>** For Intercom Call, when your phone starts the ringing, lift handset and wait for the called party to answer.
For Trunk Queuing, when your phone starts the ringing, lift handset, hear Dial Tone and begin dialling the telephone number.

Cancelling Camp On / Callback / Trunk Queuing

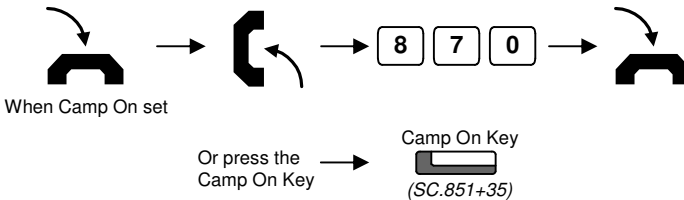

Set / Answer a Message Waiting

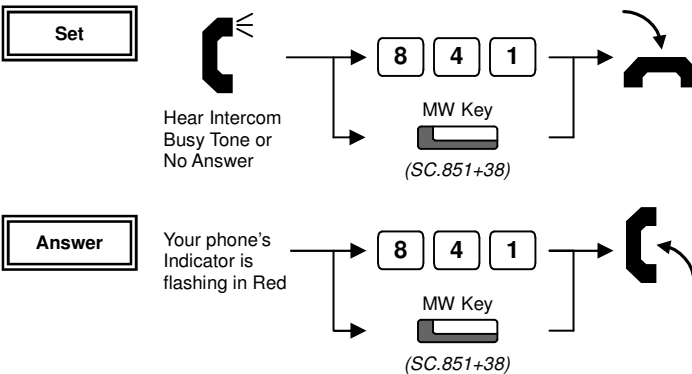

- ◆ When you set a MW, the called party's MW Indicator starts to flash, and your MW Indicator is lit Red.
- ◆ When you answer a MW, the MW Indicator will automatically go off when the called party answers.

If your call doesn't go through...

Checking & Answering a Message Waiting Indication

You can check who left a message waiting indication for you, and then answer.

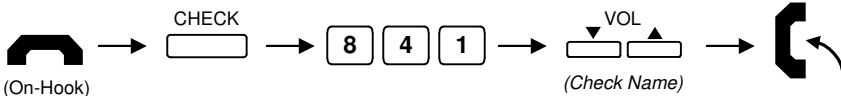

◆ Applicable to IPC 100 Display Telephones only.

Cancelling a Message Waiting Indication (at originating extension)

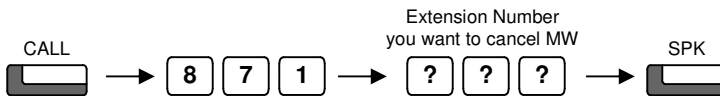

Clearing All Message Waiting Indications (at any extension)

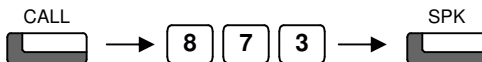

◆ Clears all messages you have left for other extensions and messages other extension have left for you.

Repeat Dialling <Outside Call>

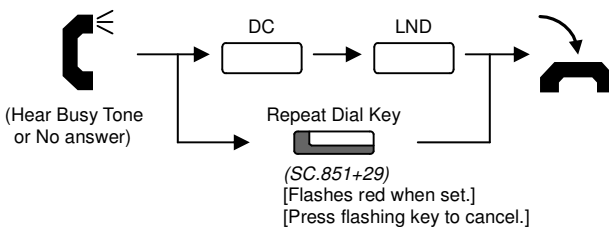

- ◆ The system periodically redials the call. Repeat duration is programmable. Ask your PBC Authorised Supplier for details.
- ◆ You should lift the handset when the called party answered.
- ◆ You can cancel this function by pressing "DC" and "LND" during idle condition.
- ◆ Does not reserve line. Will select other available line when original line is in use.

Answering Calls

Answering an Outside Call

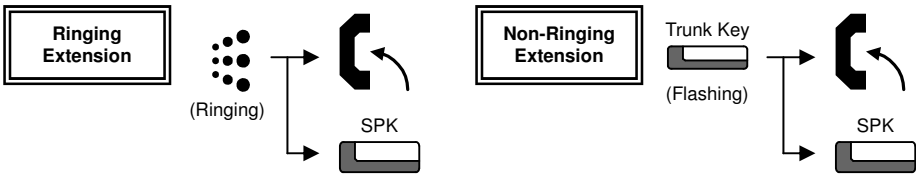

- ◆ Confirm status of the MIC Key if you want to answer Handsfree [MIC On = Light On, MIC Off = Light Off]. (IPC 100 Display Phones Only)

Answering an Intercom Call

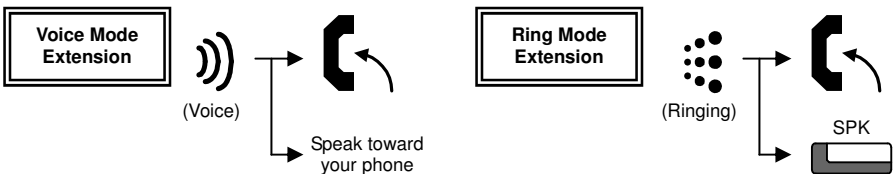

- ◆ Intercom Call Mode can be set at your phone as follows: "Ring" = CALL + 823, "Voice" = CALL + 821.
- ◆ Confirm status of the MIC Key if you want to answer Handsfree [MIC On = Light On, MIC Off = Light Off]

Picking up another Extension's Call

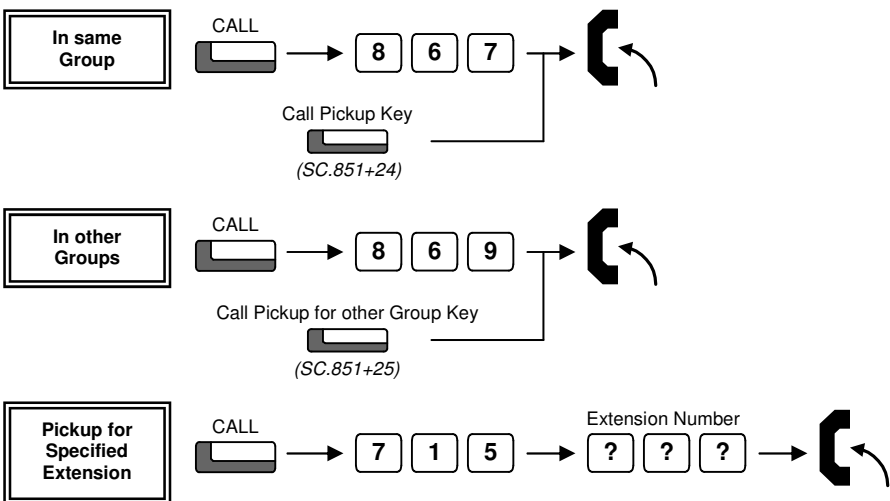

- ◆ System programming is required to allow Group Call Pickup. Ask your PBC Authorised Supplier for details.

Hold / Transferring Calls

Placing a Call on Hold / Retrieving a Held Call

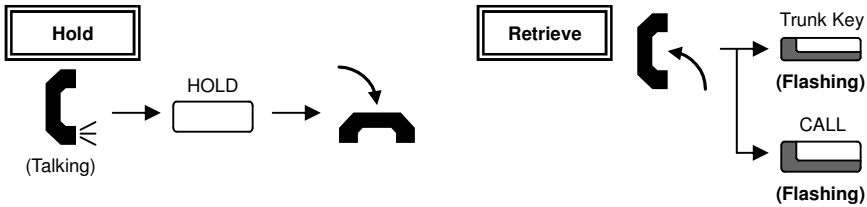

- ◆ When an Intercom call is placed on hold, the call is held as "Exclusive Hold" on your phone.
- ◆ While your outside call is on System Hold, other extension users can take the call off Hold.

Placing a Call on Exclusive Hold

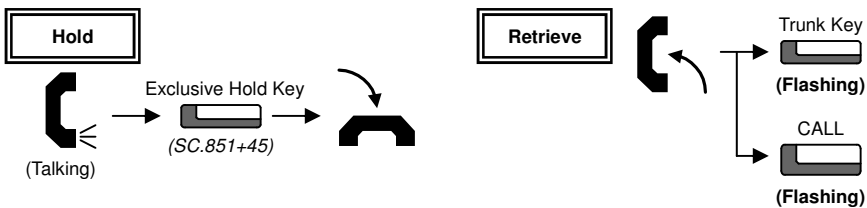

- ◆ System programming is required to use Exclusive Hold. Ask your PBC Authorised Supplier for details.
- ◆ While your outside call is on Exclusive Hold, other extension users can not take the call off Hold.

Retrieving a Held Outside Call (if your extension doesn't have trunk keys)

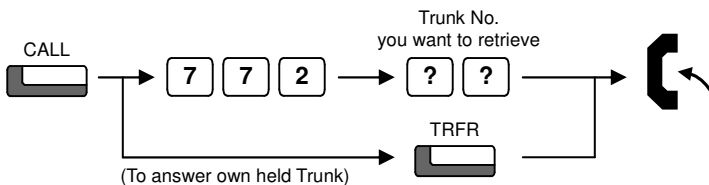

Transferring a Call to another Extension

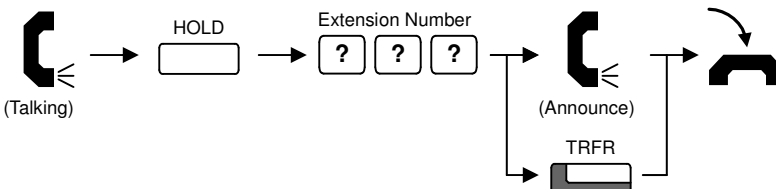

- ◆ If your phone has a DSS or One-Touch key for the extension user who is to receive the call, just press it instead of "HOLD + Extension Number" in the operation above.

For more convenient use...

Do Not Disturb (DND)

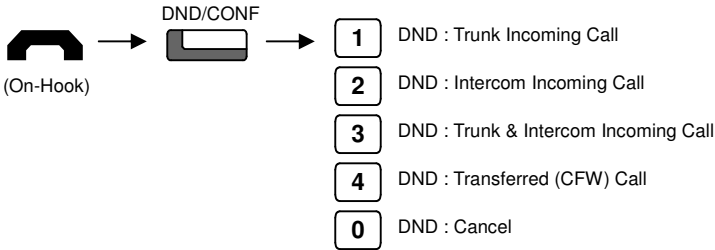

◆ When you set DND, the DND/CONF Key's lamp is lit and the Internal Dial Tone pattern changes.

Call Forward / Follow Me

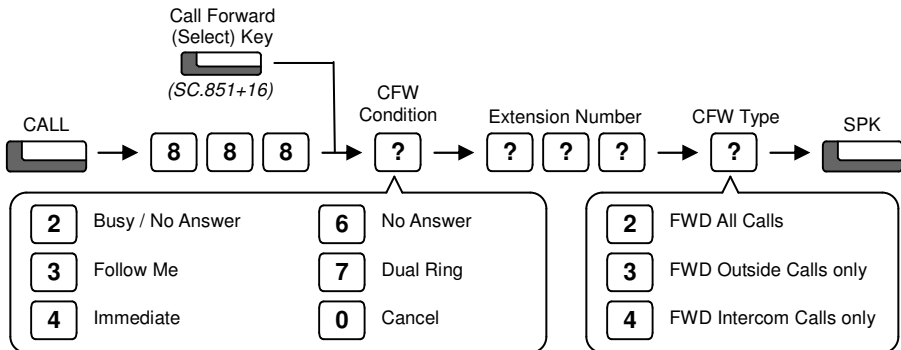

◆ When you set a Call Forward, the DND/CONF Key's lamp flashes and Internal Dial Tone pattern changes.

◆ When using a Call Forward (Select) Key, press the key and wait to cancel a Call Forward setting, then press the key and wait again to restore the previous Call Forward setting.

Call Forward Off-Premise

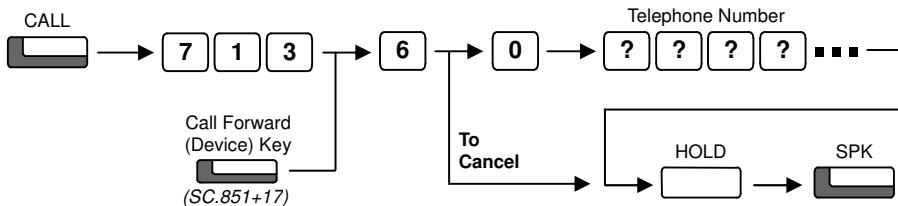

◆ When you set a Call Forward, the DND/CONF Key's lamp flashes and the Internal Dial Tone pattern changes.

Hard of hearing Options

Volume Controls

You can increase the volume of the **ringing** by pressing the VOL.▲ button while your phone is ringing or when the phone is idle by pressing SPK and dialling 829.

Ensure your phone is set to RING mode. See Answering an Intercom Call in this guide.

You can increase the volume of the **handset earpiece** by pressing the VOL.▲ button when the handset is off hook. *There are three volume settings (Low - Med - High).*

Visual indications

The **indicator lamp** at the top corner of the IPC 100 Display and System phone will flash RED to indicate various call types:

- **Intercom Call.** Your phone is ringing, the CALL key is flashing red and the display will show FROM and the callers name/number.
- **Outside Call.** Your phone is ringing, the display may show the callers name/number or RINGING.
- **Message Waiting.** *See Message Waiting in this guide.*
- **You may have a new Voice Mail Message.** *See the separate Voice Mail and Voice Response System User Guide.*

The **LCD display** of the IPC 100 Display phone will show the callers name and number for internal calls and also where available for outside calls.

Hearing Aid Compatibility

The earpiece within the handset of the IPC 100 Display and System handset has a built in inductive coupler and is compatible with hearing aids that have the 'T' setting.

Additional Options

The ringing tone/pitch can not be changed on the IPC 100 Display or System phones.

Consult the system supplier/installer for additional volume settings or equipment that may help.

EU REGULATORY INFORMATION

CE Notice (European Union)



Hereby, "Philips Business Communications", declares that this system terminal for the SOPHO IPC 100 is in compliance with the essential requirements and other relevant provisions of Directive 1999/5/EC. For a copy of the declaration of conformity please visit <http://www.sopho.philips.com/doc> or contact us at the address mentioned in this manual.

Nothing contained in this manual shall be deemed to be, and this manual does not constitute, a warranty of, or representation with respect to, any of the equipment covered. This manual is subject to change without notice and Philips Business Communications has no obligation to provide any updates or corrections to this manual. Further, Philips Business Communications also reserves the right, without prior notice, to make changes in equipment design or components as it deems appropriate. No representation is made that this manual is complete or accurate in all respects and Philips Business Communications shall not be liable for any errors or omissions. In no event shall Philips Business Communications be liable for any incidental or consequential damages in connection with the use of this manual. This document contains proprietary information that is protected by copyright. All rights are reserved. No part of this document may be photocopied or reproduced without prior written consent of Philips Business Communications.

Copyright © 2005 by Philips Business Communications
All Rights Reserved.

Philips Business Communications
P.O. Box 32
1200 JD Hilversum
The Netherlands

Issue 1.2 July 2006

Product disposal information

For countries in the European Union



The symbol depicted here has been affixed to your product in order to inform you that electrical and electronic products should never be disposed of as municipal waste.

Electrical and electronic products including the cables, plugs and accessories should be disposed of separately in order to allow proper treatment, recovery and recycling. These products should be taken to a designated facility where the best available treatment, recovery and recycling techniques are available. Separate disposal has significant advantages: valuable materials can be re-used and it prevents the dispersion of unwanted substances into the municipal waste stream. This contributes to the protection of human health and the environment.

Please be informed that a fine may be imposed for illegal disposal of electrical and electronic products via the general municipal waste stream.

In order to facilitate separate disposal and environmentally sound recycling, Philips Business Communications has made arrangements for local collection and recycling in all member states of the European Union. In case your electrical and electronic products need to be disposed of please refer to the contractual agreements that your company has made upon acquisition of these products. Should this information not be available, please contact the local Philips organization or contact us at www.sopho.philips.com.

For Countries outside the European Union

Disposal of electrical and electronic products in countries outside the European Union should be done in line with local regulations. If no arrangement has been made with Philips Business Communications or your supplier, please contact the local authorities for further information.

Free Manuals Download Website

<http://myh66.com>

<http://usermanuals.us>

<http://www.somanuals.com>

<http://www.4manuals.cc>

<http://www.manual-lib.com>

<http://www.404manual.com>

<http://www.luxmanual.com>

<http://aubethermostatmanual.com>

Golf course search by state

<http://golfingnear.com>

Email search by domain

<http://emailbydomain.com>

Auto manuals search

<http://auto.somanuals.com>

TV manuals search

<http://tv.somanuals.com>