

Poulan®

ENGLISH



Please do not return product to retailer.
Por favor, no devuelva el producto al lugar de compra.
Veuillez ne pas retourner le produit au détaillant.

1-800-554-6723

Register your product online at:
Registre su producto en línea en:
Enregistrez votre produit en ligne à l'adresse :
www.poulan.com

Instruction Manual Manual de Instrucciones Manuel d'Instructions

**ES350
ES350WT**

ESPAÑOL



WARNING:

Read and follow all Safety Rules and Operating Instructions before using this product. Failure to do so can result in serious injury.

ADVERTENCIA:

Lea el manual de instrucciones y siga todas las advertencias e instrucciones de seguridad. El no hacerlo puede resultar en lesiones graves.

AVERTISSEMENT:

Lire le manuel d'instructions et bien respecter tous les avertissements et toutes les instructions de sécurité. Tout défaut de le faire pourrait entraîner des blessures graves.

Poulan
7349 Statesville Road
Charlotte, NC 28269

Poulan
850 Matheson Blvd. West
Mississauga, Ontario L5V 0B4

FRANÇAIS

115259826 Rev. 2 4/15/10 BRW

SAFETY RULES

⚠ WARNING: When using electric gardening appliances, basic safety precautions must always be followed to reduce the risk of fire, electric shock, and serious injury. Read and follow all instructions.

⚠ WARNING: Always disconnect power source when making repairs, adjustments, and when changing accessories and attachments such as saw bar, chain or guards.

Because a chain saw is a high-speed woodcutting tool, special precautions must be observed to reduce risk of accidents. Careless or improper use of this tool can cause serious injury.

PLAN AHEAD

- Restrict the use of your saw to adult users who understand and can follow the safety rules, precautions, and operating instructions found in this manual.
- Dress properly. Wear protective gear. Always use steel-toed safety footwear with non-slip soles; snug-fitting clothing; heavy-duty, non-slip gloves; eye protection such as non-fogging, vented goggles or face screen; an approved safety hard hat; and sound barriers (ear plugs or mufflers) to protect your hearing. Regular users should have hearing checked regularly as chain saw noise can damage hearing.
- Secure hair above shoulder length. Do not wear loose clothing or jewelry; they can get caught in moving parts.

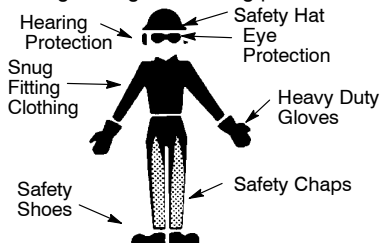

- Keep all parts of your body away from the chain when saw is running.
- Keep children away. Do not let visitors contact chain saw or extension cord. All visitors should be kept at least 30 feet (10 meters) away from work area.
- Do not handle or operate a chain saw when you are fatigued, ill, upset, or if you have taken alcohol, drugs, or me-

dication. You must be in good physical condition and mentally alert. If you have any condition that might be aggravated by strenuous work, check with doctor before operating. Watch what you are doing. Use common sense.

- Do not start cutting until you have a clear work area, secure footing, and especially if you are felling a tree, a retreat path. Keep work area clean.

OPERATE YOUR SAW SAFELY

- Do not operate with one hand. Serious injury to the operator, helpers, or bystanders may result from one-handed operation. A chain saw is intended for two-handed use.
- Do not operate saw from a ladder or in a tree.
- Make sure the chain will not make contact with any object while starting the saw. Never start the saw when the guide bar is in a cut.
- Do not force chain saw. It will do the job better and safer at the rate for which it was intended.
- Do not put pressure on the saw, especially at the end of the cut. Doing so can cause you to lose control when the cut is completed.
- Stop the saw before setting it down.
- Hand carry saw only when motor is stopped. Carry the chain saw by the front handle with the saw stopped, finger off the switch, the guide bar and saw chain to the rear.
- Use the right tool, cut wood only. Don't use chain saw for purpose not intended; for example, don't use chain saw for cutting plastic, masonry, non-wood building materials.
- Do not operate a chain saw that is damaged, improperly adjusted, or not completely and securely assembled. Always replace bar, chain, hand guard, or other parts immediately if they become damaged, broken, or are otherwise removed.
- Inspect chain saw cords periodically and if damaged, have repaired by an authorized service dealer.

MAINTAIN YOUR SAW IN GOOD WORKING ORDER

- Have all chain saw service performed by an authorized service dealer except the items listed in the MAINTENANCE section of this manual.
- Make certain saw chain stops moving when trigger switch is released.

- Keep the handles dry and clean and free from oil and grease.
- Keep oil cap and fasteners securely tightened.
- Nonconforming replacement components or the removal of safety devices may cause damage to the unit and possible injury to the operator or bystanders. Use only Poulan accessories and replacement parts as recommended. Never modify your saw.
- Maintain chain saw with care.
- Keep unit sharp and clean for better and safer performance.
- Follow instructions for lubricating and changing accessories.
- Unplug the chain saw from the power source when not in use, before servicing, and when changing accessories and attachments, such as saw chain and guard.
- Check for damaged parts. Before further use of the chain saw, a guard or other part that is damaged should be carefully checked to determine that it will operate properly and perform its intended function. Check for alignment of moving parts, binding of moving parts, breakage of parts, mounting and any other conditions that may affect its operation. A guard or other part that is damaged should be properly repaired or replaced by an authorized service dealer unless otherwise indicated elsewhere in the instruction manual.
- When not in use, chain saws should be stored in a dry, high or locked-up place out of the reach of children.
- When storing saw, unplug and use a bar sheath or carrying case.

ELECTRICAL SAFETY

- ⚠ WARNING:** Avoid a dangerous environment. To reduce the risk of electrical shock, do not use in rain, in damp or wet locations, or around swimming pools, hot tubs, etc. Do not expose to snow, rain, or water to avoid the possibility of electrical shock. Do not handle extension cord or plug with wet hands.
- Use a voltage supply as shown on the nameplate of the unit.
 - Avoid dangerous situations. Do not use in the presence of flammable liquids or gases to avoid creating a fire or explosion and/or causing damage to unit.
 - To reduce the risk of electrical shock, this appliance has a polarized plug (one blade is wider than the other) and will require the use of a polarized extension cord. The appliance plug will fit into a po-

- larized extension cord only one way. If the plug does not fit fully into the extension cord, reverse the plug. If the plug still does not fit, obtain a correct polarized extension cord. A polarized extension cord will require the use of a polarized wall outlet. This plug will fit into the polarized wall outlet only one way. If plug does not fit fully into the wall outlet, reverse the plug. If the plug still does not fit, contact a qualified electrician to install the proper wall outlet. Do not change the equipment plug, extension cord receptacle, or extension cord plug in any way.
- To reduce risk of electrical shock, use extension cords specifically marked as suitable for outdoor appliances. The electrical rating of the cord must not be less than the rating of unit. The cord must be marked with suffix "W-A" (in Canada, "W"). Use a polarized cord. Make sure your extension cord is in good condition. Inspect extension cord before use and replace if damaged. Do not use a damaged cord. Cord insulation must be intact with no cracks or deterioration. Plug connectors must be undamaged. An undersized extension cord will cause a drop in line voltage resulting in loss of power and overheating. If in doubt, use the next heavier gauge. The lower the gauge number, the heavier the cord (see SELECT AN EXTENSION CORD in the OPERATION section). Do not use multiple cords.
 - Do not abuse cord. Never carry the unit by the extension cord or yank extension cord to disconnect unit.
 - Secure extension cord to power cord to prevent disconnection from unit.
 - Do not use the unit if the switch does not turn the unit on and off properly, or if the lockout does not work. Repairs to the switch must be made by an authorized service dealer.
 - Keep extension cord clear of operator and obstacles at all times. Position cord so that it will not be caught on branches. Do not expose cords to heat, oil, water, or sharp edges.
 - To avoid the possibility of electric shock, avoid body contact with any grounded conductor, such as metal fences or pipes.
 - Ground Fault Circuit Interrupter (GFCI) protection should be provided on circuit or outlet to be used. Receptacles are available having built-in GFCI protection and may be used for this measure of safety. Inspect chain saw cords periodically and if damaged, have repaired by an authorized service dealer.

GUARD AGAINST KICKBACK

Follow all safety rules to help avoid kickback and other forces which can result in serious injury.

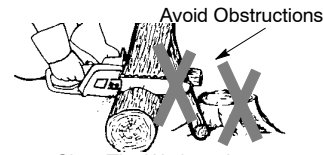
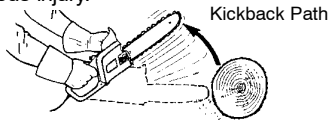

⚠ WARNING: Avoid kickback which can result in serious injury. **Kickback** is the backward, upward or sudden forward motion of the guide bar occurring when the saw chain near the upper tip of the guide bar contacts any object such as a log or branch, or when the wood closes in and pinches the saw chain in the cut. Contacting a foreign object in the wood can also result in loss of chain saw control.

- **Rotational Kickback** can occur when the moving chain contacts an object at the upper tip of the guide bar. This contact can cause the chain to dig into the object, which stops the chain for an instant. The result is a lightning fast, reverse reaction which kicks the guide bar up and back toward the operator.
- **Pinch-Kickback** can occur when the wood closes in and pinches the moving saw chain in the cut along the top of the guide bar and the saw chain is suddenly stopped. This sudden stopping of the chain results in a reversal of the chain force used to cut wood and causes the saw to move in the opposite direction of the chain rotation. The saw is driven straight back toward the operator.
- **Pull-In** can occur when the moving chain contacts a foreign object in the wood in the cut along the bottom of the guide bar and the saw chain is suddenly stopped. This sudden stopping pulls the saw forward and away from the operator and could easily cause the operator to lose control of the saw.

REDUCE THE CHANCE OF KICKBACK

The following precautions should be followed to minimize kickback:

- Recognize that kickback can happen. With a basic understanding of kickback, you can reduce the element of surprise which contributes to accidents.
- Never let the moving chain contact any object at the tip of the guide bar.
- Keep working area free from obstructions such as other trees, branches, rocks, fences, stumps, etc. Eliminate or avoid any obstruction that your saw chain could hit while cutting.
- When cutting a branch, do not let the guide bar contact another branch or other objects around it.
- Keep saw chain sharp and properly tensioned. A loose or dull chain can increase the chance of kickback. Follow manufacturer's chain sharpening and maintenance instructions. Check tension at regular intervals, but never with engine running. Make sure bar clamp nuts are securely tightened.
- Begin and continue cutting at full speed. If the chain is moving at a slower speed, there is greater chance of kickback occurring.
- Use extreme caution when re-entering a cut.
- Do not attempt cuts starting with the tip of the bar (plunge cuts).
- Watch for shifting logs or other objects that could close a cut and pinch or fall onto chain.
- Use the specified Reduced-Kickback Guide Bar and Low Kickback Chain.

Avoid Pinch-Kickback:

- Be extremely aware of situations or obstructions that can cause material to pinch the top of or otherwise stop the chain.
- Do not cut more than one log at a time.
- Do not twist the saw as the bar is withdrawn from an undercut when bucking.

Avoid Pull-In:

- Always begin cutting with the saw at full speed and the saw housing against wood.
- Use wedges made of plastic or wood. Never use metal to hold the cut open.

MAINTAIN CONTROL

- A good, firm grip on the saw with both hands will help you maintain control. Don't let go. Grip the rear handle with your right hand whether you are right or left handed. Wrap the fingers of your left hand over and around the front handlebar, and your left thumb under the front handlebar. Keep your left arm straight with the elbow locked.

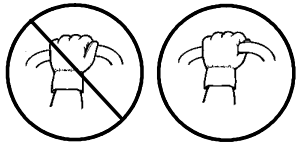
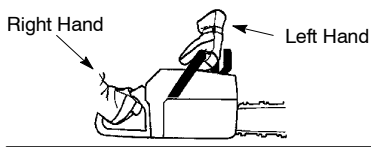

- Position your left hand on the front handlebar so it is in a straight line with your right hand on the rear handle when making bucking cuts. Stand slightly to the left side of the saw to keep your body from being in a direct line with the cutting chain.
- Stand with your weight evenly balanced on both feet.
- Do not overreach. You could be drawn or thrown off balance and lose control.
- Do not cut above shoulder height. It is difficult to maintain control of saw above shoulder height.

KICKBACK SAFETY FEATURES

WARNING: The following features are included on your saw to help reduce hazard of kickback; however, such features will not totally eliminate this danger. Do not rely only on safety devices. Follow all safety rules to help avoid kickback and other forces which can result in serious injury.

- Hand Guard: designed to reduce the chance of your left hand contacting the chain if your hand slips off the front handlebar.
- Position of front and rear handlebars: designed with distance between handles and "in-line" with each other. The spread and "in-line" position of the hands provided by this design work together to give balance and resistance in controlling the pivot of the saw back toward the operator if kickback occurs.
- Reduced-Kickback Guide Bar: designed with a small radius tip which reduces the size of the kickback danger zone. This type bar has been demonstrated to significantly reduce the number and seriousness of kickbacks when tested in accordance with ANSI B175.1.

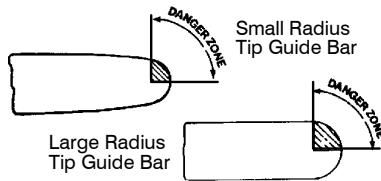

- Low Kickback Chain has met kickback performance requirements when tested on the representative sample of these chain saws specified in ANSI B175.1.

Low Kickback Chain

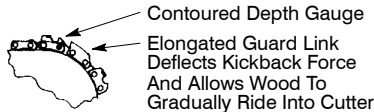

WARNING: Computed Kickback Angle (CKA) listed on your saw and listed in the following CKA Table represents the angle of kickback your bar and chain combinations will have when tested in accordance with CSA and ANSI standards. Computed angles represented in the CKA column indicate total energy and angle associated without a chain brake. When purchasing replacements, considerations should be given to the lower CKA values. In all cases, lower CKA values represent a safer operating environment for the user.

- Tip contact in some cases may cause a lightning fast REACTION, kicking the guide bar up and back toward the operator.
- Pinching the saw chain along the tip of the guide bar may push the guide bar rapidly back towards the operator.
- Either of these reactions may cause you to lose control of the saw which could result in serious injury. Do not rely exclusively upon safety devices built into your saw.

The following guide bar and chain combinations meet kickback requirements of CSA Z62.1 & Z62.3 and ANSI B175.1 when used on saws listed in this manual. Use of bar and chain combinations other than those listed is not recommended and may not meet the CKA requirements per standard.

Computed kickback angle (CKA) Table

MODEL	BAR		CHAIN P/N	CKA without chain brake
	P/N	Length		
ES350	952044370	16"	952051211	30°
ES350WT	952044370	16"	952051211	30°

SAFETY NOTICE: Exposure to vibrations through prolonged use of hand tools could cause blood vessel or nerve damage in the fingers, hands, and joints of people prone to circulation disorders or abnormal swelling. Prolonged use in cold weather has been linked to blood vessel damage in otherwise healthy people. If symptoms occur such as numbness, pain, loss of strength, change in skin color or texture, or loss of feeling in the fingers, hands, or joints, discontinue the use of this tool and seek medical attention. An anti-vibration system does not guarantee the avoidance of these problems. Users who operate power tools on a continual and regular basis must closely monitor their physical condition and the condition of this tool.

DOUBLE INSULATION CONSTRUCTION

This unit is double insulated to help protect against electric shock. Double insulation construction consists of two separate "layers" of electrical insulation instead of grounding.

Tools built with this insulation system are not intended to be grounded. No grounding means is provided on this unit, nor should a means of grounding be added to this unit.

Safety precautions must be observed when operating any electrical tool. The

double insulation system only provides added protection against injury resulting from an internal electrical insulation failure.

⚠ WARNING: All electrical repairs to this unit, including housing, switch, motor, etc., must be diagnosed and repaired by qualified service personnel. Replacement parts for a double insulated appliance must be identical to the parts they replace. A double insulated appliance is marked with the words "double insulation" or "double insulated". The symbol  (square within a square) may also be marked on the appliance. Failure to have the unit repaired by authorized service personnel can cause the double insulation construction to become ineffective and result in serious injury.

STANDARDS: This product is listed by Underwriters Laboratories, Inc. in accordance with UL Standard 1662 and CSA Standards Z62.1 and Z62.3 and ANSI B175.1.

ANSI B175.1-2000 "American National Standard for Powered Tools - Safety Requirements"

CSA Z62.3 "Chain Saw Kickback Occupational Health and Safety"

CSA Z62.1 "Chain Saws - Occupational Health and Safety"

SAVE THESE INSTRUCTIONS

ASSEMBLY

⚠ WARNING: Before using chain saw, ensure all fasteners are secure.

CARTON CONTENTS

- Chain Saw (fully assembled)
- Bar Sheath

Examine parts for damage. Do not use damaged parts.

NOTE: If you need assistance or find that parts are missing or damaged, please call 1-800-554-6723.

ASSEMBLY

Your unit is fully assembled; no assembly is required.

OPERATION

KNOW YOUR SAW

READ THIS INSTRUCTION MANUAL AND SAFETY RULES BEFORE OPERATING YOUR CHAIN SAW. Compare the illustrations with your unit to familiarize yourself with the location of the various controls and adjustments. Save this manual for future reference.

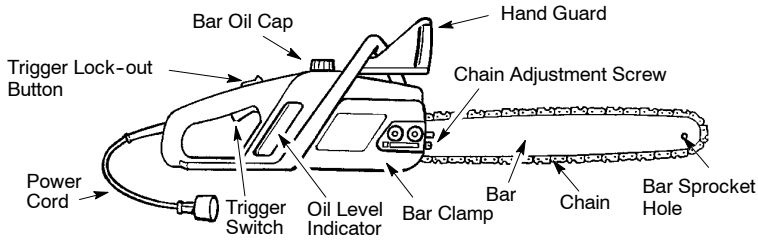

TRIGGER SWITCH

The TRIGGER SWITCH is used to turn on the unit. Squeeze the trigger switch to operate the unit after lock-out button has been pushed forward. Release the trigger to turn the unit off.

TRIGGER LOCK-OUT BUTTON

The TRIGGER LOCK-OUT BUTTON is a control feature designed to prevent the motor from being accidentally started. When the rear handle is gripped in a normal cutting position, the lock-out button can be pushed in by the thumb, permitting the index finger to squeeze the trigger. It is not necessary to maintain pressure on the lock-out button once the trigger has been engaged.

BAR OIL CAP

The BAR OIL CAP is used to fill the bar oil tank.

CHAIN ADJUSTMENT SCREW

The CHAIN ADJUSTMENT SCREW is used to adjust the chain tension.

POWER CORD

The POWER CORD is used to connect the chain saw to an approved extension cord.

CHAIN TENSION

It is normal for a new chain to stretch during first 15 minutes of operation. You should check your chain tension frequently. Readjust chain after every 15 minutes of operation. See CHECK CHAIN TENSION under the MAINTENANCE section.

OPERATING INSTRUCTIONS

Use only a voltage supply as specified on your unit.

SELECT AN EXTENSION CORD

MINIMUM WIRE GAUGE RECOMMENDATIONS			
Volts	25 ft. (7.67 m)	50 ft. (15.24 m)	100 ft. (30.48 m)
120	16 A.W.G.*	16 A.W.G.*	14 A.W.G.*

*American Wire Gauge

ATTACH THE EXTENSION CORD TO YOUR CHAIN SAW

To prevent disconnection from unit, secure extension cord to power cord as shown in the following illustration.

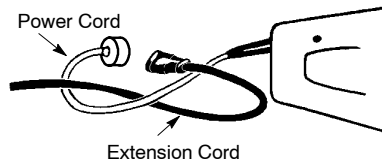

BEFORE STARTING SAW

WARNING: Be sure to read the electrical safety information in the safety rules section of this manual before you begin. If you do not understand the electrical safety information do not attempt to use your unit. Seek help from someone that does understand the information or call the customer assistance help line at 1-800-554-6723.

GUIDE BAR AND CHAIN OIL

The bar and chain require lubrication. The chain oiler provides lubrication to the chain and guide bar. Be sure to fill the bar oil tank before each cutting session. Lack of oil will quickly ruin the bar and chain. Too little oil will cause overheating shown by smoke coming from the chain and/or discoloration of the bar. For maximum guide bar and chain life, we recommend you use Poulan chain saw bar oil. If Poulan bar oil is not available, you may use a good grade SAE 30 oil until you are able to obtain Poulan brand. Use a funnel to fill the tank. Replace oil cap securely. Check oil level after every 15 minutes of operation.

STOPPING YOUR SAW

- Release the trigger switch.
- If motor does not stop, disconnect the extension cord. Discontinue use of the unit until it has been repaired by an authorized service dealer.

STARTING YOUR SAW

1. Connect the saw to a power source using the proper size extension cord; see SELECT AN EXTENSION CORD).
2. Grip both handles firmly.
3. Push and hold the trigger lock-out button with your right hand thumb.
4. Squeeze and hold the trigger switch.

CUTTING METHODS

OPERATING TIPS

- Check chain tension before first use and after 1 minute of operation. See CHECK CHAIN TENSION in the MAINTENANCE section.
- Cut wood only. Do not cut metal, plastics, masonry, non-wood building materials, etc.
- Stop the saw if the chain strikes a foreign object. Inspect the saw and repair parts as necessary.
- Keep the chain out of dirt and sand. Even a small amount of dirt will quickly dull a chain and increase the possibility of kickback.
- Practice cutting a few small logs using the following steps. This will help you get the "feel" of using your saw before you begin a major sawing operation.
 - Squeeze trigger switch and allow unit to reach full speed before cutting.
 - Begin cutting with the saw frame against the log.
 - Keep the motor at full speed the entire time you are cutting.
 - Release the trigger switch as soon as the cut is completed, allowing the motor to stop.
 - Keep the cord away from the cutting area. Position cord so it will not be caught on branches and the like during cutting.
 - To avoid losing control when cut is complete, do not put pressure on saw at end of cut.
- Stop motor before setting saw down.

TREE FELLING TECHNIQUES

- **WARNING:** Check for broken or dead branches which can fall while cutting causing serious injury. Do not cut near buildings or electrical wires if you do not know the direction of tree fall, nor cut at night since you will not be able to see well, nor during bad weather such as rain, snow, or strong winds, etc. If the tree does make contact with any utility line, the utility company should be notified immediately.
- Carefully plan your sawing operation in advance.
- Clear the work area. You need a clear area all around the tree so you can have secure footing.
- The chain saw operator should keep on the uphill side of the terrain as the tree is likely to roll or slide downhill after it is felled.
- Study the natural conditions that can cause the tree to fall in a particular direction, such as:
 - The wind direction and speed.
 - The lean of the tree. The lean of a tree might not be apparent due to uneven or sloping terrain. Use a plumb or level to determine the direction of tree lean.
 - Weight and branches on one side.
 - Surrounding trees and obstacles.
- Look for decay and rot. If the trunk is rotted, it can snap and fall toward the operator.
- Make sure there is enough room for the tree to fall. Maintain a distance of 2-1/2 tree lengths from the nearest person or other objects. Noise can drown out a warning call.

- Remove dirt, stones, loose bark, nails, staples, and wire from the tree where cuts are to be made.

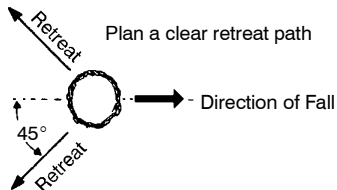

FELLING LARGE TREES

(6 inches in diameter or larger)

The notch method is used to fell large trees. A notch is cut on the side of the tree in the desired direction of fall. After a felling cut is made on the opposite side of tree, the tree will tend to fall in the direction of the notch.

NOTE: If tree has large buttress roots, remove them before making the notch. If using saw to remove buttress roots, keep saw chain from contacting ground to prevent dulling of the chain.

NOTCH CUT AND FELLING TREE

- Make notch cut by cutting the top of the notch first. Cut through 1/3 of the diameter of the tree. Next complete the notch by cutting the bottom. See illustration. Once the notch is cut, remove the wedge of wood from tree.

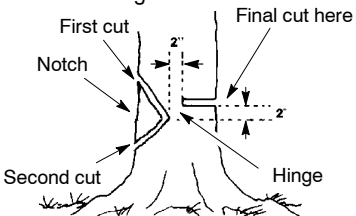

- After removing the wood from the notch, make the felling cut on the opposite side of the tree. This is done by making a cut about two inches higher than the center of the notch. This will leave enough uncut wood between the felling cut and the notch to form a hinge. This hinge will help prevent the tree from falling in the wrong direction.

Hinge holds tree on stump and helps control fall.

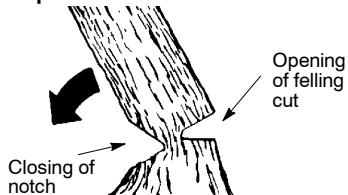

NOTE: Before felling cut is complete, use wedges to open the cut when necessary to control the direction of fall. To avoid kickback and chain damage, use wood or plastic wedges, but never steel or iron wedges.

- Be alert to signs that the tree is ready to fall: cracking sounds, widening of the felling cut, or movement in the upper branches.
- As tree starts to fall, stop saw, put it down, and get away quickly on your planned retreat path.
- DO NOT use your saw to cut down a partially fallen tree. Be extremely cautious with partially fallen trees that may be poorly supported. When a tree doesn't fall completely, set saw aside and pull down tree with a cable winch, block and tackle, or tractor.

CUTTING A FALLEN TREE (BUCKING)

Bucking is the term used for cutting a fallen tree to the desired log size.

WARNING: Do not stand on the log being cut. Any portion can roll causing loss of footing and control. Do not stand downhill of the log being cut.

IMPORTANT POINTS

- Cut only one log at a time.
- Cut shattered wood very carefully; sharp pieces of wood could be flung toward operator.
- Use a sawhorse to cut small logs. Never allow another person to hold the log while cutting and never hold the log with your leg or foot.
- Do not cut in an area where logs, limbs, and roots are tangled. Drag logs into a clear area before cutting them by pulling out exposed and cleared logs first.

BUCKING TECHNIQUES

WARNING: If saw becomes pinched or hung in a log, don't try to force it out. You can lose control of the saw resulting in injury and/or damage to the saw. Stop the saw, drive a wedge of plastic or wood into the cut until the saw can be removed easily. Restart the saw and carefully reenter the cut. Do not use a metal wedge. Do not attempt to restart your saw when it is pinched or hung in a log.

Use a wedge to remove pinched saw



Turn saw **OFF** and use a plastic or wooden wedge to force cut open.

Overcutting begins on the top side of the log with the bottom of the saw against the log. When overcutting use light downward pressure.

Overcutting

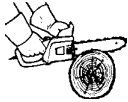

Undercutting

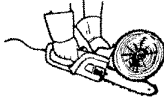

Undercutting involves cutting on the underside of the log with top of saw against the log. When undercutting use light upward pressure. Hold saw firmly and maintain control. The saw will tend to push back toward you.

⚠ WARNING: Never turn saw upside down to undercut. The saw cannot be controlled in this position.

Always make your first cut on the compression side of the log. The compression side of the log is where the pressure of the log's weight is concentrated.

First cut on compression side of log

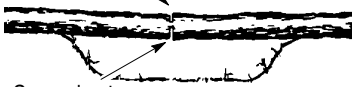

Second cut

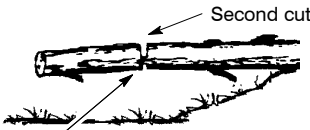

First cut on compression side of log

BUCKING WITHOUT A SUPPORT

- Overcut through 1/3 of the diameter of the log.
- Roll the log over and finish with a second overcut.
- Watch for logs with a compression side to prevent the saw from pinching. See illustration above for cutting logs with a compression side.

BUCKING USING A LOG OR SUPPORT STAND

- Remember your first cut is always on the compression side of the log. (Refer to the illustration below for your first and second cut)
- Your first cut should extend 1/3 of the diameter of the log.
- Finish with your second cut.

Using a log for support

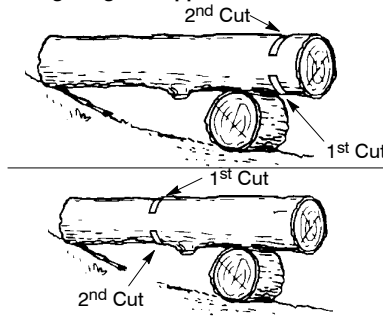

Using a support stand

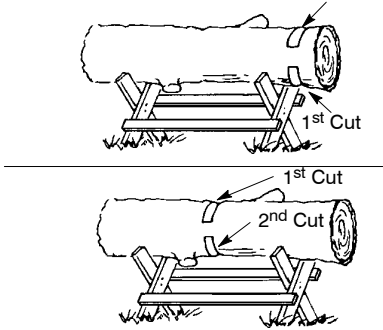

LIMBING AND PRUNING

⚠ WARNING: Be alert for and guard against kickback. Do not allow the moving chain to contact any other branches or objects at the nose of the guide bar when limbing or pruning. Allowing such contact can result in serious injury.

⚠ WARNING: Never climb into a tree to limb or prune. Do not stand on ladders, platforms, a log, or in any position which can cause you to lose your balance or control of the saw.

IMPORTANT POINTS

- Watch out for spring poles. Spring poles are small size limbs which can whip toward you or pull you off balance. Use extreme caution when cutting small size limbs.
- Be alert for spring back from any branches that are bent or under pressure. Avoid being struck by the branch or the saw when the tension in the wood fibers is released.
- Frequently clear branches out of the way to avoid tripping over them.

LIMBING

- Limb a tree only after it is cut down.
- Leave the larger limbs underneath the felled tree to support the tree as you work.
- Start at the base of the felled tree and work toward the top, cutting branches and limbs. Remove small limbs with one cut.
- Keep tree between you and the chain.
- Remove larger branches with the cutting techniques described BUCKING WITHOUT A SUPPORT.
- Always use an overcut to cut small and freely hanging limbs. Undercutting could cause limbs to fall and pinch the saw.

PRUNING

⚠ WARNING: Limit pruning to limbs shoulder height or below. Do not cut if branches are higher than your shoulder. Get a professional to do the job.

- Make your first cut 1/3 of the way through the bottom of the limb. This cut will make the limb sag so that it falls easily on the second cut.
- Next make a second cut **all the way through the limb.**
- Finish the pruning operation by using an overcut so that the stump of the limb protrudes 1 to 2 inches (3-5 cm) from the trunk of the tree.

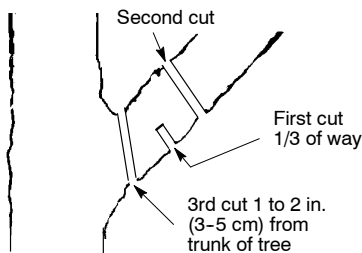

MAINTENANCE

CUSTOMER RESPONSIBILITIES

⚠ WARNING: Disconnect power source before performing maintenance.

Fill in dates as you complete regular service	Before Use	After Use	Every 15 min.	Service Dates
Check for damaged/worn parts	✓			
Check for loose fasteners/parts	✓			
Check chain tension	✓			
Check chain sharpness	✓			
Check guide bar	✓			
Check bar and chain oil level	✓		✓	
Inspect and clean unit & labels		✓		
Clean guide bar groove		✓		

GENERAL RECOMMENDATIONS

The warranty on this unit does not cover items that have been subjected to operator abuse or negligence. To receive full value from the warranty, the operator must maintain unit as instructed in this manual. Various adjustments will need to be made periodically to properly maintain your unit. Improper maintenance may cause damage to the unit and possible injury to the operator or bystanders.

CHECK FOR DAMAGED OR WORN PARTS

Contact an authorized service dealer for replacement of worn or damaged parts.

NOTE: It is normal for a small amount of oil to appear under the saw after motor stops. Do not confuse this with a leaking oil tank.

- Trigger Switch - Ensure the trigger switch functions properly by squeezing and holding the trigger switch. Make sure motor starts and stops.
- Oil Tank - Discontinue use of chain saw if oil tank shows signs of damage or leaks.
- Extension Cord - Discontinue use if chain saw extension cord shows signs of damage or wear.

CHECK FOR LOOSE FASTENERS AND PARTS

- Bar Clamp Nuts
- Chain
- Bar Adjusting Screw

CHECK CHAIN TENSION

WARNING: Wear protective gloves when handling chain. The chain is sharp and can cut you even when it is not moving.

Chain tension is very important. Chain stretches during use. This is especially true during the first few times you use your saw. Always check chain tension each time you use your saw.

1. Unplug unit from the power source.
2. Use a screwdriver to move chain around guide bar to ensure kinks do not exist. The chain should rotate freely.

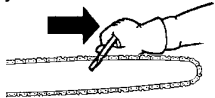

NOTE: It is recommended that the saw be turned upside down for chain tensioning.

3. Loosen bar clamp nuts until they are finger tight against the bar clamp.
4. Turn the adjusting screw clockwise until the chain solidly contacts bottom of guide bar rail. Then, turn adjusting screw an additional 1/4 turn. This is correct chain tension setting.

Adjusting Screw - 1/4 Turn



NOTE: To tighten the chain, turn the adjusting screw clockwise; to loosen the chain, turn the adjusting screw counter-clockwise.

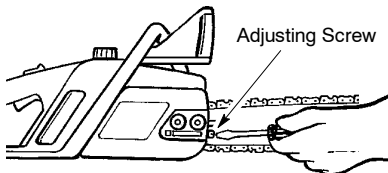

5. Check the tension by lifting the chain from the guide bar. Remove some of the stiffness in the chain by pulling down and letting go of the chain several times.
6. Continue turning the adjusting screw until the tension is correct (see step 4).
7. Tighten bar clamp nuts with a wrench.
8. Recheck chain tension.

WARNING: If the saw is operated with a loose chain, the chain could jump off the guide bar and result in serious injury.

CHECK CHAIN SHARPNESS

A sharp chain makes wood chips. A dull chain makes a sawdust powder and cuts slowly. See CHAIN SHARPENING in the SERVICE AND ADJUSTMENTS section.

CHECK GUIDE BAR

Conditions which require guide bar maintenance:

- Saw cuts to one side or at an angle.
- Saw has to be forced through the cut.
- Inadequate supply of oil to the bar and chain.

Check the condition of the guide bar each time the chain is sharpened. A worn guide bar will damage the chain and make cutting difficult.

After each use, with unit disconnected from power source, clean all sawdust from the guide bar and sprocket hole.

To maintain guide bar:

- Disconnect the chain saw from the power source.
- Loosen and remove bar clamp nuts. Remove bar and chain from saw.
- Clean the oil holes and bar groove after each 5 hours of operation.

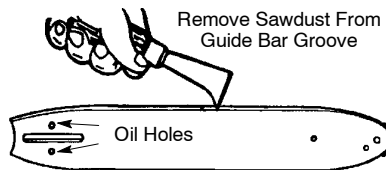

- Burring of guide bar rails is a normal process of rail wear. Remove these burrs with a flat file.
- When rail top is uneven, use a flat file to restore square edges and sides.

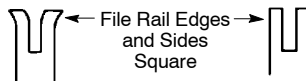

Worn Groove

Correct Groove

Replace the guide bar when the groove is worn, the guide bar is bent or crack-ed, or when excess heating or burring of the rails occurs. If replacement is necessary, use only the guide bar specified for your saw in the repair parts list or on the decal located on the chain saw.

LUBRICATION

Bar Oil Fill Cap

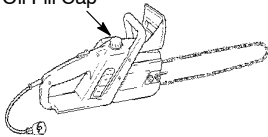

- Check bar and chain oil before use and every 15 minutes while operating the saw. See GUIDE BAR AND CHAIN OIL under the OPERATION section.

INSPECT AND CLEAN UNIT AND LABELS

- After each use, inspect complete unit for loose or damaged parts. Clean the unit and labels using a damp cloth with a mild detergent.
- Wipe off the unit and labels with a clean dry cloth.

SERVICE AND ADJUSTMENTS

CHAIN SHARPENING

⚠ WARNING: Improper chain sharpening techniques and/or depth gauge maintenance will increase the chance of kickback which can result in serious injury.

⚠ WARNING: Wear protective gloves when handling chain. The chain is sharp and can cut you even when it is not moving.

Conditions which indicate the need for chain sharpening:

- Reduction in size of wood chips. The size of the wood chip will decrease as the chain gets duller until it becomes more like a powder than a chip. Note that dead or rotted wood will not produce a good chip.
- Saw cuts to one side or at an angle.
- Saw has to be forced through the cut.

Tools required:

- 5/32 inch (4 mm) diameter round file and file holder
- Flat file
- Depth gauge tool

TO SHARPEN CHAIN:

1. Move ON/STOP switch to the STOP position.
2. Check chain for proper tension. Adjust chain tension if necessary. See CHECK CHAIN TENSION section.
3. Sharpen cutters.
 - To sharpen the cutters, position the file holder level (90°) so that it rests on the top edges of the cutter and depth gauge.

NOTE: The chain has both left and right hand cutters.

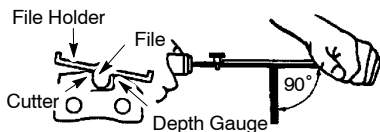

- Align the 30° file holder marks parallel with the bar and to the center of the chain.

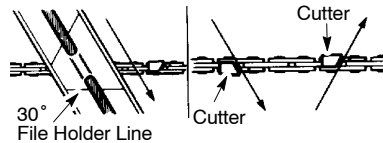

- Sharpen cutters on one side of the chain first. File from the inside of each cutter to the outside. Then, turn the chain saw around and repeat the process for the other side of the chain.
- File on the forward stroke only. Use 2 or 3 strokes per cutting edge.
- Keep all cutters the same length when filing.
- File enough to remove any damage to cutting edges (side plate and top plate of cutter).

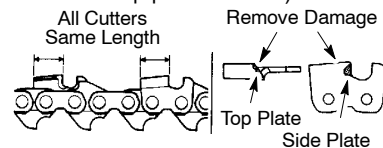

- File chain to meet the specifications as shown.

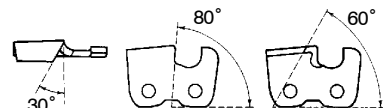

Hook Angle

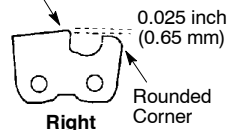

Right

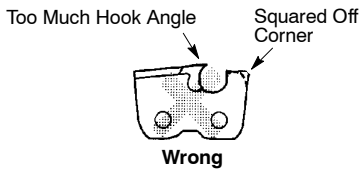

⚠ WARNING: Maintain the proper hook angle according to the manufacturer's specifications for the chain you are using. Improper hook angle will increase the chance of kickback which can result in serious injury.

4. Check and lower depth gauges.

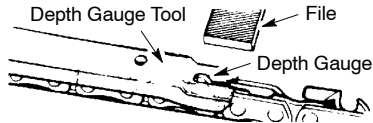

- Place gauge tool on cutter.
- If the depth gauge is higher than the depth gauge tool, file it level to the top of the depth gauge tool.
- Maintain rounded front corner of depth gauge with a flat file.

NOTE: The very top of the depth gauge should be flat with the front half rounded off with a flat file.

If you require further assistance or are unsure about performing this procedure, contact your authorized service dealer or call our customer assistance help line at 1-800-554-6723.

⚠ WARNING: Avoid accidental starting. Always unplug saw from power source before installing a bar and/or chain.

CHAIN REPLACEMENT

⚠ WARNING: Wear protective gloves when handling chain. The chain is sharp and can cut you even when it is not moving.

It is normal for a new chain to stretch during the first 15 minutes of operation. You should recheck your chain tension frequently and adjust the chain tension as required. See CHECK CHAIN TENSION section.

Replace the old chain when it becomes worn or damaged. Use only the Low Kickback replacement chain specified in the list of available replacement parts. The chain must comply with kickback requirements of ANSI B175.1 when tested with this saw. See your authorized service dealer to replace and sharpen individual cutters on your chain.

TO REPLACE CHAIN:

1. Disconnect the chain saw from the power source.
2. Remove bar clamp nuts.
3. Remove bar clamp and old chain.

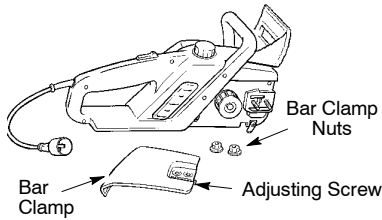

4. Turn the adjusting screw counter-clockwise to move the adjusting pin almost as far as it will go to the rear. Do not remove the adjusting screw from the bar clamp.
5. Carefully remove the new chain from the package. Hold chain with cutters facing as shown.

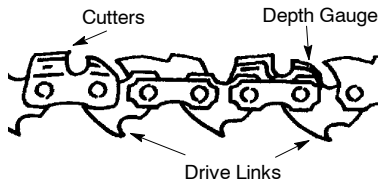
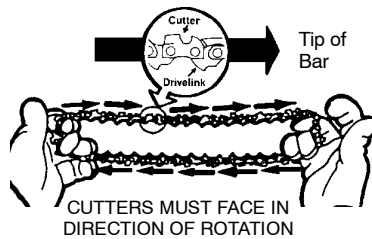

6. Place chain around the sprocket and fit the drive links into the guide bar groove and then into the teeth of the sprocket in the tip of the guide bar.

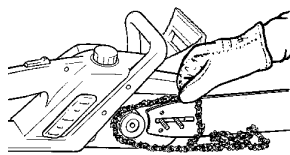

7. Hold the guide bar against the saw frame and install the bar clamp. Be sure adjusting pin is in the adjusting pin hole in the bar.

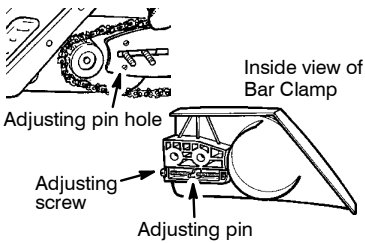

CUSTOMER SERVICEABLE PARTS

⚠ WARNING: Use of any other accessory or attachment might present a risk of injury to the operator.

8. Secure the guide bar and bar clamp with the bar clamp nuts; tighten finger tight *only*.

CAUTION: If saw chain is installed backwards, the saw will vibrate excessively and will not cut wood.

CHAIN ADJUSTMENT

See CHECK CHAIN TENSION in the MAINTENANCE section.

REPLACEMENT PART	PART NO.
Hex Nuts	530015917
Oil Cap	530053072
Bar Adjusting Screw	530016265
Bar Adjusting Pin	530053068
File (5/32" dia.) Twin Pak	952055085
Xtra GUARD® Chain - 16"	952051470
Lo-Kick® Guide Bar - 16"	952044759
Bar & Chain Lubricant - 1 qt.	952030129
Bar & Chain Lubricant - 1 gal.	952030130

STORAGE

⚠ WARNING: Perform the following steps after each use:

- Allow motor to cool before storing or transporting.
- Store chain saw and extension cord in a well ventilated area
- Store chain saw with all guards in place and position chain saw so that any sharp object cannot accidentally cause injury.
- Store chain saw unplugged, well out of the reach of children.

SEASONAL STORAGE

Prepare your unit for storage at the end of the season or if it will not be used for 30 days or more.

If your chain saw is to be stored for a period of time:

- Clean it thoroughly before lengthy storage.
- Store in a clean dry area.
- Lightly oil external metal surfaces and guide bar.
- Oil the chain and wrap it in heavy paper or cloth.

TROUBLESHOOTING TABLE

⚠ WARNING: Always stop unit and disconnect from the power source before performing all of the recommended remedies below except remedies that require unit to be operating.

TROUBLE	CAUSE	REMEDY
Chain does not move when trigger switch is engaged.	<ol style="list-style-type: none"> 1. Chain tension incorrect. 2. Guide bar rails pinched. 3. Trigger switch failure. 4. Circuit breaker tripped/fuse failure. 	<ol style="list-style-type: none"> 1. See "Check Chain Tension" in Maintenance section. 2. Repair or replace. 3. Contact an authorized service dealer. 4. Reset circuit breaker or replace fuse.
Chain clatters or cuts roughly.	<ol style="list-style-type: none"> 1. Chain tension incorrect. 2. Cutters damaged. 3. Chain worn. 4. Cutters dull, improperly sharpened, or depth gauges too high. 5. Sprocket worn. 	<ol style="list-style-type: none"> 1. See "Check Chain Tension" in Maintenance Section. 2. Contact an authorized service dealer. 3. Resharpener or replace chain. 4. See "Chain Sharpening" in Service and Adjustments section. 5. Contact an authorized service dealer.
Chain stops during cut.	<ol style="list-style-type: none"> 1. Chain cutter tops not filed flat. 2. Guide bar burred or bent; rails uneven. 	<ol style="list-style-type: none"> 1. See "Chain Sharpening" in Service and Adjustments section. 2. Repair or replace guide bar.
Oil inadequate for bar and chain lubrication.	<ol style="list-style-type: none"> 1. Oil tank empty. 2. Oil outlet clogged. 3. Guide bar oil hole blocked. 	<ol style="list-style-type: none"> 1. Fill oil tank. 2. Contact an authorized service dealer. 3. Remove bar and clean.
Chain cuts at an angle.	<ol style="list-style-type: none"> 1. Cutters damaged on one side. 2. Chain dull on one side. 3. Guide bar bent or worn. 	<ol style="list-style-type: none"> 1. See "Chain Sharpening" in Service and Adjustments section. 2. See "Chain Sharpening" in Service and Adjustments section. 3. Replace guide bar.

WARRANTY STATEMENT

Poulan, a division of Husqvarna Consumer Outdoor Products N.A., Inc., warrants to the original consumer purchaser that each new **Poulan** brand electric or cordless product is free from defects in material and workmanship and agrees to repair or replace under this warranty any defective **Poulan** brand electric product within one (1) year from the original date of purchase.

If your **Poulan** brand electric or cordless product should fail within the limited warranty period, you may return it in complete condition, prepaid, with proof of purchase to the dealer from whom it was purchased for repair or replacement at the option of **Poulan**.

This warranty is not transferable and does not cover damage or liability caused by improper handling, improper maintenance or alteration, or the use of accessories and/or attachments not specifically recommended by **Poulan** for this product. This warranty does not cover parts that will wear and require replacement with reasonable use during the warranty period. This warranty does not cover pre-delivery setup or normal adjustments explained in the instruction manual.

Should you have any unanswered questions regarding this warranty, please contact:

Poulan, a division of Husqvarna
Consumer Outdoor Products N.A., Inc.
7349 Statesville Road
Charlotte, NC 28269
1-800-554-6723

In Canada, contact:

Poulan
850 Matheson Blvd. West
Mississauga, Ontario L5V 0B4

Giving the model number, serial number and date of purchase of your product and the name and address of the authorized dealer from whom it was purchased.

THIS WARRANTY GIVES YOU SPECIFIC LEGAL RIGHTS, AND YOU MAY HAVE OTHER RIGHTS WHICH VARY FROM STATE TO STATE.

NO CLAIMS FOR CONSEQUENTIAL OR OTHER DAMAGES WILL BE ALLOWED, AND THERE ARE NO OTHER EXPRESS WARRANTIES EXCEPT THOSE EXPRESSLY STIPULATED HEREIN.

SOME STATES DO NOT ALLOW LIMITATIONS ON HOW LONG AN IMPLIED WARRANTY LASTS OR THE EXCLUSION OR LIMITATIONS OF INCIDENTAL OR CONSEQUENTIAL DAMAGES, SO THE ABOVE LIMITATIONS OR EXCLUSION MAY NOT APPLY TO YOU.

This is a limited warranty within the meaning of that term as defined in the Magnuson-Moss Act of 1975.

The policy of **Poulan** is to continuously improve its products. Therefore, **Poulan** reserves the right to change, modify, or discontinue models, designs, specifications, and accessories of all products at any time without notice or obligation to any purchaser.

Free Manuals Download Website

<http://myh66.com>

<http://usermanuals.us>

<http://www.somanuals.com>

<http://www.4manuals.cc>

<http://www.manual-lib.com>

<http://www.404manual.com>

<http://www.luxmanual.com>

<http://aubethermostatmanual.com>

Golf course search by state

<http://golfingnear.com>

Email search by domain

<http://emailbydomain.com>

Auto manuals search

<http://auto.somanuals.com>

TV manuals search

<http://tv.somanuals.com>