

Poulan Chain Saw

OWNER'S MANUAL

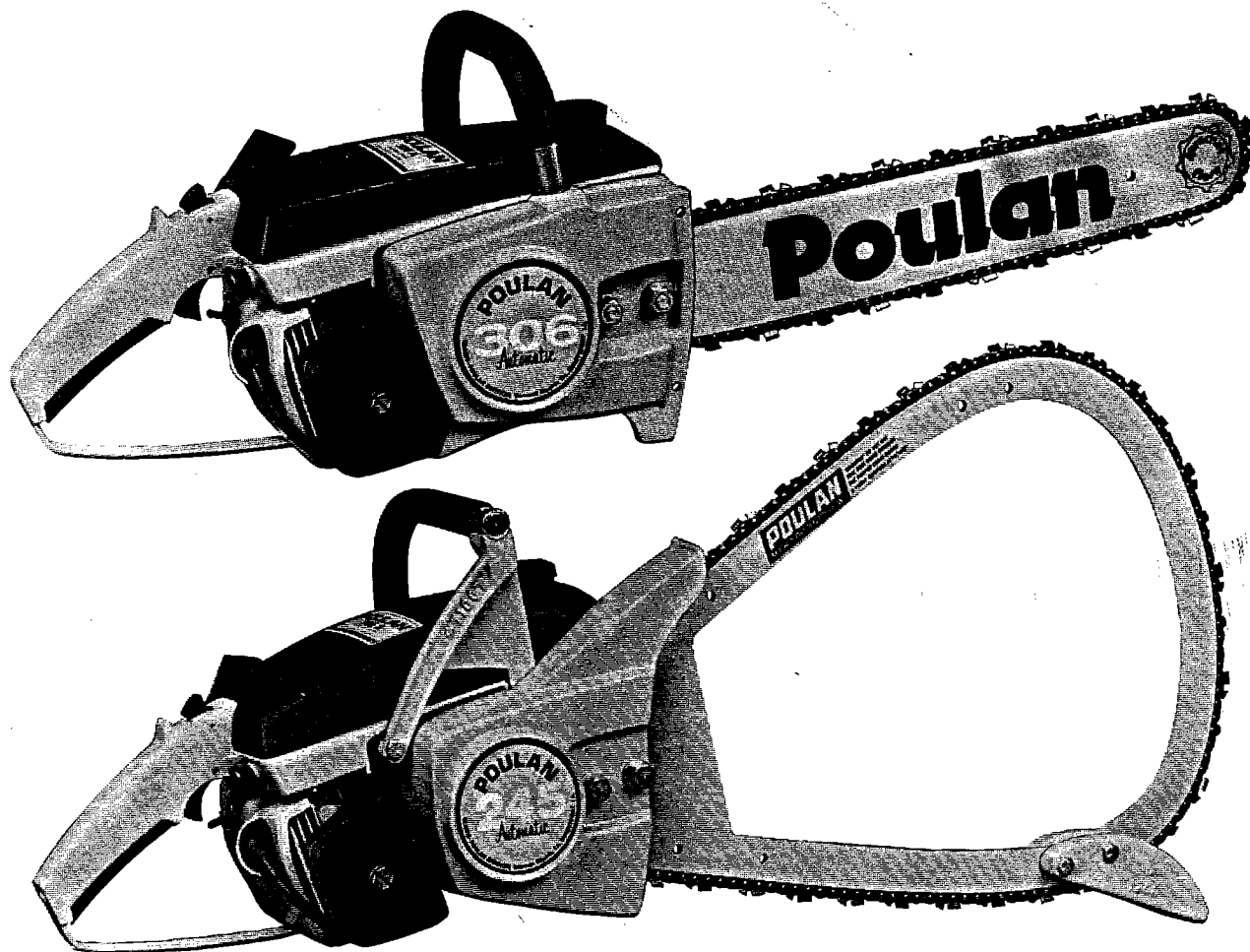

CAUTION:
Read Rules for Safe
Operation Carefully.

Record in the space provided below the model number and serial number of your saw.

Model No. _____ Serial No. _____

Retain these numbers for future reference.

bp **Beaird-Poulan Division**
Emerson Electric Co.
Shreveport, Louisiana

SAFETY FIRST

▼ DON'T

- Don't use the saw when you are tired
- Don't start cutting until you have a clear work area, secure footing, and a planned retreat from a falling tree
- Don't use a saw that is damaged or poorly adjusted
- Don't touch a moving chain
- Don't use the saw in an enclosed area

▼ DO

- Wear safe footwear, snug-fitting clothing, and eye, hearing, and head protection
- Be careful handling fuel
- Hold the saw firmly with both hands
- Carry the saw with the engine stopped, the bar and chain to the rear, and the muffler away from you
- Shut off the engine before setting it down
- Keep the handles free of oil and fuel
- Keep others out of the work area when the saw is running

▼ BE CAREFUL

- Don't climb in a tree with a saw — it is very dangerous. Get professional help.
- Be careful cutting small branches and bushes— small limbs may catch the chain and be whipped toward you.

■ LOOK OUT FOR KICKBACK

- When the moving chain at the nose of the bar touches an object, the bar and chain can be thrown upward with considerable force. This is **KICKBACK!**
- Hold the saw firmly with both hands
- Don't overreach
- Don't let the nose of the bar contact a log, branch, etc.
- Cut only at high engine speeds
- Don't reach above shoulder height to cut — the chain is too close to your face in this position
- Keep your chain sharp

▼ Safety First

GENERAL TIPS

- Dress Safely — Loose clothing may get caught in moving parts.
- It's A One Man Job — Keep others out of the work area when the engine is running.
- LOOK OUT FOR KICKBACK — Don't let the tip of the bar touch anything while the engine is running:

Take care of your saw

- Keep the Chain Out of the Dirt — Even a small amount of dirt on the log will dull the chain quickly.
- Keep the Chain Sharp — A dull chain is unsafe and will cause excessive wear to other parts.
- Don't Force the Saw Out of a Jam — Use a wedge, an axe, a crowbar, or another saw, but don't force it out.

What is good performance?

- Wood Chips Tell You A Lot — The chips should be about the size of the chain teeth. If they are small and powder like, your chain is dull. Get it Sharpened!
- Don't Press Hard — Light pressure is enough. Heavy pressure can cause unsafe conditions. Check for a dull chain or worn bar. (See Guide Bar Maintenance and Chain Sharpening).
- Cut Only At High Speeds — Keep the throttle wide open when cutting. Don't run the engine at high speed when not cutting!
- It Should Cut Smoothly — If the engine stalls or bogs with light pressure, check the carburetor setting and the air filter.
- Performance and Safety — Keep your saw running well and your work will be easier and safer.

TABLE OF CONTENTS

Bar and Chain Installation	4
Chain Adjustment	4
Bow Installation	4
Operating Instructions	5
Cutting Tips	5
Bow Cutting Tips	5
Felling	6
Bucking	6
Pruning and Debranching	7
Care and Maintenance	7
Chain Sharpening	8

SPECIFICATIONS

	306A	245A
CU. IN. DISPLACEMENT	3.6 cu. in./59cc	4.5 cu. in./74cc
SPARK PLUG	Champion CJ-8	Champion CJ-8
SPARK PLUG GAP	.023 to .027"	.023 to .027"
IGNITION	Solid State	Solid State
MODULE AIR GAP	.008 to .012"	.008 to .012"
CHAIN	3/8" Pitch—Chisel Type	3/8" Pitch—Chisel Type
MUFFLER	Spark Arresting	Spark Arresting
FUEL MIX	(16:1) ½ pint oil to 1 Gal. Reg. Gasoline	(16:1) ½ pint oil to 1 Gal. Reg. Gasoline
OILER	Automatic/Manual	Automatic/Manual

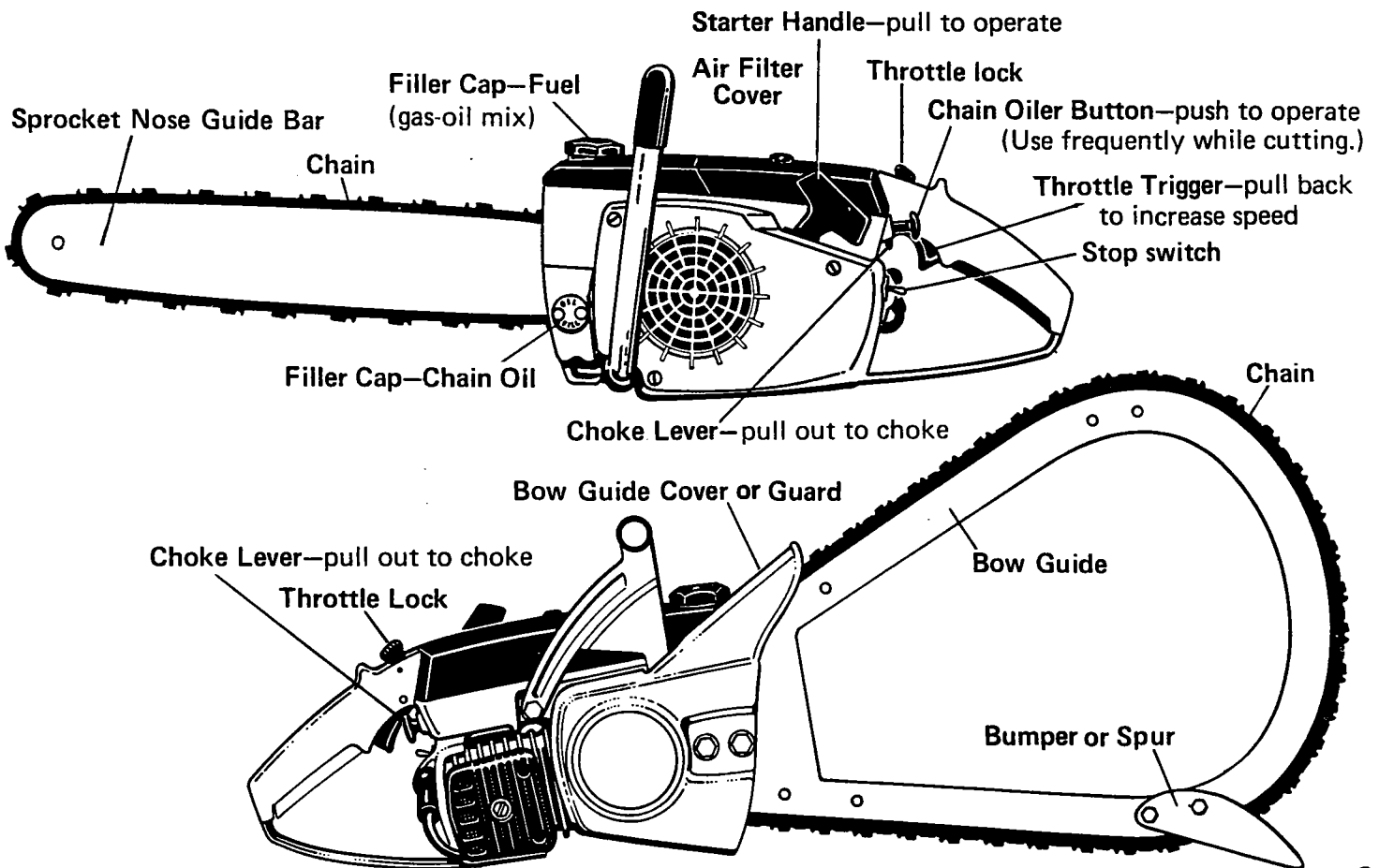

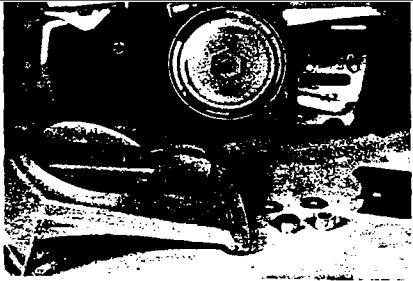

Figure 1



Figure 2

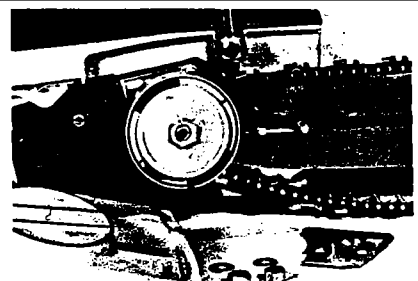

Figure 3

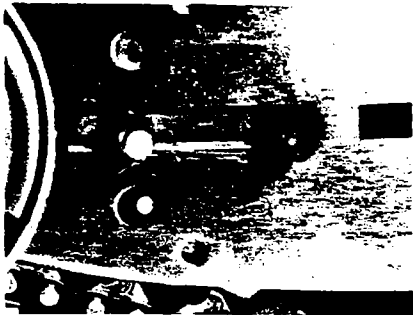

Figure 4

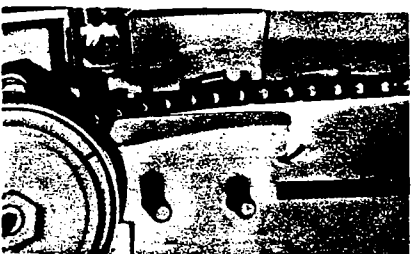

Figure 5



Figure 6

1. Remove the bar mounting nuts, washers, bar clamp and outer guide bar plate. (Note position of the plate.) Figure 1
2. Mount the slotted end of the bar over the bar mounting studs and slide bar rearward as far as possible. Figure 2
3. Place the chain over the sprocket and engage the drive link tangs between sprocket teeth. Figure 3
4. Starting at the top of the bar, gradually work the chain into the groove of the bar until all the drive links are engaged in the bar groove. Make sure the cutting edges of the chain face forward as shown in Figure 5.
5. Turn (counter-clockwise) the bar adjusting screw (see chain adjustment photo Figure 6) until adjusting pin in Figure 4 is in extreme rear position. Pull bar forward until adjusting pin seats in the hole of the bar.
6. Replace outer guide bar plate. (Note position). Replace bar clamp, washers and nuts on the bar mounting studs and tighten nuts finger tight. Figure 5

CHAIN ADJUSTMENT (Figure 6)

Raise tip of bar and turn the bar adjusting screw (clockwise) until the bottom of all tie straps and cutters of the chain make contact with the bottom rails of the guide bar. There should be no droop or slack in the chain. Chain should move around guide bar freely, when pulled by hand. Continue to hold the tip of the bar and tighten the bar mounting nuts securely, with the bar wrench.

Run engine slowly for a minute or two while keeping the chain well oiled. Stop engine and check chain tension and readjust if necessary. Check chain tension

(continued on Page 5)

BOW INSTALLATION

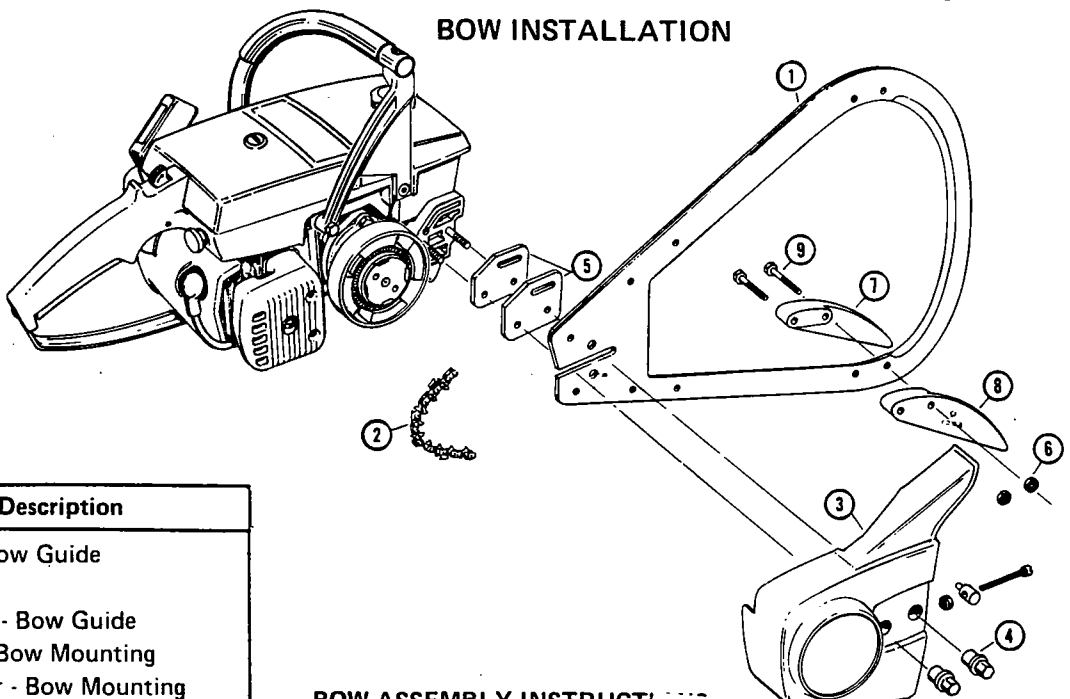

BOW ASSEMBLY INSTRUCTIONS

1. Install two 23447 spacers on top and to the right.
2. Attach 1207 and 1208 bumpers to bow guide with 625567 screws and two 1615 locknuts.
3. Mount bow guide, chain and 11176 cover on saw while making sure that adjusting pin enters hole in bow guide.
4. Install 22087 nuts finger tight, adjust chain tension and tighten nuts.

Ref. No.	Part No.	Qty.	Description
1	4484	1	13" Bow Guide
2	51654	1	Chain
3	11176	1	Cover - Bow Guide
4	22087	2	Nut - Bow Mounting
5	23447	2	Spacer - Bow Mounting
6	1615	3	Nut - Adapter & Bumper Mounting (1/4-20 flexloc)
7	1207	1	Bumper - (left)
8	1208	1	Bumper - (right)
9	625567	2	Screw - Bumper Mounting (1/4-20 x 1-1/2 hex head)

loosely or too tightly will cause excessive wear to guide bar and chain. It is important that you keep the chain sharp and properly filed at all times. (See Chain Filing Instructions).

NOTE: Saws equipped with sprocket nose bar, grease the sprocket nose at least once every hour of cutting using a hand grease gun which is available from your authorized service dealer.

OPERATING INSTRUCTIONS

Before Starting

- Check the chain tension. Is the chain sharp?
- Are the handles clean of gas and oil?
- Did you fill the fuel AND oil tanks?

FUEL and OIL

Fuel Mix: 16 parts gasoline to 1 part oil (1/2 pint oil to one gallon gasoline). Use air cooled two cycle engine oil for fuel mix.

CAUTION:

When preparing fuel mixture, mix only the amount needed for the job you are to do. **Do not** use fuel mixture that has been stored longer than **two (2) months**. Fuel mixture stored longer than this will cause hard starting and poor performance of your saw. If fuel mix has been stored in your saw longer than this time it should also be removed and filled with a fresh mixture before using.

Chain Oil: Use chain oil or CLEAN SAE 30 oil. Thin slightly (10:1) with kerosene for very cold weather (Below 30°F). **FILL THE OIL TANK EACH TIME YOU FILL THE FUEL TANK.**

A WORD ABOUT CHAIN OILING

1. Fill the oil tank each time you fill the fuel tank. Lack of oil on the chain will quickly ruin the bar and chain.
2. You will use at least 1/3 tank of oil for each tank of gas. If you use less, check for a plugged oil hole in the guide bar.

Use clean oil. Do not let sawdust or dirt into the oil tank. Clean the oil cap and the area around it before removing. **A little oil will pump out after the engine stops. Oil on the bar and chain will drip off after use. Let the saw stand and cool off. Wipe the bottom clean before storing.**

STARTING

Move bystanders and obstructions well out of reach! Release the trigger after the engine starts.

WARNING: Chain will be moving when engine starts. Make sure Chain is not touching anything before starting.

1. Pull Choke Knob out.
2. Move ON/OFF Switch to ON position.
3. Open throttle by squeezing Trigger and depress Throttle Latch located on top of pistol grip.
4. Release Trigger but keep Throttle Latch depressed completely. This will open throttle slightly for easier starting.
5. Set saw on ground and place right foot in lower part of pistol grip.
6. Kneel on left knee, grasp Handle Bar with left hand and Starter Handle with right hand.
7. Holding saw firmly, pull briskly on Starter Rope Handle until engine fires. (A single "pop" is sufficient).
8. After engine fires, push Choke Knob in and engine should run on next few pulls.
9. After engine starts and runs a few seconds, give Throttle Trigger a light squeeze and Throttle Latch will release automatically, allowing engine to idle.

gine flood, repeat starting instructions with Choke Knob pushed in until engine starts.

10. To stop engine flip ON/OFF Switch to OFF position.

CUTTING TIPS

▼ Read the safety tips in the front of this manual. Always keep your chain sharp.

Plan Ahead

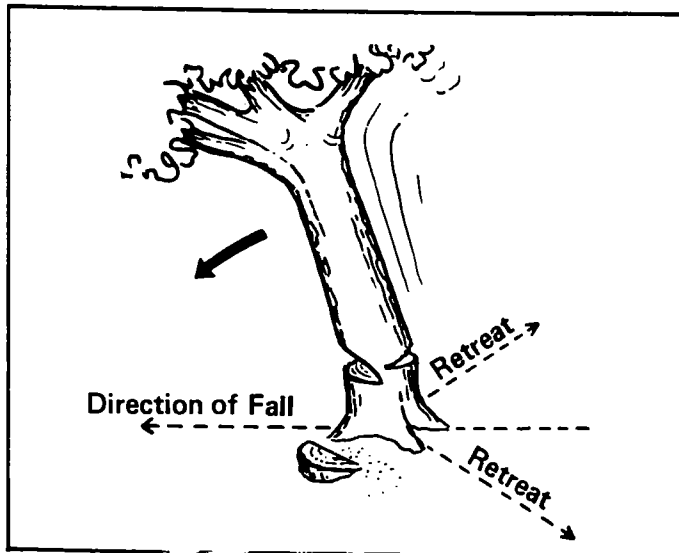

Check The Wind – If it is strong enough to move the top of the tree, **DON'T CUT!** Come back another day!

Check The Lean – Tie a weight to a piece of string about 3 feet long. Hang the weight in your line of sight. The string is a good vertical line to help you judge the lean of the tree. The tree will try to fall the way it is leaning.

Check The Weight Distribution – A tree is heavier on the side with the most limbs. It will try to fall on its heavy side. Trim a few limbs to "balance" the tree.

Clear The Work Area – You need a clean area all around the tree for good footing. Get everything out of the area where the tree will fall. People, pets, cars, etc.

Find a Retreat Path – Know which way you are going when the tree starts to fall. Make sure it is clear.

BOW CUTTING TIPS

WARNING! Kickback may cause serious injury. Read all instructions carefully before using the bow guide.

A BOW IS NOT

1. It is not for use by inexperienced cutters.
2. It is not for limbing trees.
3. It is not for pruning trees.
4. It is not for clearing brush.

A BOW IS

1. It is a tool for use by professionals only!
2. It is used for bucking a fallen, limbed tree into shorter lengths.
3. It can be used, with proper instruction, for felling trees.

BE CAREFUL

1. **DO NOT OPERATE WITHOUT THE SPUR AND CHAIN GUARD PROPERLY ATTACHED.** (continued)

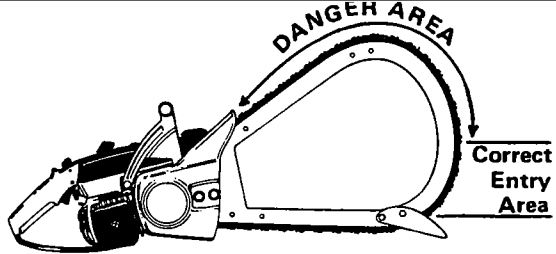

Always begin cutting in the correct entry area of the bow.

2. Be sure the spur is in place against the log before beginning the cut.
3. Do not cut small limbs or brush with a bow.

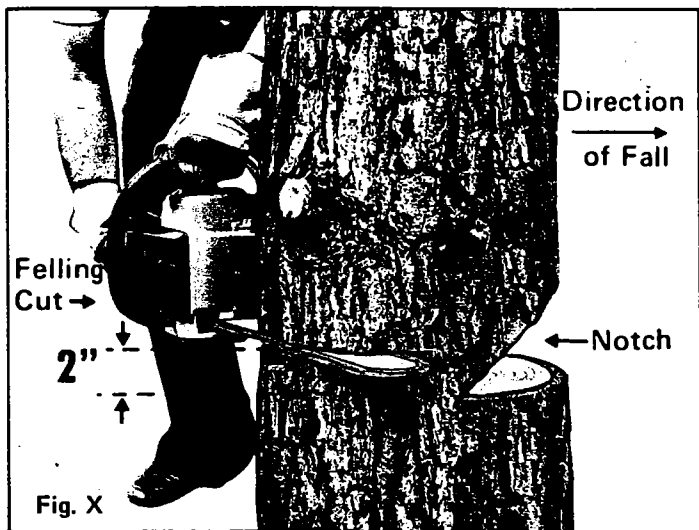

Fig. X

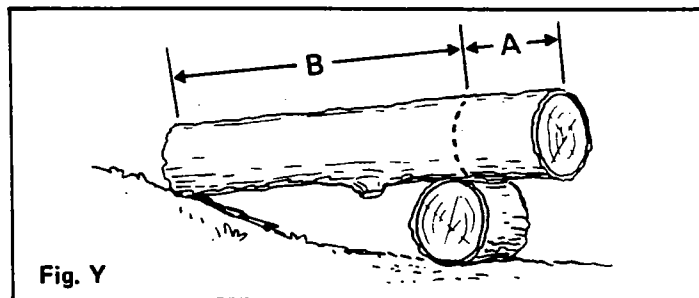
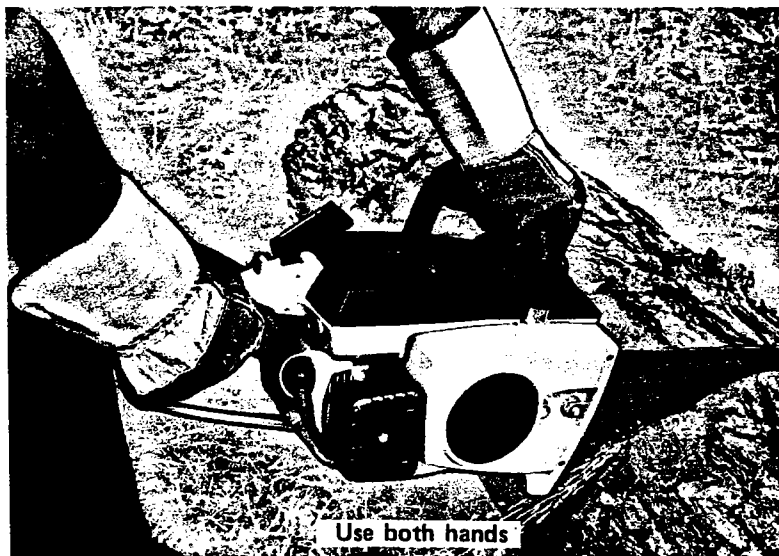

Fig. Y



Use both hands

5. Keep the chain tight and sharp.

LOOK OUT FOR KICKBACK

1. When the bow contacts an object in the danger area, the bow is thrown upward with considerable force. **THIS IS KICKBACK!**
2. Hold the saw firmly with both hands.
3. Don't over reach.
4. Cut only at high engine speeds.
5. **DO NOT REACH ABOVE WAIST HIGH. THE BOW IS TOO CLOSE TO YOUR FACE IN THIS POSITION.**
6. Keep your chain sharp. A dull chain kicks back harder than a sharp chain.

FELLING (Cutting down a tree)

A Small Trees – Less than 8" across

1. If there is doubt about the direction of fall, use "notch" method described in B.
2. Make a single felling cut on the side away from the direction of fall. Don't cut all the way through!
3. When the tree starts to fall, turn saw off, put the saw down and **GET AWAY QUICKLY!**

B Large Trees – 8" or larger across (Fig. X)

1. The notch is very important. The tree will try to fall "into" the notch.
2. Make the bottom notch cut first, about 1/3 to 1/2 way into the tree.
3. Complete the notch with the slant cut. Remove the wedge of wood before going on.
4. The felling cut is next. Make it on the side opposite the notch.
5. It is made 2" higher than the bottom of the notch.
6. **DO NOT** try to cut through to the notch.
7. As the tree starts to fall, turn saw off, put the saw down and **GET AWAY QUICKLY!**

BUCKING

Bucking is the sawing of a log or fallen tree into smaller pieces.

- Use Both Hands – grip the saw firmly with the thumb and forefinger wrapped around the handle.
- Stand Uphill – a log that is cut loose will roll downhill.



Keep the tree between you and the chain

- Stand to the left of the saw.

How To (Fig. Y)

- A In area "A", come up from the bottom 1/3 of the way. Finish by coming down from the top.
- B In area "B", come down from the top 1/3 of the way. Finish by coming up from the bottom.

PRUNING AND DEBRANCHING

1 Be Careful

- Use Both Hands — keep a firm grip.
- Look Out For Kickback — don't let the tip of the bar touch anything while the engine is running.
- Don't Cut Overhead — keep the saw below chest high. The

2 Pruning (Cutting limbs from standing tree)

- Don't Use The Saw In A Tree — It is very dangerous. Get professional help.
- Keep Both Hands On The Saw — keep a firm grip.
- Be Sure Of Your Support — don't cut off balance.
- Cut Up From The Bottom, Finish Down From The Top.

3 Debranching (Cutting the limbs from a fallen tree)

- Cut On The Opposite Side Of The Tree — keep the tree between you and the chain.
- Be Sure Of Your Footing — work slowly and deliberately.
- Look Out For Springpoles — limbs bent under pressure will snap up at you when cut.

CARE AND MAINTENANCE FOR YOUR SAW

Follow these helpful hints on care and maintenance to get the best possible service from your saw, to prevent major breakdown and costly repair bills. Careful servicing of your saw is one of the most important steps in preventative maintenance. Should your saw develop trouble that you are not prepared to handle, take it to an authorized Service Dealer for service. He has been trained and is equipped to provide expert service work.

CLEANING: Protect your investment. Keep your saw clean and free of saw dust, dirt, etc. Clean cylinder fins regularly.

HANDLING: Your saw is a precision built tool. Do not abuse it by rough handling. Do not leave it out in the weather, unprotected. When transporting your saw by truck or car, make certain that it is secured in place so as not to be tossed around.

INSPECTION: After each use, check your saw for loose nuts and screws and worn parts. Have your authorized service dealer replace worn parts. Make certain that chain is kept sharp. If you have any questions regarding the operational condition of your saw, have your authorized service dealer examine it.

SPARK PLUG: Remove spark plug and clean. If plug is fouled, replace with a new one. Measure the gap with a wire gauge. Gap should be set at .025 inch.

AIR FILTER: The air filter is located under the air filter cover just behind the gas tank. Remove and lift out air filter. Clean the air filter by sloshing it around in clean gasoline or a cleaning solvent. Allow filter to dry and then replace.



Clean the air filter after every 10 tanks of gas or every 5 hours of operation.

Caution: Never operate your saw without the air filter in place as dirt and dust in the air can be sucked up through the carburetor and into the combustion chamber causing excessive wear to piston rings and cylinder wall. Always keep an extra air filter on hand.

FUEL PICK-UP FILTER: The fuel pickup filter is located inside the gas tank at the end of the fuel pickup line. Should the filter become loaded with dirt or water logged, it will not filter the fuel properly and should be replaced. To replace the pick-

up filter, remove the gas tank cover to expose the gas pickup line and filter. Remove old filter and replace with new one.

Caution: Never operate your saw without the fuel pickup filter in place.

CYLINDER FINS: It is important that the cylinder fins be kept clean to insure proper cooling and a good flow of air over the cylinder. If cylinder fins are not cleaned, intense heat will build up in the engine and cause severe damage to it. To clean cylinder fins, remove fan housing and use compressed air to blow away the dirt, sawdust, etc. from between the fins. If compressed air is not available, use a small brush soaked in a cleaning solvent or gasoline. Fig. 8

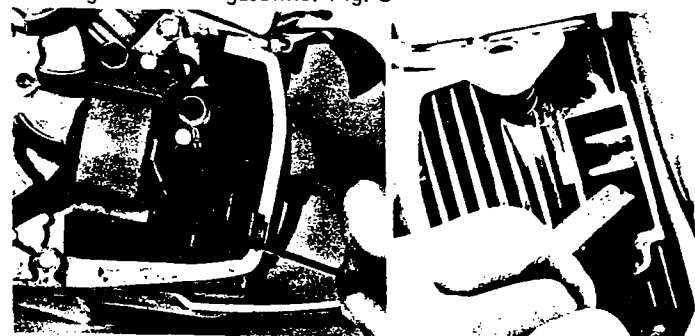

Figure 8

Figure 9

MUFFLER AND EXHAUST PORTS: Check for clogged openings in the muffer screen. To clean the muffer screen, remove the muffer baffle and two studs holding muffer body and screen. Clean screen with a wire brush. While muffer is off, check for clogged exhaust ports. Exhaust ports that are clogged with carbon will cause your engine to loose power. Make certain that ports are open. Fig. 9

To clean exhaust ports follow these directions:







1. Remove muffer assembly to expose exhaust ports.
2. Pull starter rope until piston completely covers the exhaust port openings.
3. Scrape the carbon from the exhaust ports until ports are completely open. Be extremely careful not to mar the piston. Use wooden scraper only.
4. Blow away the loosened carbon particles with compressed air. If compressed air is not available, turn saw on its side and shake out the particles.

STORING THE SAW

Once you have finished using the saw and it is to be idle for several months, follow these steps before storing the saw.

1. Drain fuel from fuel tank.
2. Start engine and allow to run at idle speed until all fuel is used.
3. Drain oil from oil reservoir.
4. Store in a dry area and cover to protect from dust.

BE CAREFUL! The chain will be moving during this procedure.

1. Stop the engine.
2. Turn the high speed and low speed mixture screws clockwise  until they stop. (Figure 10) Don't tighten them, you may damage the needle seats!
3. Turn the high speed and low speed mixture screws one full turn counterclockwise .
4. Start the engine. If it stops, increase the idle speed by turning the idle speed screw clockwise . (Figure 11)
5. Run the engine for a few minutes to bring it up to operating temperature.
6. Set the idle speed as fast as possible without the chain moving. Turn the idle speed screw clockwise  for faster idle, counterclockwise  for slower idle.
7. Squeeze the trigger quickly. If the engine stops, restart it. The engine should accelerate without hesitating when the trigger is squeezed. If it does not, turn the low speed mixture screw counterclockwise  1/16 of a turn and check the acceleration again. If the idle speed slows while adjusting the low speed mixture, reset the idle speed as in step 6. Continue step 7 until acceleration is smooth.
8. Make a test cut with the saw.
9. If the engine seems to smoke excessively in the cut, turn the high speed mixture screw clockwise  1/16 of a turn. Repeat step 8 and 9, if necessary. **WARNING:** The high speed needle must never be less than 7/8 turn open. Too lean of a setting will quickly ruin the engine.
10. If the engine seems to weaken or lose power in the cut,

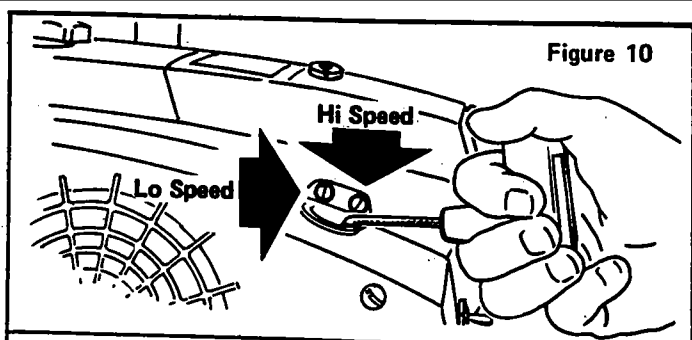

Figure 10

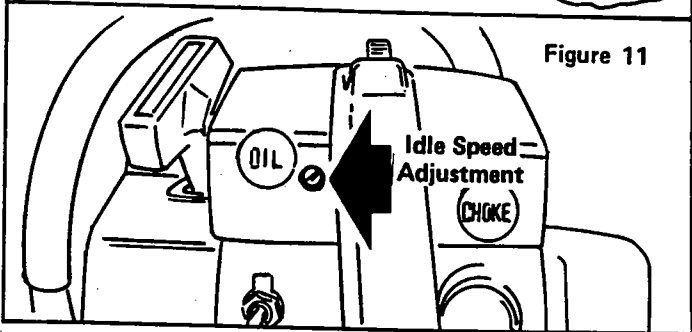



Figure 11

turn the high speed mixture screw counterclockwise  1/16 of a turn at a time until the saw cuts smoothly. The high speed mixture screw should not be open more than 1/4 turns (counterclockwise ) from the stopped position in step 2.

11. Reset the idle speed (see step 6).

CHAIN SHARPENING

A properly sharpened chain is the secret of effortless, trouble free cutting. Your authorized dealer or authorized master service center will be happy to answer your question on chain sharpening and supply whatever materials you need. To avoid any delay, while working, carry a spare sharp chain and do your sharpening after you have completed cutting.

FILING CHISEL CHAIN

To properly sharpen your chain, you will need a fileholder, the correct size file and jointer. Follow these instructions:

1. If possible, remove the chain from the saw and put it in a saw chain filing vise. If you do not have a filing vise, tension the chain up snugly on the guide bar.
2. There are three angles that must be maintained for a properly sharpened chain. These are: (a) 30° Top Plate Filing Angle, (b) 60° Top Plate Cutting Angle, (c) and 75° Side Plate Angle. All three angles can be maintained accurately by using a No. 55047 Fileholder and holding it in the right position.

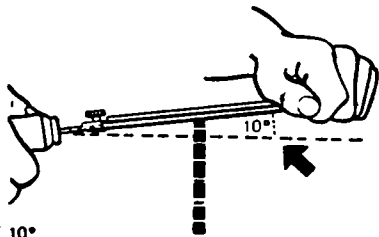
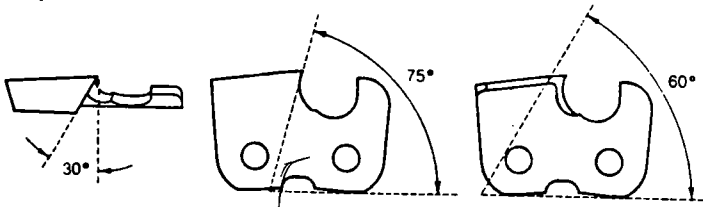

LOWER FILE HANDLE 10°

3. Using a 3/16" dia. file, press the flat side of the file holder firmly against the top of the cutters.

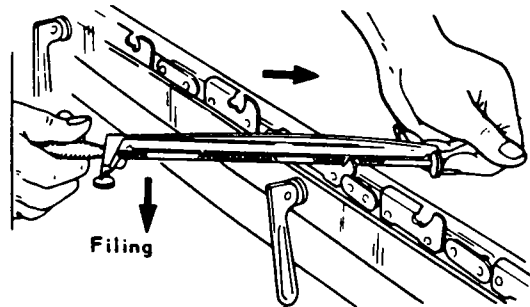

4. Lower fileholder handle down 10° below horizontal position.
5. Maintain 30° mark on file holder parallel to the chain.
6. Push the file through the cutter, from inside out while holding the holder in the position outlined above. Apply pressure on the forward stroke only.

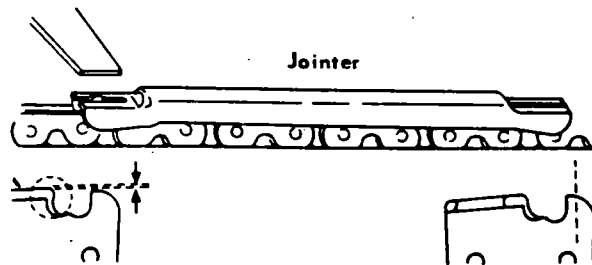

7. To set all depth gauges at the same level, place the jointer over each depth gauge and file the depth gauge with a flat file until it is level with the jointer, then round off the leading edge of each depth gauge.

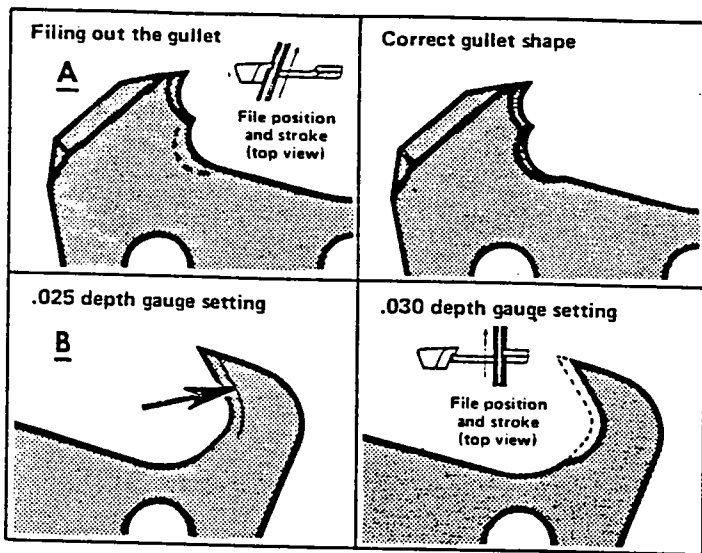

This chain was designed so that 80% of the needed sharpening is accomplished by the saw's built-in sharpener. While the chain is being sharpened by the built-in sharpener, the cutting edges of the chain are gradually being altered. These edges may also be damaged if you saw into rock, dirt, nails, or other foreign materials. In either case, it will be necessary to reshape the side cutting edge with a file.

To properly file the Power Sharp Chain you will need a fileholder and the correct size file. Follow these instructions:

1. If possible, remove the chain from the saw and put it in a saw chain filing vise. If you do not have a filing vise, tension the chain up snugly on the guide bar. Use a No. 5595 Fileholder and hold it level at a 24° angle to the chain. Always file from inside of chain toward the outside.
2. When cutters have been filed back to a point where the gullet (see fig. A) extends beyond the cutting edge by 1/16 inch, the gullet should be removed. Do this before your next cutting edge filing, using the same 7/32" file and maintaining the same 24° Top Plate Angle. The correct gullet shape will then be as shown.
3. The factory Depth Gauge settings are .025 inch. The mark on the depth gauge (see fig. B) is for setting of .030 inch. If you wish to use this setting, simply file off metal behind the mark with a round file as shown in figure B (see arrow).

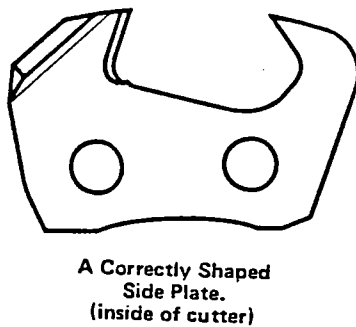

A Correctly Shaped Side Plate. (inside of cutter)

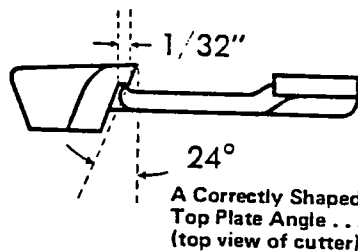

A Correctly Shaped Top Plate Angle ... (top view of cutter)

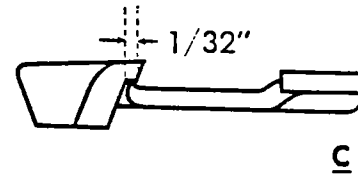

C

Remember: (a) Normal sharpening is accomplished by the built-in sharpener. (b) File cutters only when dull and attempt to keep all cutters the same length. The Side Plate should always be kept approx. 1/32" longer than the top plate (see fig. C). (c) Preserve the original filing angles carefully and uniformly. (d) Care should be taken never to file into the bottom of the Top Plate.

Free Manuals Download Website

<http://myh66.com>

<http://usermanuals.us>

<http://www.somanuals.com>

<http://www.4manuals.cc>

<http://www.manual-lib.com>

<http://www.404manual.com>

<http://www.luxmanual.com>

<http://aubethermostatmanual.com>

Golf course search by state

<http://golfingnear.com>

Email search by domain

<http://emailbydomain.com>

Auto manuals search

<http://auto.somanuals.com>

TV manuals search

<http://tv.somanuals.com>