

Poulan PRO®

ENGLISH



Please do not return product to retailer.
Por favor, no devuelva el producto al lugar de compra.
Veuillez ne pas retourner le produit au détaillant.

1-800-554-6723

Register your product online at:
Registre su producto en línea en:
Enregistrez votre produit en ligne à l'adresse :
www.poulanpro.com

Instruction Manual Manual de Instrucciones Manuel d'Instructions

PP133

ESPAÑOL

For Occasional Use Only



WARNING:

Read and follow all Safety Rules and Operating Instructions before using this product. Failure to do so can result in serious injury.

ADVERTENCIA:

Lea el manual de instrucciones y siga todas las advertencias e instrucciones de seguridad. El no hacerlo puede resultar en lesiones graves.

AVERTISSEMENT:

Lire le manuel d'instructions et bien respecter tous les avertissements et toutes les instructions de sécurité. Tout défaut de le faire pourrait entraîner des blessures graves.

Poulan PRO
7349 Statesville Road
Charlotte, NC 28269

Poulan PRO
850 Matheson Blvd. West
Mississauga, Ontario L5V 0B4

FRANÇAIS

115249526 Rev. 3 4/22/10 BRW

TABLE OF CONTENTS

| | | | |
|----------------------------------|----|----------------------------|----|
| Identification of Safety Symbols | 2 | Service & Adjustments | 14 |
| Safety Rules | 4 | Storage | 15 |
| Assembly | 9 | Troubleshooting Table | 16 |
| Operation | 10 | Limited Warranty Statement | 16 |
| Maintenance | 13 | Emissions Statement | 17 |

IDENTIFICATION OF SAFETY SYMBOLS

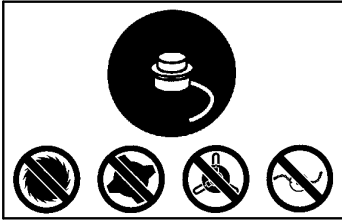

⚠ DANGER: Use only specified trimmer head, spool, and recommended trimmer line. Never use blades, flailing devices, wire, rope, string, etc. This attachment is designed for line trimmer use only. Failure to follow these instructions may result in serious injury.



⚠ WARNING: This unit can be dangerous! Careless or improper use can cause serious injury.



⚠ WARNING: Read the operator's manual before use. Failure to follow instructions could result in serious injury to the operator and/or bystanders. Save operator's manual.



Trimmer line can throw objects violently. You can be blinded or injured. Always wear hearing protection and safety glasses marked Z87. Always wear head protection, heavy, long pants, long sleeves, boots and gloves.

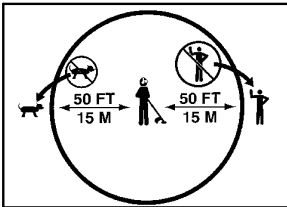

Hazard zone for thrown objects.

- Trimmer line throws objects violently.
- You and others can be blinded/injured.
- Keep children, bystanders, and animals 50 feet (15 meters) away. Bystanders should be encouraged to wear safety glasses.



Secure hair above shoulder length. Do not wear jewelry, loose clothing, or clothing with loosely hanging straps, ties, tassels, etc. They can be caught in moving parts.

IDENTIFICATION OF SAFETY SYMBOLS

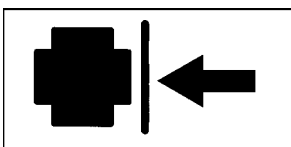

Assist handle to be positioned only below the arrow.

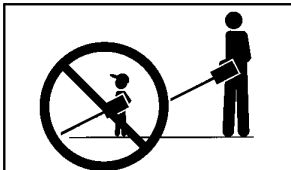

Never allow children to operate this unit.



Store unit indoors in a high, dry place out of the reach of children.



When servicing unit, use only identical replacement parts.

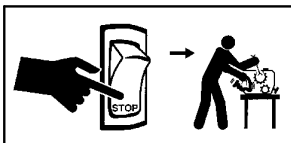

Always stop unit and disconnect spark plug before cleaning or servicing.



WARNING: Fire hazard. Never mix, pour, or store gasoline or use the unit near a flame or sparks (including smoking, open flames, or work that can cause sparks).

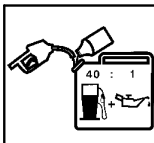

Use unleaded gasoline and two-stroke oil mixed at a ratio of 40:1 (2.5%).

OPTIONAL ATTACHMENTS

These attachments used in combination with the specified powerhead have been evaluated to ANSI B175.3-2003, "Grass Trimmers and Brushcutters - Safety Requirements". These combinations have been evaluated by Underwriter's Laboratories Inc. (UL) and are consequently UL listed:

| Powerhead model | Attachments | Type | Cutting attachment / guard, part. no. |
|-----------------|------------------------|---------------|---------------------------------------|
| PP133 | Trimmer head | WE fixed line | 545053902 / 545003325 |
| | Brushcutter attachment | PP4000C | 952711610 |

These attachments used in combination with the specified powerhead have been evaluated to applicable ISO- and EN safety requirement standards by the Swedish Machinery Testing Institute.

| Attachments | Type | Part. no. |
|-----------------------|---------|-----------|
| Edger attachment | PP1000E | 952711607 |
| Cultivator attachment | PP2000T | 952711608 |
| Blower attachment | PP3000B | 952711609 |
| Pruner attachment | PP5000P | 952711612 |
| Pruner attachment | PP5500P | 952711672 |

SAFETY RULES

WARNING: When using gardening appliances, basic safety precautions must always be followed to reduce the risk of fire and serious injury. Read and follow all instructions. *This power unit can be dangerous!* Operator is responsible for following instructions and warnings on unit and in manual. Read entire instruction manual before using unit! Be thoroughly familiar with the controls and the proper use of the unit. Restrict the use of this unit to persons who have read, understand, and will follow the instructions and warnings on the unit and in the manual. Never allow children to operate this unit.



INSTRUCTION
MANUAL



SAFETY INFORMATION
ON THE UNIT

DANGER: Never use blades with line trimmer attachment. Never use flailing devices with any attachment. This unit (when used with supplied line trimmer attachment) is designed for line trimmer use only. Use of any other accessories or attachments with line trimmer attachment will increase the risk of injury. If situations occur which are not covered in this manual, use care and good judgment. If you need assistance, contact your authorized service dealer or call 1-800-554-6723.

OPERATOR SAFETY

• Dress properly. Always wear safety glasses or similar eye protection when operating, or performing maintenance, on your unit (safety glasses are available). Eye protection should be marked Z87.

- Always wear face or dust mask if operation is dusty.
- Always wear heavy, long pants, long sleeves, boots, and gloves. Wearing safety leg guards is recommended.
- Always wear foot protection. Do not go barefoot or wear sandals. Stay clear of spinning line.
- Secure hair above shoulder length. Secure or remove loose clothing or clothing with loosely hanging ties, straps, tassels, etc. They can be caught in moving parts.
- Being fully covered also helps protect you from debris and pieces of toxic plants thrown by spinning line.
- Stay Alert. Do not operate this unit when you are tired, ill, upset or under the influence of alcohol, drugs, or medication. Watch what you are doing; use common sense.
- Wear hearing protection.
- Never start or run inside a closed room or building. Breathing exhaust fumes can kill. Keep handles free of oil and fuel.
- Keep handles free of oil and fuel.
- Always keep engine on the right hand side of your body.
- Hold the unit firmly with both hands. Keep trimmer head (or other optional attachment) below waist level and away from all parts of your body. Do not raise engine above your waist.
- Keep all parts of your body away from muffler and spinning line (or other optional attachment). Keep engine below waist level. A hot muffler can cause serious burns.
- Keep firm footing and balance. Do not overreach or use from unstable surfaces such as ladders, trees, steep slopes, rooftops, etc.

- Use only in daylight or good artificial light.
- Use only for jobs explained in this manual (or manuals for optional attachments).

UNIT / MAINTENANCE SAFETY

- Disconnect the spark plug before performing maintenance except carburetor adjustments.
- Look for and replace damaged or loose parts before each use. Look for and repair fuel leaks before use. Keep in good working condition.
- Replace trimmer head parts that are chipped, cracked, broken, or damaged in any other way before using the unit.
- Maintain unit according to recommended procedures. Keep cutting line at proper length.
- Use only 0.115 inch (3 mm) diameter Poulan PRO brand line. Never use wire, rope, string, etc.
- Install required shield properly before using the unit. Use only specified trimmer head; make sure it is properly installed and securely fastened.
- Make sure unit is assembled correctly as shown in this manual.
- Make carburetor adjustments with lower end supported to prevent line from contacting any object.
- Keep others away when making carburetor adjustments.
- Use only recommended Poulan PRO accessories and replacement parts.
- Have all maintenance and service not explained in this manual performed by an authorized service dealer.

FUEL SAFETY

- Mix and pour fuel outdoors.
- Keep away from sparks or flames.
- Use a container approved for fuel.
- Do not smoke or allow smoking near fuel or the unit.
- Avoid spilling fuel or oil. Wipe up all fuel spills.
- Move at least 10 feet (3 meters) away from fueling site before starting engine.
- Stop engine and allow to cool before removing fuel cap.
- Always store gasoline in a container approved for flammable liquids.

TRANSPORTING AND STORAGE

- Allow engine to cool; secure unit before storing or transporting in vehicle.
- Empty the fuel tank before storing or transporting the unit. Use up fuel left in the carburetor by starting the engine and letting it run until it stops.
- Store unit and fuel in area where fuel vapors cannot reach sparks or open flames from water heaters, electric motors or switches, furnaces, etc.
- Store unit so line limiter blade cannot accidentally cause injury. The unit can be hung by the shaft.
- Store unit out of reach of children.

⚠ WARNING: The engine exhaust from this product contains chemicals known to the State of California to cause cancer, birth defects or other reproductive harm.

SAFETY NOTICE: Exposure to vibrations through prolonged use of gasoline powered hand tools could cause blood vessel or nerve damage in the fingers, hands, and joints of people prone to circulation disorders or abnormal swellings. Prolonged use in cold weather has been linked to blood vessel damage in otherwise healthy people. If symptoms occur such as numbness, pain, loss of strength, change in skin color or texture, or loss of feeling in the fingers, hands, or joints, discontinue the use of this tool and seek medical attention. An anti-vibration system does not guarantee the avoidance of these problems. Users who operate power tools on a continual and regular basis must monitor closely their physical condition and the condition of this tool.

SPECIAL NOTICE: This unit is equipped with a temperature limiting muffler and spark arresting screen which meets the requirements of California Codes 4442 and 4443. All U.S. forest land and the states of California, Idaho, Maine, Minnesota, New Jersey, Oregon, and Washington require by law that many internal combustion engines be equipped with a spark arresting screen. If you operate in a locale where such regulations exist, you are legally responsible for maintaining the operating condition of these parts. Failure to do so is a violation of the law. For normal homeowner use, the muffler and spark arresting screen will not require any service. After 50 hours of use, we recommend that your muffler be serviced or replaced by your authorized service dealer.

LINE TRIMMER SAFETY

⚠ WARNING: Inspect the area before each use. Remove objects (rocks, broken glass, nails, wire, etc.) which can be thrown by or become entangled in line. Hard objects can damage the trimmer head and be thrown causing serious injury.

- Keep others including children, animals, bystanders, and helpers at least 50 feet (15 meters) away. Bystanders should be encouraged to wear safety glasses. Stop engine immediately if you are approached.
- Use only for trimming, scalping, mowing and sweeping. Do not use for edging, pruning or hedge trimming.
- Cut from your left to your right. Cutting on right side of the shield will throw debris away from the operator.

ADDITIONAL SAFETY RULES FOR OPTIONAL ATTACHMENTS

⚠ WARNING: For each optional attachment used, read entire instruction manual before use and follow all warnings and instructions in manual and on attachment.

⚠ WARNING: Ensure handlebar is installed when using brushcutter attachments. Attach handlebar above arrow on safety label on the upper shaft (engine end of unit). If your brushcutter attachment does not include a handlebar, a handlebar accessory kit (#530071451) is available from your authorized service dealer.

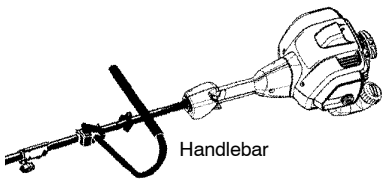

EDGER SAFETY

⚠ WARNING: Inspect the area to be edged before each use. Remove objects (rocks, broken glass, nails, wire, etc.) which can be thrown by the blade or can wrap around the shaft.

⚠ WARNING: Blade rotates momentarily after the trigger is released or engine is turned off. The blade can seriously cut you or others. Allow blade to stop before removing it from the cut.

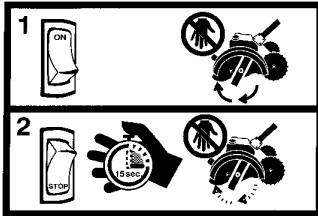

- Throw away blades that are bent, warped, cracked, broken or damaged in any other way. Replace parts that are cracked, chipped, or damaged before using the unit.
- Do not attempt to remove cut material nor hold material to be cut when the engine is running or when cutting blade is moving.
- Always keep the wheel and depth adjusting skid in contact with the ground.
- Always push the unit slowly over the ground. Stay alert for uneven sidewalks, holes in the terrain, large roots, etc.

BLOWER/VACUUM SAFETY

⚠ WARNING: Inspect area before starting unit. Remove all debris and hard objects such as rocks, glass, wire, etc. that can ricochet, be thrown, or otherwise cause injury or damage during operation.

- Do not set unit on any surface except a clean, hard area while engine is running. Debris such as gravel, sand, dust, grass, etc., could be picked up by the air intake and thrown out through discharge opening, damaging unit, property, or causing serious injury to bystanders or operator.
- Never place objects inside the blower tubes, vacuum tubes or blower outlet. Always direct the blowing debris away from people, animals, glass, and solid objects such as trees, automobiles, walls, etc. The force of air can cause rocks, dirt, or sticks to be thrown or to ricochet which can hurt people or animals, break glass, or cause other damage.

- Never run unit without the proper equipment attached. When using your unit as a blower, always install blower tubes.
- Check air intake opening, blower tubes or vacuum tubes frequently, always with engine stopped and spark plug disconnected. Keep vents and discharge tubes free of debris which can accumulate and restrict proper air flow.
- Never place any object in air intake opening as this could restrict proper air flow and cause damage to the unit.
- Never use for spreading chemicals, fertilizers, or other substances which may contain toxic materials.
- To avoid spreading fire, do not use near leaf or brush fires, fireplaces, barbecue pits, ashtrays, etc.

BRUSHCUTTER SAFETY

⚠ DANGER: Blade can thrust violently away from material it does not cut. Blade thrust can cause amputation of arms or legs.



⚠ WARNING: Do not use trimmer head as a fastening device for the blade.



⚠ WARNING: The blade continues to spin after the trigger is released or engine is turned off. The coasting blade can throw objects or seriously cut you if accidentally touched. Stop the blade by contacting the left hand side of the coasting blade with material already cut.

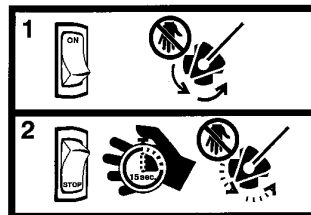

⚠ WARNING: Inspect the area to be cut before each use. Remove objects (rocks, broken glass, nails, wire, etc.) which can be thrown or become entangled in the blade or trimmer line.

- Throw away and replace blades that are bent, warped, cracked, broken or damaged in any other way.

- Install required shield properly before using the unit. Use the metal shield for all metal blade use. Only use brushcutter attachments that provide a metal shield with proboscis nose.

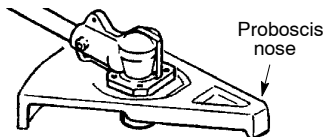

- Use only specified blade and make sure it is properly installed and securely fastened.
- Cut from your right to your left.
- Always use the handlebar and a properly adjusted shoulder strap with blade (see ASSEMBLY instructions in brushcutter attachment instruction manual).

CULTIVATOR SAFETY

⚠ WARNING: Rotating tines can cause serious injury. Keep away from rotating tines. Stop the engine and disconnect the spark plug before unclogging tines or making repairs.



- ⚠ WARNING:** Inspect the area to be cultivated before starting the unit. Remove all debris and hard and sharp objects such as rocks, vines, branches, rope, string, etc.
- Avoid heavy contact with solid objects that might stop the tines. If heavy contact occurs, stop the engine and inspect the unit for damage.
 - Never operate the cultivator without the tine cover in place and properly secured.
 - Keep the tines and guard clear of debris.
 - After striking a foreign object, stop the engine, disconnect the spark plug and inspect the cultivator for damage. Repair before restarting.
 - Disconnect attachment from the drive engine before cleaning the tines with a hose and water to remove any build-up. Oil the tines to prevent rust.
 - Always wear gloves when servicing or cleaning the tines. The tines become very sharp from use.

- Do not run unit at high speed unless cultivating.

HEDGE TRIMMER SAFETY

⚠ DANGER: RISK OF CUT; KEEP HANDS AWAY FROM BLADE - Blade moves momentarily after the trigger is released or engine is turned off. Do not attempt to clear away cut material when the blade is in motion. Make sure the switch is in the OFF position, the spark plug wire is disconnected, and the blade has stopped moving before removing jammed material from the cutting blade. Do not grab or hold the unit by the cutting blade.

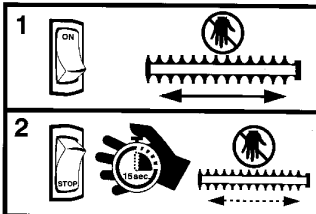

⚠ WARNING: Inspect the area before starting the unit. Remove all debris and hard objects such as rocks, glass, wire, etc. that can ricochet, be thrown, or otherwise cause injury or damage during operation.

- Do not use a cutting blade that is bent, warped, cracked, broken or damaged in any other way. Have worn or damaged parts replaced by an authorized service dealer.
- Always keep unit in front of your body. Keep all parts of your body away from the cutting blade.
- Keep the cutting blade and air vents clear of debris.

POLE PRUNER SAFETY

⚠ WARNING: The reciprocating blade/rotating chain can cause severe injury. Inspect the unit before use. Do not operate unit with a bent, cracked or dull blade or dull chain. Keep away from the blade/chain.

⚠ WARNING: The reciprocating blade/rotating chain is sharp. Do not touch. To prevent serious injury, always stop engine and ensure blade/chain has stopped moving, disconnect spark plug, and wear gloves when changing or handling the blade or chain.

⚠ WARNING: A coasting blade/rotating chain can cause injury while it continues to move after the engine is stopped. Maintain proper control of the unit until the blade/chain has completely stopped moving. Keep hands, face and feet at a distance from all moving parts. Do not attempt to touch or stop the blade or chain when it is moving.



WARNING: Falling objects can cause severe head injury. Wear head protection when operating this unit with a pole pruner attachment.



WARNING: To prevent serious injury, do not use more than one boom extension with a pole pruner attachment.

- WARNING:** Keep the pruner away from power lines or electrical wires.
- Only use for pruning limbs or branches overhead up to 4 inches (10 cm) in diameter.
 - Do not operate the unit faster than the speed needed to prune. Do not run the unit at high speed when not pruning.
 - Always stop the unit when work is delayed or when walking from one cutting location to another.
 - If you strike or become entangled with a foreign object, stop the engine immediately and check for damage. Have any damage repaired by an authorized service dealer before attempting further operations. Discard blades that are bent, warped, cracked or broken.
 - Stop the unit immediately if you feel excessive vibration. Vibration is a sign of trouble. Inspect thoroughly for loose nuts, bolts or damage before continuing. Contact an authorized service dealer for repair or replacement of affected parts as necessary.

SNOW THROWER SAFETY

WARNING: Keep hands and feet away from the rotor when starting or running the engine. Never attempt to clear the rotor with the engine/motor running. Stop engine and disconnect spark plug before unclogging snow or debris from discharge chute or when adjusting vanes.



WARNING: Never lean over discharge chute. Rocks or debris could be thrown into the eyes and face and cause serious injury or blindness.

WARNING: Inspect the area where the unit is to be used. Remove objects that could be thrown or damage the unit. Some objects may be hidden by fallen snow - be alert for the possibility.

- Direct material discharge away from glass enclosures, automobiles, etc.
- Do not run engine at high speed while not removing snow.
- Be attentive when using the snowthrower, and stay alert for holes in the terrain and other hidden hazards.
- Make sure the rotor will spin freely before attaching the snowthrower to the powerhead.
- If the rotor will not rotate freely due to frozen ice, thaw the unit before thoroughly before attempting to operate under power.
- Keep the rotor clear of debris.
- Do not throw snow near other people. The snow thrower could propel small objects at high speed causing injury.
- After striking a foreign object, stop the engine, disconnect spark plug and inspect the snowthrower for damage and repair if necessary before restarting unit.
- Never operate the snowthrower near glass enclosures, automobiles and trucks.
- Never attempt to use the snowthrower on a roof.
- Never operate the snowthrower near window wells, dropoffs, etc.
- Never discharge snow onto public roads or near moving traffic.
- Clear snow from slopes by going up and down; never across. Use caution when changing directions. Never clear snow from steep slopes.
- Let snowthrower run for a few minutes after clearing snow so moving parts do not freeze.
- Look behind and use care when backing up. Exercise caution to avoid slipping or falling, especially when operating in reverse.
- Know how to stop quickly.

ASSEMBLY

⚠ WARNING: If received assembled, repeat all steps to ensure your unit is properly assembled and all fasteners are secure. Examine parts for damage. Do not use damaged parts.

NOTE: If you need assistance or find parts missing or damaged, call 1-800-554-6723.

It is normal for the fuel filter to rattle in the empty fuel tank.

Finding fuel or oil residue on muffler is normal due to carburetor adjustments and testing done by the manufacturer.

INSTALLING TRIMMER ATTACHMENT

CAUTION: When installing trimmer attachment, place the unit on a flat surface for stability.

1. Loosen the coupler by turning the knob counterclockwise.

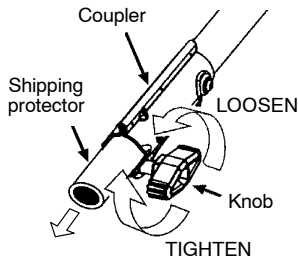

2. Remove shipping protector from coupler.
3. Remove the shaft cap from the trimmer attachment (if present).
4. Position locking/release button of attachment into guide recess of coupler.
5. Push the attachment into the coupler until the locking/release button snaps into the primary hole.
6. Before using the unit, tighten the knob securely by turning clockwise.

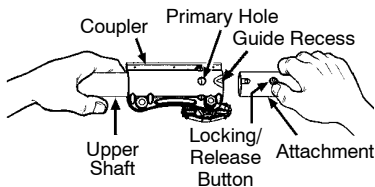

⚠ WARNING: Make sure the locking/release button is locked in the primary hole and the knob is securely tightened before operating the unit. All attachments are designed to be used in the primary hole unless otherwise stated in the applicable attachment instruction manual. Using the wrong hole could lead to serious injury or damage to the unit.

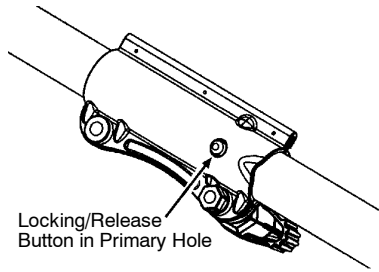

For assembly of optional attachments (see list on page 11), refer to the ASSEMBLY section of the applicable attachment instruction manual.

ATTACHING THE SHIELD

⚠ WARNING: The shield must be properly installed. The shield provides partial protection from the risk of thrown objects to the operator and others and is equipped with a line limiter blade which cuts excess line to the proper length. The line limiter blade (on underside of shield) is sharp and can cut you. For proper orientation of shield, see KNOW YOUR TRIMMER illustration in OPERATION section.

1. Remove wing nut from shield.
2. Insert bracket into slot as shown.
3. Pivot shield until bolt passes through hole in bracket.
4. Securely tighten wing nut onto bolt.

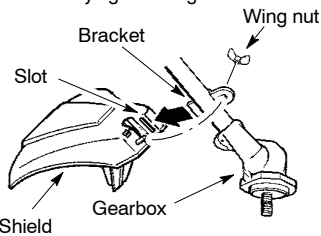

ADJUSTING THE HANDLE

⚠ WARNING: When adjusting the handle, be sure it remains above the safety label and below the mark or arrow on the shaft.

1. Loosen wing nut on handle.
2. Rotate the handle on the shaft to an upright position; retighten wing nut.

OPERATION

KNOW YOUR UNIT

READ THIS INSTRUCTION MANUAL AND SAFETY RULES BEFORE OPERATING YOUR UNIT. Compare the illustrations with your unit to familiarize yourself with the location of the various controls and adjustments. Save this manual for future reference.

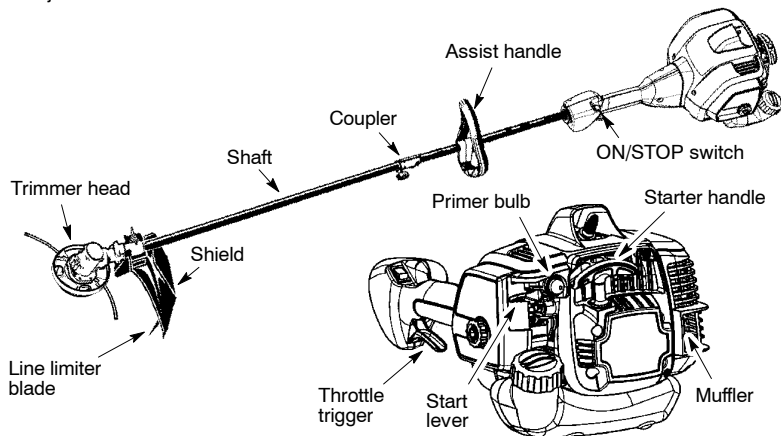

ON/STOP SWITCH

The ON/STOP switch is used to stop engine. To stop the engine, push and release the engine ON/STOP switch.

PRIMER BULB

The PRIMER BULB removes air from the carburetor and fuel lines and fills them with fuel. This allows you to start the engine with fewer pulls on the starter rope. Activate the primer bulb by pressing it and allowing it to return to its original form.

START LEVER

The START LEVER helps to supply fuel to the engine to aid in starting. Activate the starting system by moving the start lever to the START position. DO NOT squeeze the throttle trigger until the engine has started and runs. After the engine starts, allow the engine to warm-up 10-15 seconds, then fully squeeze the throttle trigger to deactivate the starting system (start lever returns to RUN position).

COUPLER

The COUPLER enables optional attachments to be installed on the unit.

BEFORE STARTING ENGINE

WARNING: Be sure to read the fuel information in the safety rules before you begin. If you do not understand the safety rules, do not attempt to fuel your unit. Call 1-800-554-6723.

FUELING ENGINE

WARNING: Remove fuel cap slowly when refueling.



HELPFUL TIP

To obtain the correct oil mix ratio, pour 3.2 ounces of 2-cycle synthetic oil into one gallon of fresh gas.

This engine is certified to operate on unleaded gasoline. Before operation, gasoline must be mixed with a good quality synthetic 2-cycle air-cooled engine oil designed to be mixed at a ratio of 40:1. Poulan/WEED EATER brand synthetic oil is recommended. Mix gasoline and oil at a ratio of 40:1. A 40:1 ratio is obtained by mixing 3.2

fluid ounces (95 ml) of oil with 1 gallon (4 liters) of unleaded gasoline. DO NOT USE automotive oil or marine oil. These oils will cause engine damage. When mixing fuel, follow instructions printed on container. Once oil is added to gasoline, shake container momentarily to assure that the fuel is thoroughly mixed. Always read and follow the safety rules relating to fuel before fueling your unit.

CAUTION: Never use straight gasoline in your unit. This will cause permanent engine damage and void the limited warranty.

FUEL REQUIREMENTS

This engine requires the use of minimum 87 octane [R+M]/2 clean gasoline.

IMPORTANT

Use of alcohol blended fuels (called gasohol or using ethanol or methanol) can cause major engine performance and durability problems.

WARNING: Alternative fuels (not gasoline) such as E-15 (15% alcohol), E-20 (20% alcohol), E-85 (85% alcohol) are NOT classified as gasoline and are NOT approved for use in

2-stroke gasoline engines. Use of alternative fuels will cause problems such as: improper clutch engagements, overheating, vapor lock, power loss, lubrication deficiency, deterioration of fuel lines, gaskets and internal carburetor components, etc. Alternative fuels cause high moisture absorption into the fuel/oil mixture leading to oil and fuel separation.

HOW TO STOP YOUR UNIT

- Release the throttle trigger.
- Push and release the engine ON/STOP switch. The switch will automatically return to the ON position. Wait 5 seconds before attempting to restart unit to allow switch to reset.

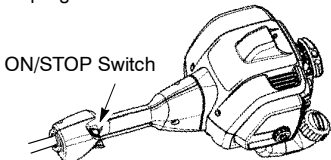

HOW TO START YOUR UNIT

WARNING: Avoid any contact with the muffler. A hot muffler can cause serious burns.



Starting position

HELPFUL TIP
 If your engine still does not start after installing these instructions, please call 1-800-554-6723.

STARTING A COLD ENGINE (or a warm engine after running out of fuel)

NOTE: DO NOT squeeze the throttle trigger until the engine has started and runs.

1. Set unit on a flat surface.
2. Slowly press the primer bulb 6 times.
3. Move the start lever to the START position.

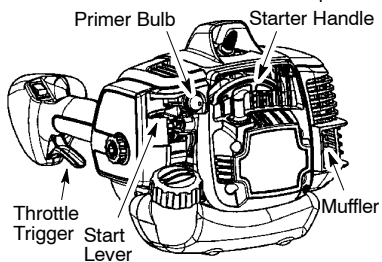

4. Pull starter rope handle sharply until engine starts and runs.
5. Allow unit to run for 10-15 seconds, then fully squeeze the throttle trigger to disengage the starting system.

STARTING A WARM ENGINE

Pull starter rope sharply until engine starts and runs.

NOTE: Normally, the warm starting procedure can be used within 5 - 10 minutes after the unit is turned STOP. If the unit sits for more than 10 minutes without being run, it will be necessary to start the unit by following the steps under STARTING A COLD ENGINE or following the starting instruction steps shown on the unit.

STARTING A FLOODED ENGINE

Move the start lever to the RUN position and fully squeeze throttle trigger. Pull the starter handle repeatedly while squeezing throttle trigger until engine starts and runs. This could require pulling the starter handle many times, depending on how badly the unit is flooded. If the unit still doesn't start, refer to TROUBLESHOOTING TABLE or call 1-800-554-6723.

OPERATING THE COUPLER

This model is equipped with a coupler which enables optional attachments to be installed. The optional attachments are:

| | |
|-------------|---------------|
| | MODEL: |
| Edger | PP1000E |
| Cultivator | PP2000T |
| Blower | PP3000B |
| Brushcutter | PP4000C |
| Pruner | PP5000P |
| Pruner | PP5500P |

WARNING: Always stop unit and disconnect spark plug before removing or installing attachments.

REMOVING TRIMMER ATTACHMENT (OR OTHER OPTIONAL ATTACHMENTS)

CAUTION: When removing or installing attachments, place the unit on a flat surface for stability.

1. Loosen the coupler by turning the knob counterclockwise.

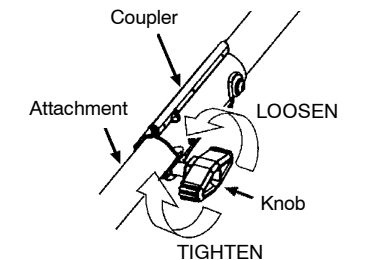

2. Press and hold the locking/release button.

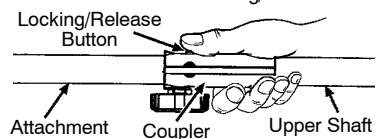

3. While securely holding the engine and upper shaft, pull the attachment straight out of the coupler.

INSTALLING OPTIONAL ATTACHMENTS

1. Remove the shaft cap from the attachment (if present).
2. Position locking/release button of attachment into guide recess of coupler.
3. Push the attachment into the coupler until the locking/release button snaps into the primary hole.
4. Before using the unit, tighten the knob securely by turning clockwise.

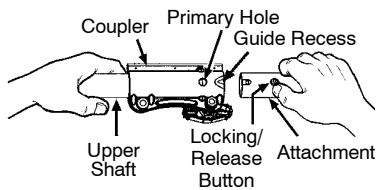

WARNING: Make sure the locking/release button is locked in the primary hole and the knob is securely tightened before operating the unit. All attachments are designed to be used in the primary hole unless otherwise stated in the applicable attachment instruction manual. Using the wrong hole could lead to serious injury or damage to the unit.

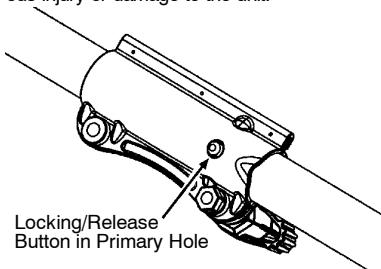

OPERATING INSTRUCTIONS

It is recommended that the engine not be operated for longer than 1 minute at full throttle.

OPERATING POSITION

ALWAYS WEAR:

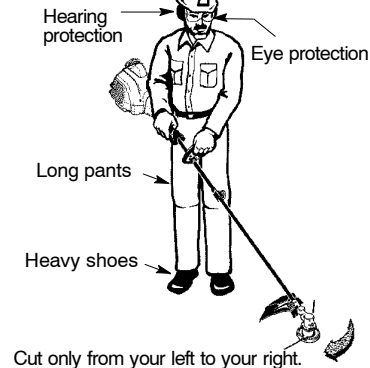

WARNING: Always wear eye protection. Never lean over the trimmer head. Rocks or debris can ricochet or be thrown into eyes and face and cause blindness or other serious injury.

When operating unit, stand as shown and check for the following:

- Wear eye protection and heavy clothing.
- Hold trigger handle with your right hand and assist handle with left hand.
- Keep unit below waist level.
- Cut only from your left to your right to ensure debris is thrown away from you. Without bending over, keep line near and parallel to the ground and not crowded into material being cut.

Do not run the engine at a higher speed than necessary. The cutting line will cut efficiently when the engine is run at less than full throttle. At lower speeds, there is less engine noise and vibration. The cutting line will last longer and will be less likely to "weld" onto the spool. Always release the throttle trigger and allow the engine to return to idle speed when not cutting.

To stop engine:

- Release the throttle trigger.
- Push and release the engine ON/STOP switch.

CUTTING METHODS

WARNING: Use minimum speed and do not crowd the line when cutting around hard objects (rock, gravel, fence posts, etc.), which can damage the trimmer head, become entangled in the line, or be thrown causing a serious hazard.

- The tip of the line does the cutting. You will achieve the best performance and minimum line wear by not crowding the line into the cutting area. The right and wrong ways are shown below.

Tip of the line does the cutting.



Right

Line crowded into work area.



Wrong

- The line will easily remove grass and weeds from around walls, fences, trees and flower beds, but it also can cut the tender bark of trees or shrubs and scar fences.
- For trimming or scalping, use less than full throttle to increase line life and decrease head wear, especially:
 - During light duty cutting.
 - Near objects around which the line can wrap such as small posts, trees or fence wire.
- For mowing or sweeping, use full throttle for a good clean job.

TRIMMING - Hold the bottom of the trimmer head about 3 inches (8 cm) above the ground and at an angle. Allow only the tip of the line to make contact. Do not force trimmer line into work area.

Trimming

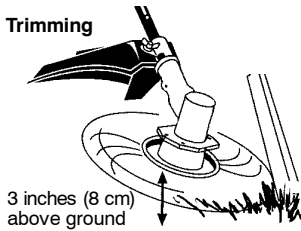

SCALPING - The scalping technique removes unwanted vegetation down to the ground. Hold the bottom of the trimmer head about 3 in. (8 cm) above the ground and at an angle. Allow the tip of the line to strike the ground around trees, posts, monuments, etc. This technique increases line wear.

Scalping

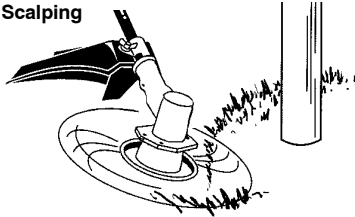

MOWING - Your trimmer is ideal for mowing in places conventional lawn mowers cannot reach. In the mowing position, keep the line parallel to the ground. Avoid pressing the head into the ground as this can scalp the ground and damage the tool.

Mowing

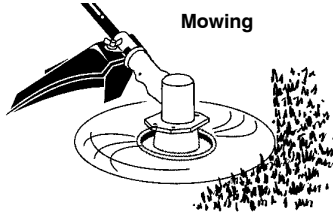

SWEEPING - The fanning action of the rotating line can be used to blow away loose debris from an area. Keep the line parallel to and above the area surface and swing the tool from side to side.

Sweeping



MAINTENANCE

WARNING: Disconnect the spark plug before performing maintenance except for carburetor adjustments.



HELPFUL TIP
IMPORTANT: Have all repairs other than the recommended maintenance described in the instruction manual performed by an authorized service dealer.
 If any dealer other than an authorized service dealer performs work on the product, Poulan PRO may not pay for repairs under warranty. It is your responsibility to maintain and perform general maintenance.

CHECK FOR LOOSE FASTENERS AND PARTS

- Spark Plug Boot
- Air Filter
- Housing Screws
- Assist Handle Screw
- Debris Shield

CHECK FOR DAMAGED OR WORN PARTS

Contact an authorized service dealer for replacement of damaged or worn parts.

- ON/STOP Switch - Ensure ON/STOP switch functions properly by pushing and releasing the switch. Make sure engine stops. Wait 5 seconds before attempting to restart unit to allow switch to reset. Restart engine and continue.
- Fuel Tank - Discontinue use of unit if fuel tank shows signs of damage or leaks.
- Debris Shield - Discontinue use of unit if debris shield is damaged.

INSPECT AND CLEAN UNIT AND DECALS

- After each use, inspect complete unit for loose or damaged parts. Clean the unit and decals using a damp cloth with a mild detergent.
- Wipe off unit with a clean dry cloth.

CLEAN AIR FILTER

A dirty air filter decreases engine performance and increases fuel consumption and harmful emissions. Always clean after every 5 hours of operation.

1. Clean the cover and the area around it to keep dirt from falling into the carburetor chamber when the cover is removed.
2. Loosen knob by turning counterclockwise. Remove air filter cover and air filter.

NOTE: To avoid creating a fire hazard or producing harmful evaporative emissions, do not clean filter in gasoline or other flammable solvent.

3. Wash the filter in soap and water.
4. Allow filter to dry.
5. Replace parts.

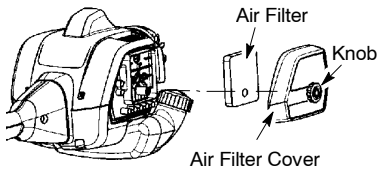

INSPECT MUFFLER AND SPARK ARRESTING SCREEN

WARNING: The muffler on this product contains chemicals known to the State of California to cause cancer. As your unit is used, carbon deposits build up on the muffler and spark arresting screen and must be removed to avoid creating a fire hazard or affecting engine performance.

For normal homeowner use, the muffler and spark arresting screen will not require any service. After 50 hours of use, we recommend that your muffler be serviced or replaced by an authorized service dealer.

REPLACE SPARK PLUG

Replace the spark plug each year to ensure the engine starts easier and runs better. Inspect spark plug every 25 hours of usage. Clean and/or replace as necessary. Set spark plug gap at 0.025 inch (0.6 mm). Ignition timing is fixed and nonadjustable.

NOTE: This spark ignition system complies with the Canadian standard ICES-002.

1. Twist, then pull off spark plug boot.
2. Remove spark plug from cylinder and discard.
3. Replace with Champion RCJ-6Y spark plug and tighten securely with a 3/4 inch (19 mm) socket wrench.
4. Reinstall the spark plug boot.

SERVICE AND ADJUSTMENTS

REPLACING THE LINE

For unit to operate properly, the cutting line should be replaced when line becomes worn to less than 3 inches (7.5 cm) in length from the edge of the line exit tunnels on each side of the cutting head.

1. Remove and discard worn line before installing new line.
2. Use only 0.115 inch (3 mm) diameter Poulan PRO brand cut length line.
3. Insert one end of the line through the positioning tunnel.
4. Continue to feed line through tunnel until line is centered (leaving equal amounts on each side). See illustration below.

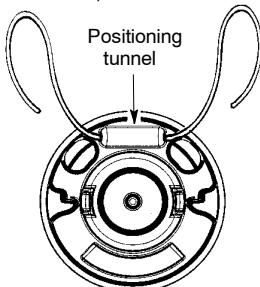

5. Insert ends of line one at a time through the line exit tunnels.
6. Pull the line and make sure the line is extended fully through the tunnels.

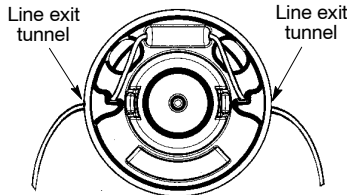

7. Correctly installed line will be the same length on both ends.

REPLACING THE CUTTING HEAD

1. Align hole in the dust cup with the hole in the side of the gearbox by rotating the dust cup.
2. Insert a small screwdriver into aligned holes. This will keep the shaft from turning while removing and installing trimmer head.

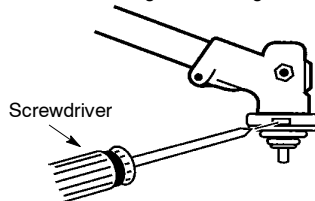

3. While holding the screwdriver in position, remove trimmer head by turning clockwise (looking from bottom of unit).
4. Thread replacement trimmer head onto the shaft by turning counterclockwise. Tighten until secure.
5. Remove the screwdriver.

CARBURETOR IDLE SPEED ADJUSTMENT

WARNING: Keep others away when making idle speed adjustments. The trimmer head, blade or any optional attachment will be spinning during most of this procedure. Wear your protective equipment and observe all safety precautions. After making adjustments, the trimmer head, blade or any optional attachment must not move/spin at idle speed.

The carburetor has been carefully set at the factory. Adjustments may be necessary if you notice any of the following conditions:

- Engine will not idle when the throttle is released.
- The trimmer head, blade or optional attachment moves/spins at idle.

Make adjustments with the unit supported so the cutting attachment is off the ground and will not make contact with any object. Hold the unit by hand while running and making adjustments. Keep all parts of your body away from the cutting attachment and muffler.

To adjust idle speed:

Allow engine to idle. Adjust speed until engine runs without trimmer head, blade or optional attachment moving or spinning (idle too fast) or stalling (idle speed too slow).

- Turn idle speed screw clockwise to increase engine speed if engine stalls or dies.
- Turn idle speed screw counterclockwise to decrease engine speed if trimmer head, blade or optional attachment moves or spins at idle.

WARNING: Recheck the idle speed after each adjustment. The trimmer head, blade or optional attachment must not move or spin at idle speed to avoid serious injury to the operator or others.

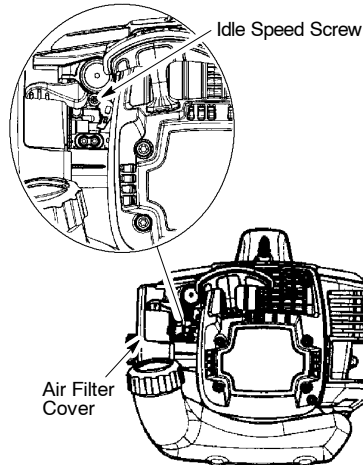

If you require further assistance or are unsure about performing this procedure, contact an authorized service dealer or call 1-800-554-6723.

STORAGE

WARNING: Perform the following steps after each use:

- Allow engine to cool before storing or transporting.
- Store unit and fuel in a well ventilated area where fuel vapors cannot reach sparks or open flames from water heaters, electric motors or switches, furnaces, etc.
- Store unit with all guards in place. Position unit so that any sharp object cannot accidentally cause injury.
- Store unit and fuel well out of the reach of children.

SEASONAL STORAGE

Prepare unit for storage at end of season or if it will not be used for 30 days or more.

If your unit is to be stored for a period of time:

- Clean the entire unit before lengthy storage.
- Store in a clean dry area.
- Lightly oil external metal surfaces.

FUEL SYSTEM

Under FUELING ENGINE in the OPERATION section of this manual, see message labeled IMPORTANT regarding the use of gasoline in your engine.

Fuel stabilizer is an acceptable alternative in minimizing the formation of fuel gum deposits during storage. Add stabilizer to the gasoline in the fuel tank or fuel storage container.

Follow the mix instructions found on stabilizer container. Run engine at least 5 minutes after adding stabilizer.

HELPFUL TIP

During storage of your gas/oil mixture, the oil will separate from the gas.

We recommend that you shake the gas can weekly to insure proper blending of the gas and oil.



ENGINE

- Remove spark plug and pour 1 teaspoon of 40:1, 2-cycle engine oil (air cooled) through the spark plug opening. Slowly pull the starter rope 8 to 10 times to distribute oil.
- Replace spark plug with new one of recommended type and heat range.
- Clean air filter.
- Check entire unit for loose screws, nuts, and bolts. Replace any damaged, broken, or worn parts.
- At the beginning of the next season, use only fresh fuel having the proper gasoline to oil ratio.

OTHER

- Do not store gasoline from one season to another.
- Replace your gasoline can if it starts to rust.

TROUBLESHOOTING TABLE

⚠ WARNING: Always stop unit and disconnect spark plug before performing all of the recommended remedies below except remedies that require operation of the unit.

| TROUBLE | CAUSE | REMEDY |
|--|--|---|
| Engine will not start. | <ol style="list-style-type: none"> 1. Engine flooded. 2. Fuel tank empty. 3. Spark plug not firing. 4. Fuel not reaching carburetor. 5. Carburetor requires adjustment. | <ol style="list-style-type: none"> 1. See "Starting a Flooded Engine" in Operation Section. 2. Fill tank with correct fuel mixture. 3. Install new spark plug. 4. Check for dirty fuel filter; replace. Check for kinked or split fuel line; repair or replace. 5. Contact an authorized service dealer. |
| Engine will not idle properly. | <ol style="list-style-type: none"> 1. Carburetor requires adjustment. 2. Crankshaft seals worn. 3. Compression low. | <ol style="list-style-type: none"> 1. See "Carburetor Idle Speed Adjustment" in Service and Adjustments Section. 2. Contact an authorized service dealer. 3. Contact an authorized service dealer. |
| Engine will not accelerate, lacks power, or dies under a load. | <ol style="list-style-type: none"> 1. Air filter dirty. 2. Spark plug fouled. 3. Carburetor requires adjustment. 4. Carbon build-up on muffler outlet screen. 5. Compression low. | <ol style="list-style-type: none"> 1. Clean or replace air filter. 2. Clean or replace plug and regap. 3. Contact an authorized service dealer. 4. Contact an authorized service dealer. 5. Contact an authorized service dealer. |
| Engine smokes excessively. | <ol style="list-style-type: none"> 1. Fuel mixture incorrect. 2. Air filter dirty. 3. Carburetor requires adjustment. | <ol style="list-style-type: none"> 1. Empty fuel tank and refill with correct fuel mixture. 2. Clean or replace air filter. 3. Contact an authorized service dealer. |
| Engine runs hot. | <ol style="list-style-type: none"> 1. Fuel mixture incorrect. 2. Spark plug incorrect. 3. Carburetor requires adjustment. 4. Carbon build-up on muffler outlet screen. | <ol style="list-style-type: none"> 1. See "Fueling Engine" in Operation section. 2. Replace with correct spark plug. 3. Contact an authorized service dealer. 4. Contact an authorized service dealer. |

LIMITED WARRANTY

Poulan PRO, a division of Husqvarna Consumer Outdoor Products N.A., Inc., warrants to the original consumer purchaser that each new **Poulan PRO** brand gasoline tool or attachment is free from defects in material and workmanship and agrees to repair or replace under this warranty any defective gasoline product or attachment as follows from the original date of purchase.

2 YEARS - Parts and Labor, when used for household purposes.

90 DAYS - Parts and Labor, when used for commercial, professional, or income producing purposes.

30 DAYS - Parts and Labor, if used for rental purposes.

This warranty is not transferable and does not cover damage or liability caused by improper handling, improper maintenance or alteration, or the use of accessories and/or attachments not specifically recommended by **Poulan PRO** for this tool. This warranty does not cover tune-up,

spark plugs, filters, starter ropes, cutting line, or rotating head parts that will wear and require replacement with reasonable use during the warranty period. This warranty does not cover pre-delivery setup or normal adjustments explained in the instruction manual. This warranty does not cover transportation costs.

In the event you have a claim under this warranty, you must return the product to an authorized service dealer.

Should you have any unanswered questions concerning this warranty, please contact: **Poulan PRO**, a division of Husqvarna Consumer Outdoor Products N.A., Inc. 7349 Statesville Road Charlotte, NC 28269 1-800-554-6723

In Canada, contact:

Poulan PRO

850 Matheson Blvd. West
Mississauga, Ontario L5V 0B4

Giving the model number, serial number and date of purchase of your product and the name and address of the authorized dealer from whom it was purchased.

THIS WARRANTY GIVES YOU SPECIFIC LEGAL RIGHTS, AND YOU MAY HAVE OTHER RIGHTS WHICH VARY FROM STATE TO STATE.

NO CLAIMS FOR CONSEQUENTIAL OR OTHER DAMAGES WILL BE ALLOWED, AND THERE ARE NO OTHER EXPRESS WARRANTIES EXCEPT THOSE EXPRESSLY STIPULATED HEREIN.

SOME STATES DO NOT ALLOW LIMITATIONS ON HOW LONG AN IMPLIED WARRANTY LASTS OR THE EXCLUSION OR LIMITATIONS OF INCIDENTAL OR CONSEQUENTIAL DAMAGES, SO THE ABOVE LIMITATIONS OR EXCLUSION MAY NOT APPLY TO YOU.

This is a limited warranty within the meaning of that term as defined in the Magnuson-Moss Act of 1975.

The policy of **Poulan PRO** is to continuously improve its products. Therefore, **Poulan PRO** reserves the right to change, modify, or discontinue models, designs, specifications, and accessories of all products at any time without notice or obligation to any purchaser.

U.S. EPA / CALIFORNIA / ENVIRONMENT CANADA EMISSION CONTROL WARRANTY STATEMENT

YOUR WARRANTY RIGHTS AND OBLIGATIONS: The U.S. Environmental Protection Agency, California Air Resources Board, Environment Canada and Poulan PRO are pleased to explain the emissions control system warranty on your year 2010 and later small off-road engine. In California, all small off-road engines must be designed, built, and equipped to meet the State's stringent anti-smog standards. Poulan PRO must warrant the emission control system on your small off-road engine for the periods of time listed below provided there has been no abuse, neglect, or improper maintenance of your small off-road engine. Your emission control system includes parts such as the carburetor, the ignition system and the fuel tank. Where a warrantable condition exists, Poulan PRO will repair your small off-road engine at no cost to you. Expenses covered under warranty include diagnosis, parts and labor. **MANUFACTURER'S WARRANTY COVERAGE:** If any emissions related part on your engine (as listed under Emissions Control Warranty Parts List) is defective or a defect in the materials or workmanship of the engine causes the failure of such an emission related part, the part will be repaired or replaced by Poulan PRO. **OWNER'S WARRANTY RESPONSIBILITIES:** As the small off-road engine owner, you are responsible for the performance of the required maintenance listed in your instruction manual. Poulan PRO recommends that you retain all receipts covering maintenance on your small off-road engine, but Poulan PRO cannot deny warranty solely for the lack of receipts or for your failure to ensure the performance of all scheduled maintenance. As the small off-road engine owner, you should be aware that Poulan PRO may deny you warranty coverage if your small off-road engine or a part of it has failed due to abuse, neglect, improper maintenance, unapproved modifications, or the use of parts not made or approved by the original equipment manufacturer. You are responsible for presenting your small off-road engine to an Poulan PRO authorized repair center as soon as a problem exists.

Warranty repairs should be completed in a reasonable amount of time, not to exceed 30 days. If you have any questions regarding your warranty rights and responsibilities, you should contact your nearest authorized service center, call Poulan PRO at 1-800-554-6723, or send e-mail correspondence to emission.warranty@HCOP-emission.com. **WARRANTY COMMENCEMENT DATE:** The warranty period begins on the date the small off-road engine is purchased. **LENGTH OF COVERAGE:** This warranty shall be for a period of two years from the initial date of purchase, or until the end of the product warranty (whichever is longer). **WHAT IS COVERED: REPAIR OR REPLACEMENT OF PARTS.** Repair or replacement of any warranted part will be performed at no charge to the owner at an approved Poulan PRO servicing center. If you have any questions regarding your warranty rights and responsibilities, you should contact your nearest authorized service center, call Poulan PRO at 1-800-554-6723, or send e-mail correspondence to emission.warranty@HCOP-emission.com. **WARRANTY PERIOD:** Any warranted part which is not scheduled for replacement as required maintenance, or which is scheduled only for regular inspection to the effect of "repair or replace as necessary" shall be warranted for 2 years. Any warranted part which is scheduled for replacement as required maintenance shall be warranted for the period of time up to the first scheduled replacement point for that part. **DIAGNOSIS:** The owner shall not be charged for diagnostic labor which leads to the determination that a warranted part is defective if the diagnostic work is performed at an approved Poulan PRO servicing center. **CONSEQUENTIAL DAMAGES:** Poulan PRO may be liable for damages to other engine components caused by the failure of a warranted part still under warranty. **WHAT IS NOT COVERED:** All failures caused by abuse, neglect, or improper maintenance are not covered.

ADD-ON OR MODIFIED PARTS: The use of add-on or modified parts can be grounds for disallowing a warranty claim. Poulan PRO is not liable to cover failures of warranted parts caused by the use of add-on or modified parts. **HOW TO FILE A CLAIM:** If you have any questions regarding your warranty rights and responsibilities, you should contact your nearest authorized service center, call Poulan PRO at 1-800-554-6723, or send e-mail correspondence to emission.warranty@HCOP-emission.com. **WHERE TO GET WARRANTY SERVICE:** Warranty services or repairs shall be provided at all Poulan PRO service centers. Call: 1-800-554-6723 or send e-mail correspondence to emission.warranty@HCOP-emission.com.

MAINTENANCE, REPLACEMENT AND REPAIR OF EMISSION RELATED PARTS: Any Poulan PRO approved replacement part used in the performance of any warranty maintenance or repair on emission related parts will be provided without charge to the owner if the part is under warranty. **EMISSION CONTROL WARRANTY PARTS LIST:** Carburetor, air filter (covered up to maintenance schedule), ignition system: spark plug (covered up to maintenance schedule), ignition module, muffler including catalyst (if equipped), fuel tank. **MAINTENANCE STATEMENT:** The owner is responsible for the performance of all required maintenance as defined in the instruction manual.

The information on the product label indicates which standard your engine is certified.
Example: (Year) EPA and/or CALIFORNIA.

| | | | | | |
|---|-------|-------|-------|-------|--------|
| EMISSION CONTROL INFORMATION THIS ENGINE MEETS EXH. AND EVAP. EMISSIONS REGULATIONS FOR SMALL OFF ROAD ENGINES | | | | | |
| POULAN/WEED EATER, 2010 US EPA/CALIF. | | | | | |
| FAMILY/DISP | | | | | |
| MODEL# | | | | | |
| COMPLIANCE PERIOD | HOURS | | | | |
| [] BAR CODE [] | | | | | |
| THE AIR INDEX OF THIS ENGINE IS | | | | | |
| [0] | [2] | [4] | [6] | [8] | [10] |
| THE LOWER THE AIR INDEX, THE LESS POLLUTION REFER TO OWNER'S MANUAL FOR MAINTENANCE SPECIFICATIONS AND ADJUSTMENTS. | | | | | |

This engine is certified to be emissions compliant for the following use:

- Moderate (50 hours)
- Intermediate (125 hours)
- Extended (300 hours)

Free Manuals Download Website

<http://myh66.com>

<http://usermanuals.us>

<http://www.somanuals.com>

<http://www.4manuals.cc>

<http://www.manual-lib.com>

<http://www.404manual.com>

<http://www.luxmanual.com>

<http://aubethermostatmanual.com>

Golf course search by state

<http://golfingnear.com>

Email search by domain

<http://emailbydomain.com>

Auto manuals search

<http://auto.somanuals.com>

TV manuals search

<http://tv.somanuals.com>