

# **PowerTech™ 4.5 L and 6.8 L Non-Certified and Tier 1 Certified OEM Diesel Engines**

## **OPERATOR'S MANUAL PowerTech™ 4.5 L and 6.8 L Non-Certified and Tier 1 Certified OEM Diesel Engines**

**OMRG25204 Issue 02Nov06 (ENGLISH)**

### **CALIFORNIA Proposition 65 Warning**

Diesel engine exhaust and some of its constituents are known to the State of California to cause cancer, birth defects, and other reproductive harm.

If this product contains a gasoline engine:

### **WARNING**

The engine exhaust from this product contains chemicals known to the State of California to cause cancer, birth defects or other reproductive harm.

The State of California requires the above two warnings.

**John Deere Power Systems**  
LITHO IN U.S.A.

# Introduction

## Foreword

This manual contains information to operate and service the following 4.5 L & 6.8 L non-certified and Tier 1<sup>1</sup> emission certified OEM engines built at Dubuque Iowa (T0), Saran France (CD) and Torreon Mexico (PE) from 1996 on. These engines have mechanically-controlled fuel systems.

### SARAN BUILT NON-CERTIFIED ENGINES

- CD4045DF120
- CD4045TF120
- CD4045TF220
- CD4045HF120
- CD6068TF120
- CD6068TF220
- CD6068HF120

### TORREON BUILT NON-CERTIFIED ENGINES

- PE4045TF120
- PE4045TF220
- PE4045HF120
- PE6068TF120
- PE6068TF220
- PE6068HF120

### DUBUQUE BUILT NON-CERTIFIED ENGINES

- T04045DF120
- T04045TF120
- T04045TF220
- T04045HF120

### SARAN BUILT TIER 1 CERTIFIED ENGINES

- CD4045DF150
- CD4045DF151
- CD4045DF152
- CD4045DF153
- CD4045DF154
- CD4045DF157
- CD4045DF158

- CD4045TF150
- CD4045TF152
- CD4045TF154
- CD4045TF155
- CD4045TF157
- CD4045TF158
- CD4045TF161
- CD4045TF162
- CD4045TF250
- CD4045TF251
- CD4045TF252
- CD4045TF253
- CD4045TF257
- CD4045TF258
- CD4045HF150
- CD4045HF152
- CD4045HF157
- CD4045HF158
- CD4045HF252
- CD6068DF150
- CD6068TF150
- CD6068TF151
- CD6068TF152
- CD6068TF157
- CD6068TF158
- CD6068TF159
- CD6068TF250
- CD6068TF251
- CD6068TF257
- CD6068TF258
- CD6068HF150
- CD6068HF157
- CD6068HF158
- CD6068HF250
- CD6068HF252
- CD6068HF254
- CD6068HF258

### TORREON BUILT TIER 1 CERTIFIED ENGINES

- PE4045DF150
- PE4045TF150

<sup>1</sup>Emission certified for United States as EPA Tier 1 and European Union as Stage 1.

- PE4045TF151
- PE4045HF150
- PE4045HF252
- PE6068DF150
- PE6068TF150
- PE6068TF151
- PE6068TF250
- PE6068HF150
- PE6068HF250

#### DUBUQUE BUILT TIER 1 CERTIFIED ENGINES

- T04045DF150
- T04045DF151
- T04045DF152
- T04045DF153
- T04045TF150
- T04045TF151
- T04045TF152
- T04045TF250
- T04045TF251
- T04045HF120
- T04045HF150
- T06068DF150
- T06068TF150
- T06068TF151
- T06068TF250
- T06068HF150
- T06068HF250

*NOTE: Before 2005, all Non-certified and Tier 1 Certified Saran built engines used the following serial number sequences:*

- (CDxxxxD500000) - (CDxxxxD799999)
- (CDxxxxT500000) - (CDxxxxT799999)
- (CDxxxxH500000) - (CDxxxxH799999)

*Since 2005, non-certified engines have the seventh digit of the serial number as "B" while Tier 1 certified engines have the seventh digit as "C".*

READ THIS MANUAL carefully to learn how to operate and service your engine correctly. Failure to do so could result in personal injury or equipment damage.

THIS MANUAL SHOULD BE CONSIDERED a permanent part of your engine and should remain with the engine when you sell it.

MEASUREMENTS IN THIS MANUAL are given in both metric and customary U.S. unit equivalents. Use only correct replacement parts and fasteners. Metric and inch fasteners may require a specific metric or inch wrench.

RIGHT-HAND AND LEFT-HAND sides are determined by standing at the drive or flywheel end (rear) of the engine and facing toward the front of the engine.

WRITE ENGINE SERIAL NUMBERS and option codes in the spaces indicated in the Record Keeping Section. Accurately record all the numbers. Your dealer also needs these numbers when you order parts. File the identification numbers in a secure place off the engine.

SETTING FUEL DELIVERY beyond published factory specifications or otherwise overpowering will result in loss of warranty protection for this engine.

CERTAIN ENGINE ACCESSORIES such as radiator, air cleaner, and instruments are optional equipment on John Deere OEM Engines. These accessories may be provided by the equipment manufacturer instead of John Deere. This operator's manual applies only to the engine and those options available through the John Deere distribution network.

*NOTE: This operators manual covers only engines provided to OEM (Outside Equipment Manufacturers). For engines in Deere machines, refer to the machine operators manual.*

## Engine Owner

### John Deere Engine Owner:

Don't wait until you need warranty or other service to meet your local John Deere Engine Distributor or Service Dealer. To register your engine for warranty via the Internet, use the following URL:

<http://www.johndeere.com/enginewarranty>

Learn who your dealer is and where he is. At your first convenience, go meet him. He'll want to get to know you and to learn what your needs might be.

### Aux Utilisateurs De Moteurs John Deere:

N'attendez pas d'être obligé d'avoir recours à votre concessionnaire John Deere ou au point de service le plus proche pour vous adresser à lui. Pour enregistrer votre moteur pour la garantie via Internet, utilisez l'adresse suivante:

<http://www.johndeere.com/enginewarranty>

Renseignez-vous dès que possible pour l'identifier et le localiser. A la première occasion, prenez contact avec lui et faites-vous connaître. Il sera lui aussi heureux de faire votre connaissance et de vous proposer ses services le moment venu.

### An Den Besitzer Des John Deere Motors:

Warten Sie nicht auf einen evt. Reparaturfall, um den nächstgelegenen John Deere Händler kennen zu lernen. Zur Registrierung Ihres Motors für die Garantie dient folgende Internet-Adresse:

<http://www.johndeere.com/enginewarranty>

Machen Sie sich bei ihm bekannt und nutzen Sie sein "Service Angebot".

### Proprietario del motore John Deere:

Non aspetti fino al momento di far valere la garanzia o di chiedere assistenza per fare la conoscenza del

distributore dei motori John Deere o del concessionario che fornisce l'assistenza tecnica. Per registrare via Internet la garanzia del suo motore, si colleghi al seguente sito URL:

<http://www.johndeere.com/enginewarranty>

Lo identifichi e si informi sulla sua ubicazione. Alla prima occasione utile lo contatti. Egli desidera fare la sua conoscenza e capire quali potrebbero essere le sue necessità.

### Propietario De Equipo John Deere:

No espere hasta necesitar servicio de garantía o de otro tipo para conocer a su Distribuidor de Motores John Deere o al Concesionario de Servicio. Registre su motor para la garantía en la siguiente dirección de internet: <http://www.johndeere.com/enginewarranty>

Entérese de quién es, y dónde está situado. Cuando tenga un momento, vaya a visitarlo. A él le gustará conocerlo, y saber cuáles podrían ser sus necesidades.

### Till ägare av John Deere motorer:

Ta reda på vem din återförsäljare är och besök honom så snart tillfälle ges. Vänta inte tills det är dags för service eller eventuellt garantiarbete. Din motor garantiregistrerar Du via Internet på <http://www.johndeere.com/enginewarranty>

Din återförsäljare vill mycket gärna träffa dig för att lära känna dina behov och hur bäst han kan hjälpa dig.

**POWERTECH® 4.5 L Engines With Mechanical Controls (Tier 1 Emission Certified)**

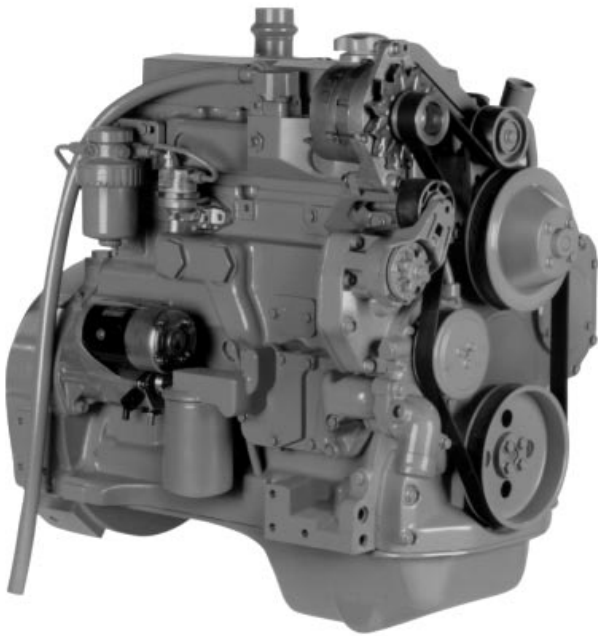

4045D Engine

RG7999 -UN-19JUN00

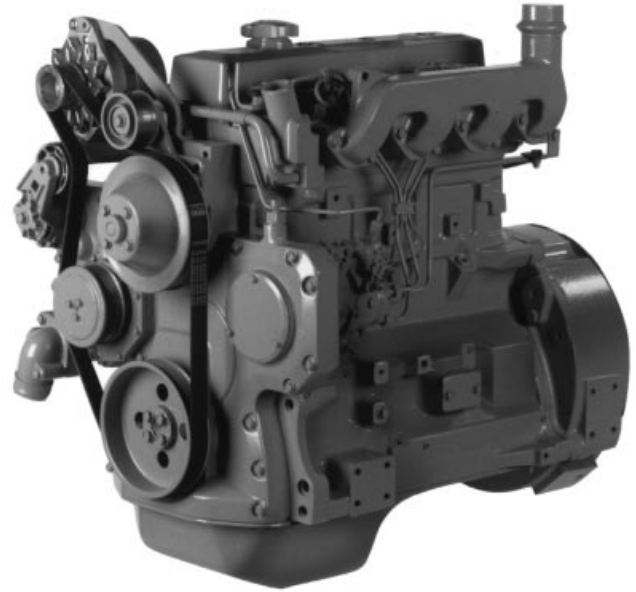

4045D Engine

RG7998 -UN-19JUN00

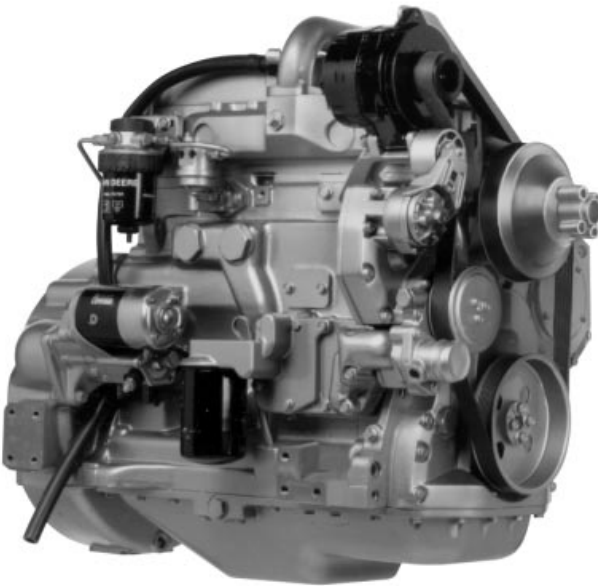

4045T Engine

RG7996 -UN-19JUN00

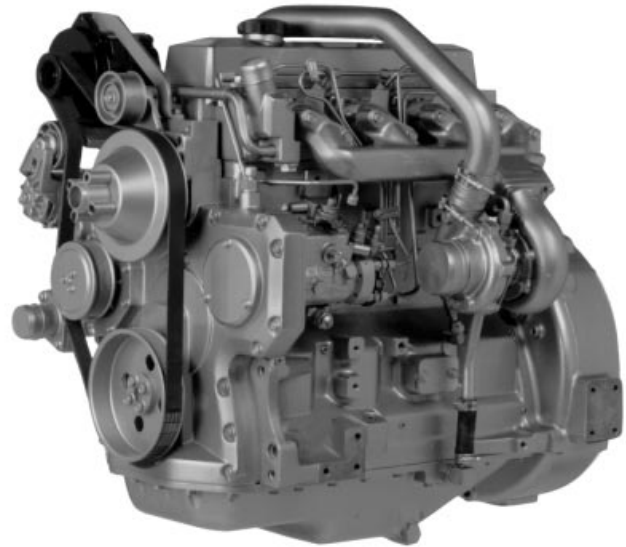

4045T Engine

RG7997 -UN-19JUN00

POWERTECH is a trademark of Deere & Company

RG, RG34710, 5501 -19-04JAN02-1/1

**POWERTECH® 6.8 L Engines With Mechanical Controls (Tier 1 Emission Certified)**

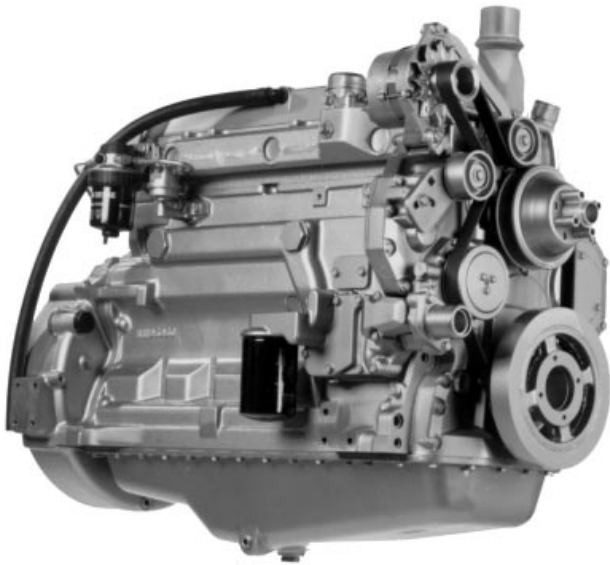

6068D Engine

RG8003 -UN-19JUN00

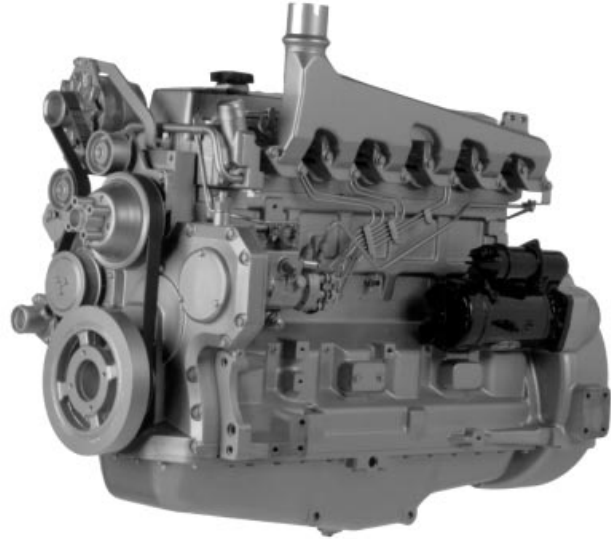

6068D Engine

RG8002 -UN-19JUN00



6068T Engine

RG8001 -UN-19JUN00

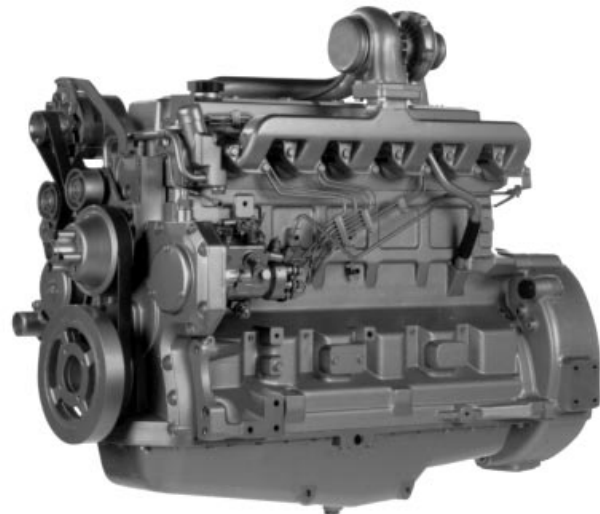

6068T Engine

RG8000 -UN-19JUN00

POWERTECH is a trademark of Deere & Company

RG, RG34710, 5503 -19-04JAN02-1/1

# Contents

	Page	Page
<b>Record Keeping</b>		
PowerTech Medallion . . . . .	01-1	
Engine Serial Number Plate . . . . .	01-1	
Record Engine Serial Number . . . . .	01-2	
Engine Option Codes . . . . .	01-3	
Record Fuel Injection Pump Model Number . . . . .	01-5	
<b>Safety</b> . . . . .	05-1	
<b>Fuels, Lubricants, and Coolant</b>		
Diesel Fuel . . . . .	10-1	
Lubricity of Diesel Fuel . . . . .	10-1	
Handling and Storing Diesel Fuel . . . . .	10-2	
Testing Diesel Fuel . . . . .	10-2	
Bio-Diesel Fuel . . . . .	10-3	
Aviation (Jet) Fuels . . . . .	10-4	
Burner Fuels . . . . .	10-4	
Minimizing the Effect of Cold Weather on Diesel Engines . . . . .	10-5	
Diesel Engine Break-In Oil . . . . .	10-6	
Diesel Engine Oil . . . . .	10-7	
Extended Diesel Engine Oil Service Intervals . . . . .	10-8	
Mixing of Lubricants . . . . .	10-8	
OILSCAN™ and COOLSCAN™ . . . . .	10-9	
Alternative and Synthetic Lubricants . . . . .	10-9	
Lubricant Storage . . . . .	10-10	
Oil Filters . . . . .	10-10	
Grease . . . . .	10-11	
Diesel Engine Coolant . . . . .	10-12	
Drain Intervals for Diesel Engine Coolant . . . . .	10-13	
Additional Information About Diesel Engine Coolants and Supplemental Coolant Additives . . . . .	10-14	
Supplemental Coolant Additives . . . . .	10-15	
Additional Information About Diesel Engine Coolants and Supplemental Coolant Additives . . . . .	10-16	
Testing Diesel Engine Coolant . . . . .	10-17	
Operating in Warm Temperature Climates . . . . .	10-18	
Disposing of Coolant . . . . .	10-18	
<b>Engine Operating Guidelines</b>		
Instrument (Gauge) Panels . . . . .	15-1	
Instrument (Gauge) Panel (North America) . . . . .		15-2
VDO Instrument (Gauge) Panel (Except North America) . . . . .		15-4
Engine Break-In Service . . . . .		15-6
Auxiliary Gear Drive Limitations . . . . .		15-9
Generator Set (Standby) Applications . . . . .		15-9
Starting the Engine . . . . .		15-10
Warming Engine . . . . .		15-12
Normal Engine Operation . . . . .		15-13
Cold Weather Operation . . . . .		15-14
Changing Engine Speed . . . . .		15-15
Avoid Excessive Engine Idling . . . . .		15-15
Stopping the Engine . . . . .		15-16
Using a Booster Battery or Charger . . . . .		15-17
<b>Lubrication and Maintenance</b>		
Observe Service Intervals . . . . .		20-1
Use Correct Fuels, Lubricants, and Coolant . . . . .		20-1
Lubrication and Maintenance Service Interval Chart—Standard Industrial Engines . . . . .		20-2
Lubrication and Maintenance Service Interval Chart—Generator (Standby) Applications . . . . .		20-4
<b>Lubrication &amp; Maintenance/Daily</b>		
Daily Prestarting Checks . . . . .		25-1
<b>Lubrication &amp; Maintenance/250 Hour/6 Month</b>		
Servicing Fire Extinguisher . . . . .		30-1
Changing Engine Oil and Replacing Filter . . . . .		30-2
Checking Engine Mounts . . . . .		30-4
Servicing Battery . . . . .		30-5
Manual Belt Tensioner Adjustment . . . . .		30-7
Manual Belt Tensioner Adjustment Using Belt Tension Tool (Alternate Method For Engines Without Auxiliary Drive) . . . . .		30-8
<b>Lubrication &amp; Maintenance/500 Hour/12 Month</b>		
Cleaning Crankcase Vent Tube . . . . .		35-1
Checking Air Intake System . . . . .		35-2
Replacing Fuel Filter Element (Single Filter) . . . . .		35-3

Continued on next page

*All information, illustrations and specifications in this manual are based on the latest information available at the time of publication. The right is reserved to make changes at any time without notice.*

COPYRIGHT © 2006  
DEERE & COMPANY  
Moline, Illinois  
All rights reserved  
A John Deere ILLUSTRATION® Manual  
Previous Editions  
Copyright © 1996, 2000, 2002, 2004

Page	Page		
Replacing Fuel Filter Elements (Dual Filters) . . .	35-5	<b>Specifications</b>	
Checking Belt Tensioner Spring Tension and Belt Wear (Automatic Tensioner) . . . . .	35-6	General OEM Engine Specifications—4.5 L Engines. . . . .	60-1
Checking Engine Speeds . . . . .	35-9	General OEM Engine Specifications—6.8 L Engines. . . . .	60-2
Checking Engine Electrical Ground Connections . . . . .	35-9	Engine Power Ratings And Fuel Injection Pump Specifications . . . . .	60-3
Checking Cooling System. . . . .	35-10	Engine Crankcase Oil Fill Quantities . . . . .	60-11
Replenishing Supplemental Coolant Additives (SCAs) Between Coolant Changes . . . . .	35-11	Unified Inch Bolt and Screw Torque Values . . .	60-15
Testing Diesel Engine Coolant . . . . .	35-12	Metric Bolt and Screw Torque Values. . . . .	60-16
Pressure Testing Cooling System. . . . .	35-13		
<b>Lubrication &amp; Maint./2000 Hour/24 Month</b>		<b>Lubrication and Maintenance Records</b>	
Adjusting Variable Speed (Droop) on Generator Set Engines . . . . .	40-1	Using Lubrication and Maintenance Records . . .	65-1
Checking Crankshaft Vibration Damper (6-Cylinder Engine Only). . . . .	40-3	Daily (Prestarting) Service . . . . .	65-1
Flushing and Refilling Cooling System . . . . .	40-4	250 Hour/6 Month Service . . . . .	65-2
Testing Thermostats Opening Temperature . . . .	40-7	500 Hour/12 Month Service . . . . .	65-3
Check and Adjust Valve Clearance . . . . .	40-10	2000 Hour/24 Month Service . . . . .	65-4
		Service as Required . . . . .	65-5
<b>Service as Required</b>		<b>Emission System Warranty</b>	
Additional Service Information . . . . .	45-1	U.S. EPA Emissions Control Warranty	
Do Not Modify Fuel System . . . . .	45-1	Statement . . . . .	70-1
Adding Coolant. . . . .	45-2	Emissions Control System Certification Label. . .	70-1
Replacing Single Stage Air Cleaner . . . . .	45-3		
Replacing Axial Seal Air Cleaner Filter Element . . . . .	45-4		
Replacing Radial Seal Air Cleaner Filter Element . . . . .	45-6		
Replacing Fan and Alternator Belts . . . . .	45-8		
Checking Fuses In Instrument Panels . . . . .	45-9		
Checking Air Compressors . . . . .	45-10		
Bleeding the Fuel System. . . . .	45-11		
<b>Troubleshooting</b>			
General Troubleshooting Information . . . . .	50-1		
Engine Wiring Diagram Legend (Standard Instrument Panel For North America). . . . .	50-3		
Wiring Diagram (Standard Instrument Panel For North America) . . . . .	50-4		
Engine Wiring Diagram—VDO Instrument Panel (Except North America) . . . .	50-5		
Engine Wiring Diagram Legend—VDO Instrument Panel (Except North America) . . . .	50-6		
Engine Troubleshooting . . . . .	50-7		
<b>Storage</b>			
Engine Storage Guidelines . . . . .	55-1		
Preparing Engine for Long Term Storage . . . . .	55-2		
Removing Engine from Long Term Storage . . . .	55-3		



# Record Keeping

## *POWERTECH*<sup>®</sup> Medallion

A medallion is located on the rocker arm cover which identifies each engine as a John Deere *POWERTECH*<sup>®</sup> engine.



RG11608 -UN-17OCT01



RG11609 -UN-17OCT01

*POWERTECH* is a trademark of Deere & Company.

RG, RG34710, 5505 -19-04JAN02-1/1

## Engine Serial Number Plate

Each engine has a 13-digit John Deere engine serial number. The first two digits identify the factory that produced the engine:

- "T0" indicates the engine was built in Dubuque, Iowa
- "CD" indicates the engine was built in Saran, France
- "PE" indicates the engine was built in Torreón, Mexico
- "J0" indicates the engine was built in Rosario, Argentina

Your engine's serial number plate (A) is located on the right-hand side of cylinder block behind the fuel filter.

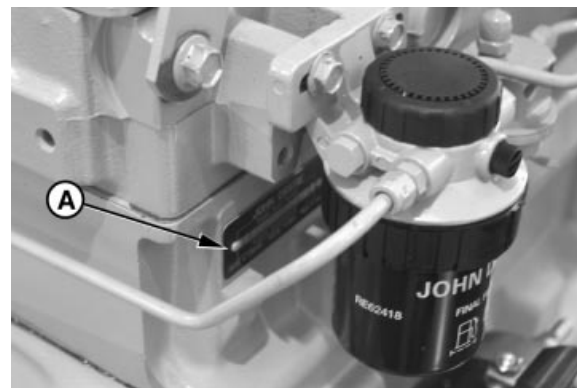

RG8007 -UN-15JAN99

13-Digit Engine Serial Number Plate

RG, RG34710, 5506 -19-04JAN02-1/1

### Record Engine Serial Number

Record all of the numbers and letters found on your engine serial number plate in the spaces provided below.

This information is very important for repair parts or warranty information.

Engine Serial Number (B)

---

Engine Model Number (C)

---

Coefficient of Absorption Value (D)  
(Saran Engines Only)

---



Dubuque Engine Serial Number Plate

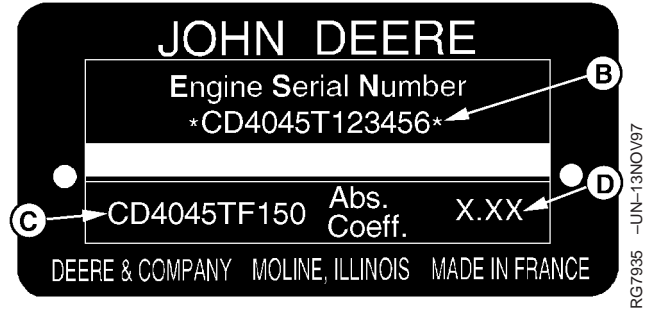

Saran Engine Serial Number Plate

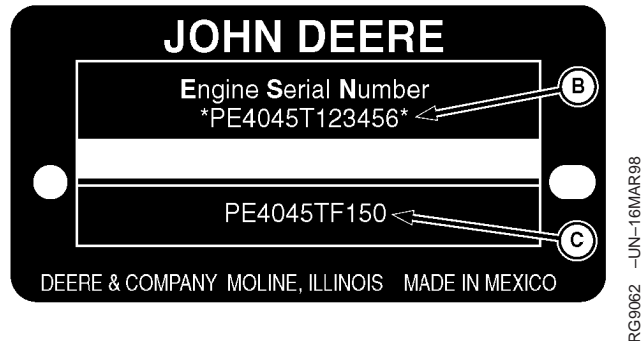

Torreon Engine Serial Number Plate

RG, RG34710, 5507 -19-04JAN02-1/1

## Engine Option Codes

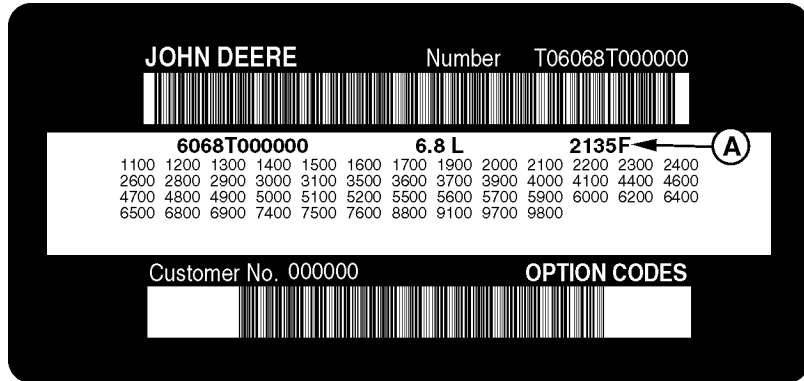

Engine Option Codes

A—Engine Base Code

In addition to the serial number plate, OEM engines have an engine option code label affixed to the rocker arm cover. These codes indicate which of the engine options were installed on your engine at the factory. When in need of parts or service, furnish your authorized servicing dealer or engine distributor with these numbers.

The engine option code label includes an engine base code (A). This base code must also be recorded along with the option codes.

The first two digits of each code identify a specific group, such as alternators. The last two digits of each code identify one specific option provided on your engine, such as a 12-volt, 55-amp alternator.

*NOTE: These option codes are based on the latest information available at the time of publication. The right is reserved to make changes at any time without notice.*

If an engine is ordered without a particular component, the last two digits of that functional group option code will be 99, 00, or XX. The list on the next page shows only the first two digits of the code numbers. For future reference such as ordering repair parts, it is important to have these code numbers available. To ensure this availability, enter the third and fourth digits shown on your engine option code label in the spaces provided on the following page.

Continued on next page

OURGP11,0000005 -19-24JUN04-1/2

**NOTE:** Your engine option code label may not contain all option codes if an option has been added after the engine left the producing factory.

If option code label is lost or destroyed, consult your servicing dealer or engine distributor selling the engine for a replacement.

An additional option code label may also be delivered with the engine. Place this sticker or tag, for reference, either on this page or in the engine owner's warranty booklet under **OPTION CODES** title.

Option Codes	Description	Option Codes	Description
11_____	Rocker Arm Cover	45_____	Balancer Shafts
12_____	Oil Fill Inlet	46_____	Cylinder Block With Liners and Camshaft
13_____	Crankshaft Pulley	47_____	Crankshaft and Bearings
14_____	Flywheel Housing	48_____	Connecting Rods and Pistons
15_____	Flywheel	49_____	Valve Actuating Mechanism
16_____	Fuel Injection Pump	50_____	Oil Pump
17_____	Air Inlet	51_____	Cylinder Head With Valves
18_____	Air Cleaner	52_____	Auxiliary Gear Drive
19_____	Oil Pan	55_____	Shipping Stand
20_____	Coolant Pump	56_____	Paint Option
21_____	Thermostat Cover	57_____	Coolant Pump Inlet
22_____	Thermostat	59_____	Oil Cooler
23_____	Fan Drive	60_____	Add-on Auxiliary Drive Pulley
24_____	Fan Belt	62_____	Alternator Mounting Bracket
25_____	Fan	64_____	Exhaust Elbow
26_____	Engine Coolant Heater	65_____	Turbocharger
27_____	Radiator	66_____	Coolant Temperature Switch
28_____	Exhaust Manifold	67_____	Electronic Tachometer Sensor
29_____	Crankcase Ventilator System	68_____	Crankshaft Rear Damper
30_____	Starter Motor	69_____	Engine Serial Number Plate
31_____	Alternator	74_____	Air Conditioning (Freon) Compressor
32_____	Instrument Panel	75_____	Air Restriction Indicator
33_____	Tachometer	76_____	Oil Pressure Switch
35_____	Fuel Filters	78_____	Air Compressor
36_____	Front Plate	81_____	Water Separator
37_____	Fuel Transfer Pump	86_____	Fan Pulley
39_____	Thermostat Housing	87_____	Belt Tensioner
40_____	Oil Dipstick	88_____	Oil Filter
41_____	Belt-Driven Front Auxiliary Drive	95_____	Special Equipment (Factory Installed)
43_____	Starting Aid	97_____	Special Equipment (Field Installed)
44_____	Timing Gear Cover With Gears	98_____	Shipping
		99_____	Service Only Items

**Engine Base Code** (See "A" on previous page.)

### Record Fuel Injection Pump Model Number

Record the fuel injection pump model and serial information found on the serial number plate (A).

Model No. \_\_\_\_\_ RPM \_\_\_\_\_

Manufacturer's No. \_\_\_\_\_

Serial No. \_\_\_\_\_

**A—Serial Number Plate**

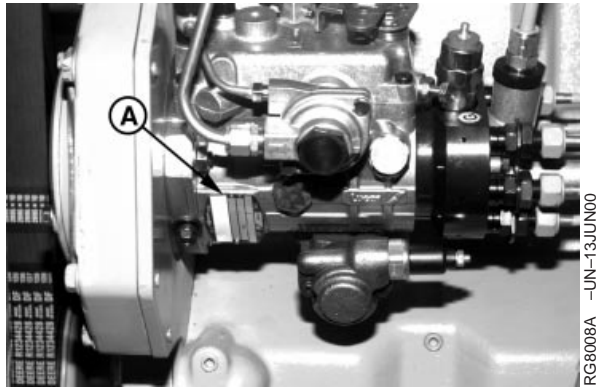

Record Injection Pump Serial Number

RG, RG34710, 5511 -19-20MAY96-1/1

# Safety

## Recognize Safety Information

This is a safety-alert symbol. When you see this symbol on your machine or in this manual, be alert to the potential for personal injury.

Follow recommended precautions and safe operating practices.



DX,ALERT -19-29SEP98-1/1

TS1389 -UN-07DEC88

## Understand Signal Words

A signal word—DANGER, WARNING, or CAUTION—is used with the safety-alert symbol. DANGER identifies the most serious hazards.

DANGER or WARNING safety signs are located near specific hazards. General precautions are listed on CAUTION safety signs. CAUTION also calls attention to safety messages in this manual.



**▲ WARNING**

**▲ CAUTION**

DX,SIGNAL -19-03MAR93-1/1

TS187 -19-30SEP88

## Follow Safety Instructions

Carefully read all safety messages in this manual and on your machine safety signs. Keep safety signs in good condition. Replace missing or damaged safety signs. Be sure new equipment components and repair parts include the current safety signs. Replacement safety signs are available from your John Deere dealer.

Learn how to operate the machine and how to use controls properly. Do not let anyone operate without instruction.

Keep your machine in proper working condition. Unauthorized modifications to the machine may impair the function and/or safety and affect machine life.

If you do not understand any part of this manual and need assistance, contact your John Deere dealer.



DX,READ -19-03MAR93-1/1

TS201 -UN-23AUG88

### Replace Safety Signs

Replace missing or damaged safety signs. See the machine operator's manual for correct safety sign placement.

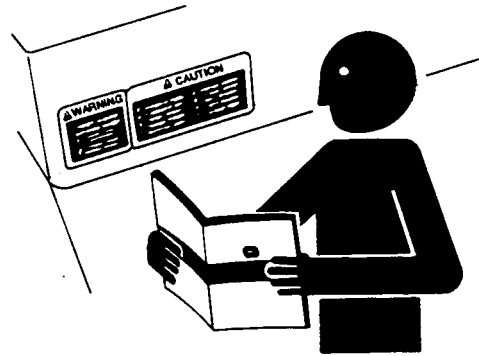

DX,SIGNS1 -19-04JUN90-1/1

TS201 -UN-23AUG88

### Prevent Machine Runaway

Avoid possible injury or death from machinery runaway.

Do not start engine by shorting across starter terminals. Machine will start in gear if normal circuitry is bypassed.

NEVER start engine while standing on ground. Start engine only from operator's seat, with transmission in neutral or park.

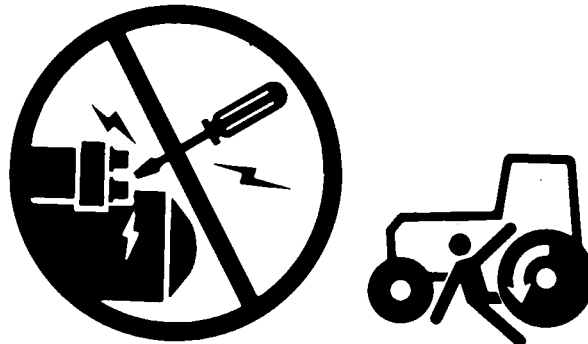

DX,BYPAS1 -19-29SEP98-1/1

TS177 -UN-11JAN89

### Handle Fuel Safely—Avoid Fires

Handle fuel with care: it is highly flammable. Do not refuel the machine while smoking or when near open flame or sparks.

Always stop engine before refueling machine. Fill fuel tank outdoors.

Prevent fires by keeping machine clean of accumulated trash, grease, and debris. Always clean up spilled fuel.



DX,FIRE1 -19-03MAR93-1/1

TS202 -UN-23AUG88

### Prepare for Emergencies

Be prepared if a fire starts.

Keep a first aid kit and fire extinguisher handy.

Keep emergency numbers for doctors, ambulance service, hospital, and fire department near your telephone.

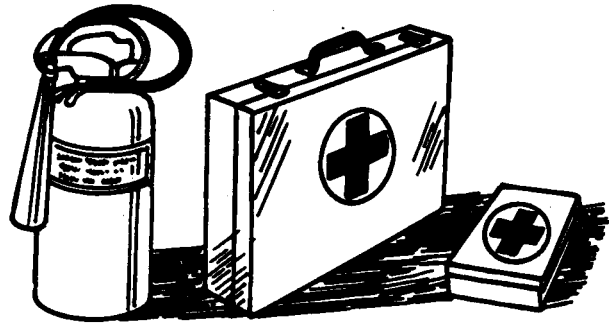

TS291 -UN-23AUG88

DX,FIRE2 -19-03MAR93-1/1

### Handle Starting Fluid Safely

Starting fluid is highly flammable.

Keep all sparks and flame away when using it. Keep starting fluid away from batteries and cables.

To prevent accidental discharge when storing the pressurized can, keep the cap on the container, and store in a cool, protected location.

Do not incinerate or puncture a starting fluid container.



TS1356 -UN-18MAR92

DX,FIRE3 -19-16APR92-1/1

### Handle Fluids Safely—Avoid Fires

When you work around fuel, do not smoke or work near heaters or other fire hazards.

Store flammable fluids away from fire hazards. Do not incinerate or puncture pressurized containers.

Make sure machine is clean of trash, grease, and debris.

Do not store oily rags; they can ignite and burn spontaneously.



TS227 -UN-23AUG88

DX,FLAME -19-29SEP98-1/1



### Service Machines Safely

Tie long hair behind your head. Do not wear a necktie, scarf, loose clothing, or necklace when you work near machine tools or moving parts. If these items were to get caught, severe injury could result.

Remove rings and other jewelry to prevent electrical shorts and entanglement in moving parts.

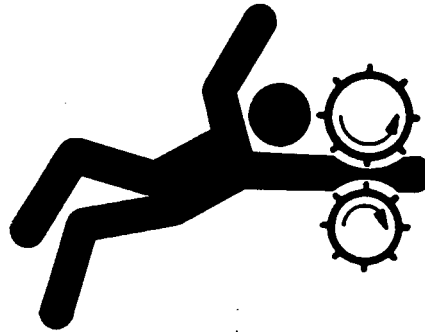

TS228 -UN-23AUG88

DX,LOOSE -19-04JUN90-1/1

### Wear Protective Clothing

Wear close fitting clothing and safety equipment appropriate to the job.

Prolonged exposure to loud noise can cause impairment or loss of hearing.

Wear a suitable hearing protective device such as earmuffs or earplugs to protect against objectionable or uncomfortable loud noises.

Operating equipment safely requires the full attention of the operator. Do not wear radio or music headphones while operating machine.

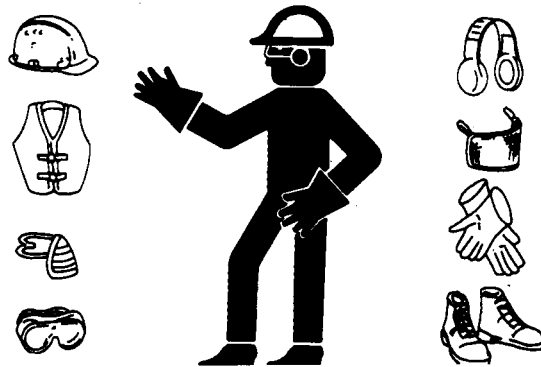

TS206 -UN-23AUG88

DX,WEAR -19-10SEP90-1/1

### Protect Against Noise

Prolonged exposure to loud noise can cause impairment or loss of hearing.

Wear a suitable hearing protective device such as earmuffs or earplugs to protect against objectionable or uncomfortable loud noises.



TS207 -UN-23AUG88

DX,NOISE -19-03MAR93-1/1

## Handle Chemical Products Safely

Direct exposure to hazardous chemicals can cause serious injury. Potentially hazardous chemicals used with John Deere equipment include such items as lubricants, coolants, paints, and adhesives.

A Material Safety Data Sheet (MSDS) provides specific details on chemical products: physical and health hazards, safety procedures, and emergency response techniques.

Check the MSDS before you start any job using a hazardous chemical. That way you will know exactly what the risks are and how to do the job safely. Then follow procedures and recommended equipment.

(See your John Deere dealer for MSDS's on chemical products used with John Deere equipment.)

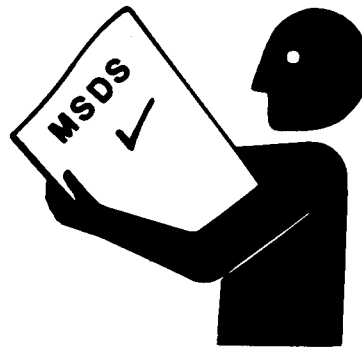

TS1132 -UN-26NOV90

DX,MSDS,NA -19-03MAR93-1/1

## Stay Clear of Rotating Drivelines

Entanglement in rotating driveline can cause serious injury or death.

Keep master shield and driveline shields in place at all times. Make sure rotating shields turn freely.

Wear close-fitting clothing. Stop the engine and be sure PTO driveline is stopped before making adjustments, connections, or performing any type of service on the engine or PTO-driven equipment.



Rotating Drivelines

TS1644 -UN-22AUG95

OUO1004,0000BD8 -19-11OCT06-1/1

## Practice Safe Maintenance

Understand service procedure before doing work. Keep area clean and dry.

Never lubricate, service, or adjust machine while it is moving. Keep hands, feet, and clothing from power-driven parts. Disengage all power and operate controls to relieve pressure. Lower equipment to the ground. Stop the engine. Remove the key. Allow machine to cool.

Securely support any machine elements that must be raised for service work.

Keep all parts in good condition and properly installed. Fix damage immediately. Replace worn or broken parts. Remove any buildup of grease, oil, or debris.

On self-propelled equipment, disconnect battery ground cable (-) before making adjustments on electrical systems or welding on machine.

On towed implements, disconnect wiring harnesses from tractor before servicing electrical system components or welding on machine.



TS218 -UN-23AUG88

DX,SERV -19-17FEB99-1/1

## Work In Ventilated Area

Engine exhaust fumes can cause sickness or death. If it is necessary to run an engine in an enclosed area, remove the exhaust fumes from the area with an exhaust pipe extension.

If you do not have an exhaust pipe extension, open the doors and get outside air into the area

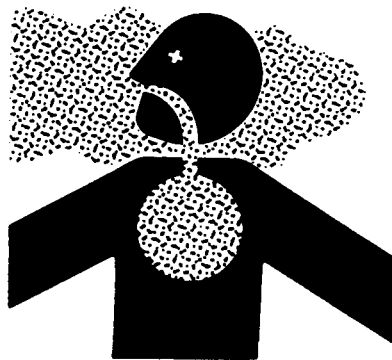

TS220 -UN-23AUG88

DX,AIR -19-17FEB99-1/1

## Avoid High-Pressure Fluids

Escaping fluid under pressure can penetrate the skin causing serious injury.

Avoid the hazard by relieving pressure before disconnecting hydraulic or other lines. Tighten all connections before applying pressure.

Search for leaks with a piece of cardboard. Protect hands and body from high pressure fluids.

If an accident occurs, see a doctor immediately. Any fluid injected into the skin must be surgically removed within a few hours or gangrene may result. Doctors unfamiliar with this type of injury should reference a knowledgeable medical source. Such information is available from Deere & Company Medical Department in Moline, Illinois, U.S.A.

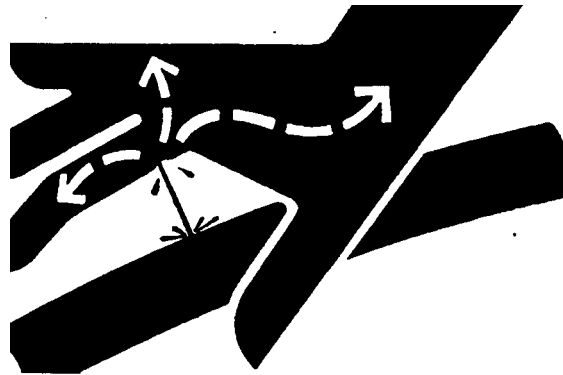

X9811 -UN-23AUG88

DX,FLUID -19-03MAR93-1/1

## Avoid Heating Near Pressurized Fluid Lines

Flammable spray can be generated by heating near pressurized fluid lines, resulting in severe burns to yourself and bystanders. Do not heat by welding, soldering, or using a torch near pressurized fluid lines or other flammable materials. Pressurized lines can accidentally burst when heat goes beyond the immediate flame area.



TS953 -UN-15MAY90

DX,TORCH -19-10DEC04-1/1

## Remove Paint Before Welding or Heating

Avoid potentially toxic fumes and dust.

Hazardous fumes can be generated when paint is heated by welding, soldering, or using a torch.

Remove paint before heating:

- Remove paint a minimum of 100 mm (4 in.) from area to be affected by heating. If paint cannot be removed, wear an approved respirator before heating or welding.
- If you sand or grind paint, avoid breathing the dust. Wear an approved respirator.
- If you use solvent or paint stripper, remove stripper with soap and water before welding. Remove solvent or paint stripper containers and other flammable material from area. Allow fumes to disperse at least 15 minutes before welding or heating.

Do not use a chlorinated solvent in areas where welding will take place.

Do all work in an area that is well ventilated to carry toxic fumes and dust away.

Dispose of paint and solvent properly.

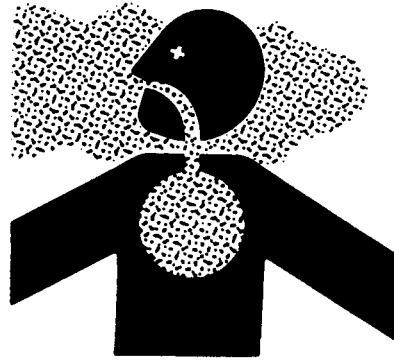

TS220 -UN-23AUG88

DX,PAINT -19-24JUL02-1/1

## Service Cooling System Safely

Explosive release of fluids from pressurized cooling system can cause serious burns.

Shut off engine. Only remove filler cap when cool enough to touch with bare hands. Slowly loosen cap to first stop to relieve pressure before removing completely.



TS281 -UN-23AUG88

DX,RCAP -19-04JUN90-1/1

### Install Fan Guards

Rotating cooling system fans can cause serious injury.

Keep fan guards in place at all times during engine operation. Wear close fitting clothes. Stop the engine and be sure fan is stopped before making adjustments or connections, or cleaning near the front of the engine.

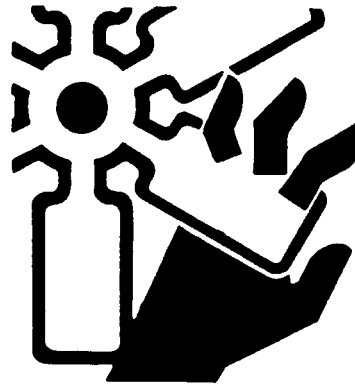

Rotating Fan

TS677 -JUN-21/SEP89

OUOD006,000009D -19-11OCT06-1/1

### Avoid Hot Parts

Avoid skin contact with exhaust manifolds, turbochargers and mufflers. Keep flammable materials clear of the turbocharger.

External dry exhaust parts become very hot during operation. Turbochargers may reach temperatures as high as 500°C (932°F) under full load, and naturally aspired exhaust manifolds may reach 600°C (1112°F) under full load. This may ignite paper, cloth or wooden materials. Parts on engines that have been at full load and reduced to no load idle will maintain approximately 150°C (302°F).

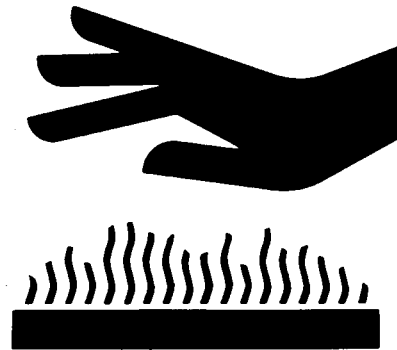

Hot Surface

TS271 -JUN-23/AUG88

OUOD006,000009E -19-04DEC02-1/1

## Avoid Harmful Asbestos Dust

Avoid breathing dust that may be generated when handling components containing asbestos fibers. Inhaled asbestos fibers may cause lung cancer.

Components in products that may contain asbestos fibers are brake pads, brake band and lining assemblies, clutch plates, and some gaskets. The asbestos used in these components is usually found in a resin or sealed in some way. Normal handling is not hazardous as long as airborne dust containing asbestos is not generated.

Avoid creating dust. Never use compressed air for cleaning. Avoid brushing or grinding material containing asbestos. When servicing, wear an approved respirator. A special vacuum cleaner is recommended to clean asbestos. If not available, apply a mist of oil or water on the material containing asbestos.

Keep bystanders away from the area.

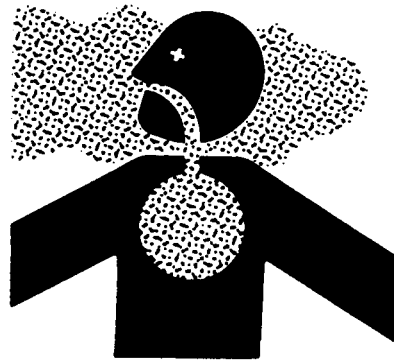

TS220 -JUN-23AUG88

DX,DUST -19-15MAR91-1/1

## Prevent Battery Explosions

Keep sparks, lighted matches, and open flame away from the top of battery. Battery gas can explode.

Never check battery charge by placing a metal object across the posts. Use a volt-meter or hydrometer.

Do not charge a frozen battery; it may explode. Warm battery to 16°C (60°F).



TS204 -JUN-23AUG88

DX,SPARKS -19-03MAR93-1/1

## Handling Batteries Safely

**CAUTION:** Battery gas can explode. Keep sparks and flames away from batteries. Use a flashlight to check battery electrolyte level.

Never check battery charge by placing a metal object across the posts. Use a voltmeter or hydrometer.

Always remove grounded (—) battery clamp first and replace it last.

**CAUTION:** Sulfuric acid in battery electrolyte is poisonous. It is strong enough to burn skin, eat holes in clothing, and cause blindness if splashed into eyes.

Avoid the hazard by:

1. Filling batteries in a well-ventilated area.
2. Wearing eye protection and rubber gloves.
3. Avoiding breathing fumes when electrolyte is added.
4. Avoiding spilling or dripping electrolyte.
5. Using proper jump start procedure.

If you spill acid on yourself:

1. Flush your skin with water.
2. Apply baking soda or lime to help neutralize the acid.
3. Flush your eyes with water for 15—30 minutes. Get medical attention immediately.

If acid is swallowed:

1. Do not induce vomiting.
2. Drink large amounts of water or milk, but do not exceed 2 L (2 qt.).
3. Get medical attention immediately.

**WARNING:** Battery posts, terminals, and related accessories contain lead and lead compounds, chemicals known to the State of California to cause cancer and reproductive harm. **Wash hands after handling.**



Explosion

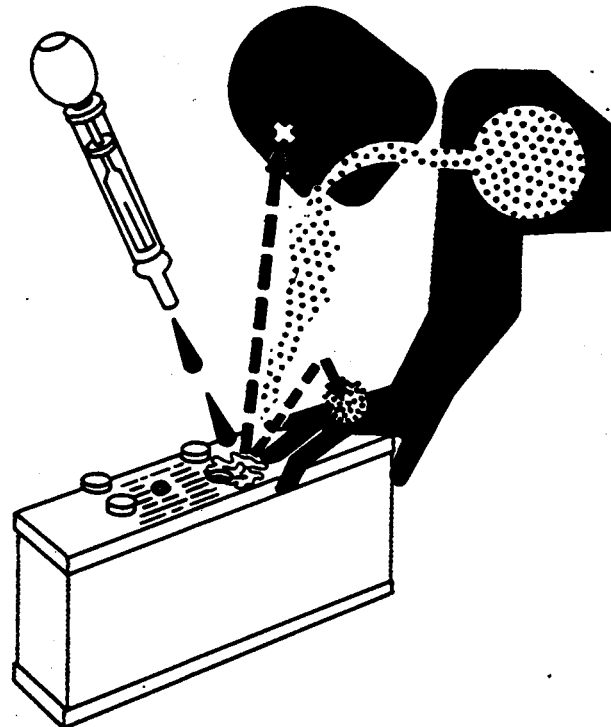

Acid

TS204 -JUN-23AUG88

TS203 -JUN-23AUG88



### Protect Against High Pressure Spray

Spray from high pressure nozzles can penetrate the skin and cause serious injury. Keep spray from contacting hands or body.

If an accident occurs, see a doctor immediately. Any high pressure spray injected into the skin must be surgically removed within a few hours or gangrene may result. Doctors unfamiliar with this type of injury should reference a knowledgeable medical source. Such information is available from Deere & Company Medical Department in Moline, Illinois, U.S.A.



TS1343 -UN-18MAR92

DX,SPRAY -19-16APR92-1/1

### Use Proper Lifting Equipment

Lifting heavy components incorrectly can cause severe injury or machine damage.

Follow recommended procedure for removal and installation of components in the manual.

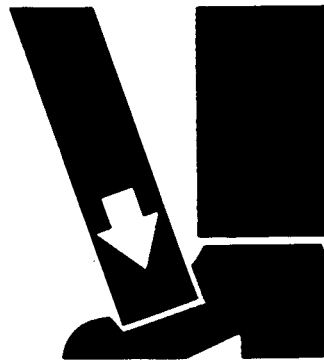

TS226 -UN-23AUG88

DX,LIFT -19-04JUN90-1/1

### Use Proper Tools

Use tools appropriate to the work. Makeshift tools and procedures can create safety hazards.

Use power tools only to loosen threaded parts and fasteners.

For loosening and tightening hardware, use the correct size tools. DO NOT use U.S. measurement tools on metric fasteners. Avoid bodily injury caused by slipping wrenches.

Use only service parts meeting John Deere specifications.



TS779 -UN-08NOV89

DX,REPAIR -19-17FEB99-1/1

## Dispose of Waste Properly

Improperly disposing of waste can threaten the environment and ecology. Potentially harmful waste used with John Deere equipment include such items as oil, fuel, coolant, brake fluid, filters, and batteries.

Use leakproof containers when draining fluids. Do not use food or beverage containers that may mislead someone into drinking from them.

Do not pour waste onto the ground, down a drain, or into any water source.

Air conditioning refrigerants escaping into the air can damage the Earth's atmosphere. Government regulations may require a certified air conditioning service center to recover and recycle used air conditioning refrigerants.

Inquire on the proper way to recycle or dispose of waste from your local environmental or recycling center, or from your John Deere dealer.

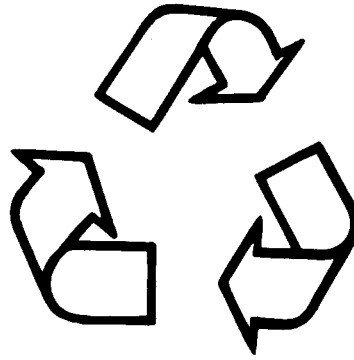

T51133 -UN-26NOV90

DX,DRAIN -19-03MAR93-1/1

# Fuels, Lubricants, and Coolant

## Diesel Fuel

Consult your local fuel distributor for properties of the diesel fuel available in your area.

In general, diesel fuels are blended to satisfy the low temperature requirements of the geographical area in which they are marketed.

Diesel fuels specified to EN 590 or ASTM D975 are recommended.

### Required fuel properties

In all cases, the fuel shall meet the following properties:

**Cetane number of 45 minimum.** Cetane number greater than 50 is preferred, especially for temperatures below -20°C (-4°F) or elevations above 1500 m (5000 ft).

**Cold Filter Plugging Point (CFPP)** below the expected low temperature OR **Cloud Point** at least 5°C (9°F) below the expected low temperature.

**Fuel lubricity** should pass a minimum level of 3100 grams as measured by ASTM D6078 or maximum

scar diameter of 0.45 mm as measured by ASTM D6079 or ISO 12156-1.

### Sulfur content:

- Diesel fuel quality and fuel sulfur content must comply with all existing emissions regulations for the area in which the engine operates.
- Use of diesel fuel with sulfur content less than 0.10% (1000 ppm) is **STRONGLY** recommended.
- Use of diesel fuel with sulfur content 0.10% (1000 ppm) to 0.50% (5000 ppm) may result in **REDUCED** oil and filter change intervals.
- **BEFORE** using diesel fuel with sulfur content greater than 0.50% (5000 ppm), contact your John Deere dealer.
- **DO NOT** use diesel fuel with sulfur content greater than 1.0%.

**IMPORTANT: Do not mix used diesel engine oil or any other type of lubricating oil with diesel fuel.**

**IMPORTANT: Improper fuel additive usage may cause damage on fuel injection equipment of diesel engines.**

DX,FUEL1 -19-17NOV05-1/1

## Lubricity of Diesel Fuel

Most diesel fuels manufactured in the United States, Canada, and the European Union have adequate lubricity to ensure proper operation and durability of fuel injection system components. However, diesel fuels manufactured in some areas of the world may lack the necessary lubricity.

**IMPORTANT: Make sure the diesel fuel used in your machine demonstrates good lubricity characteristics.**

Fuel lubricity should pass a minimum load level of 3100 grams as measured by ASTM D6078 or a maximum scar diameter of 0.45 mm as measured by ASTM D6079 or ISO 12156-1.

If fuel of low or unknown lubricity is used, add John Deere **PREMIUM DIESEL FUEL CONDITIONER** (or equivalent) at the specified concentration.

DX,FUEL5 -19-27OCT05-1/1

## Handling and Storing Diesel Fuel



**CAUTION:** Handle fuel carefully. Do not fill the fuel tank when engine is running.

**DO NOT smoke while you fill the fuel tank or service the fuel system.**

Fill the fuel tank at the end of each day's operation to prevent water condensation and freezing during cold weather.

Keep all storage tanks as full as practicable to minimize condensation.

Ensure that all fuel tank caps and covers are installed properly to prevent moisture from entering.

Monitor water content of the fuel regularly.

When using bio-diesel fuel, the fuel filter may require more frequent replacement due to premature plugging.

Check engine oil level daily prior to starting engine. A rising oil level may indicate fuel dilution of the engine oil.

**IMPORTANT:** The fuel tank is vented through the filler cap. If a new filler cap is required, always replace it with an original vented cap.

When fuel is stored for an extended period or if there is a slow turnover of fuel, add a fuel conditioner to stabilize the fuel and prevent water condensation. Contact your fuel supplier for recommendations.

DX,FUEL4 -19-19DEC03-1/1

## Testing Diesel Fuel

DIESELSCAN™ is a John Deere fuel analysis program that can be used to monitor the quality of your fuel. The DIESELSCAN analysis verifies fuel type, cleanliness, water content, suitability for cold weather operation, and whether the fuel meets specifications.

Check with your John Deere dealer for availability of DIESELSCAN kits.

*DIESELSCAN is a trademark of Deere & Company*

DX,FUEL6 -19-14NOV05-1/1

## Bio-Diesel Fuel

Consult your local fuel distributor for properties of the bio-diesel fuel available in your area.

Bio-diesel fuels may be used ONLY if the bio-diesel fuel properties meet the latest edition of ASTM D6751, EN 14214, or equivalent specification.

It is recommended to purchase bio-diesel fuel blended with B100 from a BQ-9000 Accredited Producer or a BQ-9000 Certified Marketer as recommended by the National Bio-diesel Board.

The maximum allowable bio-diesel concentration is a 5% blend (also known as B5) in petroleum diesel fuel. It has been found that bio-diesel fuels may improve lubricity in concentrations up to this 5% blend.

When using a blend of bio-diesel fuel, the engine oil level must be checked daily when the air temperature is  $-10^{\circ}\text{C}$  ( $14^{\circ}\text{F}$ ) or lower. If oil becomes diluted with fuel, shorten oil change intervals accordingly.

**IMPORTANT: Raw pressed vegetable oils are NOT acceptable for use as fuel in any concentration in John Deere engines.**

**These oils do not burn completely, and will cause engine failure by**

**leaving deposits on injectors and in the combustion chamber.**

A major environmental benefit of bio-diesel fuel is its ability to biodegrade. This makes proper storage and handling of bio-diesel fuel especially important. Areas of concern include:

- Quality of new fuel
- Water content of the fuel
- Problems due to aging of the fuel

Potential problems resulting from deficiencies in the above areas when using bio-diesel fuel in concentrations above 5% may lead to the following symptoms:

- Power loss and deterioration of performance
- Fuel leakage
- Corrosion of fuel injection equipment
- Coked and/or blocked injector nozzles, resulting in engine misfire
- Filter plugging
- Lacquering and/or seizure of internal components
- Sludge and sediments
- Reduced service life of engine components

Consult your fuel supplier for additives to improve storage and performance of bio-diesel fuels.

DX,FUEL7 -19-14NOV05-1/1

## Aviation (Jet) Fuels

Aviation (jet) fuels may be used with the following restrictions.

Type	Comments
Jet A	Lower viscosity and density than base No. 2-D diesel fuel. Power loss up to 10% can be expected.
Jet A-1	Lower viscosity and density than base No. 2-D diesel fuel. Power loss up to 10% can be expected.
Jet B	<b>Not Recommended.</b> Lower density and extremely low viscosity compared to base No. 2-D diesel fuel. Power loss up to 14% can be expected.
JP-4	<b>Not Recommended.</b> Lower density and extremely low viscosity compared to base No. 2-D diesel fuel. Power loss up to 12% can be expected.
JP-5	Lower viscosity and density than base No. 2-D diesel fuel. Power loss up to 9% can be expected.
JP-7	Lower viscosity and density than base No. 2-D diesel fuel. Power loss up to 10% can be expected.
JP-8	Lower viscosity and density than base No. 2-D diesel fuel. Power loss up to 10% can be expected.

OURGP12,000003F -19-07JUL04-1/1

## Burner Fuels

Burner fuels, like kerosene, may be used with the following restrictions.

Type	Comments
No.2	Higher density and specific gravity than base No. 2-D diesel fuel. Power increase up to 3% can be expected.
No.1	Lower viscosity than base No. 2-D diesel fuel. Power loss up to 2% can be expected.

OURGP12,0000040 -19-07JUL04-1/1

## Minimizing the Effect of Cold Weather on Diesel Engines

John Deere diesel engines are designed to operate effectively in cold weather.

However, for effective starting and cold weather operation, a little extra care is necessary. The information below outlines steps that can minimize the effect that cold weather may have on starting and operation of your engine. See your John Deere dealer for additional information and local availability of cold weather aids

### Use Winter Grade Fuel

When temperatures fall below 5°C (40°F), winter grade fuel (Grade No. 1-D fuel in North America) is best suited for cold weather operation. Winter grade fuel has a lower cloud point and a lower pour point.

**Cloud point** is the temperature at which wax will begin to form in the fuel and this wax causes fuel filters to plug. **Pour point** is the temperature at which fuel begins to thicken and becomes more resistant to flow through fuel pumps and lines.

*NOTE: On an average, winter grade fuel has a lower BTU (heat content) rating. Using winter grade fuel may reduce power and fuel efficiency, but should not cause any other engine performance effects. Check the grade of fuel being used before troubleshooting for low power complaints in cold weather operation.*

### Air Intake Heater

An air intake heater is an available option to aid cold weather starting.



**CAUTION: Do not use any starting fluid with an air intake heater.**

### Starting Fluid

A starting fluid port on the intake is available to aid cold weather starting.



**CAUTION: Do not use any starting fluid with an engine equipped with glow plugs**

### Coolant Heater

An engine block heater (coolant heater) is an available option to aid cold weather starting.

### Seasonal Viscosity Oil and Proper Coolant Concentration

Use seasonal grade viscosity engine oil based on the expected air temperature range between oil changes and proper concentration of low silicate antifreeze as recommended. (See DIESEL ENGINE OIL and ENGINE COOLANT requirements this section.)

### Diesel Fuel Flow Additive

Use John Deere Premium Diesel Fuel Conditioner (Winter) or equivalent to treat fuel during the cold weather season. This winter formulation is a combination diesel fuel conditioner and anti-gel additive.

**IMPORTANT: Treat fuel when outside temperature drops below 0°C (32°F). For best results, use with untreated fuel. Follow all recommended instructions on label.**

### Winterfronts

Use of fabric, cardboard, or solid winterfronts is not recommended with any John Deere engine. Their use can result in excessive engine coolant, oil, and charge air temperatures. This can lead to reduced engine life, loss of power and poor fuel economy. Winterfronts may also put abnormal stress on fan and fan drive components potentially causing premature failures.

Continued on next page

DX,FUEL10 -19-16DEC05-1/2

If winterfronts are used, they should never totally close off the grill frontal area. Approximately 25% area in the center of the grill should remain open at all times. At no time should the air blockage device be applied directly to the radiator core.

### Radiator Shutters

If equipped with a thermostatically controlled radiator shutter system, this system should be regulated in such a way that the shutters are completely open by

the time the coolant reaches 93°C (200°F) to prevent excessive intake manifold temperatures. Manually controlled systems are not recommended.

If air-to-air aftercooling is used, the shutters must be completely open by the time the intake manifold air temperature reaches the maximum allowable temperature out of the charge air cooler.

For more information, see your John Deere dealer.

DX,FUEL10 -19-16DEC05-2/2

## Diesel Engine Break-In Oil

New engines are filled at the factory with John Deere ENGINE BREAK-IN OIL. During the break-in period, add John Deere ENGINE BREAK-IN OIL as needed to maintain the specified oil level.

Change the oil and filter after the first 100 hours of operation of a new or rebuilt engine.

After engine overhaul, fill the engine with John Deere ENGINE BREAK-IN OIL.

If John Deere ENGINE BREAK-IN OIL is not available, use a diesel engine oil meeting one of the following during the first 100 hours of operation:

- API Service Classification CE
- API Service Classification CD
- API Service Classification CC
- ACEA Oil Sequence E2
- ACEA Oil Sequence E1

After the break-in period, use John Deere PLUS-50™ or other diesel engine oil as recommended in this manual.

**IMPORTANT: Do not use PLUS-50 oil or engine oils meeting any of the following during the first 100 hours of operation of a new or rebuilt engine:**

API CJ-4	ACEA E7
API CI-4 PLUS	ACEA E6
API CI-4	ACEA E5
API CH-4	ACEA E4
API CG-4	ACEA E3
API CF-4	
API CF-2	
API CF	

**These oils will not allow the engine to break-in properly.**

PLUS-50 is a trademark of Deere & Company.

DX,ENOIL4 -19-13SEP06-1/1



## Diesel Engine Oil

Use oil viscosity based on the expected air temperature range during the period between oil changes.

### John Deere PLUS-50™ oil is preferred.

Oils meeting one of the following specifications are also recommended:

- ACEA Oil Sequence E7
- ACEA Oil Sequence E6
- ACEA Oil Sequence E5
- ACEA Oil Sequence E4

Extended service intervals may apply when John Deere PLUS-50, ACEA E7, ACEA E6, ACEA E5, or ACEA E4 engine oils are used. Consult your John Deere dealer for more information.

Other oils may be used if they meet one or more of the following:

- John Deere TORQ-GARD SUPREME™
- API Service Category CJ-4
- API Service Category CI-4 PLUS
- API Service Category CI-4
- API Service Category CH-4
- API Service Category CG-4
- API Service Category CF-4
- ACEA Oil Sequence E3
- ACEA Oil Sequence E2

If oils meeting API CG-4, API CF-4, or ACEA E2 are used, reduce the service interval by 50%.

### Multi-viscosity diesel engine oils are preferred.

Diesel fuel quality and fuel sulfur content must comply with all existing emissions regulations for the area in which the engine operates.

If diesel fuel with sulfur content greater than 0.50% (5000 ppm) is used, reduce the service interval by 50%.

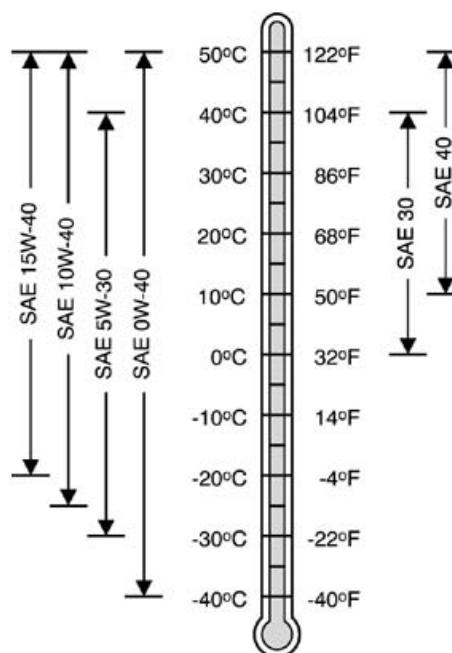

Oil Viscosities for Air Temperature Ranges

TS1681 -JUN-09OCT06

PLUS-50 is a trademark of Deere & Company

TORQ-GARD SUPREME is a trademark of Deere & Company

Continued on next page

DX,ENOIL -19-13SEP06-1/2

DO NOT use diesel fuel with sulfur content greater than 1.00% (10 000 ppm).

DX,ENOIL -19-13SEP06-2/2

## Extended Diesel Engine Oil Service Intervals

When John Deere PLUS-50™ oil is used with the specified John Deere filter, the service interval for engine oil and filter changes may be increased by 50% but not to exceed a maximum of 500 hours.

When ACEA E7, ACEA E6, ACEA E5, or ACEA E4 oils are used with specified John Deere filter, use engine oil analysis to determine if the service interval for engine oil and filter changes may be increased by a maximum of 50% but not to exceed 500 hours.

If John Deere PLUS-50™, ACEA E7, ACEA E6, ACEA E5, or ACEA E4 oils are used with other than the

specified John Deere filter, change the engine oil and filter at the normal service interval.

If John Deere TORQ-GARD SUPREME™, API CJ-4, API CI-4 PLUS, API CI-4, API CH-4, or ACEA E3 oils are used, change the engine oil and filter at the normal service interval.

If API CG-4, API CF-4, or ACEA E2 oils are used, change the engine oil and filter at 50% of the normal service interval.

*PLUS-50 is a trademark of Deere & Company  
TORQ-GARD SUPREME is a trademark of Deere & Company*

DX,ENOIL6 -19-13SEP06-1/1

## Mixing of Lubricants

In general, avoid mixing different brands or types of oil. Oil manufacturers blend additives in their oils to meet certain specifications and performance requirements.

Mixing different oils can interfere with the proper functioning of these additives and degrade lubricant performance.

Consult your John Deere dealer to obtain specific information and recommendations.

DX,LUBMIX -19-18MAR96-1/1

## OILSCAN™ and COOLSCAN™

OILSCAN™ and COOLSCAN™ are John Deere sampling programs to help you monitor machine performance and identify potential problems before they cause serious damage.

Oil and coolant samples should be taken from each system prior to its recommended change interval.

Check with your John Deere dealer for the availability of OILSCAN™ and COOLSCAN™ kits.

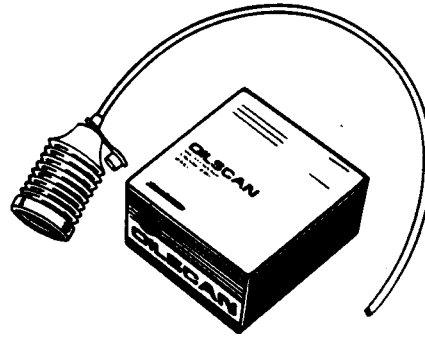

T6828AB -JUN-15JUN89

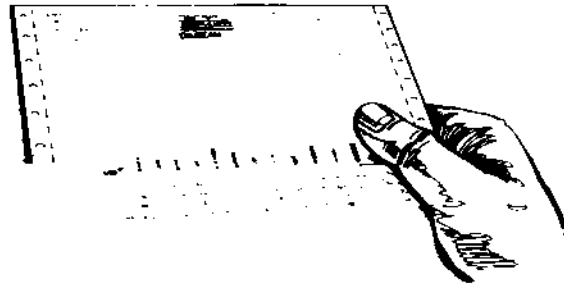

T6829AB -JUN-18OCT88

*OILSCAN is a registered trademark of Deere & Company.  
COOLSCAN is a trademark of Deere & Company.*

DX,OILSCAN -19-02DEC02-1/1

## Alternative and Synthetic Lubricants

Conditions in certain geographical areas may require lubricant recommendations different from those printed in this manual.

Some John Deere brand coolants and lubricants may not be available in your location.

Consult your John Deere dealer to obtain information and recommendations.

Synthetic lubricants may be used if they meet the performance requirements as shown in this manual.

The temperature limits and service intervals shown in this manual apply to both conventional and synthetic oils.

Re-refined base stock products may be used if the finished lubricant meets the performance requirements.

DX,ALTER -19-15JUN00-1/1

## **Lubricant Storage**

Your equipment can operate at top efficiency only when clean lubricants are used.

Use clean containers to handle all lubricants.

Whenever possible, store lubricants and containers in an area protected from dust, moisture, and other contamination. Store containers on their side to avoid water and dirt accumulation.

Make certain that all containers are properly marked to identify their contents.

Properly dispose of all old containers and any residual lubricant they may contain.

DX,LUBST -19-18MAR96-1/1

## **Oil Filters**

Filtration of oils is critical to proper operation and lubrication.

Always change filters regularly as specified in this manual.

Use filters meeting John Deere performance specifications.

DX,FILT -19-18MAR96-1/1

## Grease

Use grease based on NLGI consistency numbers and the expected air temperature range during the service interval.

**John Deere SD POLYUREA GREASE is preferred.**

The following greases are also recommended

- John Deere HD LITHIUM COMPLEX GREASE
- John Deere HD WATER RESISTANT GREASE
- John Deere GREASE-GARD™

Other greases may be used if they meet the following:

NLGI Performance Classification GC-LB

**IMPORTANT: Some types of grease thickeners are not compatible with others. Consult your grease supplier before mixing different types of grease**

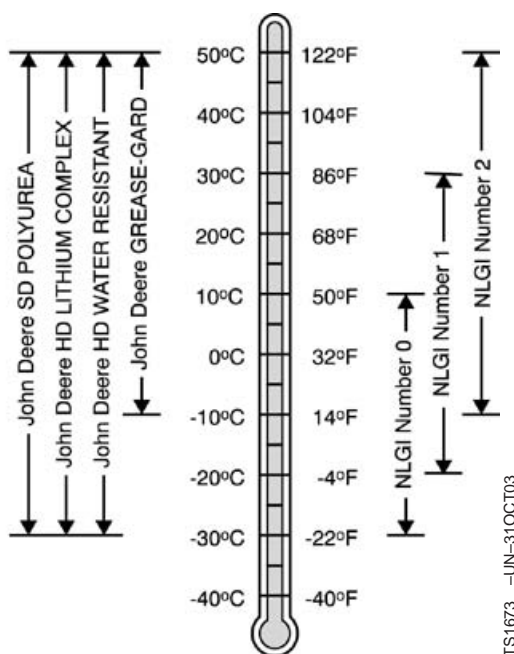

*GREASE-GARD is a trademark of Deere & Company*

DX,GREA1 -19-07NOV03-1/1

## Diesel Engine Coolant

The engine cooling system is filled to provide year-round protection against corrosion and cylinder liner pitting, and winter freeze protection to -37°C (-34°F). If protection at lower temperatures is required, consult your John Deere dealer for recommendations.

**John Deere COOL-GARD™ Prediluted Coolant is preferred for service.**

John Deere COOL-GARD Prediluted Coolant is available in a concentration of either 50% ethylene glycol or 55% propylene glycol.

### Additional recommended coolants

The following engine coolant is also recommended:

- John Deere COOL-GARD Coolant Concentrate in a 40% to 60% mixture of concentrate with quality water.

John Deere COOL-GARD coolants do not require use of supplemental coolant additives, except for periodic replenishment of additives during the drain interval.

### Other fully formulated coolants

Other fully formulated low silicate ethylene or propylene glycol base coolants for heavy-duty engines may be used if they meet one of the following specifications:

- ASTM D6210 prediluted (50%) coolant
- ASTM D6210 coolant concentrate in a 40% to 60% mixture of concentrate with quality water

Coolants meeting ASTM D6210 do not require use of supplemental coolant additives, except for periodic replenishment of additives during the drain interval.

### Coolants requiring supplemental coolant additives

Other low silicate ethylene glycol base coolants for heavy-duty engines may also be used if they meet one of the following specifications:

- ASTM D4985 ethylene glycol base prediluted (50%) coolant
- ASTM D4985 ethylene glycol base coolant concentrate in a 40% to 60% mixture of concentrate with quality water

Coolants meeting ASTM D4985 require an initial charge of supplemental coolant additives, formulated for protection of heavy duty diesel engines against corrosion and cylinder liner erosion and pitting. They also require periodic replenishment of additives during the drain interval.

### Other coolants

It is possible that neither John Deere COOL-GARD nor coolants meeting one of the coolant standards listed above is available in the geographical area where service is performed. If these coolants are unavailable, use a coolant concentrate or prediluted coolant with a quality additive package that provides cylinder liner cavitation protection and protects the cooling system metals (cast iron, aluminum alloys, and copper alloys such as brass) from corrosion.

The additive package must be part of one of the following coolant mixtures:

- ethylene glycol or propylene glycol base prediluted (40% to 60%) coolant
- ethylene glycol or propylene glycol base coolant concentrate in a 40% to 60% mixture of concentrate with quality water

### Water quality

Water quality is important to the performance of the cooling system. Distilled, deionized, or demineralized water is recommended for mixing with ethylene glycol and propylene glycol base engine coolant concentrate.

**IMPORTANT: Do not mix ethylene glycol and propylene glycol base coolants.**

**IMPORTANT: Do not use cooling system sealing additives or antifreeze that contains sealing additives.**

DX,COOL3 -19-27OCT05-2/2

## Drain Intervals for Diesel Engine Coolant

Drain the factory fill engine coolant, flush the cooling system, and refill with new coolant after the first 3 years or 3000 hours of operation.

Subsequent drain intervals are determined by the coolant used for service. At each interval, drain the coolant, flush the cooling system, and refill with new coolant.

When John Deere COOL-GARD™ is used, the drain interval may be extended to 5 years or 5000 hours of operation, provided that the coolant is tested annually AND additives are replenished, as needed, by adding a supplemental coolant additive.

If John Deere COOL-GARD is used but the coolant is not tested OR additives are not replenished by adding a supplemental coolant additive, the drain interval is 3 years or 3000 hours of operation

If COOL-GARD is not used, the drain interval is reduced to 2 years or 2000 hours of operation.

*COOL-GARD is a trademark of Deere & Company*

DX,COOL11 -19-19DEC03-1/1

## Additional Information About Diesel Engine Coolants and Supplemental Coolant Additives

Engine coolants are a combination of three chemical components: ethylene glycol or propylene glycol antifreeze, inhibiting coolant additives, and quality water.

### Coolant specifications

Some products, including John Deere COOL-GARD™ Prediluted Coolant, are fully formulated coolants that contain all three components in their correct concentrations. Do not add an initial charge of supplemental coolant additives to these fully formulated products.

Coolants meeting ASTM D6210 do not require an initial charge of supplemental coolant additives.

Some coolant concentrates, including John Deere COOL-GARD Coolant Concentrate, contain both glycol antifreeze and inhibiting coolant additives. Mix these products with quality water, but do not add an initial charge of supplemental coolant additives.

Coolants meeting ASTM D4985 require an initial charge of supplemental coolant additives.

### Replenish coolant additives

The concentration of coolant additives is gradually depleted during engine operation. Periodic replenishment of inhibitors is required, even when John Deere COOL-GARD or another fully formulated coolant is used. Follow the recommendations in this manual for the use of supplemental coolant additives.

### Why use supplemental coolant additives?

Operating without proper coolant additives will result in increased corrosion, cylinder liner erosion and pitting, and other damage to the engine and cooling system. A

simple mixture of ethylene glycol or propylene glycol and water will not give adequate protection.

Use of supplemental coolant additives reduces corrosion, erosion, and pitting. These chemicals reduce the number of vapor bubbles in the coolant and help form a protective film on cylinder liner surfaces. This film acts as a barrier against the harmful effects of collapsing vapor bubbles.

### Avoid automotive-type coolants

Never use automotive-type coolants (such as those meeting ASTM D3306). These coolants do not contain the correct additives to protect heavy-duty diesel engines. They often contain a high concentration of silicates and may damage the engine or cooling system.

### Water quality

Water quality is important to the performance of the cooling system. Distilled, deionized, or demineralized water is recommended for mixing with ethylene glycol and propylene glycol base engine coolant concentrate. All water used in the cooling system should meet the following minimum specifications for quality:

Chlorides	<40 mg/L
Sulfates	<100 mg/L
Total dissolved solids	<340 mg/L
Total hardness	<170 mg/L
pH	5.5 to 9.0

### Freeze protection

The relative concentrations of glycol and water in the engine coolant determine its freeze protection limit.



Ethylene Glycol	Freeze Protection Limit
40%	-24°C (-12°F)
50%	-37°C (-34°F)
60%	-52°C (-62°F)
Propylene Glycol	Freeze Protection Limit
40%	-21°C (-6°F)
50%	-33°C (-27°F)
60%	-49°C (-56°F)

DO NOT use a coolant-water mixture greater than 60% ethylene glycol or 60% propylene glycol.

DX,COOL7 -19-19DEC03-2/2

## Supplemental Coolant Additives

The concentration of coolant additives is gradually depleted during engine operation. For all recommended coolants, replenish additives between drain intervals by adding a supplemental coolant additive every 12 months or as determined necessary by coolant testing.

John Deere COOLANT CONDITIONER is recommended as a supplemental coolant additive in John Deere engines.

**IMPORTANT: Do not add a supplemental coolant additive when the cooling system is drained and refilled with John DeereCOOL-GARD™.**

If other coolants are used, consult the coolant supplier and follow the manufacturer's recommendation for use of supplemental coolant additives.

The use of non-recommended supplemental coolant additives may result in additive drop-out and gelation of the coolant.

Add the manufacturer's recommended concentration of supplemental coolant additive. DO NOT add more than the recommended amount.

COOL-GARD is a trademark of Deere & Company

DX,COOL4 -19-07NOV03-1/1

## Additional Information About Diesel Engine Coolants and Supplemental Coolant Additives

Engine coolants are a combination of three chemical components: ethylene glycol or propylene glycol antifreeze, inhibiting coolant additives, and quality water.

### Coolant specifications

Some products, including John Deere COOL-GARD™ Prediluted Coolant, are fully formulated coolants that contain all three components in their correct concentrations. Do not add an initial charge of supplemental coolant additives to these fully formulated products.

Coolants meeting ASTM D6210 do not require an initial charge of supplemental coolant additives.

Some coolant concentrates, including John Deere COOL-GARD Coolant Concentrate, contain both glycol antifreeze and inhibiting coolant additives. Mix these products with quality water, but do not add an initial charge of supplemental coolant additives.

Coolants meeting ASTM D4985 require an initial charge of supplemental coolant additives.

### Replenish coolant additives

The concentration of coolant additives is gradually depleted during engine operation. Periodic replenishment of inhibitors is required, even when John Deere COOL-GARD or another fully formulated coolant is used. Follow the recommendations in this manual for the use of supplemental coolant additives.

### Why use supplemental coolant additives?

Operating without proper coolant additives will result in increased corrosion, cylinder liner erosion and pitting, and other damage to the engine and cooling system. A

simple mixture of ethylene glycol or propylene glycol and water will not give adequate protection.

Use of supplemental coolant additives reduces corrosion, erosion, and pitting. These chemicals reduce the number of vapor bubbles in the coolant and help form a protective film on cylinder liner surfaces. This film acts as a barrier against the harmful effects of collapsing vapor bubbles.

### Avoid automotive-type coolants

Never use automotive-type coolants (such as those meeting ASTM D3306). These coolants do not contain the correct additives to protect heavy-duty diesel engines. They often contain a high concentration of silicates and may damage the engine or cooling system.

### Water quality

Water quality is important to the performance of the cooling system. Distilled, deionized, or demineralized water is recommended for mixing with ethylene glycol and propylene glycol base engine coolant concentrate. All water used in the cooling system should meet the following minimum specifications for quality:

Chlorides	<40 mg/L
Sulfates	<100 mg/L
Total dissolved solids	<340 mg/L
Total hardness	<170 mg/L
pH	5.5 to 9.0

### Freeze protection

The relative concentrations of glycol and water in the engine coolant determine its freeze protection limit.

Ethylene Glycol	Freeze Protection Limit
40%	-24°C (-12°F)
50%	-37°C (-34°F)
60%	-52°C (-62°F)
Propylene Glycol	Freeze Protection Limit
40%	-21°C (-6°F)
50%	-33°C (-27°F)
60%	-49°C (-56°F)

DO NOT use a coolant-water mixture greater than 60% ethylene glycol or 60% propylene glycol.

DX.COOL7 -19-19DEC03-2/2

## Testing Diesel Engine Coolant

### Testing Diesel Engine Coolant

Maintaining adequate concentrations of glycol and inhibiting additives in the coolant is critical to protect the engine and cooling system against freezing, corrosion, and cylinder liner erosion and pitting.

Test the coolant solution at intervals of 12 months or less and whenever excessive coolant is lost through leaks or overheating.

### Coolant test strips

Coolant test strips are available from your John Deere dealer. These test strips provide a simple, effective

method to check the freeze point and additive levels of your engine coolant.

Compare the results to the supplemental coolant additive (SCA) chart to determine the amount of inhibiting additives in your coolant and whether more John Deere COOLANT CONDITIONER should be added.

### COOLSCAN™ and COOLSCAN PLUS™

For a more thorough evaluation of your coolant, perform a COOLSCAN or COOLSCAN PLUS analysis, where available. See your John Deere dealer for information.

*COOLSCAN is a trademark of Deere & Company*  
*COOLSCAN PLUS is a trademark of Deere & Company*

DX.COOL9 -19-19DEC03-1/1

## Operating in Warm Temperature Climates

John Deere engines are designed to operate using glycol base engine coolants.

Always use a recommended glycol base engine coolant, even when operating in geographical areas where freeze protection is not required.

**IMPORTANT:** Water may be used as coolant *in emergency situations only.*

**Foaming, hot surface aluminum and iron corrosion, scaling, and cavitation will occur when water is used as the coolant, even when coolant conditioners are added.**

**Drain cooling system and refill with recommended glycol base engine coolant as soon as possible.**

DX,COOL6 -19-18MAR96-1/1

## Disposing of Coolant

Improperly disposing of engine coolant can threaten the environment and ecology.

Use leakproof containers when draining fluids. Do not use food or beverage containers that may mislead someone into drinking from them.

Do not pour waste onto the ground, down a drain, or into any water source.

Inquire on the proper way to recycle or dispose of waste from your local environmental or recycling center, or from your John Deere engine distributor or servicing dealer.

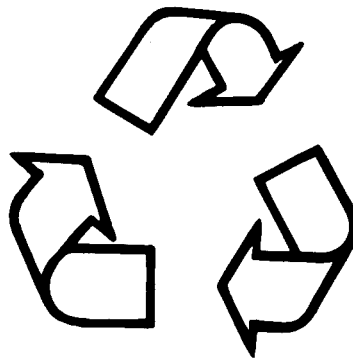

Recycle Waste

TS1133 -UN-26NOV90

RG,RG34710,7543 -19-11OCT06-1/1

# Engine Operating Guidelines

## Instrument (Gauge) Panels

All controls and gauges are optional equipment for John Deere OEM Engines. They may be provided by the equipment manufacturer instead of John Deere. The following information applies only to those controls and gauges provided by John Deere.

**IMPORTANT:** Any time an electric gauge or meter does not register correctly, replace it with a new one. Do not attempt to repair it.

Two types of instrument panels are offered on 4.5 L and 6.8 L engines, as shown on this page. See following for complete information on each type of instrument panel.



*North American Instrument Panel*

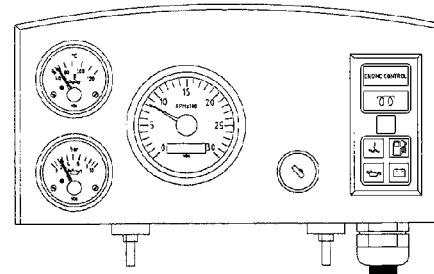

*VDO Instrument Panel (Except North America)*

RG11299 -UN-12SEP00

RG10606A -UN-19JUN00

DPSG, RG34710, 107 -19-10JAN02-1/1

## Instrument (Gauge) Panel (North America)

All controls and gauges are optional equipment for John Deere OEM Engines. They may be provided by the equipment manufacturer instead of John Deere. The following information applies only to those controls and gauges provided by John Deere.

**IMPORTANT:** Any time an electric gauge or meter does not register correctly, replace it with a new one. Do not attempt to repair it.

Following is a brief description of the components on the instrument (gauge) panel:

**A—Oil Pressure Gauge** - This gauge indicates oil pressure. It also has an adjustable electrical contact which activates the safety switch when oil pressure goes below the pressure set point. This will automatically stop the engine.

**B—Coolant Temperature Gauge** - This gauge indicates coolant temperature. It also has an electrical contact which activates the safety switch when coolant temperature goes above the temperature set point. This will automatically stop the engine.

**C—Key Switch** - The key switch is used to start and stop the engine. A key is required to operate the switch so as to prevent unauthorized operation of the engine.

**D—Tachometer** - The tachometer indicates engine speed in hundreds of revolutions per minute (rpm).

**E—Safety Switch (Reset Button)** - The safety switch de-energizes the fuel shut-off solenoid or injection rack puller to stop the engine, if one or more conditions are met:

- Low or no oil pressure
- High coolant temperature
- Low crankcase oil level (if equipped with engine oil level switch)
- High crankcase oil level (if equipped with engine oil level switch)

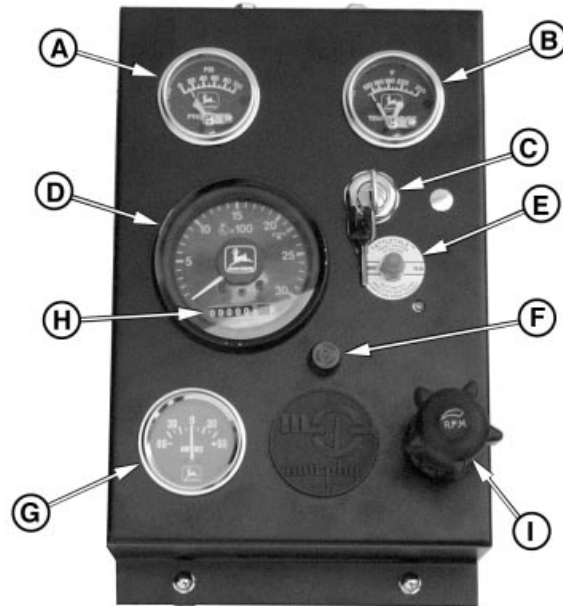

North American Instrument Panel

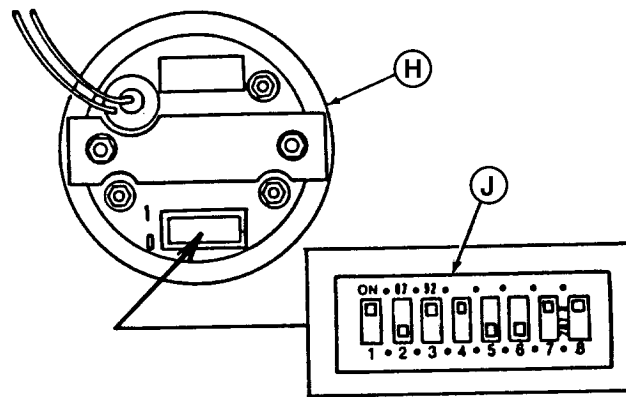

Hour Meter And Tachometer Codes

- A—Oil Pressure Gauge
- B—Coolant Temperature Gauge
- C—Key Switch
- D—Tachometer
- E—Reset (Safety) Switch
- F—Fuse Holder (14 Amp Fuse)
- G—Ammeter
- H—Hourmeter
- I—Hand Throttle
- J—Tachometer Binary Code

RG11298B -UN-17AUG00

RG10607 -UN-19OCT99

Continued on next page

DPSG, RG34710, 108 -19-08JAN02-1/2

The reset button has to be held in when starting the engine. The button allows the safety switch to override the shut-down circuits until safe engine oil pressure is maintained. Once engine oil pressure is within specifications, the safety switch will latch and the reset button can be released.

**F—Fuse Holder** - Contains 14 amp fuse.

**G—Ammeter** - The ammeter indicates the rate of charge (+) or discharge (—) of the battery. When the engine is first started, the ammeter will usually indicate a charge rate of approximately 30 amps. After a short period of operation, the ammeter needle will point slightly to the right of “0”, indicating the charging system is operating normally. A problem with the charging system is indicated if the ammeter needle points to the left of “0” during engine operation.

**H—Hour Meter** - The hour meter operates when the engine is operating, or when the reset button is manually held in while the key switch is in the ON position. The accumulated hours are displayed in hours and tenths of hours. On some panels, the hourmeter may be separate from the tachometer.

**I—Hand Throttle** - The hand throttle is used to manually control engine speed. If the hand throttle is electronic (as shown), turn the knob clockwise or counterclockwise to change engine speed. If the hand throttle is mechanical (not shown), turning the handle, either clockwise or counterclockwise, will lock the throttle position. Turn the handle half way between the two lock positions to unlock the throttle.

**J—Tachometer Binary Code** - The tachometer is calibrated to the number of flywheel gear teeth read. The dip switch to set the binary code is located in back of tachometer and must be set at “10110011” to operate at 30 pulses per revolution.

## VDO Instrument (Gauge) Panel (Except North America)

All controls and gauges are optional equipment for John Deere OEM Engines. They may be provided by the equipment manufacturer instead of John Deere. The following information applies only to those controls and gauges provided by John Deere.

**IMPORTANT:** Any time an electric gauge or meter does not register correctly, replace it with a new one. Do not attempt to repair it.

Following is a brief description of the components on the instrument (gauge) panel:

**A—Oil Pressure Gauge** - The oil pressure gauge indicates engine oil pressure.

**B—Coolant Temperature Gauge** - The coolant temperature gauge indicates coolant temperature.

**C—Tachometer** - The tachometer indicates engine speed in hundreds of revolutions per minute (rpm).

The engine control system consists of the following:

**D—Engine Control Light** - The engine control light illuminates after the engine has started and oil pressure is up to specification. The light indicates that the engine protection circuitry is activated.

**E—Preheater Light** - The preheater light illuminates when the key is turned to the bulb test position (position I). It should go off after approximately five seconds. When the key switch is held in position II, the engine preheater is energized and the preheater light illuminates.

**F—Fuel Level Light** - The fuel level light illuminates when the key is turned to the bulb test position (position I). It should go off after approximately five seconds. After the engine is running, if the engine runs out of fuel, the light will illuminate and protection circuitry will stop the engine. The fuel level light will remain on indicating the engine was stopped due to the fuel tank being empty.

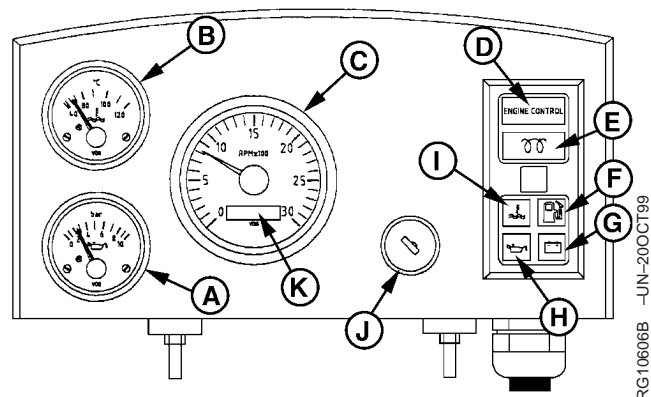

VDO Instrument Panel

- A—Oil Pressure Gauge
- B—Coolant Temperature Gauge
- C—Tachometer
- D—Engine Control Light
- E—Preheater Light
- F—Fuel Level Light
- G—Battery Light
- H—Oil Pressure Light
- I—Coolant Temperature Light
- J—Key/Start Switch
- K—Hour Meter

RG10606B -JUN-20OCT199



**G—Battery Light** - The battery light illuminates when the key is turned to the bulb test position (position I). It should go off after approximately five seconds. After the engine is running, if the alternator stops charging, the light will illuminate and protection circuitry will stop the engine. The battery light will remain on indicating the engine was stopped due to the alternator not charging.

**H—Oil Pressure Light** - The oil pressure light illuminates when the key switch is turned to the bulb test position (position I). The light will remain on until the engine is started and the specified oil pressure is reached. If oil pressure is lost during engine operation, the light will illuminate and protection circuitry will stop the engine. The oil pressure light will remain on, indicating that the engine was stopped due to a low oil pressure condition.

**I—Coolant Temperature Light** - The coolant temperature light illuminates when the key is turned to the bulb test position (position I). It should go off after approximately five seconds. After the engine is running, if the engine overheats, the light will illuminate and protection circuitry will stop the engine. The coolant temperature light will remain on indicating the engine was stopped due to the engine overheating.

Other components on the instrument panel:

**J—Key/Start Switch** - The four-position key start switch controls the electrical system.

**K—Hour Meter** - The hour meter is an integral part of the tachometer. It shows the accumulated hours of engine service. The hour meter operates when the engine is running and accumulated hours are displayed in hours and tenths of hours.

## Engine Break-In Service

The engine is ready for normal operation. However, extra care during the first 250 hours of operation will result in more satisfactory long-term engine performance and life. DO NOT exceed 250 hours of operation with break-in oil.

1. This engine is factory-filled with John Deere ENGINE BREAK-IN OIL. Operate the engine at heavy loads with minimal idling during the break-in period.
2. If the engine has significant operating time at idle, constant speeds, and/or light load usage, or makeup oil is required in the first 250 hour period, a longer break-in period may be required. In these situations, an additional 250 hour break-in period is recommended using a new change of John Deere ENGINE BREAK-IN OIL and a new John Deere oil filter.

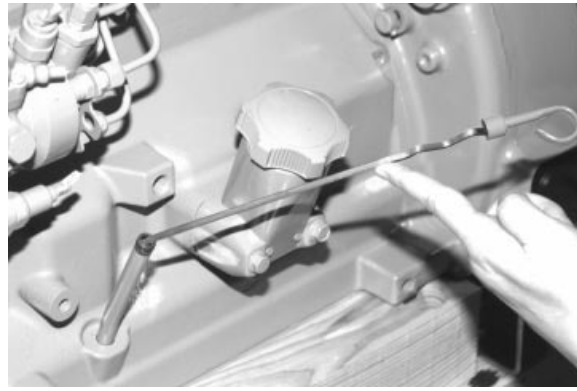

RG8009 -UN-06/JAN99

Check Engine Oil

Continued on next page

OURGP12,0000076 -19-09SEP04-1/4

RG8028A -UN-15JAN99

**IMPORTANT: DO NOT** add makeup oil until the oil level is **BELOW** the **ADD** mark on dipstick. John Deere **ENGINE BREAK-IN OIL (TY22041)** should be used to make up any oil consumed during the break-in period.

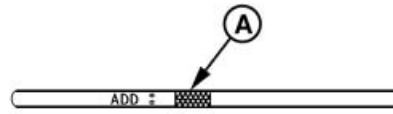

Crosshatch Pattern On Oil Dipstick

**A**—Crosshatch Pattern On Oil Dipstick

3. Check engine oil level more frequently during engine break-in period. If oil must be added during this period, John Deere **ENGINE BREAK-IN OIL** is preferred. See **ENGINE BREAK-IN OIL**, in Fuels, Lubricants, and Coolant Section.

**IMPORTANT: DO NOT** use **PLUS-50® Engine Oil** during the break-in period of a new engine or engine that has had a major overhaul. **PLUS-50®** oil will not allow a new or overhauled engine to properly wear during this break-in period.

**DO NOT** fill above the crosshatch pattern (**A**) or the **FULL** mark, whichever is present. Oil levels anywhere within the crosshatch are considered in the acceptable operating range.

**Specification**

Engine <sup>1</sup> —Oil Pressure at Full Load Rated Speed .....	345 ± 103 kPa (3.45 ± 1.03 bar)
	(50 ± 15 psi)
Minimum Oil Pressure at Rated Speed .....	275 (2.75 bar) (40 psi)
Minimum Oil Pressure at 850 rpm .....	105 kPa (1.05 bar) (15 psi)
Coolant Temperature Range.....	82°–94°C (180°–202°F)

*PLUS-50 is a trademark of Deere & Company.*

<sup>1</sup>At normal operating temperature of 115°C (240°F) sump.

Continued on next page

OURGP12,0000076 -19-09SEP04-2/4

4. During the first 20 hours, avoid prolonged periods of engine idling or sustained maximum load operation. If engine will idle longer than 5 minutes, stop engine.
5. Before the first 250 hours (maximum), change engine oil and replace engine oil filter. (See CHANGING ENGINE OIL AND REPLACING OIL FILTER in Lubrication and Maintenance/250 Hour/6 Month Section.) Fill crankcase with the normal seasonal viscosity grade oil. (See DIESEL ENGINE OIL, in Fuels, Lubricants, and Coolant Section.)



RG7961B -UN-22JAN99

Changing Oil And Oil Filter Before First 250 Hours

**NOTE:** Some increase in oil consumption may be expected when low viscosity oils are used. Check oil levels more frequently.

If air temperature is below  $-10^{\circ}\text{C}$  ( $14^{\circ}\text{F}$ ), use an engine block heater.

OURGP12,0000076 -19-09SEP04-3/4

6. Watch coolant temperature gauge (A) closely. If coolant temperature rises above  $112^{\circ}\text{C}$  ( $234^{\circ}\text{F}$ ), reduce load on engine. Unless temperature drops quickly, stop the engine and determine the cause before resuming operation.

**NOTE:** When the coolant temperature gauge reads approximately  $115^{\circ}\text{C}$  ( $239^{\circ}\text{F}$ ), the engine will shutdown automatically, if equipped with safety controls.

7. Check poly-vee belt for proper alignment and seating in pulley grooves.

**A—Coolant Temperature Gauge**



RG11299F -UN-17AUG00

North American (1999— ) Instrument Panel Shown

OURGP12,0000076 -19-09SEP04-4/4

## Auxiliary Gear Drive Limitations

**IMPORTANT:** When attaching an air compressor, hydraulic pump, or other accessory to be driven by the auxiliary gear drive (A) (engine timing gear train at front of engine), power requirements of the accessory must be limited to values listed below:

- 30 kW (40 hp) Continuous Operation at 2500 rpm
- 37 kW (50 hp) Intermittent Operation at 2500 rpm

A—Auxiliary Gear Drive

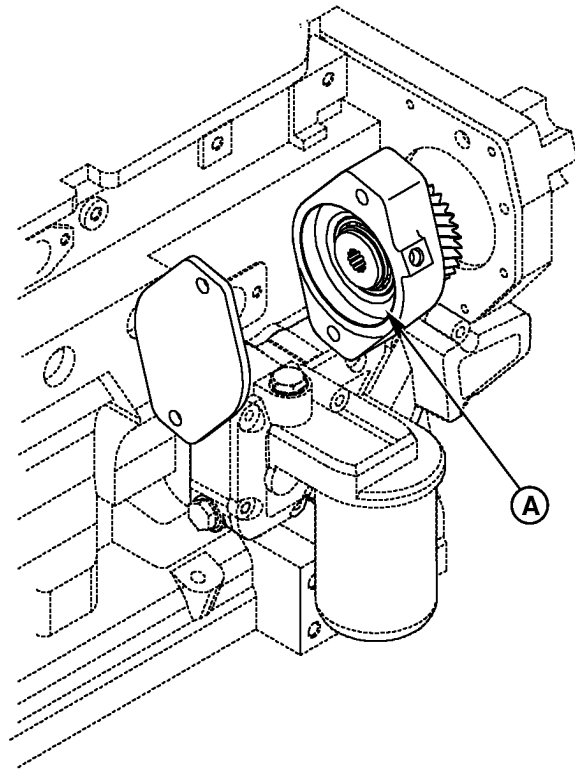

Auxiliary Gear Drive

RG7634A -JUN-22JAN99

RG, RG34710, 5555 -19-27JUL06-1/1

## Generator Set (Standby) Applications

To assure that your engine will deliver efficient standby operation when needed, start engine and run at rated speed (with 50%—70% load) for 30 minutes every 2 weeks. DO NOT allow engine to run extended period of time with no load.

RG, RG34710, 5556 -19-27JUL06-1/1

## Starting the Engine

The following instructions apply to the optional controls and instruments available through the John Deere Parts Distribution Network. The controls and instruments for your engine may be different from those shown here; always follow manufacturer's instructions.

 **CAUTION:** Before starting engine in a confined building, install proper outlet exhaust ventilation equipment. Always use safety approved fuel storage and piping.

*NOTE: If temperature is below 0°C (32°F), it may be necessary to use cold weather starting aids (See COLD WEATHER OPERATION, later in this section).*

1. Perform all prestarting checks outlined in Lubrication & Maintenance/Daily Section later in this manual.
2. Open the fuel supply shut-off valve, if equipped.
3. Disengage clutch (if equipped) controlling any engine drivelines.

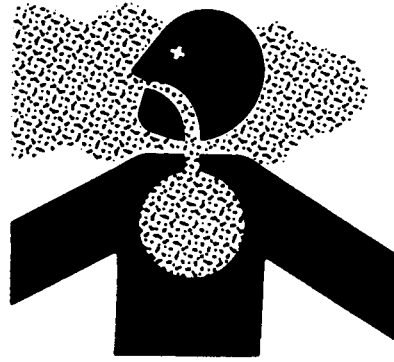

Use Proper Ventilation

TSS220 -JUN-23AUG88

Continued on next page

RG, RG34710, 5557 -19-07JAN02-1/2

**NOTE:** Electronically controlled governor applications may be equipped with a rotary speed potentiometer on the throttle (A) on the instrument panel.

4. On mechanical governor (7-10% regulation) engines, pull hand throttle (A) 1/3 of the way out. Turn the handle in either direction to lock it in place.

5. If equipped, depress and hold reset button (B) while starting.

**IMPORTANT:** Do not operate the starter for more than 30 seconds at a time. To do so may overheat the starter. If the engine does not start the first time, wait at least 2 minutes before trying again. If engine does not start after four attempts, see Troubleshooting Section.

6. Turn the key switch (C) clockwise to crank the engine. When the engine starts, release the key so that it returns to the "ON" position.

**IMPORTANT:** If the key switch is released before the engine starts, wait until the starter and the engine stop turning before trying again. This will prevent possible damage to the starter and/or flywheel.

7. After the engine starts, continue to hold the reset button in until the oil pressure gauge (D) reads at least 105 kPa (1.05 bar) (15 psi). The safety controls will not allow the engine to run at a lower oil pressure unless the reset button is held in.

**IMPORTANT:** Should the engine die when operating under load, immediately disengage PTO clutch and restart the engine. Overheating of turbocharger parts may occur when oil flow is stopped.

8. Check all gauges for normal engine operation. If operation is not normal, stop the engine and determine the cause.

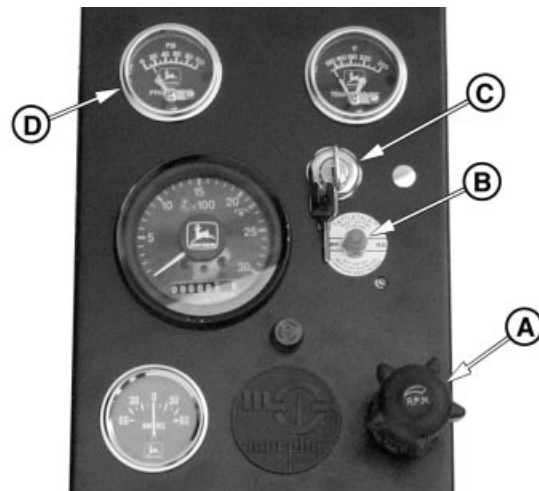

North American Standard Instrument Panel (1999—) Shown

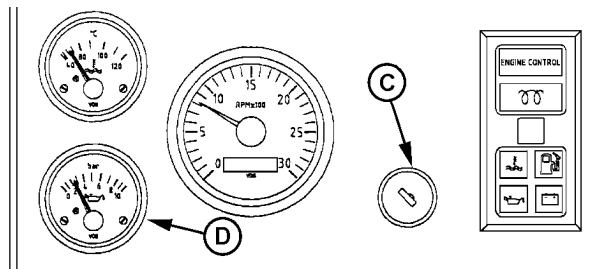

VDO Standard Instrument Panel (Except North America)

- A—Hand Throttle
- B—Reset Button
- C—Key Start Switch
- D—Oil Pressure Gauge

RG11299X -UN-18OCT01

RG11610 -UN-17OCT01

## Warming Engine

**IMPORTANT:** To assure proper lubrication, operate engine at or below 1200 rpm with no load for 1–2 minutes. Extend this period 2–4 minutes when operating at temperatures below freezing.

Engines used in generator set applications where the governor is locked at a specified speed may not have a slow idle function. Operate these engines at high idle for 1 to 2 minutes before applying the load. This procedure does not apply to standby generator sets where the engine is loaded immediately upon reaching rated speed.

1. Check oil pressure gauge (A) as soon as engine starts. If gauge needle does not rise above minimum oil pressure specification of 105 kPa (1.05 bar) (15.0 psi) within 5 seconds, stop the engine and determine the cause. Normal engine oil pressure is 345 kPa (3.45 bar) (50 psi) at rated full load speed (1800–2500 rpm) with oil at normal operating temperature of 115°C (240°F).

**NOTE:** On certain engines, the oil pressure and coolant temperature gauges are replaced by indicator warning lights. The lights must be "OFF" when engine is running.

2. Watch coolant temperature gauge (B). Do not place engine under full load until it is properly warmed up. The normal engine coolant temperature range is 82°–94°C (180°–202°F).

**NOTE:** It is a good practice to operate the engine under a lighter load and at lower speeds than normal for the first few minutes after start-up.



Standard North American Instrument Panel

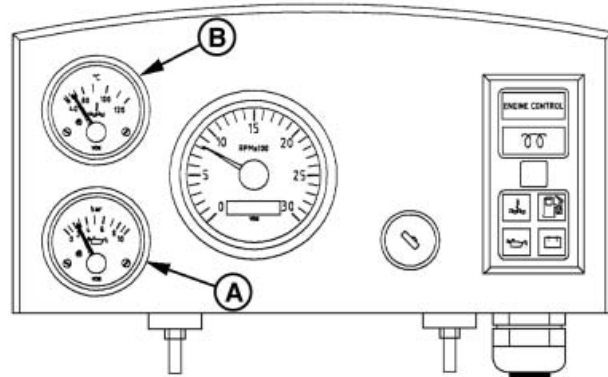

Standard VDO Instrument Panel (Except North America)

A—Oil Pressure Gauge  
B—Coolant Temperature Gauge

RG11612 –UN–17OCT01

RG10613 –UN–21OCT99

RG, RG34710, 5560 –19–08JAN02–1/1



## Normal Engine Operation

Observe engine coolant temperature and engine oil pressure. Temperatures and pressures will vary between engines and with changing operating conditions, temperatures, and loads.

Normal engine coolant operating temperature range is 82°—94°C (180°—202°F). If coolant temperature rises above 112°C (234°F), reduce load on engine. Unless temperature drops quickly, stop engine and determine cause before resuming operation.

Operate the engine under a lighter load and at slower than normal speed for first 15 minutes after start-up. DO NOT run engine at slow idle.

**IMPORTANT: Should the engine die while operating under load, immediately**

**remove load and restart the engine. Overheating of the turbocharger parts may occur when oil flow is stopped.**

Stop engine immediately if there are any signs of part failure. Symptoms that may be early signs of engine problems are:

- Sudden drop in oil pressure
- Abnormal coolant temperatures
- Unusual noise or vibration
- Sudden loss of power
- Excessive black exhaust
- Excessive fuel consumption
- Excessive oil consumption
- Fluid leaks

RG, RG34710, 5552 -19-20MAY96-1/1

## Cold Weather Operation

**CAUTION:** Ether injector starting fluid is highly flammable. **DO NOT** use starting fluid on engines equipped with air intake heaters.

**DO NOT** use starting fluid near fire, sparks, or flames. **DO NOT** incinerate or puncture a starting fluid container.

Engines may be equipped with intake air heaters, coolant heaters, or ether injectors as a cold weather starting aid.

Starting aids are required below 32°F (0°C). They will enhance starting performance above these temperatures and may be needed to start applications that have high parasitic loads during cranking and/or start acceleration to idle.

Using correct grade of oil (per engine and machine operator's manual) is critical to achieving adequate cold weather cranking speed.

Other cold weather starting aids are required at temperatures below -22°F (-30°C) or at altitudes above 1500 m (5000 ft).

1. Follow steps 1—4 as listed under , then proceed as follows according to the instrument (gauge) panel on your engine.
2. Switch on the air intake heater for 30 seconds or activate ether injector by following suppliers instructions.
3. Follow remaining steps 5—8 as listed under earlier in this section.

Additional information on cold weather operation is available from your authorized servicing dealer.



Handle Starting Fluid with Care

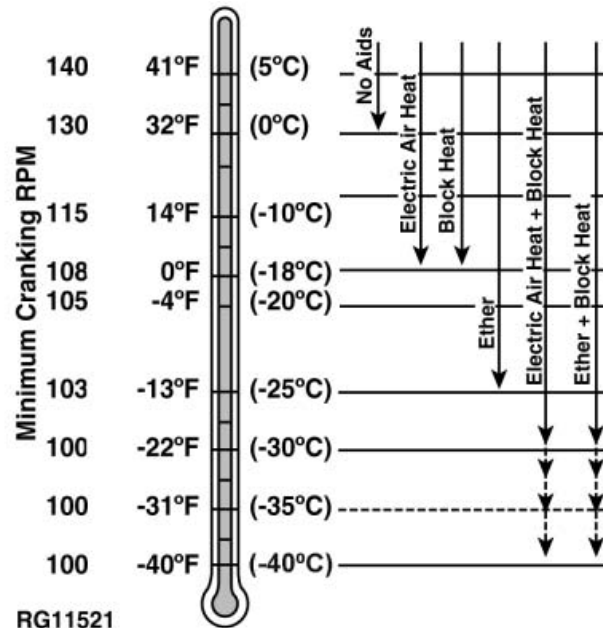

Cold Weather Starting Guidelines

T51356 -UN-18MAR92

RG11521 -19-10JAN01

RG, RG34710, 5050 -19-08JAN02-1/1

## Changing Engine Speed

To increase engine speed, turn throttle handle (A), if equipped, to the horizontal position and pull out until desired engine speed is obtained. Turn the handle in either direction to lock throttle position. The handle is pushed inward to decrease engine speed.

*NOTE: On engines without handle, use throttle lever to control engine speed.*

A—Throttle Handle



North American Standard Instrument Panel Shown

RG112991 -UN-11SEP00

RG, RG34710, 5561 -19-07JAN02-1/1

## Avoid Excessive Engine Idling

Prolonged idling may cause the engine coolant temperature to fall below its normal range. This, in turn, causes crankcase oil dilution, due to incomplete fuel combustion, and permits formation of gummy deposits on valves, pistons, and piston rings. It also promotes rapid accumulation of engine sludge and unburned fuel in the exhaust system.

Once an engine is warmed to normal operating temperatures, engine should be idled at slow idle

speed. Slow idle speed for this engine is 850 rpm at factory. If an engine will be idling for more than 5 minutes, stop and restart later.

*NOTE: Generator set applications where the governor is locked at a specified speed may not have a slow idle function. These engines will idle at no load governed speed (high idle).*

RG, RG34710, 5562 -19-27JUL06-1/1

## Stopping the Engine

1. Disengage clutch (if equipped) controlling engine drivelines.
2. Move the throttle (A) to slow idle on standard (mechanical) governor engines.

**IMPORTANT:** Before stopping an engine that has been operating at working load, idle engine at least 2 minutes at 1000–1200 rpm to cool hot engine parts.

For engines in generator set applications, where the governor is locked at a specified speed and no slow idle function is available, run engine for at least 2 minutes at fast idle and no load.

3. Turn key switch (B) to "OFF" position to stop the engine. Remove ignition key.

**IMPORTANT:** Make sure that exhaust stack cap (rain cap) is installed when engine is not running. This will prevent water and dirt from entering engine.

A—Throttle  
B—Key Switch

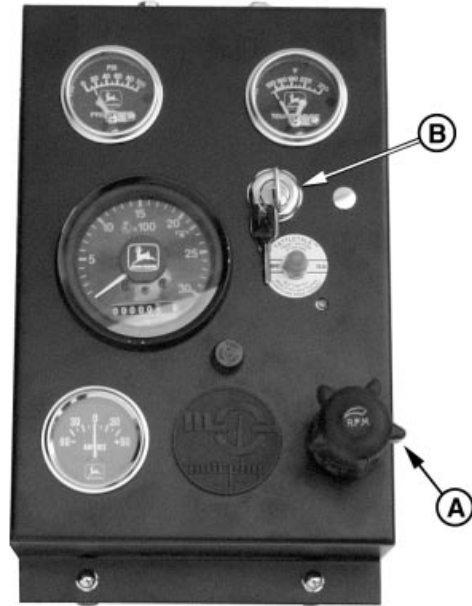

North American Standard Instrument Panel Shown



Exhaust Stack Rain Cap

RG11299J -UN-11SEP00

RG10616 -UN-16JUN00

RG, RG34710, 5563 -19-07JAN02-1/1

## Using a Booster Battery or Charger

A 12-volt booster battery can be connected in parallel with battery (ies) on the unit to aid in cold weather starting. ALWAYS use heavy duty jumper cables.

**CAUTION:** Gas given off by battery is explosive. Keep sparks and flames away from battery. Before connecting or disconnecting a battery charger, turn charger off. Make last connection and first disconnection at a point away from battery. Always connect **NEGATIVE (-)** cable last and disconnect this cable first.

**WARNING:** Battery posts, terminals, and related accessories contain lead and lead compounds, chemicals known to the State of California to cause cancer and reproductive harm. **Wash hands after handling.**

**IMPORTANT:** Be sure polarity is correct before making connections. Reversed polarity will damage electrical system. Always connect positive to positive and negative to ground. Always use 12-volt booster battery for 12-volt electrical systems and 24-volt booster battery (ies) for 24-volt electrical systems.

1. Connect booster battery or batteries to produce the required system voltage for your engine application.

**NOTE:** To avoid sparks, **DO NOT** allow the free ends of jumper cables to touch the engine.

2. Connect one end of jumper cable to the **POSITIVE (+)** post of the booster battery.
3. Connect the other end of the jumper cable to the **POSITIVE (+)** post of battery connected to starter.
4. Connect one end of the other jumper cable to the **NEGATIVE (-)** post of the booster battery.
5. ALWAYS complete the hookup by making the last connection of the **NEGATIVE (-)** cable to a good ground on the engine frame and away from the battery (ies).



Exploding Battery

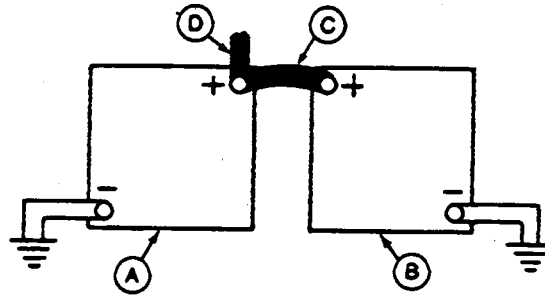

12-Volt System

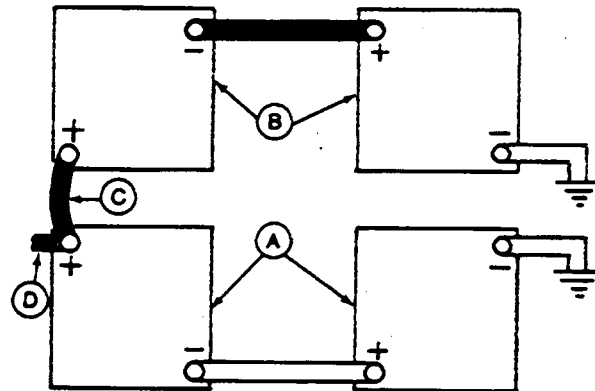

24-Volt System

A—12-Volt Machine Battery (ies)  
 B—12-Volt Booster Battery (ies)  
 C—Booster Cable  
 D—Cable to Starting Motor

T5204 -JUN-23AUG88

RG4678 -JUN-14DEC88

RG4698 -JUN-14DEC88

Continued on next page

RG, RG34710, 5564 -19-27JUL06-1/2

6. Start the engine. Disconnect jumper cables immediately after engine starts. Disconnect NEGATIVE (-) cable first.

RG, RG34710, 5564 -19-27JUL06-2/2

# Lubrication and Maintenance

## Observe Service Intervals

Using hour meter (A) as guide, perform all services at the hourly intervals indicated on following pages. At each scheduled maintenance interval, perform all previous maintenance operations in addition to the ones specified. Keep a record of hourly intervals and services performed using charts provided in Lubrication and Maintenance Records Section.

**IMPORTANT:** Recommended service intervals are for normal operating conditions. Service **MORE OFTEN** if engine is operated under adverse conditions. Neglecting maintenance can result in failures or permanent damage to the engine.

A—Hour Meter

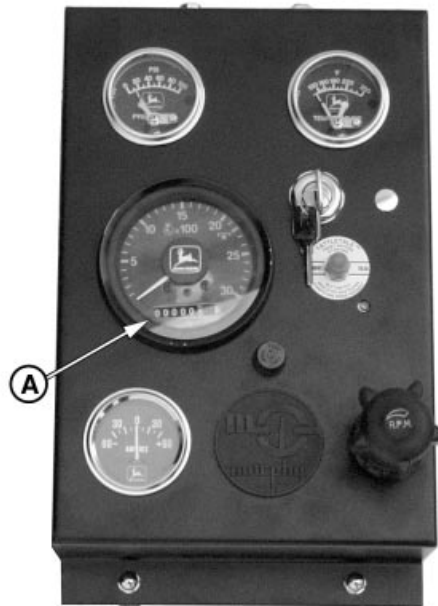

North American Instrument Panel Hour Meter Shown

RG11299A -JUN-17AUG00

DPSG,OUOE003,20 -19-07JAN02-1/1

## Use Correct Fuels, Lubricants, and Coolant

**IMPORTANT:** Use only fuels, lubricants, and coolants meeting specifications outlined in Fuels, Lubricants, and Coolant Section when servicing your John Deere Engine.

Consult your John Deere engine distributor, servicing dealer or your nearest John Deere Parts Network for recommended fuels, lubricants, and coolant. Also available are necessary additives for use when operating engines in tropical, arctic, or any other adverse conditions.



TS100 -JUN-23AUG88

DPSG,OUOE003,20 -19-06JAN99-1/1

## Lubrication and Maintenance Service Interval Chart—Standard Industrial Engines

*NOTE: The service intervals below are for standard industrial engines. See details in Sections which follow these charts.*

Item	Lubrication and Maintenance Service Intervals				
	Daily	250 Hour/ 6 Month	500 Hour/ 12 Month	2000 Hour/ 24 Month	As Required
Check Engine Oil and Coolant Level	•				
Check Fuel Filter(s)/Water Separator Bowl	•				
Check Air Cleaner Dust Unloader Valve & Indicator <sup>a</sup>	•				
Perform Visual Walkaround Inspection	•				
Service Fire Extinguisher		•			
Change Engine Oil And Replace Oil Filter <sup>b</sup>		•			
Check Engine Mounts		•			
Service Battery		•			
Check Manual Belt Tensioner and Belt Wear		•			
Clean Crankcase Vent Tube			•		
Check Air Intake Hoses, Connections, & System			•		
Replace Single or Dual Fuel Filter Elements			•		
Check Automatic Belt Tensioner and Belt Wear			•		
Check Engine Speeds			•		
Check Engine Electrical Ground Connection			•		
Check Cooling System			•		
Coolant Solution Analysis-Add SCAs as required			•		
Pressure Test Cooling System			•		
Check Crankshaft Vibration Damper (6.8 L Engines) <sup>c</sup>				•	
Flush Cooling System <sup>d</sup>				•	
Test Thermostats				•	
Check and Adjust Engine Valve Clearance				•	
Add Coolant					•
Replace Air Cleaner Elements					•
Replace Poly-Vee Belt					•
Check Fuses					•

<sup>a</sup>Replace primary air cleaner element when restriction indicator shows a vacuum of 625 mm (25 in.) H<sub>2</sub>O.

<sup>b</sup>Change the oil for the first time after 100 hours maximum of break-in operation. For subsequent oil and filter intervals, see recommendations in section 10.

<sup>c</sup>Replace crankshaft damper every 4500 hours or 60 months, whichever occurs first.

<sup>d</sup>If John Deere COOL-GARD is used, the flushing interval may be extended to 3000 hours or 36 months. If John Deere COOL-GARD is used and the coolant is tested annually AND additives are replenished as needed by adding a supplemental coolant additive, the flushing interval may be extended to 5000 hours or 60 months, whichever occurs first.

Continued on next page

OURGP11,0000006 -19-13OCT06-1/2



*Lubrication and Maintenance*

Item	Lubrication and Maintenance Service Intervals				
	Daily	250 Hour/ 6 Month	500 Hour/ 12 Month	2000 Hour/ 24 Month	As Required
Check Air Compressor (If Equipped)					•
Bleed Fuel System					•

OURGP11,0000006 -19-13OCT06-2/2

## Lubrication and Maintenance Service Interval Chart—Generator (Standby) Applications

**NOTE:** Use service intervals listed below for generator (standby) applications. Match service items below to titles in Lubrication and Maintenance Sections for procedures.

Item	Lubrication and Maintenance Service Intervals				
	Every 2 Weeks	250 Hours or 12 Months	500 Hours or 12 Months	2000 Hours or 24 Months	As Required
Operate Engine at Rated Speed and 50%–70% Load a Minimum of 30 Minutes	•				
Check Engine Oil and Coolant Level	•				
Check Fuel Filter(s)/Water Separator Bowl	•				
Check Air Cleaner Dust Unloader Valve & Indicator <sup>a</sup>	•				
Perform Visual Walkaround Inspection	•				
Service Fire Extinguisher		•			
Change Engine Oil and Replace Oil Filter <sup>b</sup>		•			
Check Engine Mounts		•			
Service Battery		•			
Clean Crankcase Vent Tube			•		
Check Air Intake Hoses, Connections, & System			•		
Replace Single or Dual Fuel Filter Elements			•		
Check Belt Tensioner and Belt Wear			•		
Check Engine Speeds			•		
Check Engine Electrical Ground Connection			•		
Check Cooling System			•		
Coolant Solution Analysis-Add SCAs as required			•		
Pressure Test Cooling System			•		
Check Variable Speed (Droop) (Gen-Sets)				•	
Check Crankshaft Vibration Damper (6.8 L Engines) <sup>c</sup>				•	
Flush Cooling System <sup>d</sup>				•	
Test Thermostats				•	
Check and Adjust Engine Valve Clearance				•	
Add Coolant					•
Replace Air Cleaner Elements					•

<sup>a</sup>Replace primary air cleaner element when restriction indicator shows a vacuum of 625 mm (25 in.) H<sub>2</sub>O.

<sup>b</sup>Change the oil for the first time after 100 hours maximum of break-in operation. For subsequent oil and filter intervals, see recommendations in section 10.

<sup>c</sup>Replace crankshaft damper every 4500 hours or 60 months, whichever occurs first.

<sup>d</sup>If John Deere COOL-GARD is used, the flushing interval may be extended to 3000 hours or 36 months. If John Deere COOL-GARD is used and the coolant is tested annually AND additives are replenished as needed by adding a supplemental coolant additive, the flushing interval may be extended to 5000 hours or 60 months, whichever occurs first.

Continued on next page

OURGP11,0000007 -19-31OCT06-1/2

*Lubrication and Maintenance*

Item	Lubrication and Maintenance Service Intervals				
	Every 2 Weeks	250 Hours or 12 Months	500 Hours or 12 Months	2000 Hours or 24 Months	As Required
Replace Poly-Vee Belt					•
Check Fuses					•
Check Air Compressor (If Equipped)					•
Bleed Fuel System					•

OURGP11,0000007 -19-31OCT06-2/2

# Lubrication & Maintenance/Daily

## Daily Prestarting Checks

Do the following BEFORE STARTING THE ENGINE for the first time each day:

**IMPORTANT: DO NOT add makeup oil until the oil level is BELOW the add mark.**

1. Check engine oil level on dipstick. Add as required, using seasonal viscosity grade oil. (See DIESEL ENGINE OIL in Fuels, Lubricants, and Coolant Section for oil specifications.)

Depending on application, oil may be added at left (A) or right (B) side oil filler cap and rocker arm cover filler cap (C) locations.

**IMPORTANT: DO NOT fill above the top mark on the dipstick. Oil levels anywhere within crosshatch (D) are considered in the acceptable operating range.**

- A—Left Side Oil Filler Cap
- B—Right Side Oil Filler Cap
- C—Cover Oil Filler Cap
- D—Crosshatch On Dipstick



Left Side Oil Filler Cap

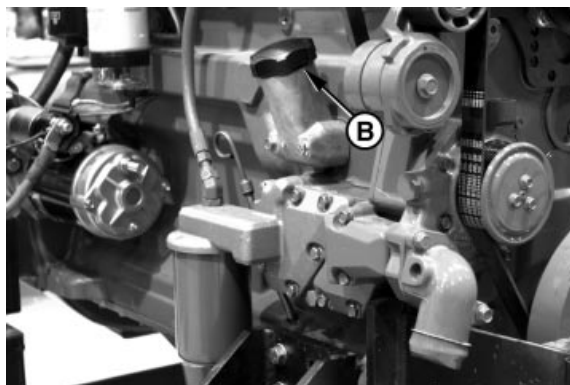

Right Side Oil Filler Cap

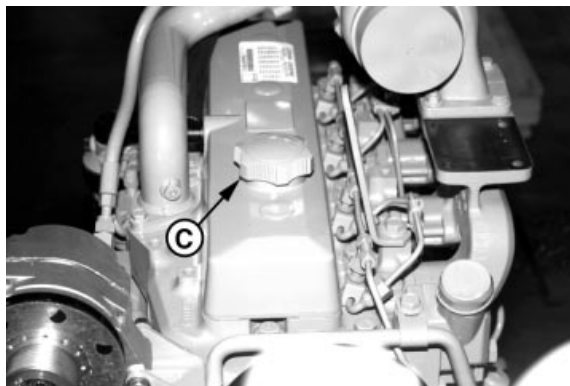

Rocker Arm Cover Filler Cap

RG8028B -UN-15JAN99

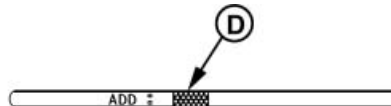

Crosshatch on Dipstick

Continued on next page

OURGP12,000048 -19-13OCT06-1/4

**CAUTION:** Explosive release of fluids from pressurized cooling system can cause serious burns.

Only remove filler cap when engine is cold or when cool enough to touch with bare hands. Slowly loosen cap to first stop to relieve pressure before removing completely.

2. Check the coolant level when engine is cold. Coolant level should be at bottom of filler neck. Fill radiator (A) with proper coolant solution if level is low. (See **ADDING COOLANT** in Service As Required Section.) Check overall cooling system for leaks.

**NOTE:** Refer to your vehicle's operator's manual for recommendations for non-John Deere supplied accessories.

A—Fill Radiator

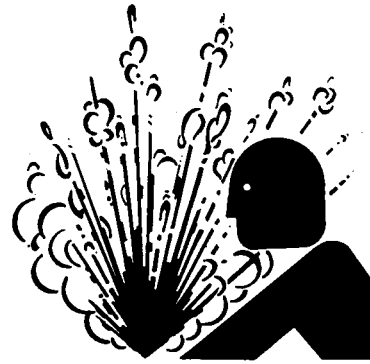

High-Pressure Fluids

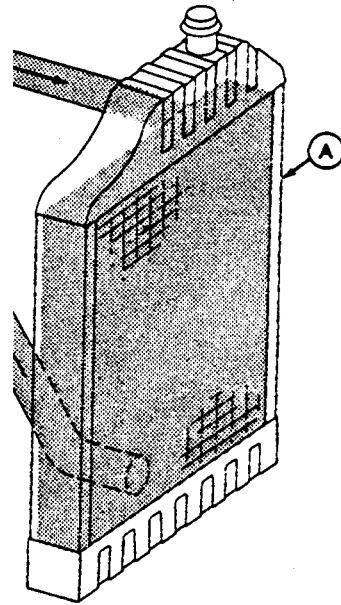

Fill Radiator

RG4675 -UN-14DEC88

TSS281 -UN-23AUG88

Continued on next page

OURGP12,000048 -19-13OCT06-2/4

3. Check the single or dual fuel filters for water or debris. If filter is fitted with a see-through water separator bowl, drain as needed based on a daily visual inspection.

**IMPORTANT: Drain water into a suitable container and dispose of properly.**

- a. Loosen drain plugs (B) at bottom of each fuel filter or bowl, if equipped, two or three turns.
- b. Loosen air bleed plugs (A) two full turns on fuel filter mountings and drain water from bottom until fuel starts to drain out.
- c. When fuel starts to drain out, tighten drain plugs securely.

After draining water from the fuel filter, the filter must be primed by bleeding all air from the fuel system.

- a. Operate primer lever of the fuel supply pump (C) until fuel flow is free from air bubbles.
- b. Tighten bleed plugs securely, and continue operating hand primer until pumping action is not felt. Primer lever is spring-loaded, and will return to normal position.

If the fuel system needs further bleeding of air, see BLEEDING FUEL SYSTEM in Service As Required Section, later in this manual.

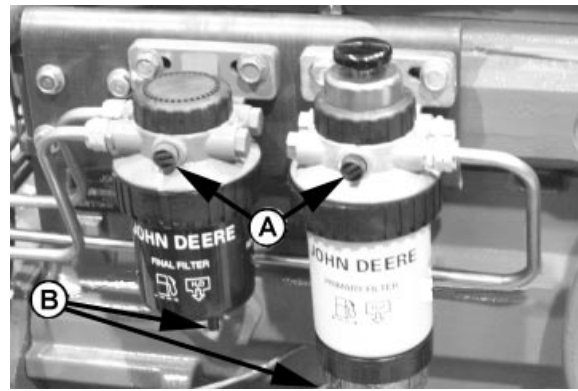

Drain Fuel Filters (Dual Filters Shown)

RG13542 -UN-20JUL04

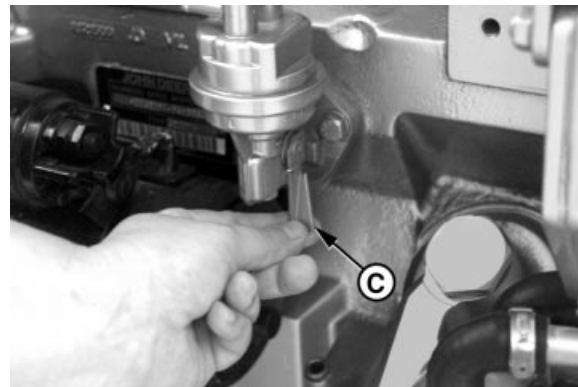

Priming At Fuel Supply Pump

RG7317A -UN-16JUN00

- A—Air Bleed Plugs
- B—Drain Plugs
- C—Fuel Supply Pump Primer Lever

Continued on next page

OURGP12,000048 -19-13OCT06-3/4

4. If the air cleaner has an automatic dust unloader valve (A), squeeze the unloader valve on air cleaner assembly to clear away any dust buildup.

If equipped with air intake restriction indicator gauge (B), check gauge to determine if air cleaner needs to be serviced.

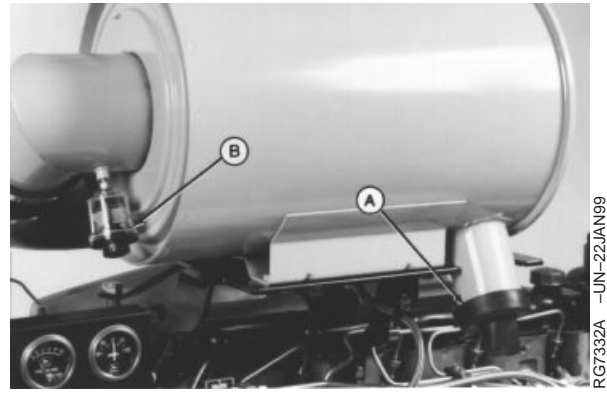

Dust Unloader Valve and Indicator Gauge

A—Dust Unloader Valve  
B—Air Restriction Indicator

**IMPORTANT:** Maximum air intake restriction is 6.25 kPa (0.06 bar) (1.0 psi) (25 in. H<sup>2</sup>O). A clogged air cleaner element will cause excessive intake restriction and a reduced air supply to the engine.

5. Make a thorough inspection of the engine compartment. Look for oil or coolant leaks, worn fan and accessory drive belts, loose connections and trash build-up. Remove trash buildup and have repairs made as needed if leaks are found.

*NOTE: Wipe all fittings, caps, and plugs before performing any maintenance to reduce the chance of system contamination.*

Inspect:

- Radiator for leaks and trash build-up.
- Air intake system hoses and connections for cracks and loose clamps.
- Fan, alternator, and accessory drive belts for cracks, breaks or other damage.
- Water pump for coolant leaks.

*NOTE: It is normal for a small amount of leakage to occur as the engine cools down and parts contract. Excessive coolant leakage may indicate the need to replace the water pump seal. Contact your engine distributor or servicing dealer for repairs.*

OURGP12,000048 -19-13OCT06-4/4

# Lubrication & Maintenance/250 Hour/6 Month

## Servicing Fire Extinguisher

A fire extinguisher (A) is available from your authorized servicing dealer or engine distributor.

Read and follow the instructions which are packaged with it. The extinguisher should be inspected at least every 250 hours of engine operation or once a month. Once extinguisher is operated, no matter how long, it must be recharged. Keep record of inspections on the tag which comes with the extinguisher instruction booklet.

A—Fire Extinguisher



*Fire Extinguisher*

RW4918 -UN-15DEC88

RG, RG34710, 5567 -19-20MAY96-1/1



## Changing Engine Oil and Replacing Filter

**NOTE:** Change engine oil and oil filter for the first time after 100 hours maximum of operation, then every 250 hours thereafter.

If John Deere PLUS-50® or ACEA E4 or E5 engine oil and a John Deere oil filter are used, the oil and filter change interval may be extended by 50 percent.

OILSCAN® or OILSCAN PLUS® is a John Deere sampling program to help you monitor machine performance and identify potential problems before they cause serious damage. OILSCAN® and OILSCAN PLUS® kits are available from your John Deere engine distributor or servicing dealer. Oil samples should be taken prior to the oil change. Refer to instructions provided with kit.

### To change engine oil and oil filter:

1. Run engine approximately 5 minutes to warm up oil. Shut engine off.
2. Remove oil pan drain plug (arrow).
3. Drain crankcase oil from engine while warm.

**NOTE:** Drain plug location may vary, depending on the application.



Oil Filter

RG11616 -JUN-24OCT01



Oil Pan Drain Plug

RG4881 -JUN-29NOV88

A—Oil Filter Element

PLUS-50 is a trademark of Deere & Company.  
OILSCAN is a trademark of Deere & Company.  
OILSCAN PLUS is a trademark of Deere & Company.

Continued on next page

OURGP12,0000078 -19-31OCT06-1/3

- Turn filter element (A) counterclockwise using a suitable filter wrench to remove. Discard oil filter element.

*NOTE: Depending on engine application, oil filter may be located on either side of the engine.*

- Remove oil filter packing and clean filter mounting pad.

**IMPORTANT: Filtration of oils is critical to proper lubrication. Always change filter regularly. Use filter meeting John Deere performance specifications.**

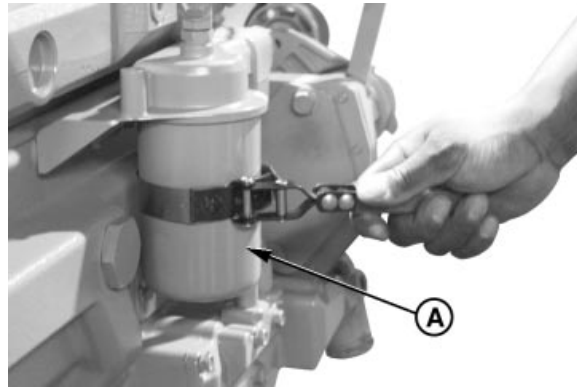

RG7961A -UN-22JAN99

Removing Oil Filter Element

A—Oil Filter Element

- Oil new packing and install new filter element. Hand tighten element according to values printed on filter element. If values are not provided, tighten element approximately 3/4 — 1-1/4 turn after packing contacts filter housing. DO NOT overtighten filter element.
- Install oil pan drain plug with O-ring or copper washer. If copper washer is used, install with raised center against plug. If O-ring or washer is damaged, replace it.
- Tighten drain plug to specifications.

**Specification**

Oil Pan Drain Plug With Copper Washer—Torque .....	70 N•m (52 lb ft)
Oil Pan Drain Plug With O-Ring—Torque .....	50 N•m (37 lb ft)

Continued on next page

OURGP12,0000078 -19-31OCT06-2/3

9. Fill engine crankcase with correct John Deere engine oil through rocker arm cover opening (B) or either side oil filler (C) depending on engine application. (See DIESEL ENGINE OIL in Fuels, Lubricants, and Coolant Section for determining correct engine oil.)

To determine the correct oil fill quantity for your engine, see ENGINE CRANKCASE OIL FILL QUANTITIES in the Specifications Section of this manual.

**IMPORTANT:** Immediately after completing any oil change, crank engine for 30 seconds without permitting engine to start. This will help insure adequate lubrication to engine components before engine starts.

*NOTE:* Crankcase oil capacity may vary slightly. ALWAYS fill crankcase to full mark or within crosshatch on dipstick, whichever is present. DO NOT overfill.

10. Start engine and run to check for possible leaks.
11. Stop engine and check oil level after 10 minutes. Oil level reading should be within crosshatch of dipstick.

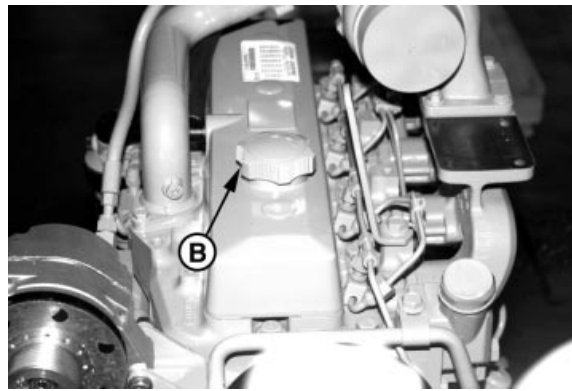

Rocker Arm Cover Oil Filler

RG8025A -UN-19JUN00

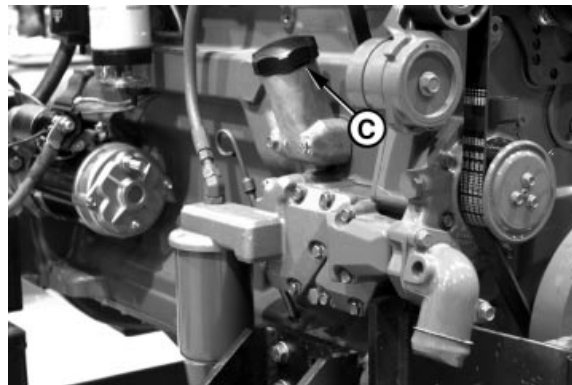

Side Oil Filler

RG8054B -UN-19JUN00

**B**—Rocker Arm Cover Oil Filler  
**C**—Side Oil Filler

OURGP12,000078 -19-31OCT06-3/3

## Checking Engine Mounts

Engine mounting is the responsibility of the vehicle or generator manufacturer. Follow manufacturer's guidelines for mounting specifications.

**IMPORTANT:** Use only Grade SAE 8 or higher grade of hardware for engine mounting.

1. Check the engine mounting bracket, vibration isolators, and mounting bolts on support frame and engine block for tightness. Tighten as necessary.
2. Inspect overall condition of vibration isolators, if equipped. Replace isolators if rubber has deteriorated or mounts have collapsed, as necessary.

DPSG, RG34710, 111 -19-07JAN02-1/1

## Servicing Battery



**CAUTION:** Battery gas can explode. Keep sparks and flames away from batteries. Use a flashlight to check battery electrolyte level.

Never check battery charge by placing a metal object across the posts. Use a voltmeter or hydrometer.

Always remove grounded **NEGATIVE (-)** battery clamp first and replace it last.



Exploding Battery

TSS204 -JUN-23AUG88

**WARNING:** Battery posts, terminals, and related accessories contain lead and lead compounds, chemicals known to the State of California to cause cancer and reproductive harm. **Wash hands after handling.**

1. On regular batteries, check electrolyte level. Fill each cell to bottom of filler neck with distilled water.

*NOTE: Low-maintenance or maintenance-free batteries should require little additional service. However, electrolyte level can be checked by cutting the center section of decal on dash-line, and removing cell plugs. If necessary, add clean, soft water to bring level to bottom of filler neck.*

2. Keep batteries clean by wiping them with a damp cloth. Keep all connections clean and tight. Remove any corrosion, and wash terminals with a solution of 1 part baking soda and 4 parts water. Tighten all connections securely.

*NOTE: Coat battery terminals and connectors with a mixture of petroleum jelly and baking soda to retard corrosion.*

3. Keep battery fully charged, especially during cold weather. If a battery charger is used, turn charger off before connecting charger to battery(ies). Attach **POSITIVE (+)** battery charger lead to **POSITIVE (+)** battery post. Then attach **NEGATIVE (-)** battery charger lead to a good ground.

Continued on next page

RG, RG34710, 5568 -19-27JUL06-1/2

**CAUTION:** Sulfuric acid in battery electrolyte is poisonous. It is strong enough to burn skin, eat holes in clothing, and cause blindness if splashed into eyes.

Avoid the hazard by:

1. Filling batteries in a well-ventilated area.
2. Wearing eye protection and rubber gloves.
3. Avoiding breathing fumes when electrolyte is added.
4. Avoiding spilling or dripping electrolyte.
5. Use proper jump start procedure.

If you spill acid on yourself:

1. Flush your skin with water.
2. Apply baking soda or lime to help neutralize the acid.
3. Flush your eyes with water for 10–15 minutes. Get medical attention immediately.

If acid is swallowed:

1. Drink large amounts of water or milk.
2. Then drink milk of magnesia, beaten eggs, or vegetable oil.
3. Get medical attention immediately.

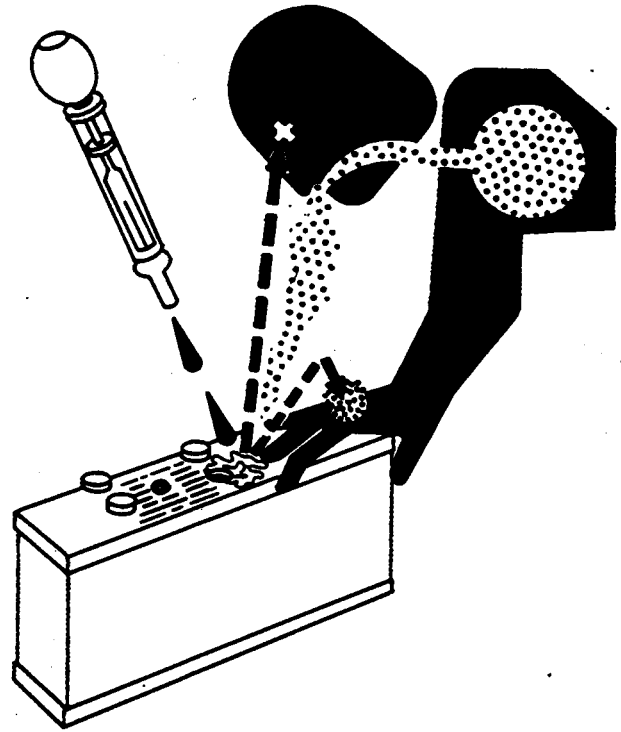

Sulfuric Acid

TS203 -JUN-23AUG88

In freezing weather, run engine at least 30 minutes to assure thorough mixing after adding water to battery.

If necessary to replace battery(ies), replacements must meet or exceed the following recommended capacities at -18°C (0°F):

**Specification**

12 Volt Standard Duty Starter—	
Cold Cranking Amps .....	640
12 Volt Heavy Duty Starter—Cold	
Cranking Amps .....	800
24 Volt Standard Duty Starter—	
Cold Cranking Amps .....	570

RG, RG34710, 5568 -19-27JUL06-2/2

## Manual Belt Tensioner Adjustment

**NOTE:** Two types of manual tensioners shown.

**NOTE:** Inspect belts for cracks, fraying, or stretched-out areas. Replace if necessary.

As a reference check, twist belt in the middle of a 254—305 mm (10—12 in.) span with two fingers. A properly tensioned belt will turn 75—85 degrees. If belt turns more, it needs to be tightened. If belt turns less, it needs to be loosened.

**NOTE:** If timing gear cover or alternator bracket interfere with installation/centering of belt tension gauge (A), install gauge with face toward engine.

1. Install JDG1341 Belt Tension Gauge (A) on belt, halfway between pulleys as shown. (JDG1341 Belt Tension Gauge available from local John Deere Dealer or Distributor.)
2. Loosen cap screws (B) and (C).
3. Slide alternator or tensioner bracket (D) in slot by hand to remove all excess slack in belt.

**IMPORTANT:** Do not pry against alternator rear frame.

4. Stretch belt by prying outward on alternator front frame or tensioner bracket. Observing tension gauge, stretch the belt until specified tension is achieved.

### Specification

New Belt—Tension.....	470—650 N (105—145 lb-force)
Used Belt—Tension.....	400—580 N (90—130 lb-force)

5. Tighten cap screws (B) and (C).

**NOTE:** After ten minutes run-in, new belts are considered used. Belt tension must then be rechecked per used belt specifications.

6. Run engine for ten minutes and immediately re-check belt tension per used belt specification above.
7. Reset belt tension as necessary.

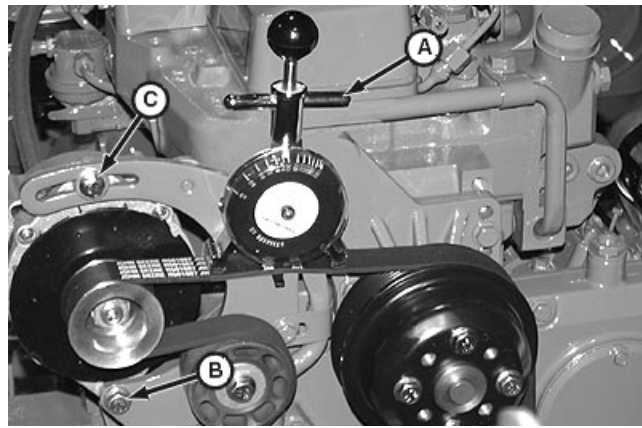

Check Belt Tension

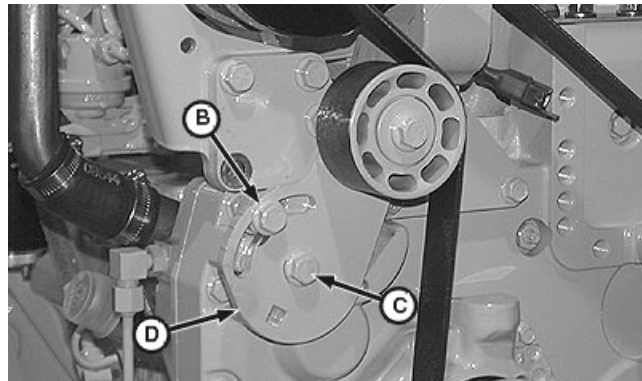

Adjust Belt Tension

- A—Belt Tension Gauge
- B—Cap Screw
- C—Cap Screw
- D—Tensioner Bracket

## Manual Belt Tensioner Adjustment Using Belt Tension Tool (Alternate Method For Engines Without Auxiliary Drive)

**NOTE:** The JDG1520 Belt Tension Tool may not be compatible with all alternators. In that case, use the preceding method for belt tensioning.

**NOTE:** Inspect belts for cracks, fraying, or stretched-out areas. Replace if necessary.

As a reference check, twist belt in the middle of a 254—305 mm (10—12 in.) span with two fingers. A properly tensioned belt will turn 75—85 degrees. If belt turns more, it needs to be tightened. If belt turns less, it needs to be loosened.

1. Loosen upper (A) and lower (B) alternator bracket cap screws. Lower cap screw must remain tight enough to prevent excessive alternator play but allow alternator to pivot by hand.
2. Insert JDG1520 Belt Tension Tool (C) behind belt (D) and over alternator mounting screw.

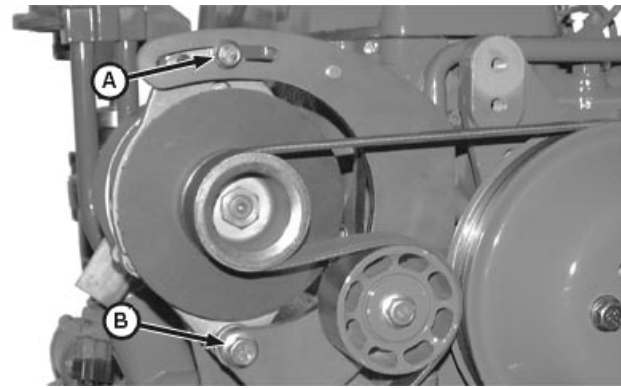

Alternator Bracket and Cap Screws

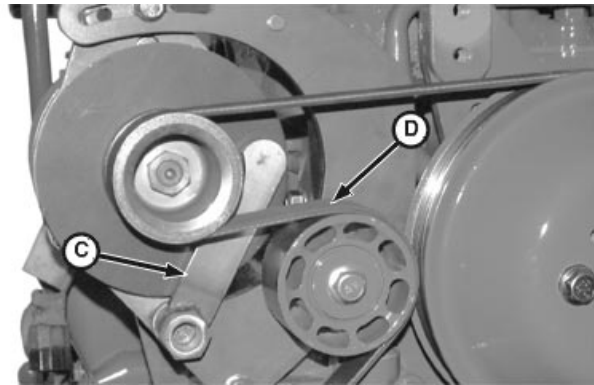

Belt Tension Tool

- A—Upper Alternator Bracket Cap Screw
- B—Lower Alternator Bracket Cap Screw
- C—JDG1520 Belt Tension Tool
- D—Belt

Continued on next page

OURGP11,0000009 -19-24JUN04-1/2

- Place torque wrench (C) on belt tensioning tool (B) at 90° to tool. Pivot alternator (A) until desired torque is achieved according to specification using the following table.

**Specification**

New Belt—Tension..... 470—650 N (105—145 lb-force)  
 Used Belt—Tension..... 400—580 N (90—130 lb-force)

JDG1520 Belt Tensioning Tool Torque Table	
Desired Belt Tension N (lb-force)	Applied Torque On Tool N•m (lb-ft)
445 (100)	108 (90)
489 (110)	115 (85)
534 (120)	122 (90)
623 (140)	135 (100)

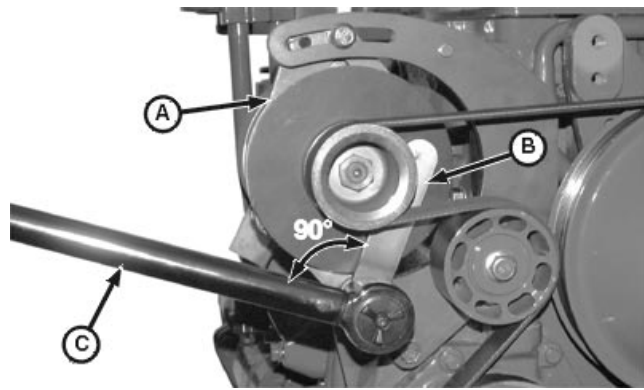

Belt Tension Tool and Torque Wrench

RG11814 -UN-31OCT01

- While holding tension with torque wrench (B), scribe a reference mark (D) on alternator in line with notch (E) on upper alternator bracket.
- Continue to hold tension with torque wrench and tighten upper alternator bracket cap screw.
- Check position of reference mark to see if alternator moved while tightening. If alternator moved, loosen upper alternator bracket cap screw and repeat the tension adjustment procedure.
- Remove belt tension tool and tighten lower alternator bracket cap screw.

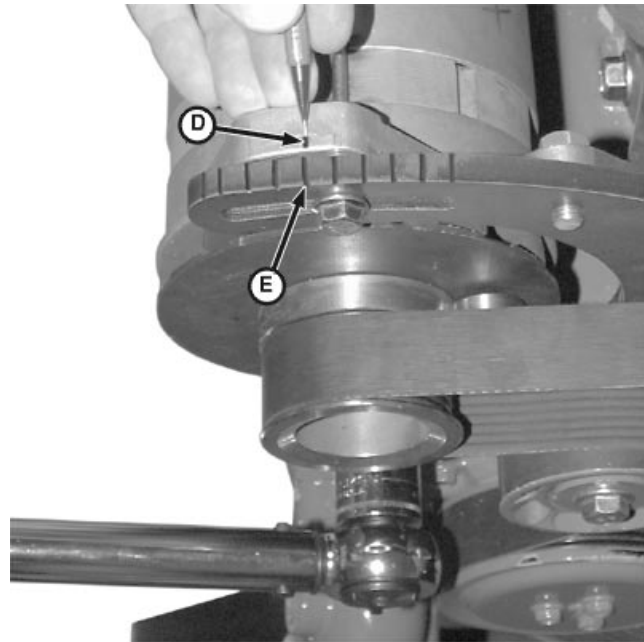

Scribe Reference Mark

RG11815 -UN-31OCT01

- A—Alternator
- B—Belt Tensioning Tool
- C—Torque Wrench
- D—Reference Mark
- E—Alternator Upper Bracket Notch

OURGP11.0000009 -19-24JUN04-2/2



# Lubrication & Maintenance/500 Hour/12 Month

## Cleaning Crankcase Vent Tube

If you operate the engine in dusty conditions, clean the tube at shorter intervals.

1. Remove and clean crankcase vent tube (A).
2. Install the vent tube. Be sure the O-ring fits correctly in the rocker arm cover for elbow adapter. Tighten hose clamp securely.

**A—Crankcase Vent Tube**

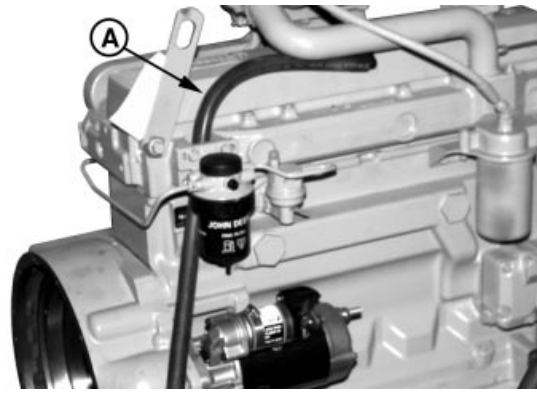

*Crankcase Vent Tube*

RG, RG34710, 5574 -19-08JAN02-1/1

## Checking Air Intake System

**IMPORTANT:** The air intake system must not leak. Any leak, no matter how small, may result in internal engine damage due to abrasive dirt and dust entering the intake system.

1. Inspect all intake hoses (piping) for cracks. Replace as necessary.
2. Check clamps (A) on piping which connect the air cleaner, engine and, if present, turbocharger. Tighten clamps as necessary. This will help prevent dirt from entering the air intake system through loose connections causing internal engine damage.
3. If engine has a rubber dust unloader valve (B), inspect the valve on bottom of air cleaner for cracks or plugging. Replace as necessary.

**IMPORTANT:** ALWAYS REPLACE primary air cleaner element when air restriction indicator shows a vacuum of 625 mm (25 in.) H<sub>2</sub>O, is torn, or visibly dirty.

4. Test air restriction indicator (C) for proper operation. Replace indicator as necessary.

**IMPORTANT:** If not equipped with air restriction indicator, replace air cleaner elements at 500 Hours or 12 Months, whichever occurs first.

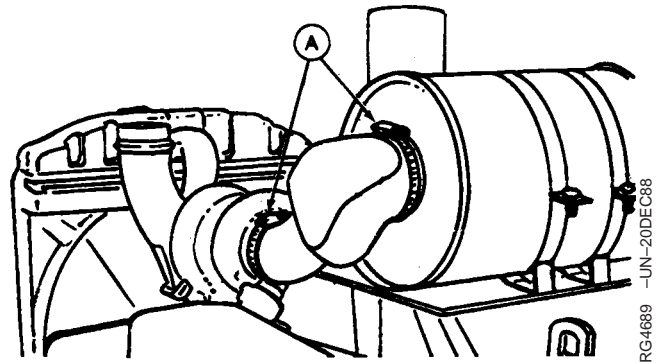

Check Clamps

RG4689 -UN-20DEC88

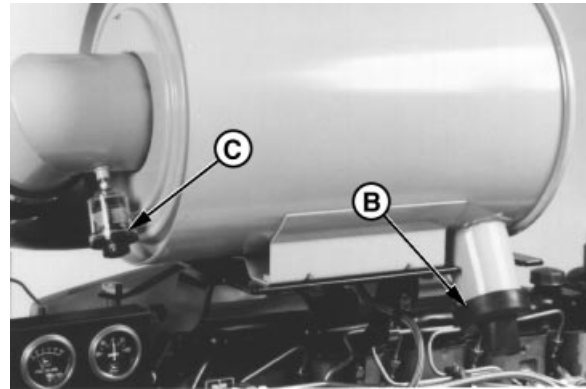

Unloader Valve and Air Restriction Indicator

RG7332B -UN-22JAN99

- A—Clamps
- B—Dust Unloader Valve
- C—Air Restriction Indicator

RG, RG34710, 5575 -19-07JAN02-1/1

## Replacing Fuel Filter Element (Single Filter)

**CAUTION:** Escaping fluid under pressure can penetrate the skin causing serious injury. Relieve pressure before disconnecting fuel or other lines. Tighten all connections before applying pressure. Keep hands and body away from pinholes and nozzles which eject fluids under high pressure. Use a piece of cardboard or paper to search for leaks. Do not use your hand.

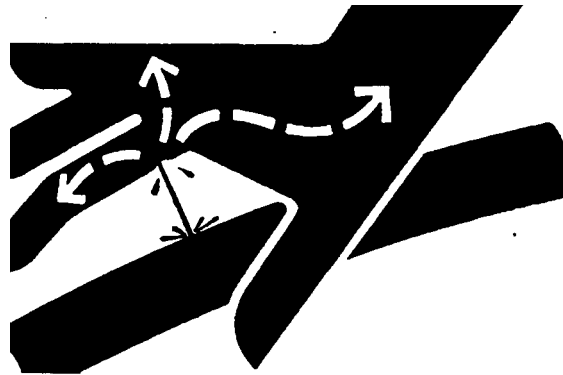

High-Pressure Fluids

X9811 -UN-23AUG88

If any fluid is injected into the skin, it must be surgically removed within a few hours by a doctor familiar with this type injury or gangrene may result. Doctors unfamiliar with this type of injury may call the Deere & Company Medical Department in Moline, Illinois, or other knowledgeable medical source.

1. Close fuel shut-off valve, if equipped.
2. Thoroughly clean fuel filter assembly and surrounding area.
3. Loosen drain plug (C) and drain fuel into a suitable container.

**NOTE:** Lifting up on retaining ring as it is rotated helps to get it past raised locators.

4. Firmly grasp the retaining ring (A) and rotate it clockwise 1/4 turn (when viewed from top). Remove ring with filter element (B).
5. Inspect filter mounting base for cleanliness. Clean as required.

**NOTE:** Raised locators on fuel filter canister must be indexed properly with slots in mounting base for correct installation.

6. Install new filter element onto mounting base. Be sure element is properly indexed and firmly seated on base. It may be necessary to rotate filter for correct alignment.

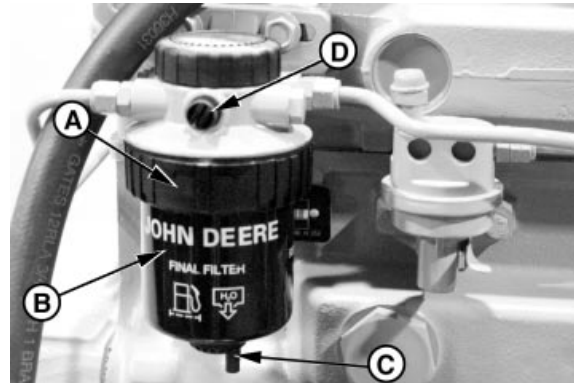

Fuel Filter

- A—Retaining Ring
- B—Filter Element
- C—Drain Plug
- D—Bleed Plug

RG7721 -UN-15JAN99

7. Align keys on filter element with slots in filter base.
8. Install retaining ring onto mounting base making certain dust seal is in place on filter base. Hand tighten ring (about 1/3 turn) until it "snaps" into the detent. DO NOT overtighten retaining ring.

*NOTE: The proper installation is indicated when a "click" is heard and a release of the retaining ring is felt.*

*A plug is provided with the new element for plugging the used element.*

9. Open fuel shut-off valve and bleed the fuel system. (See BLEEDING FUEL SYSTEM in Service As Required Section.) Tighten bleed plug (D).

OURGP11,000000A -19-24JUN04-2/2

## Replacing Fuel Filter Elements (Dual Filters)

**CAUTION:** Escaping fluid under pressure can penetrate the skin causing serious injury. Relieve pressure before disconnecting fuel or other lines. Tighten all connections before applying pressure. Keep hands and body away from pinholes and nozzles which eject fluids under high pressure. Use a piece of cardboard or paper to search for leaks. Do not use your hand.

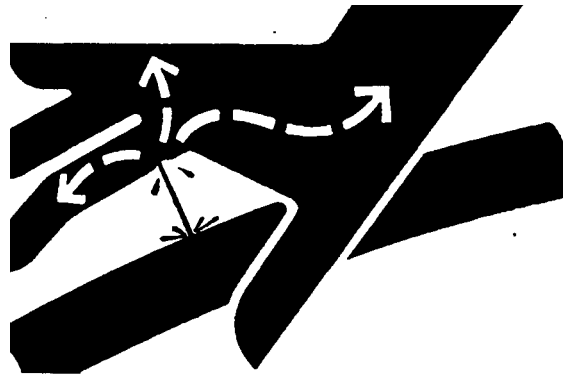

High-Pressure Fluids

X9811 -UN-23AUG88

If any fluid is injected into the skin, it must be surgically removed within a few hours by a doctor familiar with this type injury or gangrene may result. Doctors unfamiliar with this type of injury may call the Deere & Company Medical Department in Moline, Illinois, or other knowledgeable medical source.

1. Close fuel shut-off valve, if equipped.
2. Thoroughly clean fuel filter assemblies and surrounding area.

*NOTE: Perform the following steps on each fuel filter.*

3. Loosen drain plug (C) and drain fuel into a suitable container.

*NOTE: Lifting up on retaining ring as it is rotated helps to get it past raised locators.*

4. Firmly grasp the retaining ring (A) and rotate it clockwise 1/4 turn (when viewed from top). Remove ring with filter element (B).
5. Inspect filter mounting base for cleanliness. Clean as required.
6. On primary filter with water separator, remove filter element from water separator bowl. Drain and clean separator bowl. Dry with compressed air. Install water separator bowl onto new element. Tighten securely.

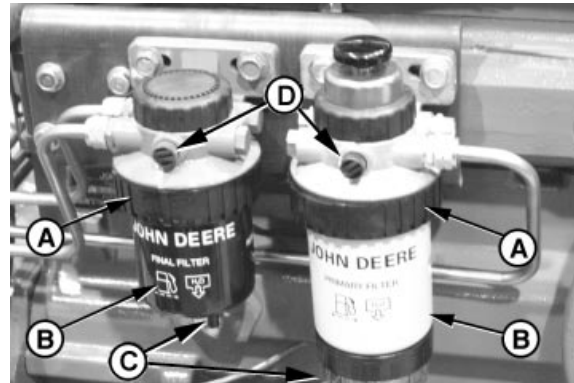

Dual Fuel Filters (Final Filter at Left, Primary Filter with Bowl at Right)

- A—Retaining Ring
- B—Filter Element
- C—Drain Plug
- D—Bleed Plug

RG13543 -UN-21JUL04

Continued on next page

OURGP12.000004B -19-13OCT06-1/2

*NOTE: Raised locators on fuel filter canister must be indexed properly with slots in mounting base for correct installation.*

7. Install new filter element onto mounting base. Be sure element is properly indexed and firmly seated on base. It may be necessary to rotate filter for correct alignment.
8. Align keys on filter element with slots in filter base.
9. Install retaining ring onto mounting base making certain dust seal is in place on filter base. Hand tighten ring (about 1/3 turn) until it "snaps" into the detent. DO NOT overtighten retaining ring.

*NOTE: The proper installation is indicated when a "click" is heard and a release of the retaining ring is felt.*

*A plug is provided with the new element for plugging the used element.*

10. Open fuel shut-off valve and bleed the fuel system. (See BLEEDING FUEL SYSTEM in Service As Required Section.) Tighten bleed plug (D).

OURGP12,000004B -19-13OCT06-2/2

### **Checking Belt Tensioner Spring Tension and Belt Wear (Automatic Tensioner)**

Belt drive systems equipped with automatic (spring) belt tensioners cannot be adjusted or repaired. The automatic belt tensioner is designed to maintain proper belt tension over the life of the belt. If tensioner spring tension is not within specification, replace tensioner assembly.

Continued on next page

OURGP12,000004A -19-28JUL04-1/3

### Checking Belt Wear

The belt tensioner is designed to operate within the limit of arm movement provided by the cast stops (A and B) when correct belt length and geometry is used.

Visually inspect cast stops (A and B) on belt tensioner assembly.

If the tensioner stop on swing arm (A) is hitting the fixed stop (B), check mounting brackets (alternator, belt tensioner, idler pulley, etc.) and the belt length. Replace belt as needed (see REPLACING FAN AND ALTERNATOR BELTS in Service As Required Section).

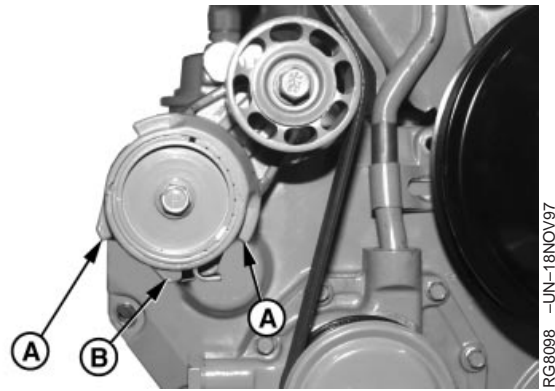

Cast Stops

A—Cast Stops  
B—Cast Stop

Continued on next page

OURGP12,000004A -19-28JUL04-2/3

### Checking Tensioner Spring Tension

A belt tension gauge will not give an accurate measure of the belt tension when automatic spring tensioner is used. Measure tensioner spring tension using a torque wrench and procedure outlined below:

**NOTE:** Later engines have a 12.7 mm (1/2 in.) square drive hole in tensioner, so no socket drive is required.

1. Release tension on belt using a breaker bar and socket (if required) on tension arm. Remove belt from pulleys.
2. Release tension on tension arm and remove breaker bar.
3. Put a mark (A) on swing arm of tensioner as shown.
4. Measure 21 mm (0.83 in.) from (A) and put a mark (B) on tensioner mounting base.
5. Install torque wrench (C) so that it is aligned with center of pulley and tensioner. Rotate the swing arm with the torque wrench until marks (A and B) are aligned.
6. Record torque wrench measurement and compare with specification below. Replace tensioner assembly as required.

**Specification**

Spring Tension—Torque ..... 18-22 N•m (13-16 lb-ft)

**NOTE:** Threads on earlier belt tensioner roller cap screw are LEFT-HAND threads.

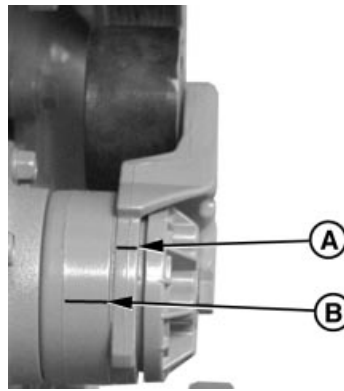

Marks on Tensioner

RG7977 -UN-14NOV97

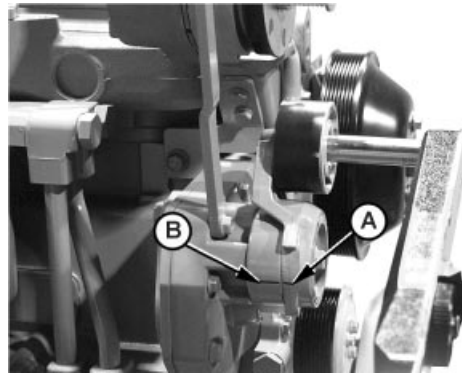

Align Marks

RG12054 -UN-08JAN02

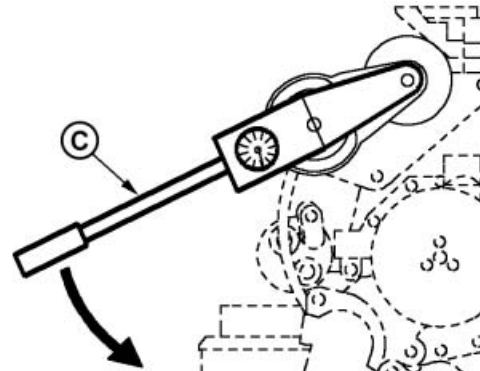

Align Torque Wrench With Pulley And Tensioner

RG12065 -UN-28JAN02

- A—Mark On Swing Arm
- B—Mark On Tensioner Mounting Base
- C—Torque Wrench

OURGP12,000004A -19-28JUL04-3/3



## Checking Engine Speeds

Observe tachometer (A) reading on the instrument panel to verify engine speeds while running engine. (Refer to Specifications section later in this manual for engine speed specifications.) If engine speeds need adjustment, contact your engine dealer or distributor.

A—Tachometer

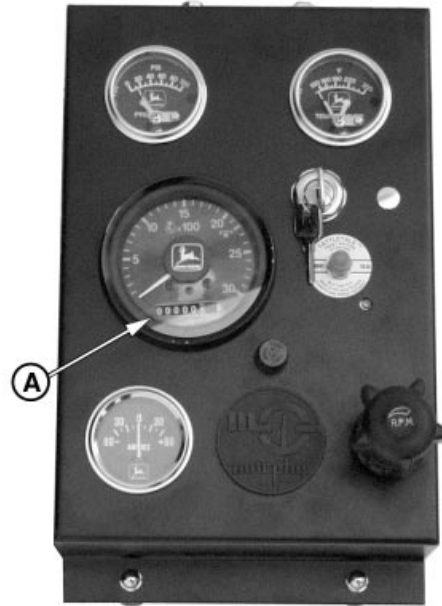

Check Engine Speed On Tachometer

RG11299A -JUN-17AUG00

OURGP11,000000B -19-24JUN04-1/1

## Checking Engine Electrical Ground Connections

Keep all engine ground connections clean and tight to prevent electrical arcing which can damage electronic components.

OUOD002,0000169 -19-08OCT01-1/1

## Checking Cooling System



**CAUTION:** Explosive release of fluids from pressurized cooling system can cause serious burns.

Shut off engine. Only remove filler cap when cool enough to touch with bare hands. Slowly loosen cap to first stop to relieve pressure before removing completely.

**IMPORTANT:** Air must be expelled from cooling system when system is refilled. Loosen temperature sending unit fitting at rear of cylinder head or plug in thermostat housing to allow air to escape when filling system. Retighten fitting or plug when all the air has been expelled.

1. Visually check entire cooling system for leaks. Tighten all clamps securely.
2. Thoroughly inspect all cooling system hoses for hard, flimsy, or cracked condition. Replace hoses if any of the above conditions are found.

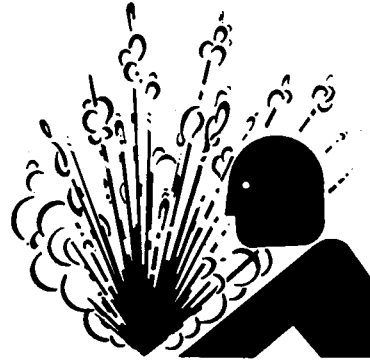

*High-Pressure Fluids*

TSS281 -JUN-23AUG88

RG, RG34710, 5580 -19-20MAY96-1/1

## Replenishing Supplemental Coolant Additives (SCAs) Between Coolant Changes

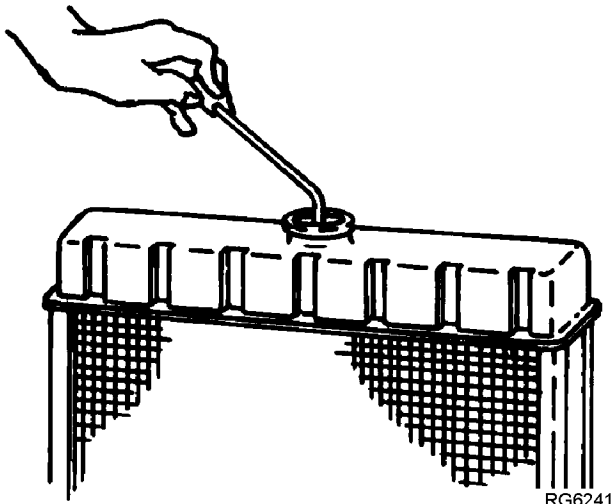

Radiator Coolant Check

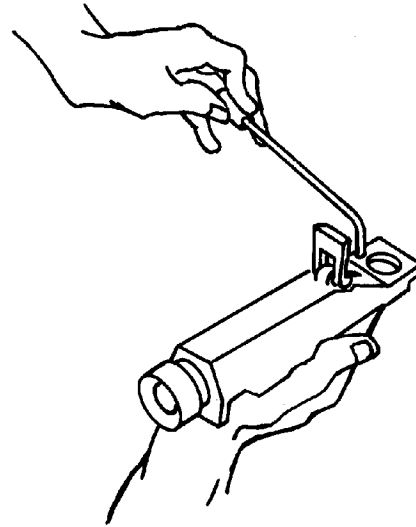

JT07298 Coolant/Battery Tester

**IMPORTANT:** Do not add supplemental coolant additives when the cooling system is drained and refilled with John Deere COOL-GARD®

*NOTE:* If system is to be filled with coolant that does not contain SCAs, the coolant must be precharged. Determine the total system capacity and premix with 3% John Deere Coolant Conditioner.

Through time and use, the concentration of coolant additives is gradually depleted during engine operation. Periodic replenishment of inhibitors is required, even when John Deere COOL-GARD® is used. The cooling system must be recharged with additional supplemental coolant additives available in the form of liquid coolant conditioner.

Maintaining the correct coolant conditioner concentration (SCAs) and freeze point is essential in

your cooling system to protect against rust, liner pitting and corrosion, and freeze-ups due to incorrect coolant dilution.

**John Deere LIQUID COOLANT CONDITIONER is recommended as a supplemental coolant additive in John Deere engines.**

**DO NOT mix one brand of SCA with a different brand.**

Test the coolant solution every 500 hours or 12 months of operation using either John Deere coolant test strips or a COOLSCAN® analysis. If a COOLSCAN® analysis is not available, recharge the system per instructions printed on label of John Deere Liquid Coolant Conditioner.

COOL-GARD is a registered trademark of Deere & Company  
COOLSCAN is a registered trademark of Deere & Company

Continued on next page

DPSG,OUOD002,1921 -19-07JAN02-1/2

**IMPORTANT: ALWAYS maintain coolant at correct level and concentration. DO NOT operate engine without coolant even for a few minutes.**

**If frequent coolant makeup is required, the glycol concentration should be checked with JTO7298 Coolant/Battery Tester to ensure that the desired freeze point is maintained. Follow manufacturer's instructions provided with Coolant/Battery Tester.**

Add the manufacturer's recommended concentration of supplemental coolant additive. DO NOT add more than the recommended amount.

The use of non-recommended supplemental coolant additives may result in additive drop-out and gelation of the coolant.

If other coolants are used, consult the coolant supplier and follow the manufacturer's recommendation for use of supplemental coolant additives.

See DIESEL ENGINE COOLANTS AND SUPPLEMENTAL ADDITIVE INFORMATION for proper mixing of coolant ingredients before adding to the cooling system.

DPSG,OUOD002,1921 -19-07JAN02-2/2

## Testing Diesel Engine Coolant

### Testing Diesel Engine Coolant

Maintaining adequate concentrations of glycol and inhibiting additives in the coolant is critical to protect the engine and cooling system against freezing, corrosion, and cylinder liner erosion and pitting.

Test the coolant solution at intervals of 12 months or less and whenever excessive coolant is lost through leaks or overheating.

### Coolant test strips

Coolant test strips are available from your John Deere dealer. These test strips provide a simple, effective

method to check the freeze point and additive levels of your engine coolant.

Compare the results to the supplemental coolant additive (SCA) chart to determine the amount of inhibiting additives in your coolant and whether more John Deere COOLANT CONDITIONER should be added.

### COOLSCAN™ and COOLSCAN PLUS™

For a more thorough evaluation of your coolant, perform a COOLSCAN or COOLSCAN PLUS analysis, where available. See your John Deere dealer for information.

*COOLSCAN is a trademark of Deere & Company  
COOLSCAN PLUS is a trademark of Deere & Company*

DX,COOL9 -19-19DEC03-1/1

## Pressure Testing Cooling System

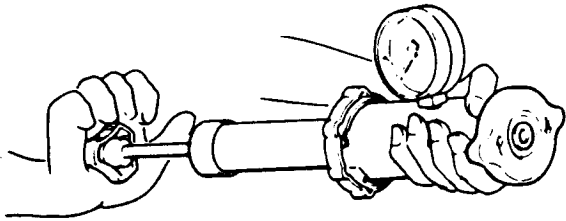

Test Radiator Cap

RG6657 -JUN-20JAN93

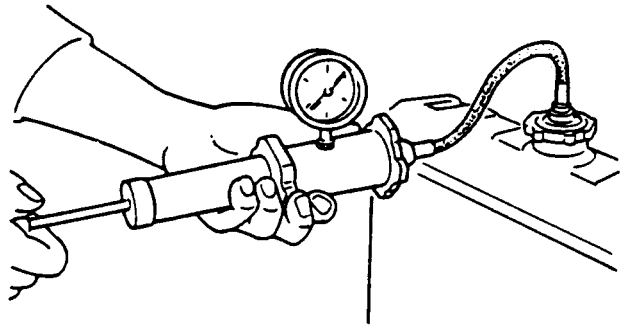

Test Cooling System

RG6558 -JUN-20JAN93

**CAUTION:** Explosive release of fluids from pressurized cooling system can cause serious burns.

Shut off engine. Only remove filler cap when cool enough to touch with bare hands. Slowly loosen cap to first stop to relieve pressure before removing completely.

### Test Radiator Cap

1. Remove radiator cap and attach to D05104ST Tester as shown.
2. Pressurize cap to specification listed. Gauge should hold pressure for 10 seconds within the normal range if cap is acceptable.

If gauge does not hold pressure, replace radiator cap.

#### Specification

Radiator Cap Holding Pressure  
(Not Opening For 10  
Seconds)—Pressure..... 70 kPa (0.7 bar) (10 psi)  
minimum

3. Remove the cap from gauge, turn it 180°, and retest cap. This will verify that the first measurement was accurate.

### Test Cooling System

**NOTE:** Engine should be warmed up to test overall cooling system.

1. Allow engine to cool, then carefully remove radiator cap.
2. Fill radiator with coolant to the normal operating level.

**IMPORTANT:** DO NOT apply excessive pressure to cooling system, doing so may damage radiator and hoses.

3. Connect gauge and adapter to radiator filler neck. Pressurize cooling system to specification listed for radiator cap.
4. With pressure applied, check all cooling system hose connections, radiator, and overall engine for leaks.

If leakage is detected, correct as necessary and pressure test system again.

If no leakage is detected, but the gauge indicated a drop in pressure, coolant may be leaking internally within the system or at the block-to-head gasket. Have your engine distributor or servicing dealer correct this problem immediately.

# Lubrication & Maint./2000 Hour/24 Month

## Adjusting Variable Speed (Droop) on Generator Set Engines

### Stanadyne Mechanical Injection Pumps Only

1. Warm engine to normal operating temperature.
2. When necessary, disconnect throttle linkage or cable.
3. Adjust slow idle (C) and adjust fast idle (B) speed when necessary.
4. Run engine at fast idle, then apply load until reaching rated speed.
5. Check power. Adjust with the screw (A) if needed.
6. Remove load from engine.
7. Again check and adjust fast idle if screw (A) has been turned.
8. Repeat procedure until both the engine power and the fast idle speed are correct.
9. Reinstall throttle linkage if previously removed.

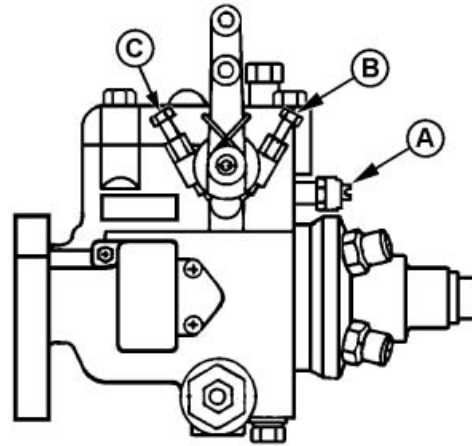

*Droop Adjustment Screw*

- A—Adjustment Screw
- B—Fast Idle Adjustment
- C—Slow Idle Adjustment

RG12066 -JUN-29JAN02

Continued on next page

RG, RG34710, 5583 -19-28JAN02-1/3

### DENSO In-Line Injection Pumps Only

1. Check for specified no-load (frequency). If governor regulation is within 5–7% range, no adjustment is necessary.
2. If governor regulation is above 7% or below 5%, stop engine and remove cap nuts from adjusting screws before making adjustments.
3. Remove droop adjusting screw access plug (B, shown removed) from top of governor housing.
4. Back out slow idle (adjusting) screw (D) and bumper screw. Pull back on throttle lever (F, toward rear of governor housing) by hand until the droop adjusting screw (C) inside housing can be adjusted through the access plug hole.
5. Screw the droop screw in (clockwise), counting the turns until screw bottoms out. Then, return screw to original setting.

**NOTE:** A noticeable click will occur at each 1/4 turn of droop adjusting screw. One click clockwise will increase no-load speed approximately 10 rpm, counterclockwise will reduce speed by 10 rpm.

6. Screw in the droop screw (clockwise) no more than 1/2 turn (two clicks) at a time to reduce governor droop. Turn counterclockwise no more than two clicks at a time to increase governor droop (to reduce governor sensitivity).
7. Replace access plug in top of governor housing. Start engine, apply full (100%) load, and readjust high idle adjusting screw until 1500 rpm is obtained at the specified power.
8. Screw in idle (bumper) spring until engine speed increases 5–10 rpm.
9. Repeat steps 4 through 7 until governor regulation is within the 5–7% range.
10. Replace all cap nuts onto adjusting screws and tighten lock nuts securely.

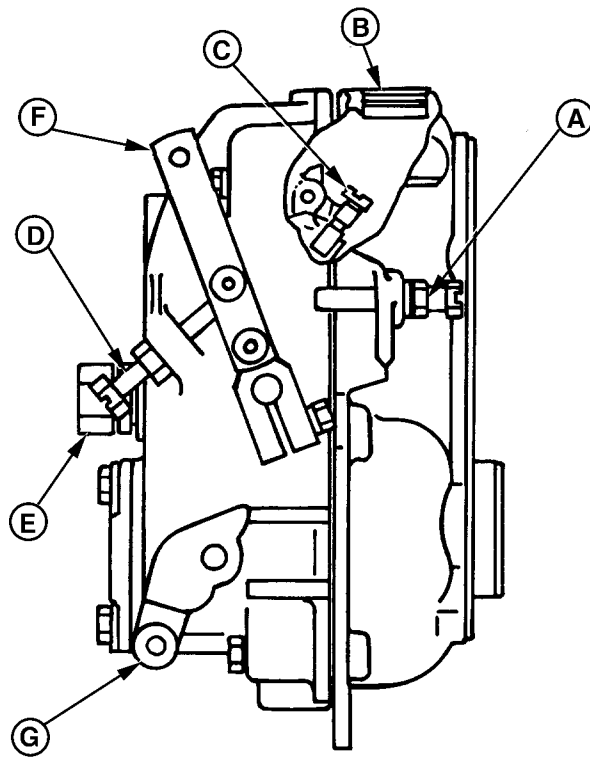

DENSO In-Line Injection Pump

- A—Fast Idle (Stop) Screw
- B—Droop Adjusting Screw Access Plug Location
- C—Droop Adjusting Screw
- D—Slow Idle (Adjusting) Screw
- E—Idle (Bumper) Spring
- F—Throttle Lever
- G—Mechanical Shutoff Lever

RG5752 -UN-03NOV97

Continued on next page

RG, RG34710, 5583 -19-28JAN02-2/3

### Delphi (Lucas) Injection Pumps Only

See your authorized Delphi (Lucas) Repair Station for speed droop adjustment. This service requires that an internal pump adjustment be made.

RG, RG34710, 5583 -19-28JAN02-3/3

### Checking Crankshaft Vibration Damper (6-Cylinder Engine Only)

1. Remove belts (shown removed).
2. Grasp vibration damper with both hands and attempt to turn it in both directions. If rotation is felt, damper is defective and should be replaced.

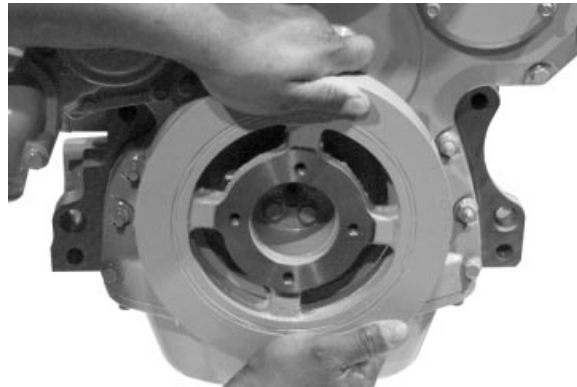

Grasp Vibration Damper

RG8018 -UN-15JAN99

**IMPORTANT: The vibration damper assembly is not repairable and should be replaced every 4500 hours or 60 months, whichever occurs first.**

3. Check vibration damper radial runout by positioning a dial indicator (A) so probe contacts damper outer diameter.
4. With engine at operating temperature, rotate crankshaft using either JDE83 or JD81-1 Flywheel Turning Tool.
5. Note dial indicator reading. If runout exceeds specifications given below, replace vibration damper.

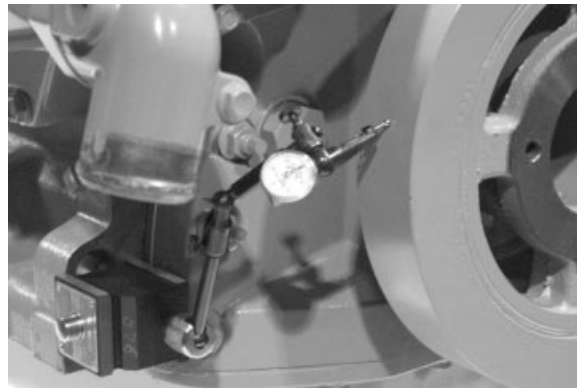

Check Runout

RG7508 -UN-23NOV97

#### Specification

Vibration Damper—Maximum  
 Radial Runout..... 1.50 mm (0.060 in.)

RG, RG34710, 5585 -19-16JAN02-1/1



## Flushing and Refilling Cooling System

**CAUTION:** Explosive release of fluids from pressurized cooling system can cause serious burns.

Shut off engine. Only remove filler cap when cool enough to touch with bare hands. Slowly loosen cap to first stop to relieve pressure before removing completely.

**NOTE:** When John Deere COOL-GARD is used, the drain interval is 3000 hours or 36 months. The drain interval may be extended to 5000 hours or 60 months of operation, **provided that the coolant is tested annually AND additives are replenished, as needed, by adding a supplemental coolant additive (SCA).**

If COOL-GARD is not used, the flushing interval is 2000 hours or 24 months of operation.

Drain old coolant, flush the entire cooling system, test thermostats, and fill with recommended clean coolant per the following procedure.

1. Pressure test entire cooling system and pressure cap if not previously done. (See PRESSURE TESTING COOLING SYSTEM, in the Lubrication and Maintenance/500 Hour/12 Month Section.)
2. Slowly open the engine cooling system filler cap or radiator cap (A) to relieve pressure and allow coolant to drain faster.



High-Pressure Fluids

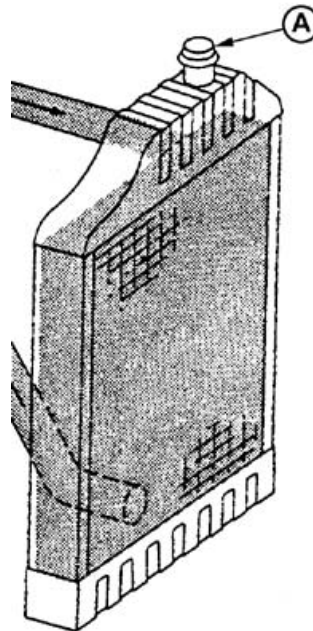

Radiator Cap

RG12833 -UN-13FEB03

T5281 -UN-23AUG88

Continued on next page

OURGP11,000000C -19-24JUN04-1/3

- Open engine block drain valve (A) on left side of engine. Drain all coolant from engine block.

**NOTE:** These engines use several different oil filter adapters. Use either drain plug (B) or (C) to drain coolant, whichever is more accessible for the oil filter adapter on your engine.

- Open radiator drain valve. Drain all coolant from radiator.
- Remove thermostats at this time, if not previously done. Install cover (without thermostats) using old gasket and tighten cap screws to 47 N•m (35 lb-ft).
- Test thermostat opening temperature. (See Inspecting Thermostats And Testing Opening Temperature in Service As Required Section.)
- Close all drain valves after coolant has drained.

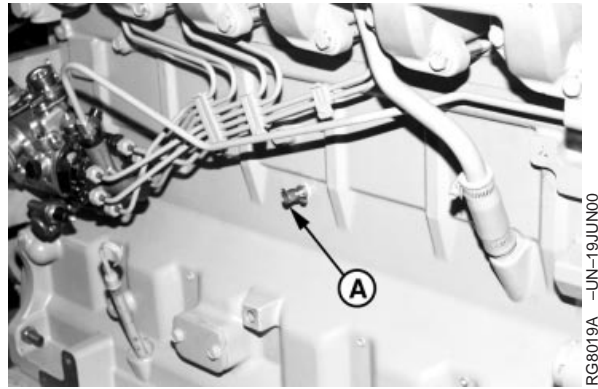

Engine Block Drain Valve

- A—Engine Block Drain Valve
- B—Engine Block Drain Plug
- C—Engine Block Drain Plug

**CAUTION:** Do not run engine longer than 10 minutes. Doing so may cause engine to overheat which may cause burns when radiator water is draining.

- Fill the cooling system with clean water. Run the engine about 10 minutes to stir up possible rust or sediment.
- Stop engine, pull off lower radiator hose and remove radiator cap. Immediately drain the water from system before rust and sediment settle.
- After draining water, close drain valves. Reinstall radiator cap and radiator hose and clamp. Fill the cooling system with clean water and a heavy duty cooling system cleaner such as Fleetguard® RESTORE™ and RESTORE PLUS™. Follow manufacturer's directions on label.

Fleetguard is a trademark of Cummins Engine Company, Inc.  
 RESTORE is a trademark of Fleetguard.  
 RESTORE PLUS is a trademark of Fleetguard.

Continued on next page

OURGP11,000000C -19-24JUN04-2/3

11. After cleaning the cooling system, drain cleaner and fill with water to flush the system. Run the engine about 10 minutes, remove radiator cap and pull off lower radiator hose to drain out flushing water.
12. Close all drain valves on engine and radiator. Reinstall radiator hose and tighten clamps securely. Install thermostats using a new gasket. (See TESTING THERMOSTATS OPENING TEMPERATURE later in this section.)

**IMPORTANT: Air must be expelled from cooling system when system is refilled. Loosen temperature sending unit fitting at rear of cylinder head or plug in thermostat housing to allow air to escape when filling system. Retighten fitting or plug after filling cooling system.**

*NOTE: Coolant capacity may vary depending on application.*

13. Add coolant to radiator until coolant touches bottom of filler neck. (See specification for capacity.) Install radiator cap.

**Specification**

4.5 L Engine— Coolant Capacity .....	8.5 L (9 qt)
6.8 L Engine—Coolant Capacity .....	11.3 L (12 qt)

14. Run engine until it reaches operating temperature. This mixes the solution uniformly and circulates it through the entire system. The normal engine coolant temperature range is 82°—94°C (180° — 202°F).
15. After running engine, check coolant level and entire cooling system for leaks.
16. Inspect the fan belt for wear and check belt tension. (See Checking Belt Tensioner Spring Tension and Belt Wear in Lubrication and Maintenance 500 Hour/12 Month section.

## Testing Thermostats Opening Temperature

### To Remove Thermostat(s)

*NOTE: On some engines, the coolant manifold/thermostat housing is an integral part of the cylinder head.*

**CAUTION:** Explosive release of fluids from pressurized cooling system can cause serious burns. **DO NOT** drain coolant until it has cooled below operating temperature. Always loosen radiator pressure cap or drain valve slowly to relieve pressure.

1. Visually inspect area around thermostat housing for leaks.
2. Remove radiator pressure cap and partially drain cooling system.
3. Remove thermostat cover-to-water pump tube (A) and seal.

**A**—Cover-To-Coolant Pump Tube



High Pressure Fluids



Thermostat Cover-to-Water Pump Tube

T5281 -UN-23AUG88

RG8115A -UN-15JAN88

DPSG, RG34710, 112 -19-07JAN02-1/5

4. Remove thermostat cover (B) with gasket.
5. Remove thermostat(s)
6. Remove and discard all gasket material. Clean gasket surfaces.
7. Clean and check cover for cracks or damage.

**B**—Thermostat Cover

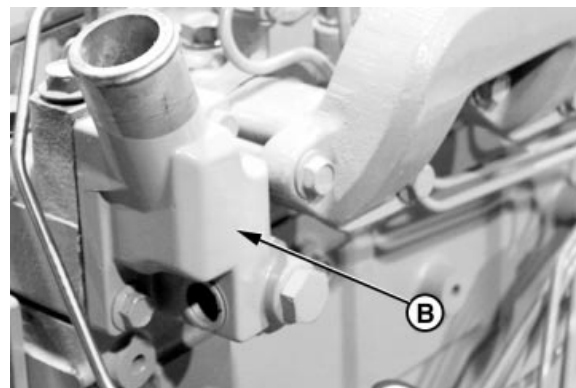

Thermostat Cover

RG7921A -UN-13NOV97

Continued on next page

DPSG, RG34710, 112 -19-07JAN02-2/5

### Testing Thermostats Opening Temperature

1. Remove thermostat(s).
2. Visually inspect thermostat(s) for corrosion or damage. If dual thermostats, replace as a matched set as necessary.

**CAUTION:** DO NOT allow thermostat or thermometer to rest against the side or bottom of container when heating water. Either may rupture if overheated.

3. Suspend thermostat and a thermometer in a container of water.
4. Stir the water as it heats. Observe opening action of thermostat and compare temperatures with the specification given in chart below.

**NOTE:** Due to varying tolerances of different suppliers, initial opening and full open temperatures may vary slightly from specified temperatures.

#### THERMOSTAT TEST SPECIFICATIONS

Rating	Initial Opening (Range)	Full Open (Nominal)
71°C (160°F)	69—72°C (156—162°F)	84°C (182°F)
77°C (170°F)	74—78°C (166—172°F)	89°C (192°F)
82°C (180°F)	80—84°C (175—182°F)	94°C (202°F)
89°C (192°F)	86—90°C (187—194°F)	101°C (214°F)
90°C (195°F)	89—93°C (192—199°F)	103°C (218°F)
92°C (197°F)	89—93°C (193—200°F)	105°C (221°F)
96°C (205°F)	94—97°C (201—207°F)	100°C (213°F)
99°C (210°F)	96—100°C (205—212°F)	111°C (232°F)

5. Remove thermostat and observe its closing action as it cools. In ambient air the thermostat should close completely. Closing action should be smooth and slow.
6. Replace any defective thermostat. On a dual thermostat engine, replace both thermostats.

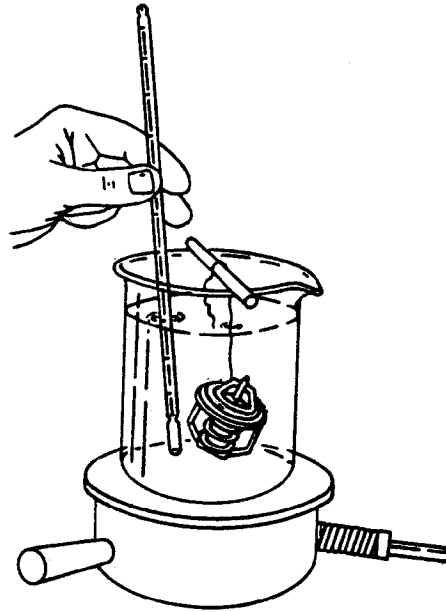

Testing Thermostat Opening Temperature

RG5971 -JUN-23NOV97

Continued on next page

DPSG, RG34710, 112 -19-07JAN02-3/5

### To Install Thermostats

**IMPORTANT:** Install manifold gasket so that smaller (round) holes are at lower left and upper right corners of manifold (matching studs A).

1. Clean all gasket material from thermostat cover and housing mounting surfaces.
2. Using guide studs (A) to keep gasket in place, install a new gasket on cylinder head.
3. Install thermostat(s) with jiggle wire facing up in the 12 o'clock position.
4. Using a screwdriver to hold thermostat(s) in place, install thermostat(s) and water manifold/thermostat cover.
5. Tighten cover cap screws to 70 N•m (52 lb-ft).
6. Lubricate new O-ring with PT507 Multi-Purpose Grease. Install seal (B) in thermostat cover.

A—Guide Studs  
B—Seal

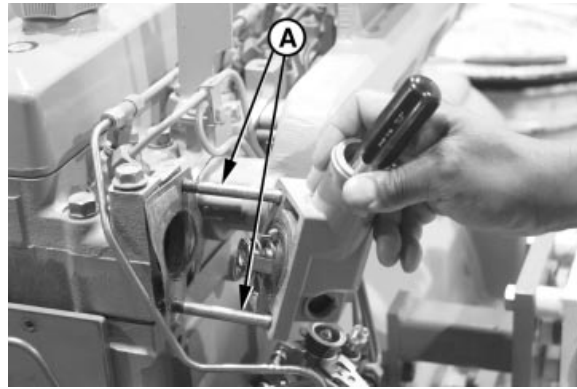

Installing Thermostat Cover

RG7614A -UN-06NOV97



Thermostat Cover Seal

RG7921B -UN-13NOV97

DPSG, RG34710, 112 -19-07JAN02-4/5

7. Install coolant manifold/thermostat cover-to-coolant pump tube (C). Tighten clamps.
8. If not already done, fill cooling system and check for leaks.

**IMPORTANT:** Air must be expelled from cooling system when filling. Loosen temperature sending unit fitting at rear of cylinder head or plug in thermostat housing to allow air to escape when filling system. Tighten fitting or plug when all air has been expelled.



Cover-To-Coolant Pump Tube

RG8115B -UN-15JAN98

C—Cover-To-Coolant Pump Tube

DPSG, RG34710, 112 -19-07JAN02-5/5

## Check and Adjust Valve Clearance

**CAUTION:** To prevent accidental starting of engine while performing valve adjustments, always disconnect **NEGATIVE (—)** battery terminal.

**IMPORTANT:** Valve clearance **MUST BE** checked and adjusted with engine **COLD**.

1. Remove rocker arm cover and crankcase ventilator tube.

**IMPORTANT:** Visually inspect contact surfaces of valve tips and rocker arm wear pads. Check all parts for excessive wear, breakage, or cracks. Replace parts that show visible damage.

Rocker arms that exhibit excessive valve clearance should be inspected more thoroughly to identify damaged parts.

2. Remove plastic plugs or cover plate from engine timing/rotation hole (A) and timing pin hole (B).

*NOTE: Some engines are equipped with flywheel housings which do not allow use of an engine flywheel rotation tool. These engines may be rotated from front nose of engine, using JDG966 Crankshaft Front/Rear Rotation Adapter.*

3. Using JDE83 or JD81-1 Flywheel Turning Tool, rotate engine flywheel in running direction (clockwise viewed from front) until No. 1 cylinder is at TDC compression stroke. Insert JDG1571 or JDE81-4 Timing Pin in flywheel.

If No.1 cylinder rocker arms are loose, the engine is at No. 1 TDC compression.

If No. 1 cylinder rocker arms are not loose, rotate engine one full revolution (360°) to No. 1 TDC compression.

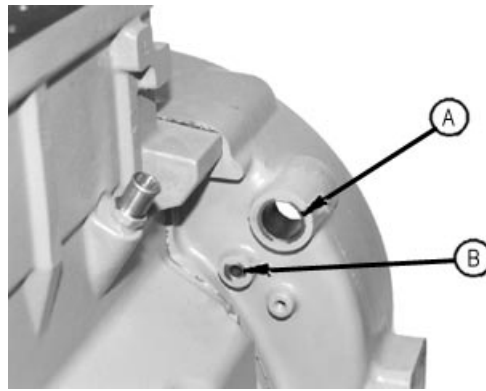

Flywheel Housing Timing Holes

A—Timing/Rotation Hole  
B—Timing Pin Hole

RG7408 -UN-06AUG96

Continued on next page

DPSG, RG41165, 137 -19-16JAN02-1/5

4. With engine lock-pinned at TDC of No. 1 piston's compression stroke, check valve clearance to following specifications. (Use sequence for 4-cylinder or 6-cylinder engines as outlined on next page.)

**Specification**

Intake Valve Clearance For	
Checking (Rocker Arm-to-Valve	
Tip) (Engine Cold)—Clearance .....	0.31—0.38 mm (0.012—0.015 in.)
Exhaust Valve Clearance For	
Checking (Rocker Arm-to-Valve	
Tip) (Engine Cold)—Clearance .....	0.41—0.48 mm (0.016—0.019 in.)

DPSG, RG41165, 137 -19-16JAN02-2/5

5. If valves need adjusting, use the appropriate valve clearance adjustment procedure on the next page and adjust to specifications below. Loosen the jam nut (A) on rocker arm adjusting screw. Turn adjusting screw until feeler gauge slips with a slight drag. Hold the adjusting screw from turning with screwdriver and tighten jam nut to specifications. Recheck clearance again after tightening jam nut. Readjust clearance as necessary.

**Specification**

Intake Valve Clearance For	
Adjusting (Rocker Arm-to-Valve	
Tip) (Engine Cold)—Clearance .....	0.36 mm (0.014 in.)
Exhaust Valve Clearance For	
Adjusting (Rocker Arm-to-Valve	
Tip) (Engine Cold)—Clearance .....	0.46 mm (0.018 in.)
Rocker Arm Adjusting Screw Jam	
Nut—Torque .....	27 N•m (20 lb-ft)

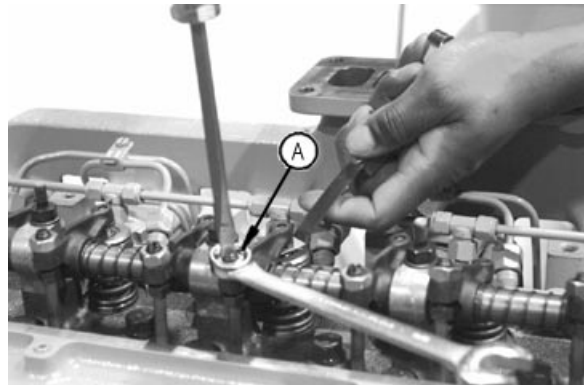

RG7409 -UN-06AUG96

*Adjusting Valves*

**A—Adjusting Screw Jam Nut**

6. Replace rocker arm cover and crankcase ventilator tube.

Continued on next page

DPSG, RG41165, 137 -19-16JAN02-3/5



### 4-Cylinder Engine:

*NOTE: Firing order is 1-3-4-2.*

1. Using JDE81-4 Timing Pin, lock No. 1 piston at TDC compression stroke (B).
2. Adjust valve clearance on No. 1 and 3 exhaust valves and No. 1 and 2 intake valves.
3. Turn crankshaft 360°. Lock No. 4 piston at TDC compression stroke (C).
4. Adjust valve clearance on No. 2 and 4 exhaust valves and No. 3 and 4 intake valves.

A—Front of Engine  
 B—No. 1 Piston TDC Compression  
 C—No. 4 Piston TDC Compression  
 E—Exhaust Valve  
 I—Intake Valve

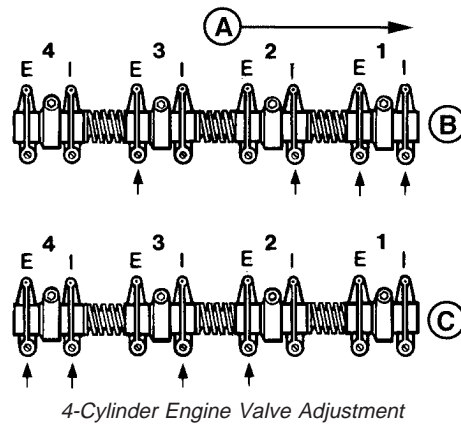

RG4776 -UN-31OCT97

4-Cylinder Engine Valve Adjustment

DPSG, RG41165,137 -19-16JAN02-4/5

### 6-Cylinder Engine:

*NOTE: Firing order is 1-5-3-6-2-4.*

1. Lock No. 1 piston at TDC compression stroke (B).
2. Adjust valve clearance on No. 1, 3 and 5 exhaust valves and No. 1, 2, and 4 intake valves.
3. Turn crankshaft 360°. Lock No. 6 piston at TDC compression stroke (C).
4. Adjust valve clearance on No. 2, 4 and 6 exhaust valves and No. 3, 5, and 6 intake valves.

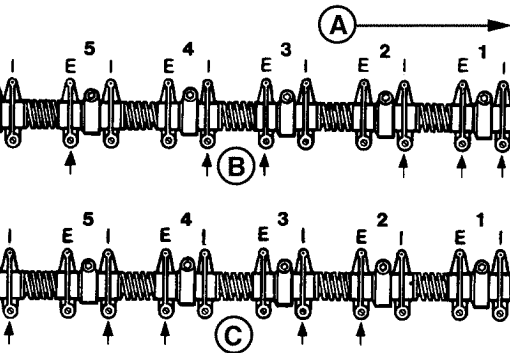

RG4777 -UN-31OCT97

6-Cylinder Engine Valve Adjustment

A—Front of Engine  
 B—No. 1 Piston TDC Compression  
 C—No. 6 Piston TDC Compression  
 E—Exhaust Valve  
 I—Intake Valve

DPSG, RG41165,137 -19-16JAN02-5/5

# Service as Required

## Additional Service Information

This is not a detailed service manual. If you want more detailed service information, use the form in the back of this manual to order a component technical manual.

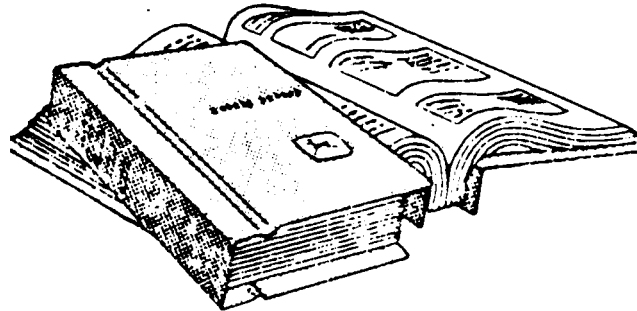

*Component Technical Manual*

RG4624 -UN-15DEC88

RG, RG34710, 5591 -19-20MAY96-1/1

## Do Not Modify Fuel System

**IMPORTANT:** Modification or alteration of the injection pump (arrow), the injection pump timing, or the fuel injectors in ways not recommended by the manufacturer will terminate the warranty obligation to the purchaser.

In addition, tampering with fuel system which alters emission-related equipment on engines may result in fines or other penalties, per EPA regulations or other local emission laws.

Do not attempt to service injection pump or fuel injectors yourself. Special training and special tools are required. (See your authorized servicing dealer or engine distributor.)

Never steam clean or pour cold water on an injection pump while it is still warm. To do so may cause seizure of pump parts.

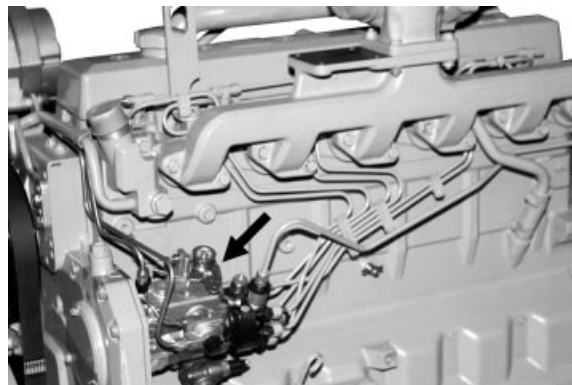

*Fuel Injection Pump*

RG6022A -UN-19JUN00

OURGP12,000004D -19-03AUG04-1/1

## Adding Coolant

**CAUTION:** Explosive release of fluids from pressurized cooling system can cause serious burns.

Shut off engine. Only remove filler cap when cool enough to touch with bare hands. Slowly loosen cap to first stop to relieve pressure before removing completely.

**IMPORTANT:** Never pour cold liquid into a hot engine, as it may crack cylinder head or block. DO NOT operate engine without coolant for even a few minutes.

John Deere TY15161 Cooling System Sealer may be added to the radiator to stop leaks. DO NOT use any other stop-leak additives in the system.

Air must be expelled from cooling system when coolant is added.

1. Loosen temperature sending unit fitting at rear of cylinder head or plug in side of thermostat housing to allow air to escape when filling system.

**IMPORTANT:** When adding coolant to the system, use the appropriate coolant solution. ( See ENGINE COOLANT SPECIFICATIONS in Fuels, Lubricants, and Coolant Section for mixing of coolant ingredients before adding to cooling system.)

Do not overfill cooling system. A pressurized system needs space for heat expansion without overflowing at top of radiator.

2. Remove radiator cap (A) and fill until coolant level touches bottom of radiator filler neck.
3. Tighten plugs and fittings when air has been expelled from system.
4. Run engine until it reaches operating temperature.

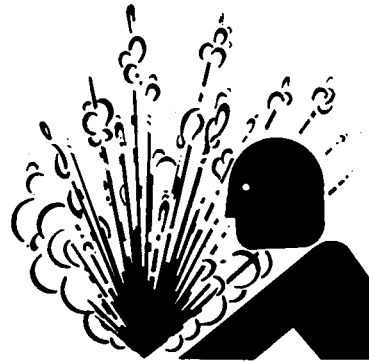

High-Pressure Fluids

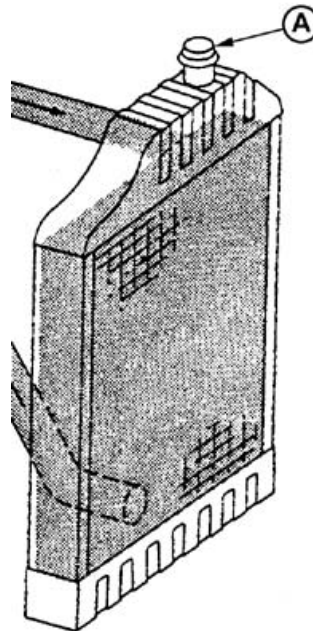

Radiator Filler Cap

A—Radiator Filler Cap

TSS281 -UN-23AUG88

RG12833 -UN-13FEB03

OURGP12.0000049 -19-22JUL04-1/1

## Replacing Single Stage Air Cleaner

**IMPORTANT:** ALWAYS REPLACE air cleaner when air restriction indicator shows a vacuum of 625 mm (25 in.) H<sub>2</sub>O, is torn, or visibly dirty.

*NOTE: This procedure applies to John Deere single stage air cleaner kits. Refer to manufacturers' instructions for servicing air cleaners not supplied by John Deere.*

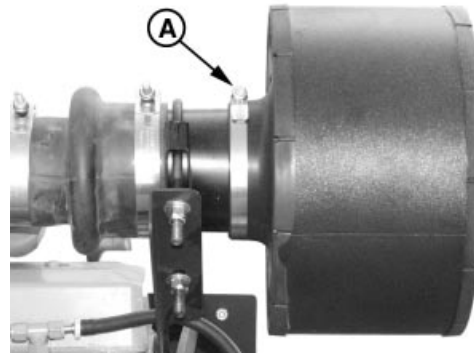

Single Stage Air Filter

1. If equipped, loosen body clamp.
2. Loosen clamp around outlet neck (A).
3. Remove air cleaner.
4. Install new filter so that overlap (B) of air cleaner outlet neck and engine intake pipe is to specification below.

**Specification**

Air Cleaner Neck to Engine Intake—Overlap..... 38 mm (1.5 in)

5. Tighten neck clamp (A) to specification below.

**Specification**

Air Cleaner Neck Clamp—Torque..... 6.8 N•m (60 lb-in.)

**IMPORTANT:** Do NOT overtighten body clamp. Overtightening may cause crushing of air cleaner body. Tighten body clamp only until snug.

6. If equipped, tighten body clamp until snug.

**IMPORTANT:** Whenever the air cleaner has been serviced or removed, ALWAYS fully depress the air restriction indicator reset button (if equipped) to assure accurate readings.

7. If equipped, fully depress air restriction indicator reset button and release to reset indicator.

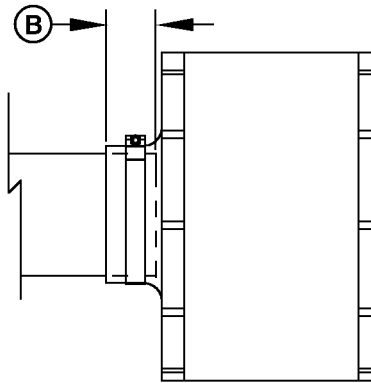

Installation of Single Stage Air Cleaner

**A—Outlet Neck Clamp**  
**B—Filter to Engine Overlap**

RG11319A -UN-06SEP00

RG11320 -UN-07SEP00

## Replacing Axial Seal Air Cleaner Filter Element

**IMPORTANT:** ALWAYS REPLACE primary air cleaner element when air restriction indicator shows a vacuum of 625 mm (25 in.) H<sub>2</sub>O, is torn, or visibly dirty.

*NOTE:* This procedure applies to John Deere 2-stage axial seal air cleaner kits. Refer to manufacturers' instructions for servicing air cleaners not supplied by John Deere.

1. Remove wing nut and remove canister cover shown in small illustration inset.
2. Remove wing nut (A) and remove primary element (B) from canister.
3. Thoroughly clean all dirt from inside canister.

*NOTE:* Some engines may have a dust unloader valve (C) on the air cleaner. If equipped, squeeze valve tip to release any trapped dirt particles.

**IMPORTANT:** Remove secondary (safety) element (E) ONLY for replacement. DO NOT attempt to clean, wash, or reuse secondary element. Replacement of secondary element is usually necessary ONLY when primary element has a hole in it.

4. To replace secondary element, remove retaining nut (D) and secondary element (E). Immediately replace secondary element with new element to prevent dust from entering air intake system.
5. Install new primary element and tighten wing nut securely. Install cover assembly and tighten retaining wing nut securely.

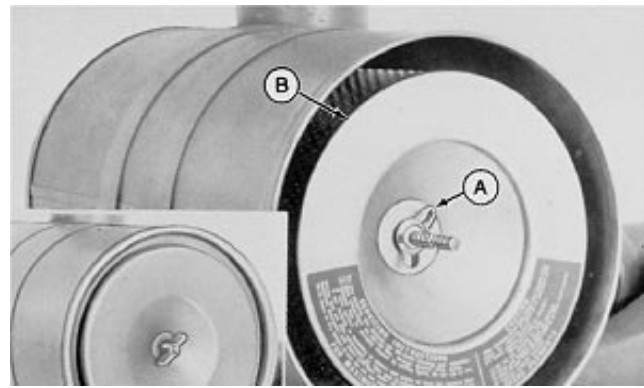

Wing Nut and Primary Element

RG4686 -UN-20DEC88

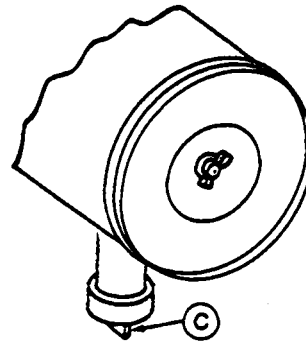

Dust Unloader Valve

RG4687 -UN-20DEC88

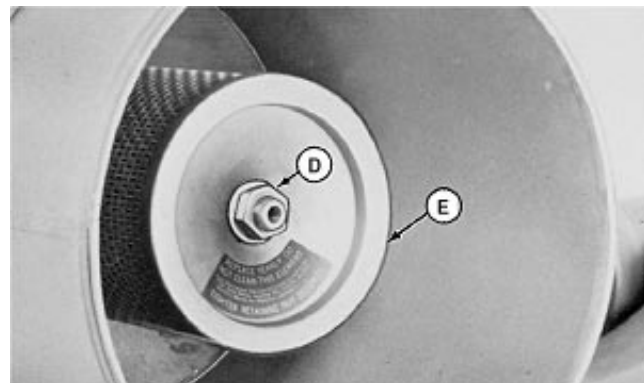

Retaining Nut and Secondary Element

RG11068 -UN-26JUN00

- A—Wing Nut
- B—Primary Element
- C—Dust Unloader Valve
- D—Retaining Nut
- E—Secondary Element

Continued on next page

RG41165,00008A -19-12NOV01-1/2

**IMPORTANT: Whenever the air cleaner has been serviced or had cover removed, ALWAYS fully depress the air restriction indicator reset button (if equipped) to assure accurate readings.**

6. If equipped, fully depress air restriction indicator reset button and release to reset indicator.

RG41165,000008A -19-12NOV01-2/2

## Replacing Radial Seal Air Cleaner Filter Element

**IMPORTANT:** ALWAYS REPLACE primary air cleaner element when air restriction indicator shows a vacuum of 625 mm (25 in.) H<sub>2</sub>O, is torn, or visibly dirty.

*NOTE:* This procedure applies to John Deere 2-stage radial seal air cleaner kits. Refer to manufacturers' instructions for servicing air cleaners not supplied by John Deere.

1. Unlatch and remove dust cup/cover (A) of air cleaner.
2. Move end of filter (B) back and forth gently to break seal.
3. Pull filter (B) off outlet tube and out of housing.
4. Thoroughly clean all dirt from inside housing and from outlet bore.

**IMPORTANT:** Remove secondary (safety) element (C) ONLY for replacement. DO NOT attempt to clean, wash, or reuse secondary element. Replacement of secondary element is usually necessary ONLY when primary element has a hole in it.

5. To replace secondary element (C), pull filter element out gently. Immediately replace secondary element with new element to prevent dust from entering air intake system.
6. Install new primary filter element. Apply pressure by hand at outer rim of filter.

**IMPORTANT:** Do NOT use latches on cover to force filter into air cleaner. Using cover to force filter will damage cleaner housing.

7. Close housing with dust unloader valve aimed down and latch latches.



Dust Cup/Cover

RG11321A -UN-08SEP00



Primary Filter Element

RG11322A -UN-08SEP00



Secondary Filter Element

RG11327A -UN-08SEP00

- A—Dust Cap/Cover
- B—Primary Filter Element
- C—Secondary Filter Element

Continued on next page

RG41165,000008B -19-27JUL06-1/2

**IMPORTANT:** Whenever the air cleaner has been serviced or cover has been removed, **ALWAYS** fully depress the air restriction indicator reset button (if equipped) to assure accurate readings.

8. If equipped, fully depress air restriction indicator reset button and release to reset indicator.

RG41165,000008B -19-27JUL06-2/2



## Replacing Fan and Alternator Belts

Refer to CHECKING BELT TENSIONER SPRING TENSION AND BELT WEAR in Lubrication and Maintenance/250 Hour/6 Month Section for additional information on the belt tensioner.

1. Inspect belts for cracks, fraying, or stretched out areas. Replace if necessary.
2. To replace belt with automatic tensioner, release tension on belt using a breaker bar and socket (if required) on tension arm.

To replace belt with manual tensioner, release tension at belt tensioner (See MANUAL BELT TENSIONER ADJUSTMENT in Lubrication and Maintenance/250 Hour/6 Month Section.)

3. Remove poly-vee belt from pulleys and discard belt.
4. Install new belt, making sure belt is correctly seated in all pulley grooves. Refer to belt routing at right for your application.
5. Apply tension to belt with tensioner. Remove socket.
6. Start engine and check belt alignment.

\*Measured from crank centerline to fan drive center.

A—Alternator  
 CSP—Crankshaft Pulley  
 FC—Freon (A/C) Compressor  
 FD—Fan Drive  
 I—Idler Pulley  
 T—Tensioner  
 CP—Coolant Pump

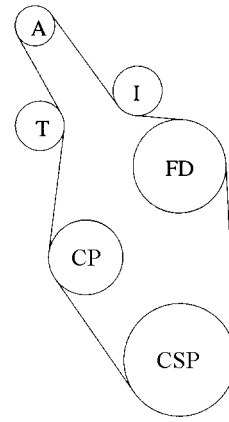

290 mm (11.4 in.) Fan Height and Lower\*

RG11950 -UN-07NOV01

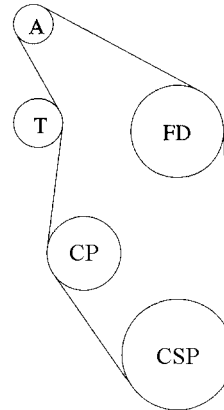

338 mm (13.3 in.) Fan Height and Higher Without Freon Compressor\*

RG11951 -UN-07NOV01

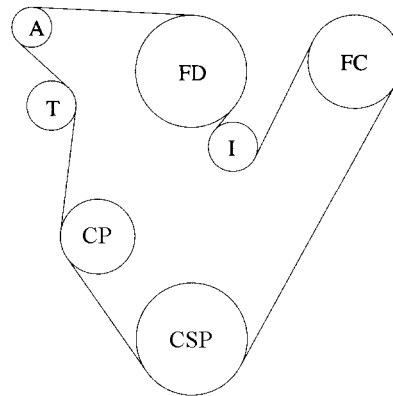

402 mm (15.8 in.) Fan Height With Freon Compressor\*

RG11952 -UN-07NOV01

OURGP12,000004C -19-29JUL04-1/1

## Checking Fuses In Instrument Panels

The following instructions apply to engines equipped with John Deere instrument panels.

1. **On Engines With The North American Standard Instrument Panel ( —1998)**, check the fuse (A) between the ammeter (B) and key switch (C) located on back side of instrument panel. If defective, replace with an equivalent 25-amp fuse.

Also check the fuse (D) mounted on the bottom of the magnetic safety switch. If defective, install an equivalent 14-amp fuse.

2. **On later (1999— ) North American Standard Instrument Panels**, check the fuse in fuse holder (E) on front face of instrument panel. Replace as necessary with an equivalent 14-amp fuse.
3. **For VDO Instrument Panels**, the fuse is located on the electronic control card inside the panel's rear access cover. Remove cover and check fuse (F). If defective, replace with a 10-amp fuse. There is a spare fuse (G) available on the card in the "SPARE" terminal.

**NOTE:** For main electrical system fuses, see engine wiring diagrams later in this manual in *Troubleshooting Section*.

- A—25 Amp Fuse
- B—Ammeter
- C—Key Switch
- D—14 Amp Fuse
- E—Fuse Holder
- F—10 Amp Fuse
- G—Spare Fuse

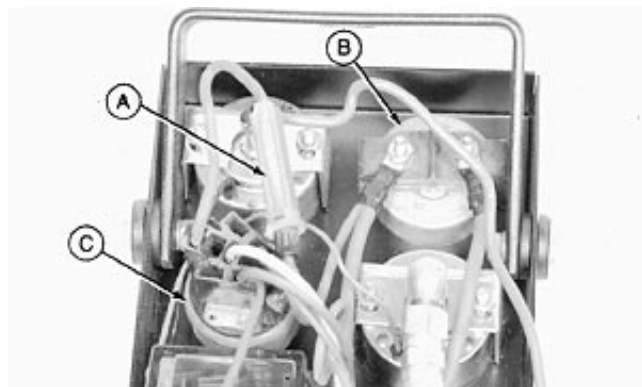

North American ( —1998) Standard Instrument Panel Shown

RG4483 —UN-14DEC88

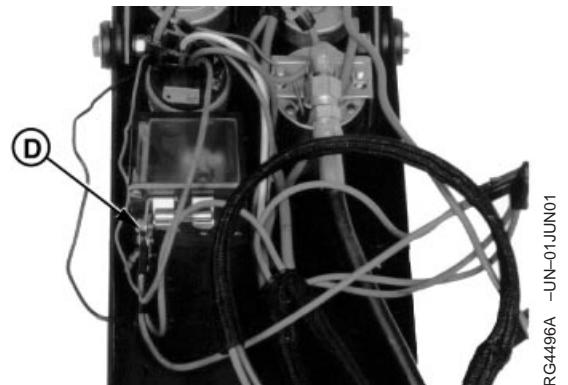

North American ( —1998) Standard Instrument Panel Shown

RG4486A —UN-01JUN01

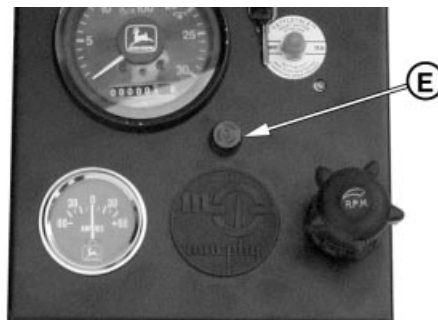

North American (1999— ) Instrument Panel Shown

RG11937 —UN-17OCT01

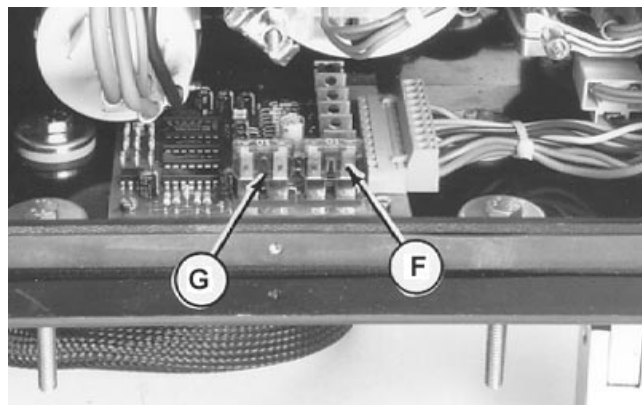

VDO Instrument Panel

RG12067 —UN-29JAN02

## Checking Air Compressor (If Equipped)

Air compressors are offered as options with John Deere OEM engines to provide compressed air to operate air-powered devices like vehicle air brakes.

Air compressors are engine-driven piston types. They are either air cooled or cooled with engine coolant. The compressors are lubricated with engine oil. The compressor runs continuously as gear or spline driven by the auxiliary drive of the engine but has "loaded" and "unloaded" operating modes. This is controlled by the vehicle's air system (refer to vehicle technical manual for complete air system checks and services).

See your John Deere engine distributor or servicing dealer for diagnostic and troubleshooting information. If diagnosis leads to an internal fault in the compressor, replace the complete compressor as a new or remanufactured unit.

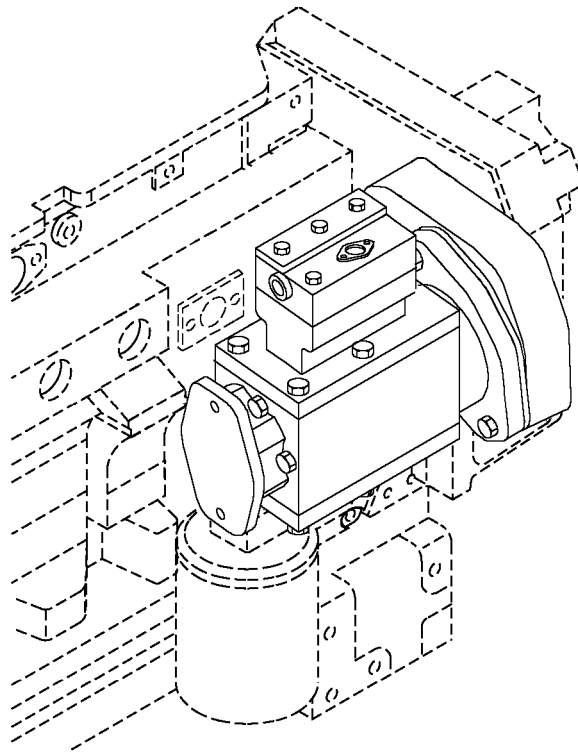

*Air Compressor (Optional)*

RG12836 -UN-27FEB03

OURGP12,00001E0 -19-26FEB03-1/1

## Bleeding the Fuel System



**CAUTION:** Escaping fluid under pressure can penetrate the skin causing serious injury. Relieve pressure before disconnecting fuel or other lines. Tighten all connections before applying pressure. Keep hands and body away from pinholes and nozzles which eject fluids under high pressure. Use a piece of cardboard or paper to search for leaks. Do not use your hand.

If ANY fluid is injected into the skin, it must be surgically removed within a few hours by a doctor familiar with this type injury or gangrene may result. Doctors unfamiliar with this type of injury may call the Deere & Company Medical Department in Moline, Illinois, or other knowledgeable medical source.

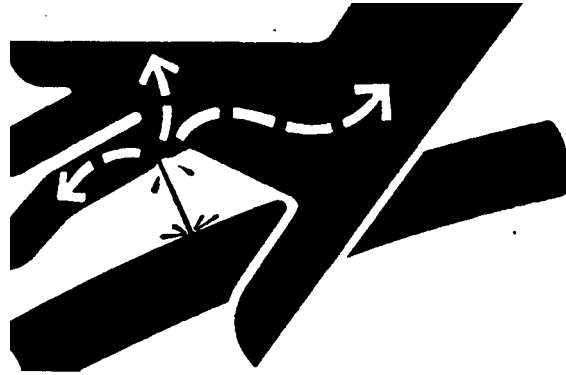

High-Pressure Fluids

X9811 -UN-23AUG88

Bleed the fuel system anytime the fuel system has been opened up. This includes:

- After fuel filter changes.
- After injection pump or nozzle replacement.
- Anytime fuel lines have been disconnected.
- After engine has run out of fuel.

**IMPORTANT:** DO NOT pressurize fuel tank to push fuel through system, as the pressure can damage fuel injection pump seals

Continued on next page

OURGP11,000000D -19-18OCT06-1/7

**IMPORTANT:** Do not operate the engine at high speeds or full loads just before bleeding the fuel system as this may cause fuel injection pump failure.

1. Loosen the air bleed vent screws (A) two full turns by hand on fuel filter base. (One screw with single filter option.)

**A—Air Bleed Vent Screws**

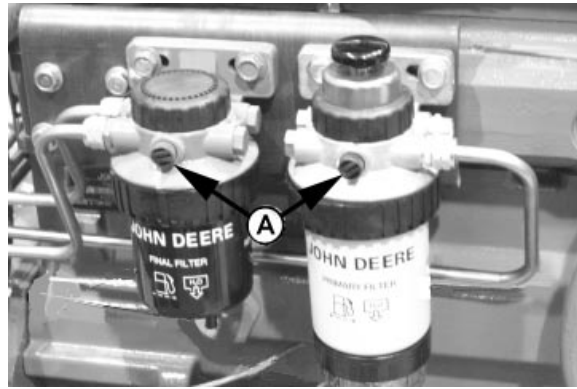

RG13544 -UN-29JUL04

*Air Bleed Vent Screws (Final Filter at Left, Primary Filter with Separator Bowl at Right)*

OURGP11,000000D -19-18OCT06-2/7

2. Operate supply pump primer lever (B) until fuel flow is free from air bubbles.
3. Tighten bleed plug securely, continue operating hand primer until pumping action is not felt. Push hand primer inward (toward engine) as far as it will go.
4. Start engine and check for leaks.

If engine will not start, it may be necessary to bleed air from fuel system at fuel injection pump or injection nozzles as explained next.

**B—Fuel Supply Pump Primer Lever**

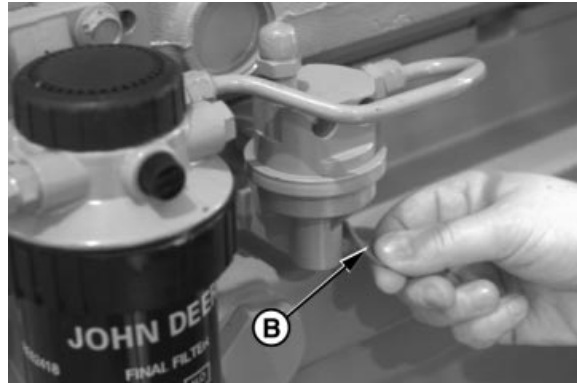

RG8013A -UN-15JAN99

*Fuel Supply Pump Primer Lever*

Continued on next page

OURGP11,000000D -19-18OCT06-3/7

### At Fuel Injection Pump

#### On Stanadyne rotary pumps:

1. Slightly loosen fuel return line connector (A) at fuel injection pump.
2. Operate fuel supply pump primer lever until fuel, without air bubbles, flows from fuel return line connection.
3. Tighten return line connector to 27 N•m (20 lb-ft).
4. Primer lever is spring-loaded and will return to normal position.

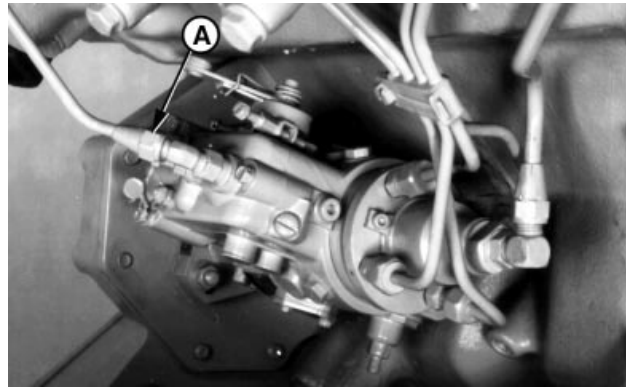

RG6264 -UN-03NOV97

Stanadyne Rotary Fuel Injection Pump

A—Fuel Return Line Connector

OURGP11,00000D -19-18OCT06-4/7

#### On Lucas rotary pumps:

1. Loosen bleed screw (B) on pump cover.

*NOTE: On Models DP200/201/203 Injection Pumps, bleed screw is located on top of cover near the fuel return line.*

2. Operate fuel supply pump primer lever or turn ignition switch to "ON".
3. Wait until fuel flow is free of air bubbles. Tighten bleed screw.
4. Primer lever is spring loaded and will return to normal position.

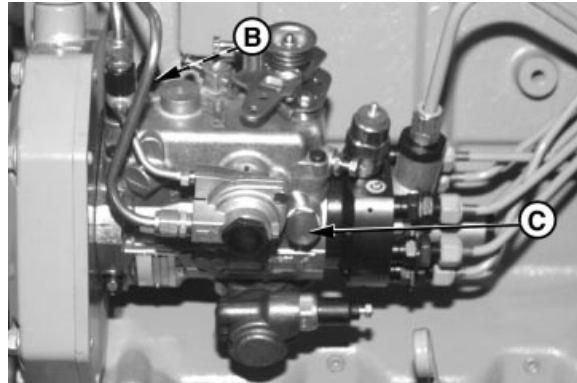

RG7948 -UN-13NOV97

Lucas Rotary Fuel Injection Pumps

B—Bleed Screw  
C—Screw

**!** **CAUTION: NEVER loosen screw (C) securing pump head, otherwise pump damage may occur.**

Continued on next page

OURGP11,00000D -19-18OCT06-5/7

**On DENSO and Motorpal in-line pumps:**

1. On DENSO pump shown, unscrew hand primer on fuel supply pump until it can be pulled by hand.
2. Open fuel filter port plug.
3. Operate the hand primer until a smooth flow of fuel, free of bubbles, comes out of the filter plug hole.
4. Simultaneously stroke the hand primer down and close the filter port plug. This prevents air from entering the system. Tighten plug securely. **DO NOT** overtighten.

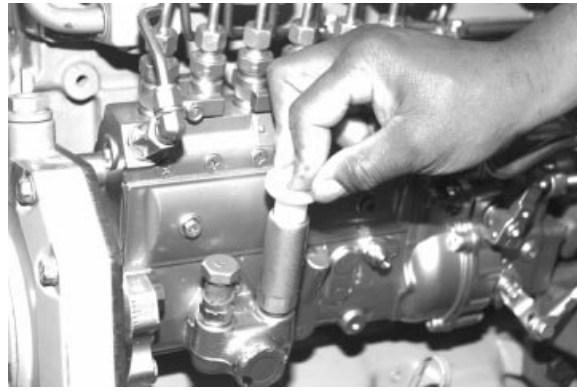

RG8069 -UN-23NOV97

*DENSO Fuel Injection Pump Shown*

**IMPORTANT: Be sure hand primer is all the way down in barrel before tightening to prevent internal thread damage.**

5. On DENSO pump shown, lock hand primer in position.

OURGP11,00000D -19-18OCT06-6/7

**At Fuel Injection Nozzles**

1. Move the engine speed control lever to half throttle position. On engines equipped with electronic fuel shut-off solenoid, energize solenoid.
2. Using **two** open-end wrenches, loosen fuel line connection at injection nozzle as shown.
3. Crank engine over with starter motor, (but do not start engine), until fuel free from bubbles flows out of loosened connection.
4. Retighten connection to 27 N•m (20 lb-ft).
5. Repeat procedure for remaining injection nozzles (if necessary) until all air has been removed from fuel system.

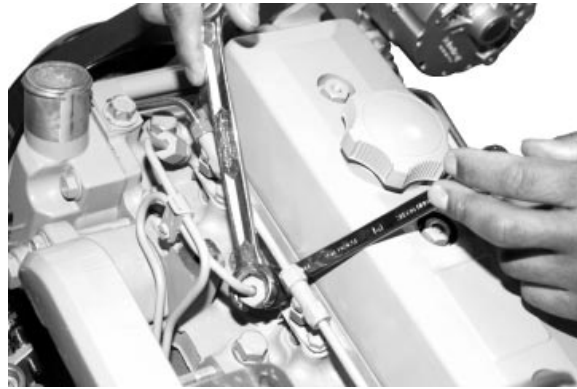

RG7725 -UN-08JAN97

*Fuel Line Connection*

If engine still will not start, see your authorized servicing dealer or engine distributor.

OURGP11,00000D -19-18OCT06-7/7

# Troubleshooting

## General Troubleshooting Information

Troubleshooting engine problems can be difficult. An engine wiring diagram is provided in this section to help isolate electrical problems on power units using John Deere wiring harness and instrument (gauge) panel.

Wiring diagrams are shown for the two types of instrument panels offered for these engines.

Later in this section is a list of possible engine problems that may be encountered accompanied by possible causes and corrections. The illustrated diagrams and troubleshooting information are of a general nature, final design of the overall system for your engine application may be different. See your engine distributor or servicing dealer if you are in doubt.

A reliable program for troubleshooting engine problems should include the following basic diagnostic thought process:

- Know the engine and all related systems.
- Study the problem thoroughly.
- Relate the symptoms to your knowledge of engine and systems.
- Diagnose the problem starting with the easiest things first.
- Double-check before beginning the disassembly.
- Determine cause and make a thorough repair.
- After making repairs, operate the engine under normal conditions to verify that the problem and cause was corrected.

RG, RG34710, 5605 -19-07JAN02-1/1





## Engine Wiring Diagram Legend (Standard Instrument Panel For North America)

<b>A1</b> — Speed Control Unit	<b>P6</b> — Ammeter
<b>B1</b> — Magnetic Speed Sensor	<b>R1</b> — Resistor (48 ohm) <sup>3</sup>
<b>B2</b> — Coolant Temperature Sensor	<b>S1</b> — Key Switch
<b>B3</b> — Oil Pressure Sensor	<b>S2</b> — Magnetic Safety Switch—North American
<b>F1</b> — Starting Circuit Fuse (14 amp)	Auto Override Module—European (Saran)
<b>F3</b> — Fuse (Early Models) <sup>1</sup>	<b>W1</b> — Ground on K1 Starter Relay Mounting Stud
<b>G1</b> — Battery	<b>Y1</b> — Starter Solenoid
<b>G2</b> — Alternator	<b>Y2</b> — Fuel Shut-off Solenoid
<b>H1</b> — Coolant Temperature Indicator Lamp	<b>BLK</b> — Black
<b>H2</b> — Oil Pressure Indicator Lamp	<b>BLU</b> — Blue
<b>H3</b> — Alternator Indicator Lamp	<b>BRN</b> — Brown
<b>K1</b> — Starter Relay	<b>DK BLU</b> — Dark Blue
<b>M1</b> — Starter Motor	<b>GRN</b> — Green
<b>P1</b> — Coolant Temperature Gauge	<b>ORG</b> — Orange
<b>P2</b> — Oil Pressure Gauge	<b>PUR</b> — Purple
<b>P3</b> — Crankcase Oil Level Switch/Gauge	<b>RED</b> — Red
<b>P4</b> — Tachometer <sup>1</sup>	<b>YEL</b> — Yellow
<b>P5</b> — Hourmeter (Early Models) <sup>2</sup>	

<sup>1</sup> P4 tachometer has a built-in hourmeter. On some earlier engines, a separate hourmeter (P5) and fuse (F3) were used.

<sup>2</sup> P4 tachometer has a built-in hourmeter. On some engines, a separate hourmeter (P5) and fuse (F3) are used.

<sup>3</sup> Later harnesses have two parallel 100 ohm resistors for the alternator.

Wiring Diagram (Standard Instrument Panel For North America)

S1 KEY SWITCH					
	B	G	ACC.	ON	ST.
OFF					
ACC.	•		•		
ON	•		•	•	
START	•	•		•	•

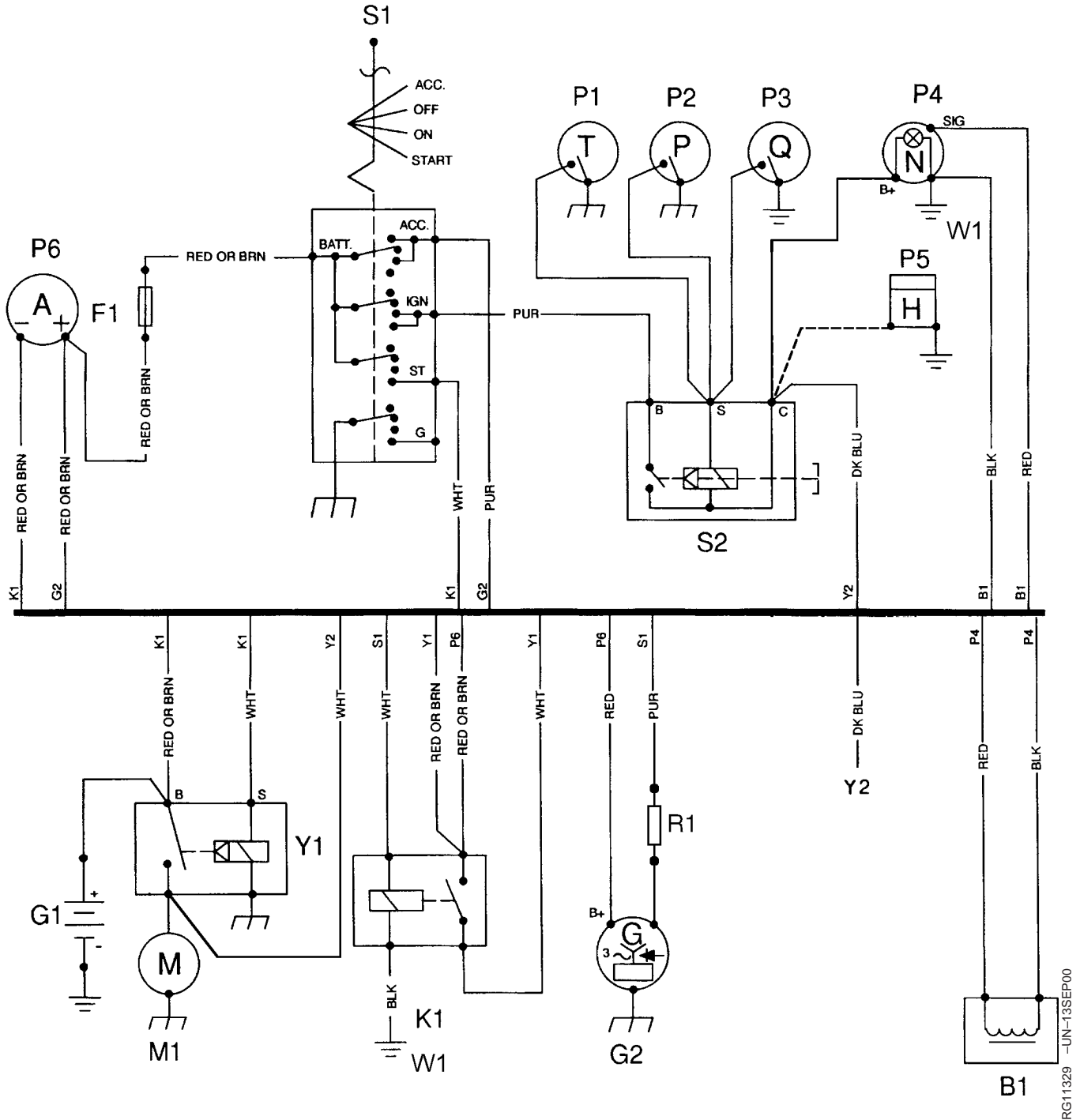

RG11329 -UN-13SEP00

DPSG, RG41165, 127 -19-19JUN00-1/1

### Engine Wiring Diagram—VDO Instrument Panel (Except North America)

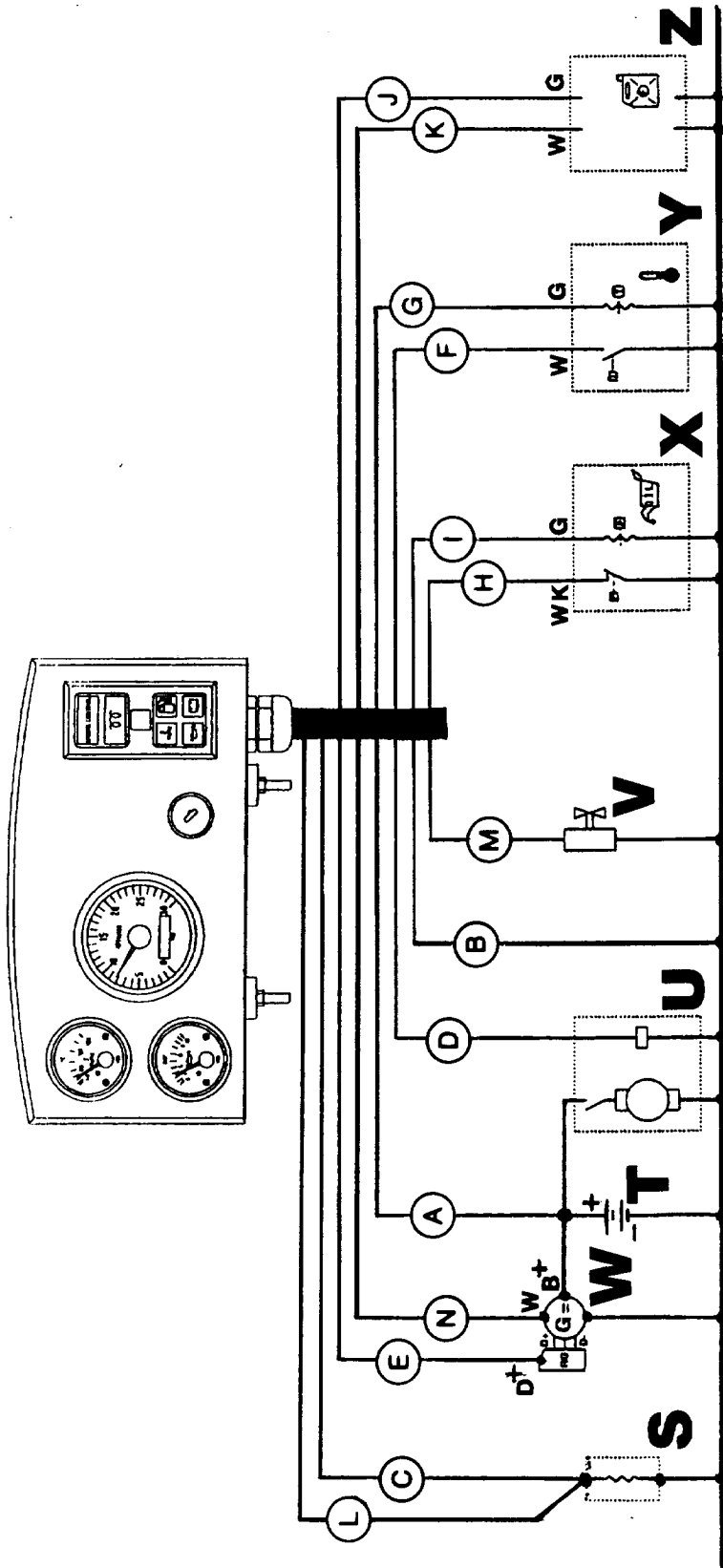

DPSG, RG41165, 131 -19-13NOV/98  
CD623P5 -UN-13NOV/98

## Engine Wiring Diagram Legend—VDO Instrument Panel (Except North America)

<b>A</b> — 6 mm <sup>2</sup> , Red	<b>M</b> — 0.75 mm <sup>2</sup> , Green/Yellow
<b>B</b> — 1.5 mm <sup>2</sup> , Black	<b>N</b> — 0.75 mm <sup>2</sup> , Red
<b>C</b> — 6 mm <sup>2</sup> , Blue	<b>O—R</b> — Not Used
<b>D</b> — 4 mm <sup>2</sup> , Black	<b>S</b> — Preheater
<b>E</b> — 0.75 mm <sup>2</sup> , Orange	<b>T</b> — Battery
<b>F</b> — 0.75 mm <sup>2</sup> , White	<b>U</b> — Starter Motor
<b>G</b> — 0.75 mm <sup>2</sup> , Blue	<b>V</b> — Electrical Shut-Off
<b>H</b> — 0.75 mm <sup>2</sup> , Purple	<b>W</b> — Alternator
<b>I</b> — 0.75 mm <sup>2</sup> , Grey	<b>X</b> — Oil Pressure Sensor
<b>J</b> — 0.75 mm <sup>2</sup> , Brown	<b>Y</b> — Coolant Temperature Sensor
<b>K</b> — 0.75 mm <sup>2</sup> , Dark Blue	<b>Z</b> — Fuel Tank Gauge
<b>L</b> — 0.75 mm <sup>2</sup> , Black	

DPSG, RG41165, 129 -19-19JUN00-1/1

## Engine Troubleshooting

Symptom	Problem	Solution
<b>Engine cranks but will not start</b>	Incorrect starting procedure.	Verify correct starting procedure.
	No fuel.	Check fuel in tank and manual shut-off valve.
	Exhaust restricted.	Check and correct exhaust restriction.
	Fuel filter plugged or full of water.	Replace fuel filter or drain water from filter.
	Injection pump not getting fuel or air in fuel system.	Check fuel flow at supply pump or bleed fuel system.
	Faulty injection pump or nozzles.	Consult authorized diesel repair station for repair or replacement.
<b>Engine hard to start or will not start</b>	Engine starting under load.	Disengage driveline.
	Improper starting procedure.	Review starting procedure.
	No fuel.	Check fuel tank.
	Air in fuel line.	Bleed fuel line.
	Cold weather.	Use cold weather starting aids.
	Slow starter speed.	See "Starter Cranks Slowly".
	Crankcase oil too heavy.	Use oil of proper viscosity.
	Improper type of fuel.	Consult fuel supplier; use proper type fuel for operating conditions.
	Water, dirt, or air in fuel system.	Drain, flush, fill, and bleed system.
	Clogged fuel filter.	Replace filter element.
	Dirty or faulty injection nozzles.	Have authorized servicing dealer or engine distributor check injectors.
	Injection pump shut-off not reset.	Turn key switch to "OFF" then to "ON".

Continued on next page

OUOD006.000004C -19-13OCT06-1/7

<b>Symptom</b>	<b>Problem</b>	<b>Solution</b>
<b>Engine knocks</b>	Low engine oil level.	Add oil to engine crankcase.
	Injection pump out of time.	See your authorized servicing dealer or engine distributor.
	Low coolant temperature.	Remove and check thermostat.
	Engine overheating.	See "Engine Overheats".
<b>Engine runs irregularly or stalls frequently</b>	Low coolant temperature.	Remove and check thermostat.
	Clogged fuel filter.	Replace fuel filter element.
	Water, dirt, or air in fuel system.	Drain, flush, fill, and bleed system.
	Poor quality fuel.	Change to better quality fuel.
	Dirty or faulty injection nozzles.	Have authorized servicing dealer or engine distributor check injectors.
<b>Below normal engine temperature</b>	Defective thermostat.	Remove and check thermostat.
	Defective temperature gauge or sender.	Check gauge, sender, and connections.

Continued on next page

OUOD006,000004C -19-13OCT06-2/7

<b>Symptom</b>	<b>Problem</b>	<b>Solution</b>
<b>Lack of power</b>	Engine overloaded.	Reduce load.
	Intake air restriction.	Service air cleaner.
	Clogged fuel filter.	Replace filter elements.
	Improper type of fuel.	Use proper fuel.
	Overheated engine.	See "Engine Overheats".
	Below normal engine temperature.	Remove and check thermostat.
	Improper valve clearance.	See your authorized servicing dealer or engine distributor.
	Dirty or faulty injection nozzles.	Have authorized servicing dealer or engine distributor check injectors.
	Injection pump out of time.	See your authorized servicing dealer or engine distributor.
	Turbocharger not functioning. (Turbocharger engines only.)	See your authorized servicing dealer or engine distributor.
	Leaking exhaust manifold gasket.	See your authorized servicing dealer or engine distributor.
	Defective aneroid control line.	See your authorized servicing dealer or engine distributor.
	Restricted fuel hose.	Clean or replace fuel hose.
<b>Low oil pressure</b>	Low fast idle speed.	See your authorized servicing dealer or engine distributor.
	Low oil level.	Add oil.
	Improper type of oil.	Drain, fill crankcase with oil of proper viscosity and quality.

Continued on next page

OUOD006,000004C -19-13OCT06-3/7



<b>Symptom</b>	<b>Problem</b>	<b>Solution</b>
<b>High oil consumption</b>	Crankcase oil too light.	Use proper viscosity oil.
	Oil leaks.	Check for leaks in lines, gaskets, and drain plug.
	Restricted crankcase vent tube.	Clean vent tube.
	Defective turbocharger.	See your authorized servicing dealer or engine distributor.
<b>Engine emits white smoke</b>	Improper type of fuel.	Use proper fuel.
	Low engine temperature.	Warm up engine to normal operating temperature.
	Defective thermostat.	Remove and check thermostat.
	Defective injection nozzles.	See your authorized servicing dealer or engine distributor.
	Engine out of time.	See your authorized servicing dealer or engine distributor.
<b>Engine emits black or gray exhaust smoke</b>	Improper type of fuel.	Use proper fuel.
	Clogged or dirty air cleaner.	Service air cleaner.
	Engine overloaded.	Reduce load.
	Injection nozzles dirty.	See your authorized servicing dealer or engine distributor.
	Engine out of time.	See your authorized servicing dealer or engine distributor.
	Turbocharger not functioning.	See your authorized servicing dealer or engine distributor.

Continued on next page

OUOD006,000004C -19-13OCT06-4/7

<b>Symptom</b>	<b>Problem</b>	<b>Solution</b>
<b>Engine overheats</b>	Engine overloaded.	Reduce load.
	Low coolant level.	Fill radiator to proper level, check radiator and hoses for loose connections or leaks.
	Faulty radiator cap.	Have serviceman check.
	Stretched poly-vee belt or defective belt tensioner.	Check automatic belt tensioner and check belts for stretching. Replace as required.
	Low engine oil level.	Check oil level. Add oil as required.
	Cooling system needs flushing.	Flush cooling system.
	Defective thermostat.	Remove and check thermostat.
	Defective temperature gauge or sender.	Check water temperature with thermometer and replace, if necessary.
	Incorrect grade of fuel.	Use correct grade of fuel.
	<b>High fuel consumption</b>	Improper type of fuel.
Clogged or dirty air cleaner.		Service air cleaner.
Engine overloaded.		Reduce load.
Improper valve clearance.		See your authorized servicing dealer or engine distributor.
Injection nozzles dirty.		See your authorized servicing dealer or engine distributor.
Engine out of time.		See your authorized servicing dealer or engine distributor.
Defective turbocharger.		See your authorized servicing dealer or engine distributor.
Low engine temperature.		Check thermostat.

Continued on next page

QUOD006.000004C -19-13OCT06-5/7

<b>Symptom</b>	<b>Problem</b>	<b>Solution</b>
<b>Undercharged electrical system</b>	Excessive electrical load from added accessories.	Remove accessories or install higher output alternator.
	Excessive engine idling.	Increase engine rpm when heavy electrical load is used.
	Poor electrical connections on battery, ground strap, starter, or alternator.	Inspect and clean as necessary.
	Defective battery.	Test battery.
	Defective alternator.	Test charging system.
<b>Battery uses too much water</b>	Cracked battery case.	Check for moisture and replace as necessary.
	Defective battery.	Test battery.
	Battery charging rate too high.	Test charging system.
<b>Batteries will not charge</b>	Loose or corroded connections.	Clean and tighten connections.
	Sulfated or worn-out batteries.	See your authorized servicing dealer or engine distributor.
	Stretched poly-vee belt or defective belt tensioner.	Adjust belt tension or replace belts.
<b>Starter will not crank</b>	Engine driveline engaged.	Disengage engine driveline.
	Loose or corroded connections.	Clean and tighten loose connections.
	Low battery output voltage.	See your authorized servicing dealer or engine distributor.
	Faulty start circuit relay.	See your authorized servicing dealer or engine distributor.
	Blown main system fuse (MDL-25)	Replace fuse.
<b>Starter cranks slowly</b>	Low battery output.	See your authorized servicing dealer or engine distributor.
	Crankcase oil too heavy.	Use proper viscosity oil.
	Loose or corroded connections.	Clean and tighten loose connections.

Continued on next page

QUOD006.000004C -19-13OCT06-6/7

## Troubleshooting

Symptom	Problem	Solution
<b>Starter and hour meter functions; rest of electrical system does not function</b>	Blown fuse on magnetic switch.	Replace fuse.
<b>Entire electrical system does not function</b>	Faulty battery connection.	Clean and tighten connections.
	Sulfated or worn-out batteries.	See your authorized servicing dealer or engine distributor.
	Blown main system fuse (MDL-25).	Replace fuse.

OUOD006,000004C -19-13OCT06-7/7

# Storage

## Engine Storage Guidelines

1. John Deere engines can be stored outside for up to three (3) months with no long term preparation IF COVERED BY WATERPROOF COVERING. No outside storage is recommended without a waterproof covering.
2. John Deere engines can be stored in a standard overseas shipping container for up to three (3) months with no long term preparation.
3. John Deere engines can be stored inside for up to six (6) months with no long term preparation.
4. John Deere engines expected to be stored more than six (6) months MUST have long term storage preparation. ( See PREPARING ENGINE FOR LONG TERM STORAGE, later in this section.)
5. Long term storage includes the use of a stabilized rust preventive oil to protect internal metal components of the engine. This oil should be an SAE 10 oil with 1-4 percent morpholine or equivalent vapor corrosion inhibitor. These rust preventive oils are available from area distributors.

OURGP12,00000DF -19-11OCT06-1/1

## Preparing Engine for Long Term Storage

The following storage preparations are used for long term engine storage up to one year. After that, the engine should be started, warmed up, and retreated for an extended storage period.

**IMPORTANT: Any time your engine will not be used for over six (6) months, the following recommendations for storing it and removing it from storage will help to minimize corrosion and deterioration.**

1. Change engine oil and replace filter. (See CHANGE ENGINE OIL AND FILTER in Lubrication and Maintenance/500 Hour Section.) Used oil will not give adequate protection. Add one (1) ounce of rust preventive oil to the engine crankcase for every quart of oil. This rust preventive oil should be an SAE 10 oil with 1-4 percent morpholine or equivalent vapor corrosion inhibitor.
  2. Service air cleaner. (See REPLACING AIR CLEANER FILTER ELEMENTS in Service As Required Section.)
  3. Draining and flushing of cooling system is not necessary if engine is to be stored only for several months. However, for extended storage periods of a year or longer, it is recommended that the cooling system be drained, flushed, and refilled. Refill with appropriate coolant. (See RECOMMENDED ENGINE COOLANT in Fuels, Lubricants, and Coolant Section and ADDING COOLANT in Service As Required Section.)
  4. Pour three (3) ounces of rust preventive oil into the turbocharger intake. (It may be necessary to temporarily install a short intake elbow on the turbocharger inlet to receive the oil.)
  5. Prepare a tank with a solution of diesel fuel and rust preventive oil, at ten (10) ounces of rust preventive oil per gallon of diesel fuel.
  6. Remove existing lines/plugs as required, and run a temporary line from the tank to the engine fuel intake, and another temporary line from the fuel return manifold to the tank, so rust preventive oil solution is circulated through the injection system during cranking.
  7. Crank the engine several revolutions with starter (do not allow the engine to start). This will allow rust preventive oil solution to circulate.
  8. Remove temporary lines installed in Step 6 above, and replace any lines/plugs previously removed.
- NOTE: One gallon of fuel/oil solution can be used to treat 100 engines; two gallons to treat 200 engines, etc. The oil could then be replenished by adding an additional five (5) ounces of rust preventive oil per gallon of solution. However, starting over with a new solution is recommended to dispose of any water or other impurities.*
9. Loosen, or remove and store, fan/alternator poly-vee belt.
  10. Remove and clean batteries. Store them in a cool, dry place and keep them fully charged.
  11. Disengage the clutch for any driveline.
  12. Clean the exterior of the engine with salt-free water and touch up any scratched or chipped painted surfaces with a good quality paint.
  13. Coat all exposed (machined) metal surfaces with grease or corrosion inhibitor if not feasible to paint.
  14. Seal all openings on engine with plastic bags and tape.

Continued on next page

OURGP11,000006C -19-27JUL06-1/2

15. Store the engine in a dry protected place. If engine must be stored outside, cover it with a

waterproof canvas or other suitable protective material and use a strong waterproof tape.

OURGP11,000006C -19-27JUL06-2/2

## Removing Engine from Long Term Storage

Refer to the appropriate section for detailed services listed below or have your authorized servicing dealer or engine distributor perform services that you may not be familiar with.

1. Remove all protective coverings from engine. Unseal all openings in engine and remove covering from electrical systems.
2. Remove the batteries from storage. Install batteries (fully charged) and connect the terminals.
3. Install fan/alternator poly-vee belt if removed.
4. Fill fuel tank.
5. Perform all appropriate prestarting checks. ( See DAILY PRESTARTING CHECKS in Lubrication and Maintenance/Daily Section.)

**IMPORTANT: DO NOT operate starter more than 30 seconds at a time. Wait at least 2 minutes for starter to cool before trying again.**

6. Crank engine for 20 seconds with starter (do not allow the engine to start). Wait 2 minutes and crank engine an additional 20 seconds to assure bearing surfaces are adequately lubricated.
7. Start engine and run at low idle and no load for several minutes. Warm up carefully and check all gauges before placing engine under load.
8. On the first day of operation after storage, check overall engine for leaks and check all gauges for correct operation.

RG, RG34710, 5613 -19-11OCT06-1/1

# Specifications

## General OEM Engine Specifications—4.5 L Engines

ITEM	ENGINE							
	4045DF120	4045DF150	4045TF120	4045TF150	4045TF220	4045TF250	4045HF120	4045HF150
Number of Cylinders	4	4	4	4	4	4	4	4
Bore	106 mm (4.19 in.)	106 mm (4.19 in.)	106 mm (4.19 in.)	106 mm (4.19 in.)	106 mm (4.19 in.)	106 mm (4.19 in.)	106 mm (4.19 in.)	106 mm (4.19 in.)
Stroke	127 mm (5.0 in.)	127 mm (5.0 in.)	127 mm (5.0 in.)	127 mm (5.0 in.)	127 mm (5.0 in.)	127 mm (5.0 in.)	127 mm (5.0 in.)	127 mm (5.0 in.)
Displacement	4.5 L (276 cu in.)	4.5 L (276 cu in.)	4.5 L (276 cu in.)	4.5 L (276 cu in.)	4.5 L (276 cu in.)	4.5 L (276 cu in.)	4.5 L (276 cu in.)	4.5 L (276 cu in.)
Compression Ratio	17.8:1	17.6:1	17.0:1	17.0:1	17.0:1	17.0:1	17.0:1	17.0:1
Max. Crank Pressure	0.5 kPa (2 H <sub>2</sub> O)	0.5 kPa (2 H <sub>2</sub> O)	0.5 kPa (2 H <sub>2</sub> O)	0.5 kPa (2 H <sub>2</sub> O)	0.5 kPa (2 H <sub>2</sub> O)	0.5 kPa (2 H <sub>2</sub> O)	0.5 kPa (2 H <sub>2</sub> O)	0.5 kPa (2 H <sub>2</sub> O)
Governor Regulation (Industrial)	7—10 %	7—10 %	N/A	7—10 %	N/A	7—10 %	N/A	7—10 %
Governor Regulation (Generator)	N/A	5 %	5%	5 %	5%	5 %	5%	5 %
Oil Pressure, Rated Speed, Full Load (±15 psi)	345 kPa (50 psi)	345 kPa (50 psi)	345 kPa (50 psi)	345 kPa (50 psi)	345 kPa (50 psi)	345 kPa (50 psi)	345 kPa (50 psi)	345 kPa (50 psi)
Oil Pressure, Low Idle (Minimum)	105 kPa (15 psi)	105 kPa (15 psi)	105 kPa (15 psi)	105 kPa (15 psi)	105 kPa (15 psi)	105 kPa (15 psi)	105 kPa (15 psi)	105 kPa (15 psi)
Length	844.0 mm (33.2 in.)	861.0 mm (33.9 in.)	861.0 mm (33.9 in.)	861.0 mm (33.9 in.)	861.0 mm (33.9 in.)	861.0 mm (33.9 in.)	861.0 mm (33.9 in.)	861.0 mm (33.9 in.)
Width	550 mm (21.7 in.)	598 mm (23.5 in.)	598 mm (23.5 in.)	598 mm (23.5 in.)	598 mm (23.5 in.)	598 mm (23.5 in.)	598 mm (23.5 in.)	598 mm (23.5 in.)
Height	871 mm (34.3 in.)	854 mm (33.6 in.)	980 mm (38.6 in.)	980 mm (38.6 in.)	980 mm (38.6 in.)	980 mm (38.6 in.)	980 mm (38.6 in.)	980 mm (38.6 in.)
Weight	429 kg (945 lb)	387 kg (851 lb)	396 kg (872 lb)	396 kg (872 lb)	396 kg (872 lb)	396 kg (872 lb)	396 kg (872 lb)	396 kg (872 lb)

*NOTE: Engine models listed with numbers ending in "120" and "220" are emission non-certified. Engines with model numbers ending in "150" and "250" are Tier 1 emission certified. (Later engines with model numbers ending in "270", "275" or "475" are Tier 2 emission certified with mechanical or electronic fuel systems and are covered in another manual, OMRG33324.)*

OURGP12,0000041 -19-18OCT06-1/1



## General OEM Engine Specifications—6.8 L Engines

ITEM	ENGINE							
	6068DF150	6068TF120	6068TF150	6068TF220	6068TF250	6068HF120	6068HF150	6068HF250
Number of Cylinders	6	6	6	6	6	6	6	6
Bore	106 mm (4.19 in.)	106 mm (4.19 in.)	106 mm (4.19 in.)	106 mm (4.19 in.)	106 mm (4.19 in.)	106 mm (4.19 in.)	106 mm (4.19 in.)	106 mm (4.19 in.)
Stroke	127 mm (5.0 in.)	127 mm (5.0 in.)	127 mm (5.0 in.)	127 mm (5.0 in.)	127 mm (5.0 in.)	127 mm (5.0 in.)	127 mm (5.0 in.)	127 mm (5.0 in.)
Displacement	6.8 L (414 cu in.)	6.8 L (414 cu in.)	6.8 L (414 cu in.)	6.8 L (414 cu in.)	6.8 L (414 cu in.)	6.8 L (414 cu in.)	6.8 L (414 cu in.)	6.8 L (414 cu in.)
Compression	17.6:1	17.0:1	17.0:1	17.0:1	17.0:1	17.0:1	17.0:1	17.0:1
Max. Crank Pressure	0.5 kPa (2 H <sub>2</sub> O)	0.5 kPa (2 H <sub>2</sub> O)	0.5 kPa (2 H <sub>2</sub> O)	0.5 kPa (2 H <sub>2</sub> O)	0.5 kPa (2 H <sub>2</sub> O)	0.5 kPa (2 H <sub>2</sub> O)	0.5 kPa (2 H <sub>2</sub> O)	0.5 kPa (2 H <sub>2</sub> O)
Governor Regulation (Industrial)	7—10 %	N/A	7—10 %	7—10 %	7—10 %	N/A	7—10 %	7—10 %
Governor Regulation (Generator)	5 %	5%	5 %	5%	5 %	5 %	5 %	5%
Oil Pressure At Rated Speed, Full Load (±15 psi)	345 kPa (50 psi)	345 kPa (50 psi)	345 kPa (50 psi)	345 kPa (50 psi)	345 kPa (50 psi)	345 kPa (50 psi)	345 kPa (50 psi)	345 kPa (50 psi)
Oil Pressure At Low Idle (Minimum)	105 kPa (15 psi)	105 kPa (15 psi)	105 kPa (15 psi)	105 kPa (15 psi)	105 kPa (15 psi)	105 kPa (15 psi)	105 kPa (15 psi)	105 kPa (15 psi)
Length	1117 mm (44.0 in.)	1117 mm (44.0 in.)	1117 mm (44.0 in.)	1116 mm (43.9 in.)	1117 mm (44.0 in.)	1141 mm (44.9 in.)	1116 mm (43.9 in.)	1141 mm (44.9 in.)
Width	598 mm (23.5 in.)	598 mm (23.5 in.)	598 mm (23.5 in.)	623 mm (24.5 in.)	598 mm (23.5 in.)	623 mm (24.5 in.)	623 mm (24.5 in.)	623 mm (24.5 in.)
Height	956 mm (37.6 in.)	984 mm (38.7 in.)	984 mm (38.7 in.)	1012 mm (39.9 in.)	984 mm (38.7 in.)	1009 mm (39.7 in.)	1009 mm (39.7 in.)	1009 mm (39.7 in.)
Weight	522 kg (1149 lb)	533 kg (1172 lb)	533 kg (1172 lb)	551 kg (1212 lb)	533 kg (1172 lb)	568 kg (1250 lb)	550 kg (1210 lb)	568 kg (1250 lb)

*NOTE: Engine models listed with numbers ending in "120" and "220" are emission non-certified. Engines with model numbers ending in "150" and "250" are Tier 1 emission certified. (Later engines with model numbers ending in "270", "275" or "475" are Tier 2 emission certified with mechanical or electronic fuel systems and are covered in another manual, OMRG33324.)*

## Engine Power Ratings And Fuel Injection Pump Specifications

**NOTE:** The power specifications shown below apply to Dubuque, Torreon and Saran-built OEM engines. Specifications are subject to change. Refer to factory DTAC for assistance.

machine technical manual for engine speeds that are different from those preset at the factory.

Engine speeds listed are as preset to factory specification. In most cases, slow idle speed will be reset depending upon specific vehicle application requirements. Refer to your

Power ratings specify flywheel power for a bare engine without the drag effect of a cooling fan or other accessories like an air compressor.

**POWER RATINGS ON DYNAMOMETER FOR OEM ENGINES**

Engine Model	Injection Pump Option Code	Original Injection Pump (Part No.)	Replaced By Injection Pump (Part No.)	Governor Regulation	Rated Speed (rpm) At Full Load	Slow Idle (rpm)	No Load Fast Idle (rpm)	Power Rating kW (HP)
4045DF120	16MR	RE504463		STD	2500	850	2700	63 (85)
	16MS	RE504464		STD	2500	850	2700	63 (85)
	165F	RE503729		3—5%	1500	—	1560	44 (59)
	165G	RE504693		3—5%	1500	—	1560	44 (59)
	16RB	RE503729		3—5%	1500	—	1560	44 (59)
	16RC	RE504693		3—5%	1500	—	1560	44 (59)
	16ZW	RE509527		3—5%	2500	850	2700	63 (85)
	16ZX	RE509528		3—5%	2500	850	2700	63 (85)
	16ZY	RE509529		3—5%	2500	850	2700	63 (85)
4045DF150	1601	RE61649	RE67557	STD	2500	850	2700	60 (80)
	1601	RE67557		STD	2500	850	2700	60 (80)
	1602	RE59809		STD	2500	850	2700	63 (85)
	1603	RE63555	RE67558	3—5%	1800	1150	1870	53 (71)
	1603	RE67558	RE505070	3—5%	1800	1150	1870	53 (71)
	1603	RE505070	RE506132	3—5%	1800	1150	1870	53 (71)
	1603	RE506132		3—5%	1800	1150	1870	53 (71)
	1663	RE71089	RE500949	STD	2500	1600	2700	60 (80)
	1663	RE500949		STD	2500	1600	2700	60 (80)
	1671	RE67559	RE502714	STD	2500	850	2700	60 (80)
	1671	RE502714		STD	2500	850	2700	60 (80)
	1673	RE60085	RE67560	3—5%	1800	1400	1870	53 (71)
	1673	RE67560	RE506130	3—5%	1800	1400	1870	53 (71)
	1673	RE506130		3—5%	1800	1400	1870	53 (71)
	1674	RE60089	RE67561	3—5%	1800	1400	1870	53 (71)
	1674	RE67561	RE506131	3—5%	1800	1400	1870	53 (71)
	1674	RE506131		3—5%	1800	1400	1870	53 (71)
1691	RE61649	RE500831	STD	2500	850	2700	60 (80)	
1691	RE500831	RE500948	STD	2500	850	2700	60 (80)	
1691	RE500948		STD	2500	850	2700	60 (80)	
16BG	RE69778	RE502712	STD	2500	850	2700	63 (85)	
16BG	RE502712		STD	2500	850	2700	63 (85)	

Continued on next page

OURGP11.000001D -19-13OCT06-1/9

Specifications

POWER RATINGS ON DYNAMOMETER FOR OEM ENGINES

Engine Model	Injection Pump Option Code	Original Injection Pump (Part No.)	Replaced By Injection Pump (Part No.)	Governor Regulation	Rated Speed (rpm) At Full Load	Slow Idle (rpm)	No Load Fast Idle (rpm)	Power Rating kW (HP)
	16BH	RE500873	RE502715	STD	2500	850	2700	63 (85)
	16BH	RE502715		STD	2500	850	2700	63 (85)
	16BJ	RE500589		STD	2250	850	2450	36 (48)
	16CL	RE501364	RE502713	STD	2200	950	2400	58 (78)
	16CL	RE502713		STD	2200	950	2400	58 (78)
	16DL	RE70452		STD	2400	850	2600	61 (82)
	16EN	RE502019		STD	2500	850	2700	60 (80)
	16GB	RE502711		STD	2500	850	2700	60 (80)
	16GC	RE502716		STD	2500	850	2700	60 (80)
	16HJ	RE500948		STD	2500	1400	2700	60 (80)
	16HK	RE500949		STD	2500	1600	2700	60 (80)
	16HV	RE503258		STD	2250	850	2450	36 (48)
	16KE	RE503560		STD	2500	850	2700	52 (70)
	16LM	RE502711		STD	2500	850	2700	53 (71)
	16LN	RE67558	RE505070	3—5%	1800	1150	1870	53 (71)
	16LN	RE505070	RE506132	3—5%	1800	1150	1870	53 (71)
	16LN	RE506132		3—5%	1800	1150	1870	53 (71)
	16RB	RE503729		3—5%	1500	1400	1560	44 (59)
	16RC	RE504693		3—5%	1500	1400	1560	44 (59)
	165W	RE500949		STD	2500	1600	2700	60 (80)
4045DF151	1663	RE71089	RE500949	STD	2500	1600	2700	60 (80)
	1663	RE500949		STD	2500	1600	2700	60 (80)
4045DF152	1601	RE67557		STD	2500	850	2700	60 (80)
	16GB	RE502711		STD	2500	850	2700	60 (80)
4045DF154	16AY	RE500505		STD	2400	850	2600	62 (83)
	16JS	RE500505		STD	2400	850	2600	62 (83)
4045HF120	16GR	RE503050	RE506965	3—5%	1500	1400	1560	102 (137)
	16LW	RE503832	RE506966	3—5%	1500	1400	1560	102 (137)
4045HF150	1610	RE68826	RE505928	STD	2400	850	2600	104 (140)
	1611	RE60237		3—5%	1800	1400	1870	95 (127)
	160B	RE68827		3—5%	1800	1400	1870	95 (127)
	160C	RE69588	RE505959	STD	2400	850	2600	104 (140)
	16GR	RE503050		3—5%	1500	1150	1560	100 (134)
	16LW	RE503832		3—5%	1500	1150	1560	100 (134)
	16ME	RE503739		3—5%	1800	—	1870	120 (161)
	16MF	RE504966		3—5%	1800	—	1870	123 (164)
	16QZ	RE503050		3—5%	1800	1400	1870	111 (149)
	16RA	RE503832		3—5%	1800	1400	1870	111 (149)
4045HF152	16RM	RE505959		STD	2400	850	2600	104 (140)
4045HF157	16GR	RE503050			1500	—	1560	102 (137)
	16LW	RE503832			1500	—	1560	102 (137)

Continued on next page

OURGP11.000001D -19-13OCT06-2/9

Specifications

**POWER RATINGS ON DYNAMOMETER FOR OEM ENGINES**

Engine Model	Injection Pump Option Code	Original Injection Pump (Part No.)	Replaced By Injection Pump (Part No.)	Governor Regulation	Rated Speed (rpm) At Full Load	Slow Idle (rpm)	No Load Fast Idle (rpm)	Power Rating kW (HP)
4045HF158	16GR	RE503050		3—5%	1500	1150	1560	100 (134)
	16LW	RE503832		3—5%	1500	1150	1560	100 (134)
	16ME	RE503739		3—5%	1800	1400	1870	123 (165)
	16MF	RE504698	RE504966	3—5%	1800	1400	1870	123 (170)
	16MF	RE504966		3—5%	1800	1400	1870	123 (170)
4045HF252		RE522414		3—5%	3000	850	3120	125 (168)
		RE522698		3—5%	3000	850	3120	125 (168)
	169E	RE522414		3—5%	3000	850	3120	152 (204)
	169F	RE522698		3—5%	3000	850	3120	152 (204)
4045TF120	16MT	RE503733	RE505989	3—5%	1500	1400	1560	70 (94)
	16MT	RE506989		3—5%	1500	1400	1560	70 (94)
	16MU	RE505050	RE506990	3—5%	1500	1400	1560	70 (94)
	16MU	RE506990		3—5%	1500	1400	1560	70 (94)
	16ZW	RE509527		3—5%	1500	1400	1560	70 (94)
	16ZX	RE509528		3—5%	1500	1400	1560	70 (94)
	16ZY	RE509529		3—5%	1500	1400	1560	70 (94)
	165D	RE506989		3—5%	1500	—	1560	70 (94)
	165E	RE506990		3—5%	1500	—	1560	70 (94)
	4045TF150	1605	RE61668	RE69781	STD	2500	850	2700
1605		RE69781		STD	2500	850	2700	86 (115)
1606		RE64133	RE505927	STD	2400	850	2600	93 (125)
1606		RE505927		STD	2400	850	2600	93 (125)
1656		RE63610	RE67562	3—5%	1800	1150	1870	75 (100)
1656		RE67562		3—5%	1800	1150	1870	75 (100)
1675		RE60091	RE69782	STD	2500	850	2700	86 (115)
1675		RE69782		STD	2500	850	2700	86 (115)
1676		RE60093	RE61668	STD	2500	850	2700	86 (115)
1676			RE61668	STD	2500	850	2700	86 (115)
1677		RE60096	RE67563	3—5%	1800	1150	1870	75 (100)
1677		RE67563		3—5%	1800	1150	1870	75 (100)
1692		RE61668	RE500881	STD	2500	1400	2700	86 (115)
1692		RE500881	RE502416	STD	2500	1400	2700	86 (115)
1692		RE502416		STD	2500	1400	2700	86 (115)
1694		RE67863	RE69779	STD	2500	850	2700	75 (100)
1694		RE69779		STD	2500	850	2700	75 (100)
1695	RE69739	RE69780	STD	2500	850	2700	75 (100)	
1695	RE69780		STD	2500	850	2700	75 (100)	
16AB	RE69779		STD	2500	850	2700	75 (100)	
16BF	RE500848		STD	2200	950	2400	73 (98)	
16CE	RE501180		STD	2500	850	2700	75 (100)	
16CM	RE501365		STD	2200	950	2400	66.6 (89)	
16GL	RE502706		STD	2300	850	2500	78 (105)	

Continued on next page

OURGP11.000001D -19-13OCT06-3/9

Specifications

**POWER RATINGS ON DYNAMOMETER FOR OEM ENGINES**

Engine Model	Injection Pump Option Code	Original Injection Pump (Part No.)	Replaced By Injection Pump (Part No.)	Governor Regulation	Rated Speed (rpm) At Full Load	Slow Idle (rpm)	No Load Fast Idle (rpm)	Power Rating kW (HP)
	16LP	RE67562		3—5%	1800	1150	1870	75 (100)
	16LZ	RE503735		3—5%	1800	1400	1870*	70 (94)
	16MA	RE504696	RE504931	3—5%	1800	1400	1870	82 (110)
	16MA	RE504931		3—5%	1800	1400	1870	82 (110)
	16MT	RE503733	RE505050	3—5%	1500	1400	1560	70 (94)
	16MT	RE505050		3—5%	1500	1400	1560	70 (94)
	16MU	RE504695	RE505050	3—5%	1500	1400	1560	70 (94)
	16MU	RE505050	RE506990	3—5%	1500	1400	1560	70 (94)
	16MU	RE506990		3—5%	1500	1400	1560	70 (94)
	16TG	RE507941		STD	2000	850	2185	77 (103)
	16YJ	RE508834		STD	2000	850	2185	77 (103)
	16YU	RE508754		3—5%	1800	—	1870	75 (101)
	16ZC	RE518780		STD	2200	950	2400	66 (89)
4045TF151	1677	RE60096	RE67563	3—5%	1800	850	1870	75 (100)
	1677	RE67563		3—5%	1800	850	1870	75 (100)
	16CU	RE501192		STD	2200	850	2400	79.5 (107)
	16NH	RE505411		3—5%	1800	1150	2240	75 (100)
4045TF152	16AX	RE500551		STD	2400	850	2600	76 (102)
4045TF154	1605	RE69781		STD	2500	850	2700	86 (115)
4045TF155	16AX	RE500551		STD	2400	850	2600	76 (102)
	16JT	RE500551		STD	2400	850	2600	76 (102)
4045TF157	16GQ	RE503048		3—5%	1500	—	1560	83 (111)
	16LV	RE503830		3—5%	1500	—	1560	83 (111)
4045TF158	16GQ	RE503048		3—5%	1500	—	1560	83 (111)
	16LZ	RE503735		3—5%	1800	—	1870	82 (110)
	16MA	RE504696		3—5%	1800	—	1870	82 (110)
	16MT	RE503733	RE506989	3—5%	1500	—	1560	70 (94)
	16MT	RE506989		3—5%	1500	—	1560	70 (94)
	16MU	RE504695	RE505050	3—5%	1500	—	1560	70 (94)
	16MU	RE505050	RE506990	3—5%	1500	—	1560	70 (94)
	16MU	RE506990		3—5%	1500	—	1560	70 (94)
4045TF161	16PZ	RE500848		STD	2200	850	2400	73 (98)
4045TF162	16GL	RE502706		STD	2300	850	2500	78 (104)
4045TF220	16GQ	RE503048	RE506544	3—5%	1500	1400	1560	83 (111)
	16GQ	RE506544		3—5%	1500	1400	1560	83 (111)
	16LV	RE503830	RE506545	3—5%	1500	1400	1560	83 (111)
	16LV	RE506545		3—5%	1500	1400	1560	83 (111)
	16MT	RE503733		3—5%	1500	1400	1560	70 (94)
	16MV	RE503736		3—5%	1800	1400	1870	100 (134)
	16MW	RE504682		3—5%	1800	1400	1870	100 (134)
	16NT	RE504465		STD	2500	850	2700	86 (115)

Continued on next page

OURGP11.000001D -19-13OCT06-4/9

Specifications

POWER RATINGS ON DYNAMOMETER FOR OEM ENGINES

Engine Model	Injection Pump Option Code	Original Injection Pump (Part No.)	Replaced By Injection Pump (Part No.)	Governor Regulation	Rated Speed (rpm) At Full Load	Slow Idle (rpm)	No Load Fast Idle (rpm)	Power Rating kW (HP)
	16NU	RE504466		STD	2500	850	2700	86 (115)
	16ZZ	RE508613		STD	2100	850	2200	107 (143)
	161A	RE509525		STD	2100	850	2200	107 (143)
	161B	RE509526		STD	2100	850	2200	107 (143)
	168Q	RE521143		3—5%	1500	—	1560	83 (111)
	168R	RE522388		3—5%	1500	—	1560	83 (111)
4045TF250	1606	RE64133	RE505927	STD	2400	850	2600	93 (125)
	1606	RE505927		STD	2400	850	2600	93 (125)
	1608	RE67564		3—5%	1800	1400	1870	84 (113)
	1667	RE59968		STD	2400	850	2600	93 (125)
	1682	RE67566		3—5%	1800	1400	1870	84 (113)
	1683	RE60124	RE505926	STD	2400	850	2600	93 (125)
	1683	RE505926		STD	2400	850	2600	93 (125)
	160R	RE70941		3—5%	1800	1400	1870	84 (113)
	16CV	RE501346		STD	2200	950	2400	85 (114)
	16GQ	RE503048		3—5%	1500	1150	1560	83 (111)
	16LQ	RE67564		3—5%	1800	1400	1870	84 (113)
	16LV	RE503830		3—5%	1500	1150	1560	83 (111)
	16MB	RE503737		3—5%	1800	1400	1870	91(122)
	16MC	RE504932		3—5%	1800	1400	1870	91 (122)
	161C	RE507525	RE506881	3—5%	1800	1400	1870	100 (134)
	161D	RE507526	RE506882	3—5%	1800	1400	1870	100 (134)
	163Z	RE505927		STD	2400	850	2600	93 (125)
4045TF251	1606	RE64133	RE505927	STD	2400	850	2600	93 (125)
	1606	RE505927		STD	2400	850	2600	93 (125)
4045TF252	169P	RE522714		3—5%	3000	850	3120	119 (160)
	169Q	RE522697		3—5%	3000	850	3120	119 (160)
4045TF253	16TE	RE507257		STD	2400	850	2600	85 (114)
4045TF257	16GQ	RE503048		3—5%	1500	—	1560	83 (111)
	16LV	RE503830		3—5%	1500	—	1560	83 (111)
4045TF258	16GQ	RE503048		3—5%	1500	—	1560	83 (111)
	16LV	RE503830		3—5%	1500	—	1560	83 (111)
	16MB	RE503737		3—5%	1800	1400	1870	91 (122)
	16MC	RE504932		3—5%	1800	1400	1870	91 (122)
	16MV	RE503736		3—5%	1800	1400	1870	100 (134)
	16MW	RE504682		3—5%	1800	1400	1870	100 (134)
6068DF150	1613	RE59861		STD	2500	850	2700	93 (125)
	1678	RE60101		STD	2500	850	2700	93 (125)
	16LR	RE59861		STD	2500	850	2700	93 (125)
6068HF120	16GT	RE503051		3—5%	1500	1400	1560	155 (208)
	16LY	RE503834		3—5%	1500	1400	1560	155 (208)

Continued on next page

OURGP11.000001D -19-13OCT06-5/9

Specifications

POWER RATINGS ON DYNAMOMETER FOR OEM ENGINES

Engine Model	Injection Pump Option Code	Original Injection Pump (Part No.)	Replaced By Injection Pump (Part No.)	Governor Regulation	Rated Speed (rpm) At Full Load	Slow Idle (rpm)	No Load Fast Idle (rpm)	Power Rating kW (HP)
	16RL	RE506085		3—5%	2100	950	2200	197 (264)
	16SJ	RE506627		3—5%	2100	950	2200	197 (264)
	16TP	RE506883		3—5%	1500	1150	1560	183 (245)
	16TQ	RE506884		3—5%	1500	1150	1560	183 (245)
	16ZQ	RE509428		3—5%	2100	950	2200	197 (264)
	16ZR	RE509429		3—5%	2100	950	2200	197 (264)
6068HF150	1621	RE66575	RE505930	STD	2400	850	2600	157 (210)
	1621	RE505930		STD	2400	850	2600	157 (210)
	160D	RE69589	RE505962	STD	2400	850	2600	157 (210)
	160D	RE505962		STD	2400	850	2600	157 (210)
	16CY	RE501345		STD	2200	1350	2400	143 (192)
	16GT	RE503051		3—5%	1500	1400	1560	153 (205)
	16LY	RE503836		3—5%	1500	1400	1560	153 (205)
	16ML	RE503746		3—5%	1800	1400	1870	187 (251)
	16MM	RE504702	RE505049	3—5%	1800	1400	1870	187 (251)
	16MM	RE505049		3—5%	1800	1400	1870	187 (251)
	16QV	RE503051		3—5%	1800	1400	1870	166 (223)
	16QW	RE503836		3—5%	1800	1400	1870	166 (223)
	16TM	RE506885		3—5%	1800	—	1870	210 (282)
	16TN	RE506886		3—5%	1800	—	1870	210 (282)
6068HF157	16GT	RE503051		3—5%	1500	—	1560	155 (208)
	16LY	RE503836		3—5%	1500	—	1560	155 (208)
6068HF158	16GT	RE503051		3—5%	1500	—	1560	155 (208)
	16LY	RE503836		3—5%	1500	—	1560	155 (208)
	16ML	RE503746		3—5%	1800	1400	1870	187 (251)
	16MM	RE504702	RE505049	3—5%	1800	1400	1870	187 (251)
	16MM	RERE505049		3—5%	1800	1400	1870	187 (251)
6068HF250	1622	RE59521 <sup>a</sup>		STD	2400	850	2600	168 (225)
	1623	RE66761 <sup>a</sup>		3—5%	1800	—	1870	148 (198)
	16TV	RE506398		STD	2400	800	2550	168 (225)
	16YH	RE59969		STD	2400	850	2600	138 (185)
6068HF252	169A	RE522694		3—5%	3000	850	3120	225 (302)
	168Z	RE522415		3—5%	3000	850	3120	225 (302)
6068HF254				3—5%	2800	850	3000	226 (303)
				3—5%	2800	850	3000	184 (247)
6068HF258	16TM (12V)	RE506885		3—5%	1800	—	1870	210 (282)
	16TN (24V)	RE506886		3—5%	1800	—	1870	210 (282)
	16TP (12V)	RE506883		3—5%	1500	—	1560	183 (245)
	16TQ (24V)	RE506884		3—5%	1500	—	1560	183 (245)
6068TF120	16MX	RE503740		3—5%	1500	1400	1560	105 (141)

<sup>a</sup>In-line fuel injection pump.

Continued on next page

OURGP11.000001D -19-13OCT06-6/9

Specifications

**POWER RATINGS ON DYNAMOMETER FOR OEM ENGINES**

Engine Model	Injection Pump Option Code	Original Injection Pump (Part No.)	Replaced By Injection Pump (Part No.)	Governor Regulation	Rated Speed (rpm) At Full Load	Slow Idle (rpm)	No Load Fast Idle (rpm)	Power Rating kW (HP)
	16MY	RE505052		3—5%	1500	1400	1560	105 (141)
6068TF150	1614	RE61669	RE69789	STD	2500	850	2700	127 (170)
	1614	RE69789		STD	2500	850	2700	127 (170)
	1680	RE60105	RE69790	STD	2500	850	2700	127 (170)
	1680	RE69790		STD	2500	850	2700	127 (170)
	1681	RE60107	RE67571	3—5%	1800	1150	1870	112 (150)
	1681	RE67571		3—5%	1800	1150	1870	112 (150)
	1688	RE67572		3—5%	1800	1150	1870	112 (150)
	1696	RE67864	RE69787	STD	2500	850	2700	116 (155)
	1696	RE69787		STD	2500	850	2700	116 (155)
	1697	RE68740	RE69788	STD	2500	850	2700	116 (155)
	1697	RE69788		STD	2500	850	2700	116 (155)
	16BE	RE63559	RE501302	STD	2200	950	2400	117 (157)
	16BE	RE501302		STD	2200	950	2400	117 (157)
	16CN	RE501522	RE509681	STD	2100	950	2300	110.5 (148)
	16CN	RE509681		STD	2100	950	2300	110.5 (148)
	16CP	RE501523		STD	2200	950	2400	94 (126)
	16DK	RE70938		STD	2100	900	2300	96 (129)
	16DY	RE501758		STD	2500	850	2700	116 (155)
	16GM	RE502693		STD	2300	850	2500	110 (148)
	16GN	RE502704		STD	2400	850	2600	116 (155)
	16LS	RE67572		3—5%	1800	1150	1870	112 (150)
	16MG	RE503742		3—5%	1800	1400	1870	123 (165)
	16MH	RE504967		3—5%	1800	1400	1870	123 (165)
6068TF151	1681	RE60107	RE67651	3—5%	1800	1150	1870	112 (150)
	1681	RE67651		3—5%	1800	1150	1870	112 (150)
	16NJ	RE505358		3—5%	1800	1150	1870	112 (150)
	1696	RE69787		STD	2500	850	2700	116 (155)
6068TF152	1696	RE69787		STD	2500	850	2700	116 (155)
	16JU	RE69787		STD	2500	850	2700	116 (155)
6068TF157	16GS	RE503049		3—5%	1500	—	1560	121 (162)
	16LX	RE503834		3—5%	1500	—	1560	121 (162)
6068TF158	16GS	RE503049		3—5%	1500	—	1560	121 (162)
	165H	RE503740		3—5%	1500	—	1560	105 (141)
	165J	RE505052		3—5%	1500	—	1560	105 (141)
	16MG	RE503742		3—5%	1800	—	1870	123 (165)
	16MH	RE504966	RE504967	3—5%	1800	—	1870	123 (165)
	16MH	RE504967		3—5%	1800	—	1870	123 (165)
	16MX	RE503740		3—5%	1500	—	1560	105 (141)
	16MY	RE504699	RE505052	3—5%	1500	—	1560	105 (141)
	16MY	RE505052		3—5%	1500	—	1560	105 (141)

Continued on next page

OURGP11.000001D -19-13OCT06-7/9



Specifications

POWER RATINGS ON DYNAMOMETER FOR OEM ENGINES

Engine Model	Injection Pump Option Code	Original Injection Pump (Part No.)	Replaced By Injection Pump (Part No.)	Governor Regulation	Rated Speed (rpm) At Full Load	Slow Idle (rpm)	No Load Fast Idle (rpm)	Power Rating kW (HP)
6068TF159	16PD	RE70938		STD	2100	850	2250	96 (129)
6068TF220	16GS	RE503049		3—5%	1500	1400	1560	121 (162)
	16KK	RE502694		STD	2500	850	2700	127 (170)
	16LX	RE503836		3—5%	1500	1400	1560	121 (162)
	16RK	RE506083		3—5%	2600	850	2700	138 (185)
	16RJ	RE506084		3—5%	2100	950	2200	172 (231)
	16SG	RE506625		3—5%	2100	950	2200	172 (231)
	16SH	RE506626		3—5%	2600	850	2700	138 (185)
	16ZL	RE509424		3—5%	2100	950	2200	172 (231)
	16ZM	RE509425		3—5%	2100	950	2200	172 (231)
	16ZN	RE509426		STD	2600	850	2800	138 (185)
	16ZP	RE509427		STD	2600	850	2800	138 (185)
	165K	RE503049		3—5%	1500	—	1560	120 (161)
	165L	RE503834		3—5%	1500	—	1560	120 (161)
6068TF250	1615	RE62366	RE69791	STD	2400	850	2600	138 (185)
	1615	RE69791		STD	2400	850	2600	138 (185)
	1619	RE67573		3—5%	1800	1150	1870	124 (166)
	1668	RE59969 <sup>a</sup>		STD	2400	850	2600	138 (185)
	1685	RE67574		3—5%	1800	1150	1870	124 (166)
	1686	RE60131	RE69792	STD	2400	850	2600	138 (185)
	1686	RE69792		STD	2400	850	2600	138 (185)
	16CW	RE501344		STD	2200	950	2400	106 (142)
	16CX	RE70390		STD	2300	900	2500	128 (172)
	16GS	RE503049		3—5%	1500	1400	1560	120 (161)
	16LT	RE69791		STD	2400	850	2600	138 (185)
	16LU	RE67573		3—5%	1800	1150	1870	124 (166)
	16LX	RE503834		3—5%	1500	1400	1560	120 (161)
	16MJ	RE503744		3—5%	1800	1400	1870	142 (190)
	16MK	RE504701	RE504968	3—5%	1800	1400	1870	142 (190)
	16MK	RE504968		3—5%	1800	1400	1870	142 (190)
	163D	RE516159		STD	2200	850	2400	125 (168)
	16UG	RE506956	RE504321	STD	2400	925	2600	149(200)
	16UG	RE504321		STD	2400	925	2600	149 (200)
	16YH	RE59969		STD	2400	850	2600	138 (185)
6068TF251	1615	RE62366		STD	2400	850	2600	138 (185)
	16ZH	RE62366		STD	2400	850	2600	138 (185)
6068TF257	16GS	RE503049		3—5%	1500	—	1560	121 (162)
	16LX	RE503834		3—5%	1500	—	1560	155 (208)
6068TF258	16GS	RE503049		3—5%	1500	—	1560	121 (162)
	16LX	RE503834		3—5%	1500	—	1560	155 (208)

<sup>a</sup>In-line fuel injection pump.

Continued on next page

OURGP11.000001D -19-13OCT06-8/9

**POWER RATINGS ON DYNAMOMETER FOR OEM ENGINES**

Engine Model	Injection Pump Option Code	Original Injection Pump (Part No.)	Replaced By Injection Pump (Part No.)	Governor Regulation	Rated Speed (rpm) At Full Load	Slow Idle (rpm)	No Load Fast Idle (rpm)	Power Rating kW (HP)
	16MJ	RE503744		3—5%	1800	—	1870	142 (190)
	16MK	RE504701	RE504968	3—5%	1800	—	1870	142 (190)
	16MK	RE504968		3—5%	1800	—	1870	142 (190)

OURGP11,00001D -19-13OCT06-9/9

**Engine Crankcase Oil Fill Quantities**

*NOTE: Crankcase oil capacity may vary slightly from amount shown. ALWAYS fill crankcase to within crosshatch on dipstick. DO NOT overfill.*

To determine the option code for the oil fill quantity of your engine, refer to the engine option code label affixed to the rocker arm cover. The first two digits of the code (19) identify the oil pan option group. The last two digits of each code identify the specific oil pan on your engine.

The following table lists engine crankcase oil fill quantities for each “19\_\_” option code for these engines.

Continued on next page

OURGP11,00001E -19-31OCT06-1/4

Specifications

Engine Model	Oil Pan Option Code(s)	Crankcase Oil Capacity L (qt)		Engine Model	Oil Pan Option Code(s)	Crankcase Oil Capacity L (qt)
4045DF120	1901	7.5 (8.0)		4045TF150	1903	12.0 (12.7)
	1902	8.0 (8.5)			1904	13.5 (14.3)
	1903	12.0 (12.7)			1923	15.0 (15.8)
	1904	13.5 (14.3)			1949	12.5 (13.2)
	1923	15.0 (15.8)			19AE	14.7 (15.5)
	1949	12.0 (12.7)				
	19AE	14.7 (15.5)				
4045DF150	1901	7.5 (8.0)		4045TF151	1903	12.0 (12.7)
	1902	8.0 (8.5)			1934	12.5 (13.2)
	1903	12.0 (12.7)			1936	12.5 (13.2)
	1904	13.5 (14.3)				
	1923	15.0 (15.8)				
	1949	12.5 (13.2)				
	19AE	15.0 (15.8)				
4045DF151	1901	7.5 (8.50)		4045TF152	1937	12.5 (13.2)
4045DF152	1902	8.0 (8.5)		4045TF154	1904	13.5 (14.3)
4045DF154	1937	12.5 (13.2)		4045TF155	1937	12.5 (13.2)
4045DF151	1901	7.5 (8.50)		4045TF157	1949	12.5 (13.2)
4045DF152	1902	8.0 (8.5)		4045TF158	1949	12.5 (13.2)
4045DF154	1937	12.5 (13.2)		4045TF161	1903	12.0 (12.7)
4045HF120	1904	13.5 (14.3)		4045TF162	1903	12.0 (12.7)
	1923	15.0 (15.8)				
	1949	12.5 (13.2)				
	19AE	14.7 (15.5)				
4045HF150	1904	13.5 (14.3)		4045TF220	1903	12.0 (12.7)
	1921	16.5 (17.4)				
	1922	16.5 (17.4)				
	1923	15.0 (15.8)				
	1949	12.5 (13.2)				
	19AE	14.7 (15.5)				
4045HF152	1962	14.0 (14.8)		4045TF250	1903	12.0 (12.7)
4045HF157	1949	12.5 (13.2)		4045TF251	1904	13.5 (14.3)
4045HF158	1949	12.5 (13.2)		4045TF252	19AE	14.7 (15.5)
4045HF252	19AE	14.7 (15.5)		4045TF253	1937	12.5 (13.2)
4045HF252	19AE	14.7 (15.5)		4045TF257	1949	12.5 (13.2)
4045TF120	1903	12.0 (12.7)				

Continued on next page

OURGP11.000001E -19-31OCT06-2/4

*Specifications*

Engine Model	Oil Pan Option Code(s)	Crankcase Oil Capacity L (qt)		Engine Model	Oil Pan Option Code(s)	Crankcase Oil Capacity L (qt)
	1904	13.5 (14.3)		4045TF258	1949	12.5 (13.2)
	1923	15.0 (15.8)				
	1949	12.5 (13.2)		6068DF150	1907	19.5 (20.6)
	19AE	14.7 (15.5)			1908	19.0 (20.1)
					1909	19.0 (20.1)
					1944	20.0 (21.1)
					1948	20.0 (21.1)
					1950	20.0 (21.1)

Continued on next page

OURGP11,000001E -19-31OCT06-3/4

**Engine Crankcase Oil Fill Quantities (Continued)**

Engine Model	Oil Pan Option Code(s)	Crankcase Oil Capacity L (qt)	Engine Model	Oil Pan Option Code(s)	Crankcase Oil Capacity L (qt)			
6068TF120	1907	19.0 (20.1)	6068TF251	1909	19.0 (20.1)			
	1908	19.0 (20.1)		6068TF257	1950	20.0 (21.1)		
	1909	19.0 (20.1)			6068TF258	1950	20.0 (21.1)	
	1944	20.0 (21.1)				6068HF120	1907	19.0 (20.1)
	1956	18.0 (19.0)					1908	19.0 (20.1)
6068TF150	1907	19.0 (20.1)	1909		19.0 (20.1)			
	1908	19.0 (20.1)	1950	20.0 (21.1)				
	1909	19.0 (20.1)	1956	18.0 (19.0)				
	1944	20.0 (21.1)	1961	32.0 (34.0)				
	1948	20.0 (21.1)	6068HF150	1907	19.0 (20.1)			
	1950	20.0 (21.1)		1908	19.0 (20.1)			
	1956	18.0 (19.0)		1909	19.0 (20.1)			
6068TF151	1907	19.0 (20.1)	1924	23.7 (25.0)				
	1909	19.0 (20.1)	1944	20.0 (21.1)				
	1944	20.0 (21.1)	1948	20.0 (21.1)				
			1950	20.0 (21.1)				
6068TF152	1909	19.0 (20.1)	1956	18.0 (19.0)				
6068TF157	1950	20.0 (21.1)	1968	32.0 (34.0)				
6068TF158	1950	20.0 (21.1)	6068HF157	1950	20.0 (21.1)			
6068TF159	1963	21.5 (22.7)		6068HF158	1950	20.0 (21.1)		
6068TF220	1907	19.0 (20.1)	6068HF250		1907	19.0 (20.1)		
	1908	19.0 (20.1)		1908	19.0 (20.1)			
	1909	19.0 (20.1)		1909	19.0 (20.1)			
	1944	20.0 (21.1)		1924	23.7 (25.0)			
	1948	20.0 (21.1)		1944	20.0 (21.1)			
	1950	20.0 (21.1)		1948	20.0 (21.1)			
	1956	18.0 (19.0)		1961	32.0 (34.0)			
6068TF250	1907	19.0 (20.1)	1968	32.0 (34.0)				
	1908	19.0 (20.1)	19AC	28.0 (29.6)				
	1909	19.0 (20.1)	6068HF252	1907	19.0 (20.1)			
	1924	23.7 (25.0)		6068HF258	1968	32.0 (34.0)		
	1944	20.0 (21.1)	6068HF252		1907	19.0 (20.1)		
	1948	20.0 (21.1)			6068HF258	1968	32.0 (34.0)	
	1950	20.0 (21.1)	6068HF258			1968	32.0 (34.0)	
	1956	18.0 (19.0)			6068HF258	1968	32.0 (34.0)	
	1961	32.0 (34.0)	6068HF258			1968	32.0 (34.0)	
	19AC	28.0 (29.6)			6068HF258	1968	32.0 (34.0)	

OURGP11.000001E -19-31OCT06-4/4

## Unified Inch Bolt and Screw Torque Values

TS1671 -UN-01MAY03

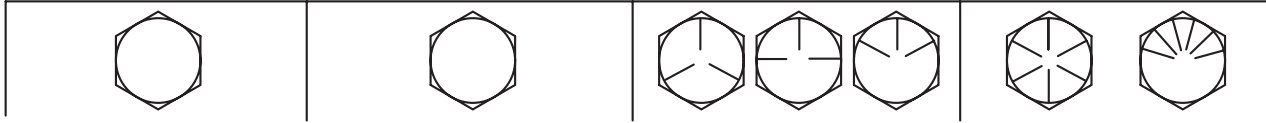

Bolt or Screw	SAE Grade 1				SAE Grade 2 <sup>a</sup>				SAE Grade 5, 5.1 or 5.2				SAE Grade 8 or 8.2			
	Lubricated <sup>b</sup>		Dry <sup>c</sup>		Lubricated <sup>b</sup>		Dry <sup>c</sup>		Lubricated <sup>b</sup>		Dry <sup>c</sup>		Lubricated <sup>b</sup>		Dry <sup>c</sup>	
Size	N•m	lb-in	N•m	lb-in	N•m	lb-in	N•m	lb-in	N•m	lb-in	N•m	lb-in	N•m	lb-in	N•m	lb-in
1/4	3.7	33	4.7	42	6	53	7.5	66	9.5	84	12	106	13.5	120	17	150
													N•m	lb-ft	N•m	lb-ft
5/16	7.7	68	9.8	86	12	106	15.5	137	19.5	172	25	221	28	20.5	35	26
									N•m	lb-ft	N•m	lb-ft				
3/8	13.5	120	17.5	155	22	194	27	240	35	26	44	32.5	49	36	63	46
			N•m	lb-ft	N•m	lb-ft	N•m	lb-ft								
7/16	22	194	28	20.5	35	26	44	32.5	56	41	70	52	80	59	100	74
	N•m	lb-ft														
1/2	34	25	42	31	53	39	67	49	85	63	110	80	120	88	155	115
9/16	48	35.5	60	45	76	56	95	70	125	92	155	115	175	130	220	165
5/8	67	49	85	63	105	77	135	100	170	125	215	160	240	175	305	225
3/4	120	88	150	110	190	140	240	175	300	220	380	280	425	315	540	400
7/8	190	140	240	175	190	140	240	175	490	360	615	455	690	510	870	640
1	285	210	360	265	285	210	360	265	730	540	920	680	1030	760	1300	960
1-1/8	400	300	510	375	400	300	510	375	910	670	1150	850	1450	1075	1850	1350
1-1/4	570	420	725	535	570	420	725	535	1280	945	1630	1200	2050	1500	2600	1920
1-3/8	750	550	950	700	750	550	950	700	1700	1250	2140	1580	2700	2000	3400	2500
1-1/2	990	730	1250	930	990	730	1250	930	2250	1650	2850	2100	3600	2650	4550	3350

Torque values listed are for general use only, based on the strength of the bolt or screw. DO NOT use these values if a different torque value or tightening procedure is given for a specific application. For plastic insert or crimped steel type lock nuts, for stainless steel fasteners, or for nuts on U-bolts, see the tightening instructions for the specific application. Shear bolts are designed to fail under predetermined loads. Always replace shear bolts with identical grade.

Replace fasteners with the same or higher grade. If higher grade fasteners are used, tighten these to the strength of the original. Make sure fastener threads are clean and that you properly start thread engagement. When possible, lubricate plain or zinc plated fasteners other than lock nuts, wheel bolts or wheel nuts, unless different instructions are given for the specific application.

<sup>a</sup>Grade 2 applies for hex cap screws (not hex bolts) up to 6. in (152 mm) long. Grade 1 applies for hex cap screws over 6 in. (152 mm) long, and for all other types of bolts and screws of any length.

<sup>b</sup>"Lubricated" means coated with a lubricant such as engine oil, fasteners with phosphate and oil coatings, or 7/8 in. and larger fasteners with JDM F13C zinc flake coating.

<sup>c</sup>"Dry" means plain or zinc plated without any lubrication, or 1/4 to 3/4 in. fasteners with JDM F13B zinc flake coating.

### Metric Bolt and Screw Torque Values

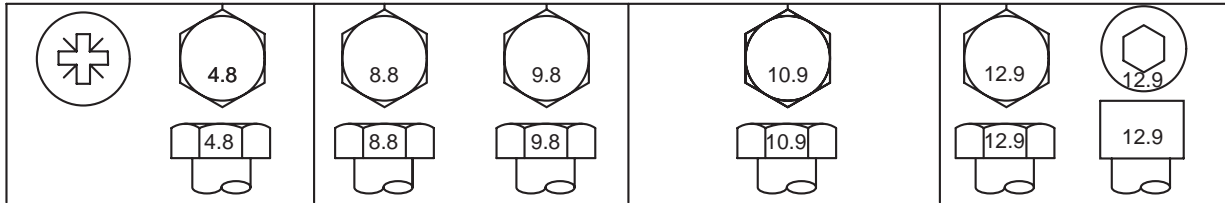

TS1670 -UN-01MAY03

Bolt or Screw	Class 4.8				Class 8.8 or 9.8				Class 10.9				Class 12.9			
	Lubricated <sup>a</sup>		Dry <sup>b</sup>		Lubricated <sup>a</sup>		Dry <sup>b</sup>		Lubricated <sup>a</sup>		Dry <sup>b</sup>		Lubricated <sup>a</sup>		Dry <sup>b</sup>	
Size	N•m	lb-in	N•m	lb-in	N•m	lb-in	N•m	lb-in	N•m	lb-in	N•m	lb-in	N•m	lb-in	N•m	lb-in
M6	4.7	42	6	53	8.9	79	11.3	100	13	115	16.5	146	15.5	137	19.5	172
									N•m	lb-ft	N•m	lb-ft	N•m	lb-ft	N•m	lb-ft
M8	11.5	102	14.5	128	22	194	27.5	243	32	23.5	40	29.5	37	27.5	47	35
			N•m	lb-ft	N•m	lb-ft	N•m	lb-ft								
M10	23	204	29	21	43	32	55	40	63	46	80	59	75	55	95	70
	N•m	lb-ft														
M12	40	29.5	50	37	75	55	95	70	110	80	140	105	130	95	165	120
M14	63	46	80	59	120	88	150	110	175	130	220	165	205	150	260	190
M16	100	74	125	92	190	140	240	175	275	200	350	255	320	235	400	300
M18	135	100	170	125	265	195	330	245	375	275	475	350	440	325	560	410
M20	190	140	245	180	375	275	475	350	530	390	675	500	625	460	790	580
M22	265	195	330	245	510	375	650	480	725	535	920	680	850	625	1080	800
M24	330	245	425	315	650	480	820	600	920	680	1150	850	1080	800	1350	1000
M27	490	360	625	460	950	700	1200	885	1350	1000	1700	1250	1580	1160	2000	1475
M30	660	490	850	625	1290	950	1630	1200	1850	1350	2300	1700	2140	1580	2700	2000
M33	900	665	1150	850	1750	1300	2200	1625	2500	1850	3150	2325	2900	2150	3700	2730
M36	1150	850	1450	1075	2250	1650	2850	2100	3200	2350	4050	3000	3750	2770	4750	3500

Torque values listed are for general use only, based on the strength of the bolt or screw. DO NOT use these values if a different torque value or tightening procedure is given for a specific application. For stainless steel fasteners or for nuts on U-bolts, see the tightening instructions for the specific application. Tighten plastic insert or crimped steel type lock nuts by turning the nut to the dry torque shown in the chart, unless different instructions are given for the specific application.

Shear bolts are designed to fail under predetermined loads. Always replace shear bolts with identical property class. Replace fasteners with the same or higher property class. If higher property class fasteners are used, tighten these to the strength of the original. Make sure fastener threads are clean and that you properly start thread engagement. When possible, lubricate plain or zinc plated fasteners other than lock nuts, wheel bolts or wheel nuts, unless different instructions are given for the specific application.

<sup>a</sup>“Lubricated” means coated with a lubricant such as engine oil, fasteners with phosphate and oil coatings, or M20 and larger fasteners with JDM F13C zinc flake coating.

<sup>b</sup>“Dry” means plain or zinc plated without any lubrication, or M6 to M18 fasteners with JDM F13B zinc flake coating.

# Lubrication and Maintenance Records

## Using Lubrication and Maintenance Records

Refer to specific Lubrication and Maintenance Section for detailed service procedures.

1. Keep a record of the number of hours you operate your engine by regular observation of hour meter.
2. Check your record regularly to learn when your engine needs service.
3. DO ALL the services within an interval section. Write the number of hours (from your service records) and the date in the spaces provided. For a

complete listing of all items to be performed and the service intervals required, refer to the quick-reference chart near the front of the Lubrication and Maintenance Section.

**IMPORTANT: The service recommendations covered in this manual are for the accessories that are provided by John Deere. Follow manufacturer's service recommendations for servicing engine driven equipment not supplied by Deere.**

RG, RG34710, 5620 -19-27JUL06-1/1

## Daily (Prestarting) Service

- Check engine oil level.
- Check coolant level.

**IMPORTANT: Drain water by rotating drain valve on fuel/water separator bowl counterclockwise. Premature injection pump failure may occur if water is not drained daily.**

- Check fuel filter/water separator bowl.
- Check air cleaner dust unloader valve and air restriction indicator, if equipped.
- Visual walkaround inspection.

RG, RG34710, 5621 -19-07JAN02-1/1



### 250 Hour/6 Month Service

- Change engine oil and filter.<sup>1</sup>
- Service fire extinguisher.
- Check engine mounts.
- Service battery.
- Check automatic belt tensioner and belt wear.

Hours									
Date									
Hours									
Date									
Hours									
Date									
Hours									
Date									
Hours									
Date									
Hours									
Date									
Hours									
Date									
Hours									
Date									

<sup>1</sup>If John Deere PLUS-50 or ACEA-E4/E5 oil is used along with a John Deere oil filter, the oil and filter change interval may be extended by 50 percent.

**500 Hour/12 Month Service**

- Clean crankcase vent tube.
- Check air intake hoses, connections, and system.
- Replace single or dual fuel filter elements.
- Check automatic belt tensioner and belt wear.
- Check engine speeds.
- Check engine electrical ground connection.
- Check cooling system.
- Coolant solution analysis – add SCAs as needed.
- Pressure test cooling system.

Hours									
Date									
Hours									
Date									
Hours									
Date									
Hours									
Date									
Hours									
Date									
Hours									
Date									
Hours									
Date									
Hours									
Date									

OURGP12,0000044 -19-07JUL04-1/1

### 2000 Hour/24 Month Service

- Check crankshaft vibration damper (6-cylinder only).
- Flush cooling system.<sup>1</sup>
- Test thermostats.
- Check and adjust valve clearance.

Hours									
Date									
Hours									
Date									
Hours									
Date									
Hours									
Date									
Hours									
Date									
Hours									
Date									
Hours									
Date									
Hours									
Date									

<sup>1</sup>If John Deere COOL-GARD is used, the flushing interval may be extended to 3000 hours, or 36 months. If John Deere COOL-GARD is used and the coolant is tested annually AND additives are replenished as needed by adding a supplemental coolant additive, the flushing interval may be extended to 5000 hours or 60 months, whichever occurs first.

### Service as Required

- Add coolant
- Service air cleaner.
- Replace poly-vee belts.
- Check fuses
- Check air compressor (if equipped).
- Bleed fuel system

Hours									
Date									
Hours									
Date									
Hours									
Date									
Hours									
Date									
Hours									
Date									
Hours									
Date									
Hours									
Date									
Hours									
Date									

OURGP12,0000045 -19-07JUL04-1/1

# Emission System Warranty

## U.S. EPA Emissions Control Warranty Statement

Emissions control-related parts and components are warranted by John Deere for five years or 3000 hours of operation, whichever occurs first. John Deere further warrants that the engine covered by this warranty was designed, built, and equipped so as to conform at the time of sale with all U.S. emissions standards at the time of manufacture, and that it is free of defects in materials and workmanship which would cause it not to meet these standards within the period of five years or 3000 hours of operation, whichever occurs first.

Warranties stated in this manual refer only to emissions-related parts and components of your engine. The complete engine warranty, less emissions-related parts and components, is provided separately as the "John Deere New Off-Highway Engine Warranty".

OUOD006,000004E -19-01NOV06-1/1

## Emissions Control System Certification Label



**CAUTION: Statutes providing severe penalties for tampering with emissions controls may apply to the user or dealer.**

The emissions warranty described above applies only to those engines marketed by John Deere that have been certified by the United States Environmental Protection Agency (EPA) and/or California Air Resources Board (CARB), and used in the United States and Canada. The presence of an emissions label like the one shown signifies that the engine has been certified with the EPA and/or CARB. The EPA and CARB warranties only apply to new engines having the certification label affixed to the engine and sold as stated above in the geographic areas. The presence of an EU number in the third line of the label signifies that the engine has been certified with the European Union countries per Directive 97/68/EC. The emissions warranty does not apply to the EU countries.

**NOTE:** *The hp/kW rating on the engine emissions certification label specifies the gross engine hp/kW, which is flywheel power without fan. In most applications this will not be the same rating as the advertised vehicle hp/kW rating.*

IMPORTANT ENGINE INFORMATION

DEERE & COMPANY



- This engine is certified to run on Diesel Fuel. This engine conforms to 2001 Model Year US EPA and California regulations on heavy-duty non road diesel cycle engines.
- Exhaust Emission Control System: EM, TC • Family No. YJDXL06.8015
- Engine Model: 6068TN052 • Displacement: 6.8 L
- Valve Clearance: Intake 0.356 mm Exhaust: 0.457 mm
- Fuel Rate: 95.7 mm<sup>3</sup>/stroke @ 200 hp [149 kW] @ 2400 rpm
- Injection Timing: 16.2 °BTDC • No Other Adjustments Required. R503149

**John Deere Engine Manufacturing**  
**For Engine Service and Parts Call 1-800-JD ENGINE**

*Emissions Label*

RG11940 -UN-17OCT01

OUOD006,000004D -19-13OCT06-1/1

# John Deere Service Literature Available

## Technical Information

Technical information can be purchased from John Deere. Some of this information is available in electronic media, such as CD-ROM disks, and in printed form. There are many ways to order. Contact your John Deere dealer. Call **1-800-522-7448** to order using a credit card. Search online from <http://www.JohnDeere.com>. Please have available the model number, serial number, and name of the product.

Available information includes:

- **PARTS CATALOGS** list service parts available for your machine with exploded view illustrations to help you identify the correct parts. It is also useful in assembling and disassembling.
- **OPERATOR'S MANUALS** providing safety, operating, maintenance, and service information. These manuals and safety signs on your machine may also be available in other languages.
- **OPERATOR'S VIDEO TAPES** showing highlights of safety, operating, maintenance, and service information. These tapes may be available in multiple languages and formats.
- **TECHNICAL MANUALS** outlining service information for your machine. Included are specifications, illustrated assembly and disassembly procedures, hydraulic oil flow diagrams, and wiring diagrams. Some products have separate manuals for repair and diagnostic information. Some components, such as engines, are available in separate component technical manuals
- **FUNDAMENTAL MANUALS** detailing basic information regardless of manufacturer:
  - Agricultural Primer series covers technology in farming and ranching, featuring subjects like computers, the Internet, and precision farming.
  - Farm Business Management series examines "real-world" problems and offers practical solutions in the areas of marketing, financing, equipment selection, and compliance.
  - Fundamentals of Services manuals show you how to repair and maintain off-road equipment.



TS189 -UN-17JAN89



TS191 -UN-02DEC88



TS224 -UN-17JAN89



TS1663 -UN-10OCT97

Continued on next page

DX.SERVLIT -19-31JUL03-1/2

75-1

110306

PN=158

- Fundamentals of Machine Operation manuals explain machine capacities and adjustments, how to improve machine performance, and how to eliminate unnecessary field operations.





# Index

Page

Page

## A

Acid burns . . . . . 30-5  
Air cleaner  
    Air intake restriction indicator . . . . . 25-1  
    Dust unloader valve . . . . . 25-1  
    Replace single stage element . . . . . 45-3  
Air compressor . . . . . 45-10  
Air intake system, check. . . . . 35-2  
Alternator belts . . . . . 45-8  
Ammeter. . . . . 15-2, 15-4  
Auxiliary gear drive, limitations . . . . . 15-9  
Aviation fuels . . . . . 10-4

## B

Batteries  
    Charge/Boost . . . . . 15-17  
    Service . . . . . 30-5  
Battery acid burns . . . . . 30-5  
Battery explosion . . . . . 30-5  
Belt tensioner  
    Manual tensioner, adjust. . . . . 30-7  
    Manual tensioner, adjust with tool. . . . . 30-8  
Belt tensioner, automatic . . . . . 35-6  
Belts, fan and alternator  
    Replacing . . . . . 45-8  
Bleeding fuel system . . . . . 45-11  
Break-in engine oil . . . . . 10-6  
Break-in, engine . . . . . 15-6  
Burner fuels . . . . . 10-4

## C

Chart, service interval. . . . . 20-2, 20-4  
Check engine electrical ground. . . . . 35-9  
Cold weather aids. . . . . 15-14  
Compressor, air . . . . . 45-10  
Coolant  
    Adding . . . . . 45-2  
    Additional information . . . . . 10-14, 10-16  
    Diesel engine . . . . . 10-12  
    Disposing . . . . . 10-18  
    Replenishing supplemental additives. . . . . 35-11  
    Supplemental additives . . . . . 10-15  
    Testing . . . . . 10-17, 35-12  
    Warm temperature climates . . . . . 10-18  
Cooling system  
    Adding coolant . . . . . 45-2

Check . . . . . 35-10  
Flush. . . . . 40-4  
Pressure test. . . . . 35-13  
Pressure test radiator cap. . . . . 35-13  
Refill . . . . . 40-4  
Crankcase vent tube, clean . . . . . 35-1  
Crankshaft vibration damper. . . . . 40-3

## D

Damper, checking. . . . . 40-3  
Diesel engine oil. . . . . 10-7  
Diesel fuel . . . . . 10-1, 10-3

## E

Emissions  
    EPA Statement . . . . . 70-1  
    Label. . . . . 70-1  
Engine  
    Break-in . . . . . 15-6  
    Check electrical ground. . . . . 35-9  
    Idling. . . . . 15-15  
    Operation . . . . . 15-13  
    Option codes. . . . . 01-3  
    Power ratings . . . . . 60-3  
    Serial number . . . . . 01-1  
    Starting . . . . . 15-10  
    Stopping . . . . . 15-16  
    Troubleshooting . . . . . 50-7  
    Warming . . . . . 15-12  
Engine coolant  
    Disposing of . . . . . 10-18  
Engine mounts  
    Checking. . . . . 30-4  
Engine oil  
    Break-In . . . . . 10-6  
    Change . . . . . 30-2  
    Diesel . . . . . 10-7  
Engine speed, changing. . . . . 15-15

## F

Fan belts . . . . . 45-8  
Filter, replace  
    Fuel . . . . . 35-3  
    Oil. . . . . 30-2

Page	Page		
Fire extinguisher, service . . . . .	30-1	<b>L</b>	
Fuel		Lubricant	
Aviation . . . . .	10-4	Mixing . . . . .	10-8
Burner . . . . .	10-4	Storage . . . . .	10-10
Diesel . . . . .	10-1, 10-3	Lubrication and Maintenance	
Handling and storing . . . . .	10-2	Service Interval Chart . . . . .	20-2, 20-4
Jet . . . . .	10-4	Lubricity of diesel fuel . . . . .	10-1
Kerosene . . . . .	10-4		
Lubricity . . . . .	10-1	<b>M</b>	
Fuel filter		Maintenance interval chart	
Checking . . . . .	25-1	Generator (Standby) applications . . . . .	20-4
Draining water . . . . .	25-1	Standard industrial applications . . . . .	20-2
Replace . . . . .	35-3	Manual belt tensioner . . . . .	30-7
Fuel injection pump model number . . . . .	01-5	Manual belt tensioner - using belt tension tool . . . . .	30-8
Fuel system		Mixing lubricants . . . . .	10-8
Bleeding . . . . .	45-11	Mounts, engine	
Fuses, checking . . . . .	45-9	Checking . . . . .	30-4
<b>G</b>			
Gauge panel . . . . .	15-2, 15-4	<b>O</b>	
Gauges . . . . .	15-2, 15-4, 15-12	Oil	
Generator (Standby) Applications . . . . .	20-4	Dipstick . . . . .	25-1
Grease		Fill quantity . . . . .	60-11
Extreme pressure and multipurpose . . . . .	10-11	Filler locations . . . . .	25-1
<b>H</b>		Oil filter, change . . . . .	30-2
Hand throttle . . . . .	15-2, 15-4	Oil filters . . . . .	10-10
<b>I</b>		Oil pressure gauge . . . . .	15-2, 15-4
Idling engine . . . . .	15-15	Operating engine	
Instrument panels . . . . .	15-2, 15-4	Break-in . . . . .	15-6
<b>J</b>		Cold weather . . . . .	15-14
Jet fuels . . . . .	10-4	Normal operation . . . . .	15-13
<b>K</b>		Option codes . . . . .	01-3
Key switch . . . . .	15-2, 15-4	<b>P</b>	
		Poly-vee belts	
		Replace . . . . .	45-8
		Power ratings . . . . .	60-3
		<b>R</b>	
		Radiator cap testing . . . . .	35-13
		Recordkeeping	
		Engine option codes . . . . .	01-3

Page

Page

Engine serial number . . . . . 01-1  
 Injection pump model number . . . . . 01-5

Vibration damper . . . . . 40-3

**S**

**W**

Serial number  
 Engine . . . . . 01-1  
 Fuel injection pump . . . . . 01-5  
 Service  
 Battery . . . . . 30-5  
 Fire extinguisher . . . . . 30-1  
 Intervals . . . . . 20-2, 20-4  
 Specifications  
 Battery capabilities . . . . . 30-5  
 Belt tensioner . . . . . 35-6  
 Damper . . . . . 40-3  
 Engine crankcase oil fill . . . . . 60-11  
 Fuel injection pump . . . . . 60-3  
 4.5 L . . . . . 60-1  
 6.8 L . . . . . 60-2  
 Standby power units . . . . . 15-9  
 Starting engine . . . . . 15-10  
 Stopping engine . . . . . 15-16  
 Storage  
 Guidelines . . . . . 55-1  
 Long term . . . . . 55-2  
 Removing from . . . . . 55-3  
 Storing fuel . . . . . 10-2  
 Storing lubricants . . . . . 10-10  
 Supplemental coolant additives  
 Replenishing . . . . . 35-11

Warming engine . . . . . 15-12  
 Wiring diagram  
 Except North America . . . . . 50-5  
 North America . . . . . 50-3

**T**

Temperature gauge (coolant) . . . . . 15-2, 15-4  
 Tensioner, belt  
 Automatic . . . . . 35-6  
 Manual . . . . . 30-7  
 Thermostat  
 Install . . . . . 40-7  
 Remove . . . . . 40-7  
 Test opening temperature . . . . . 40-7  
 Troubleshooting  
 General, engine . . . . . 50-7

**V**

Valves  
 Clearance, check and adjust . . . . . 40-10



## Free Manuals Download Website

<http://myh66.com>

<http://usermanuals.us>

<http://www.somanuals.com>

<http://www.4manuals.cc>

<http://www.manual-lib.com>

<http://www.404manual.com>

<http://www.luxmanual.com>

<http://aubethermostatmanual.com>

Golf course search by state

<http://golfingnear.com>

Email search by domain

<http://emailbydomain.com>

Auto manuals search

<http://auto.somanuals.com>

TV manuals search

<http://tv.somanuals.com>