



Powerware

**Powerware® 9390 UPS Sidecar
Installation and Operation Manual**

For use with 40–80 kVA and 100–160 kVA UPS Models

**IMPORTANT SAFETY INSTRUCTIONS
SAVE THESE INSTRUCTIONS**

This manual contains important instructions that you should follow during installation and maintenance of the UPS and batteries. Please read all instructions before operating the equipment and save this manual for future reference.

Consignes de sécurité

**CONSIGNES DE SÉCURITÉ IMPORTANTES
CONSERVER CES INSTRUCTIONS
CE MANUEL CONTIENT DES CONSIGNES DE SÉCURITÉ IMPORTANTES**

Eaton and Powerware are registered trademarks of Eaton Corporation or its subsidiaries and affiliates.

©Copyright 2004–2007 Eaton Corporation, Raleigh, NC, USA. All rights reserved. No part of this document may be reproduced in any way without the express written approval of Eaton Corporation.

Table of Contents

1	Introduction	1-1
1.1	Configurations	1-1
1.2	Using This Manual	1-4
1.3	Conventions Used in This Manual	1-5
1.4	Safety Warnings	1-6
1.5	For More Information	1-6
1.6	Getting Help	1-7
 Section I – Installation		
2	Installing the UPS Sidecar	2-1
2.1	Installation Plan and Unpacking	2-1
2.2	Preliminary Installation Information	2-1
2.3	UPS Sidecar Installation – Maintenance Bypass Configuration	2-1
2.3.1	Installing the UPS Cabinet with UPS Sidecar	2-1
2.3.2	Installing Maintenance Bypass Power Wiring	2-1
2.4	UPS Sidecar Installation – Parallel Redundant Configuration	2-4
2.4.1	Line-up-and-Match Parallel Redundant Installation	2-4
2.4.2	Installing Line-up-and-Match Parallel Redundant Power Wiring	2-7
2.4.3	Standalone Parallel Redundant Installation	2-8
2.4.4	Installing Standalone Parallel Redundant Power Wiring	2-9
2.4.5	Installing UPS Sidecar TB1 Interface Connections	2-10
2.5	Initial Startup	2-10
2.6	Completing the Installation Checklist	2-10
 Section II – Operation		
3	Understanding Operation	3-1
3.1	Maintenance Bypass Configuration	3-1
3.1.1	UPS Mode	3-1
3.1.2	Maintenance Bypass Mode with UPS Sidecar	3-2
3.2	Parallel Redundant Configuration	3-2
4	UPS Sidecar Features, Controls, and Operation	4-1
4.1	UPS Sidecar Standard Features	4-1
4.1.1	Maintenance Bypass Configuration	4-1
4.1.2	Parallel Redundant Configuration	4-1
4.1.3	Customer Interface	4-1
4.1.4	Installation Features	4-1
4.1.5	Expansion	4-1
4.2	Options	4-1
4.2.1	Bypass Input Breaker (BIB)	4-1
4.2.2	Rectifier Input Breaker (RIB)	4-2
4.2.3	System Load Breaker (SLB)	4-2
4.3	Symbols	4-2
4.4	UPS Sidecar Controls	4-3

TABLE OF CONTENTS

4.5	UPS Sidecar Operation – Maintenance Bypass Configuration	4-13
4.5.1	Using the UPS when a UPS Sidecar is Installed	4-13
4.5.2	Transferring the UPS to Maintenance Bypass	4-13
4.5.3	Transferring the UPS from Maintenance Bypass	4-14
4.6	UPS Sidecar Operation – Parallel Redundant Configuration	4-15
4.7	Maintaining the UPS Sidecar	4-15
4.8	Product Specifications	4-15
5	Warranty	5-1
6	Installation Information	A-1

List of Figures

Figure 1-1. Powerware 9390 UPS (40–80 kVA) with UPS Sidecar	1-2
Figure 1-2. Powerware 9390 UPS (100–160 kVA) with UPS Sidecar	1-3
Figure 2-1. 80 kVA UPS with UPS Sidecar	2-3
Figure 2-2. Typical Line-up-and-Match Parallel Redundant System (80 kVA System Shown)	2-4
Figure 2-3. UPM 1 to UPM 2 Joining Brackets	2-6
Figure 2-4. Typical Standalone Parallel Redundant System (80 kVA System Shown)	2-8
Figure 3-1. Path of Current Through the UPS Sidecar in UPS Mode	3-1
Figure 3-2. Path of Current Through the UPS Sidecar in Maintenance Bypass Mode	3-2
Figure 4-1. UPS Sidecar Controls (Bypass) – 40/20, 40/30, 40/40 kVA, 480/480V with MBP and MIS	4-4
Figure 4-2. UPS Sidecar Controls (Bypass) – 40/20, 40/30, 40/40 kVA, 480/480V with Optional BIB and RIB	4-5
Figure 4-3. UPS Sidecar Controls (Bypass) – 40/20, 40/30, 40/40 kVA, 208/208V and 80/40, 80/50, 80/60, 80/80 kVA and 120/100 and 120/120 kVA, 480/480V with MBP and MIS	4-6
Figure 4-4. UPS Sidecar Controls (Bypass) – 40/20, 40/30, 40/40 kVA, 208/208V and 80/40, 80/50, 80/60, 80/80 kVA and 120/100 and 120/120 kVA, 480/480V with Optional BIB and RIB	4-7
Figure 4-5. UPS Sidecar Controls (Bypass) – 80/40, 80/50, 80/60, 80/80 kVA, 208/208V and 160/100, 160/120, and 160/160 kVA, 480/480V with MBP and MIS	4-8
Figure 4-6. UPS Sidecar Controls (Bypass) – 80/40, 80/50, 80/60, 80/80 kVA, 208/208V and 160/100, 160/120, and 160/160 kVA, 480/480V with Optional BIB and RIB	4-9
Figure 4-7. UPS Sidecar Controls (Parallel Redundant) – 40/20, 40/30, 40/40 kVA, 480/480V with MOBs and Optional SLB	4-10
Figure 4-8. UPS Sidecar Controls (Parallel Redundant) – 40/20, 40/30, 40/40 kVA, 208/208V and 80/40, 80/50, 80/60, 80/80 kVA and 120/100, and 120/120 kVA, 480/480V with MOBs and Optional SLB	4-11
Figure 4-9. UPS Sidecar Controls (Parallel Redundant) – 80/40, 80/50, 80/60, 80/80 kVA, 208/208V and 160/100, 160/120, and 160/160 kVA, 480/480V with MOBs and Optional SLB	4-12

This page intentionally left blank.

Chapter 1

Introduction

The Eaton® Powerware® 9390 UPS Sidecar is designed for use with the Powerware 9390 80 kVA 208/208V and 480/480V and 160 kVA 480/480V three-phase uninterruptible power systems (UPSs). The UPS Sidecar provides maintenance bypass or tie cabinet functions with the following custom configurable features, enabling adaptation and expansion without costly electrical rework:

- Maintenance Bypass Configuration – Maintenance Bypass (MBP) and Maintenance Isolation (MIS) breakers enable power to completely bypass the UPS power module. The UPS module can then be safely serviced or replaced, without interrupting power to critical systems. An optional Bypass Input Breaker (BIB) and Rectifier Input Breaker (RIB) provide a single wiring point input to the UPS and a convenient method for removing power from the UPS when using the maintenance bypass to supply the load.
- Parallel Redundant Configuration – Module Output Breakers (MOBs) 1 and 2 enable two UPS modules to be paralleled together for redundancy. An optional System Load Breaker (SLB) provides output control to the critical load for the whole system.

The UPS Sidecar is attached to and directly integrated with the UPS cabinet and has safety shields behind the removable front panel for hazardous voltage protection. The UPS Sidecar matches the UPS cabinet in style and color. Figure 1-1 shows the Powerware 9390 UPS (40–80 kVA) with the UPS Sidecar and Figure 1-2 shows the Powerware 9390 UPS (100–160 kVA) with the UPS Sidecar.

1.1 Configurations

The following UPS Sidecar configurations are possible:

- UPS Sidecar with MBP and MIS
- UPS Sidecar with MBP, MIS, and BIB
- UPS Sidecar with MBP, MIS, BIB, and RIB
- UPS Sidecar with MOB 1 and MOB 2
- UPS Sidecar with MOB 1, MOB 2, and SLB

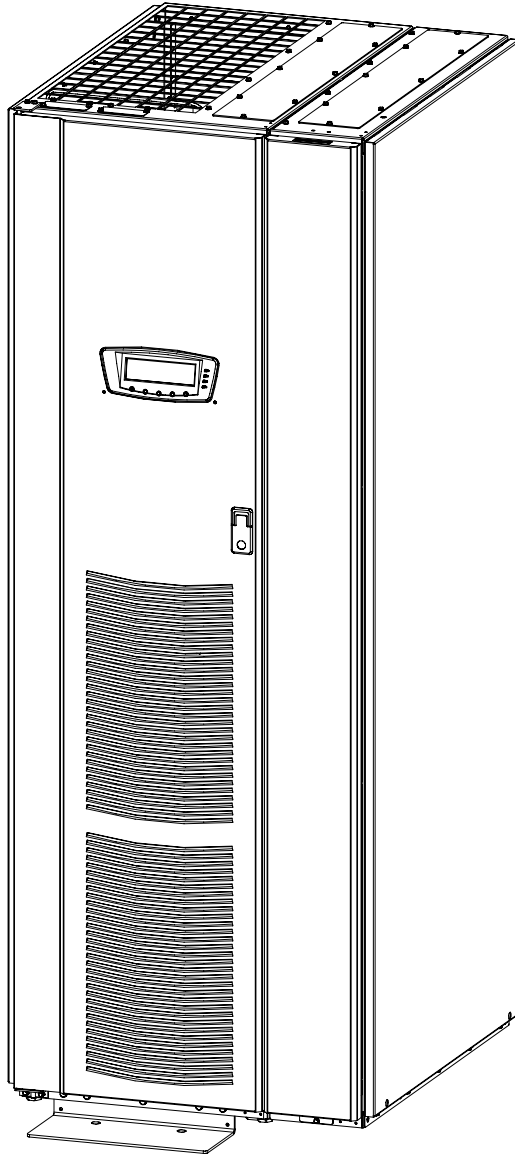

Figure 1-1. Powerware 9390 UPS (40–80 kVA) with UPS Sidecar

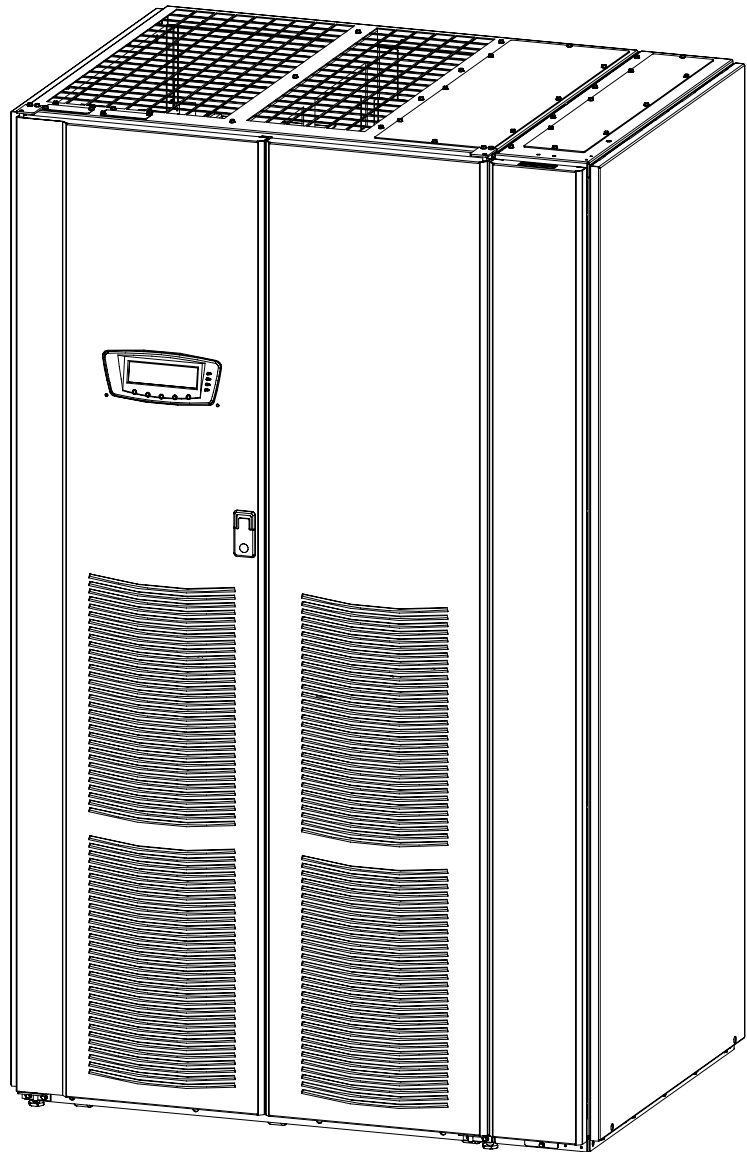

Figure 1-2. Powerware 9390 UPS (100–160 kVA) with UPS Sidecar

1.2 Using This Manual

This manual describes how to install and operate the Powerware 9390 UPS Sidecar. Read and understand the procedures described in this manual to ensure trouble-free installation and operation.

The information in this manual is divided into the sections and chapters listed. At a minimum, Chapters 1, 2, and 4 should be examined. Read through each procedure before beginning the procedure.

- **Chapter 1, "Introduction"** – provides a brief description of the UPS Sidecar, a description of the content of each chapter, text conventions used in the manual, safety warnings, and reference information.

Section I, Installation

- **Chapter 2, "Installing the UPS Sidecar"** – describes how to install and wire the UPS Sidecar.

Section II, Operation

- **Chapter 3, "Understanding Operation"** – provides information on how the UPS Sidecar works.
- **Chapter 4, "UPS Sidecar Features, Controls, and Operation"** – describes the standard and optional UPS Sidecar features, the UPS Sidecar controls, and how to use the UPS Sidecar.
- **Appendix A, "Installation Information"** – contains important information on wiring requirements and recommendations, and important diagrams of the cabinets' mechanical details and electrical access.
- **Warranty** – provides the Eaton warranty for this product.

1.3 Conventions Used in This Manual

This manual uses these type conventions:

- **Bold type** highlights important concepts in discussions, key terms in procedures, and menu options.
- *Italic type* highlights notes and new terms where they are defined.
- **Screen type** represents information that appears on the screen or LCD.

Icon	Description
	Information notes call attention to important features or instructions.

In this manual, the term *UPS* refers only to the UPS cabinet and its internal elements. The term *UPS system* refers to the entire power protection system – the UPS cabinet, the battery cabinet, the UPS Sidecar, and options or accessories installed.

The term *line-up-and-match* refers to cabinets that are physically attached to the UPS, and the wiring between them is internal. The term *standalone* refers to cabinets that are not physically attached to the UPS, and are wired with external customer-supplied wiring.

1.4 Safety Warnings

IMPORTANT SAFETY INSTRUCTIONS SAVE THESE INSTRUCTIONS

This manual contains important instructions that should be followed during installation and maintenance of the UPS Sidecar. Please read all instructions before operating the equipment and save this manual for future reference.

The UPS Sidecar is designed for industrial or computer room applications, and contains safety shields behind the front panel. However, the UPS system is a sophisticated power system and should be handled with appropriate care.

DANGER



This UPS system contains **LETHAL VOLTAGES**. All repairs and service should be performed by **AUTHORIZED SERVICE PERSONNEL ONLY**. There are **NO USER SERVICEABLE PARTS** inside the UPS.

WARNING



- The UPS system contains its own energy source (batteries). The output terminals may carry live voltage even when the UPS is disconnected from an AC source.
- To reduce the risk of fire or electric shock, install this UPS Sidecar in a temperature and humidity controlled, indoor environment, free of conductive contaminants. Ambient temperature must not exceed 40°C (104°F). Do not operate near water or excessive humidity (95% maximum). The system is not intended for outdoor use.
- Ensure all power is disconnected before performing installation or service.

CAUTION



- Never dispose of batteries in a fire. Batteries may explode when exposed to flame.
- Keep the UPS Sidecar front panel installed to protect personnel from dangerous voltages inside the unit.
- Do not operate the UPS system close to gas or electric heat sources.
- The operating environment should be maintained within the parameters stated in this manual.
- Keep surroundings uncluttered, clean, and free from excess moisture.
- Observe all DANGER, CAUTION, and WARNING notices affixed to the inside and outside of the equipment.

1.5 For More Information

Refer to the ***Powerware 9390 UPS (40–80 kVA) Installation and Operation Manual*** or the ***Powerware 9390 UPS (100–160 kVA) Installation and Operation Manual*** for the following additional information:

- UPS cabinet, optional components, and accessory installation instructions, including site preparation, planning for installation, and wiring and safety information. Detailed illustrations of cabinets and optional accessories with dimensional and connection point drawings are provided.
- UPS operation, including UPS cabinet controls, functions of the UPS, standard features and optional accessories, procedures for starting and stopping the UPS, and information about maintenance and responding to system events.
- Communication capabilities of the UPS system.

Visit www.powerware.com or contact your Eaton service representative for information on how to obtain copies of these manuals.

1.6 Getting Help

If help is needed with any of the following:

- Scheduling initial startup
- Regional locations and telephone numbers
- A question about any of the information in this manual
- A question this manual does not answer

Please call the Eaton Help Desk for Powerware products at:

United States: **1-800-843-9433** or **1-919-870-3028**
Canada: **1-800-461-9166 ext 260**
All other countries: **Call your local service representative**

This page intentionally left blank.

Section I

Installation

Chapter 2

Installing the UPS Sidecar

2.1 Installation Plan and Unpacking

Refer to the applicable Powerware 9390 installation and operation manual, listed in paragraph 1.5, for installation planning and unpacking.

2.2 Preliminary Installation Information



WARNING

Installation should be performed only by qualified personnel.

Refer to the following while installing the UPS Sidecar:

- Appendix A contains installation drawings and additional installation notes.
- Dimensions are in millimeters and inches.
- The conduit landing plates are to be removed to add conduit landing holes, or remove knockouts, as required. Plate material is 16 gauge steel (1.5 mm/0.060" thick).
- Refer to the applicable Powerware 9390 installation and operation manual, listed in paragraph 1.5, for UPS cabinet installation, wiring information, and conduit and terminal locations.

2.3 UPS Sidecar Installation – Maintenance Bypass Configuration

2.3.1 Installing the UPS Cabinet with UPS Sidecar

The UPS Sidecar is a factory-installed integral part of the standard UPS cabinet. Refer to the applicable Powerware 9390 installation and operation manual, listed in paragraph 1.5, for UPS cabinet installation.

2.3.2 Installing Maintenance Bypass Power Wiring



NOTE Remove the UPS Sidecar top or bottom conduit landing plate to drill or punch conduit holes, or remove knockouts (see Drawing 164201546-5 starting on page A-27).

NOTE Refer to the applicable Powerware 9390 installation and operation manual, listed in paragraph 1.5, for UPS cabinet wiring information and conduit and terminal locations.

NOTE If input or output neutrals are required, wire the neutrals to the neutral terminals located inside the UPS cabinet.

NOTE Wire grounds to the ground terminals located inside the UPS cabinet.

1. Verify the UPS system is turned off and all power sources are removed. Refer to the applicable Powerware 9390 installation and operation manual, listed in paragraph 1.5, for shutdown instructions.
2. If not already removed, remove the screw securing the bottom of the UPS Sidecar front panel (see Figure 2-1). Lift up the panel and remove.

3. If not already removed, remove the screws securing the internal safety shield panel and remove the panel to gain access to the terminals.



NOTE *If a Bypass Input Breaker is not installed, a minimum of two separate feeds with upstream feeder breakers, or one feed with two upstream feeder breakers, must be provided: one for the UPS and one for the UPS Sidecar bypass input. DO NOT use one feed or a single-feeder breaker to supply both the UPS and Sidecar.*

4. If wiring a single-feed system with or without a Rectifier Input Breaker, continue to Step 5; if wiring a dual-feed system with an RIB, proceed to Step 8.
5. Route the bypass input cables to the UPS Sidecar bypass terminals. See Drawing 164201546-6, starting on page A-30, for UPS Sidecar wiring access information and terminal locations.
6. Connect phase A, B, and C bypass input power wiring from the source to the bypass terminals on the UPS Sidecar.
7. Proceed to Step 12.
8. Disconnect the single-feed jumpers between BIB 1, 3, 5 terminals and RIB 1, 3, 5 terminals.
9. Route the bypass and rectifier input cables to the UPS Sidecar bypass and rectifier input terminals. See Drawing 164201546-6, starting on page A-30, for UPS Sidecar wiring access information and terminal locations.
10. Connect phase A, B, and C bypass input power wiring from the source to the bypass terminals on the UPS Sidecar.
11. Connect phase A, B, and C power wiring from the source to the UPS rectifier input terminals on the UPS Sidecar.
12. Route the output cables to the UPS Sidecar output terminals. See Drawing 164201546-6, starting on page A-30, for UPS Sidecar wiring access information and terminal locations.
13. Connect phase A, B, and C, and Neutral power wiring from the UPS Sidecar output terminals to the critical load.
14. After wiring the UPS system to the facility power and critical load, be sure to ground the system according to local and/or national electrical wiring codes.
15. When all wiring is complete, reinstall the internal safety shield panels removed in previous steps.
16. Reinstall the UPS Sidecar front panel and secure with the screw at the bottom of the panel.

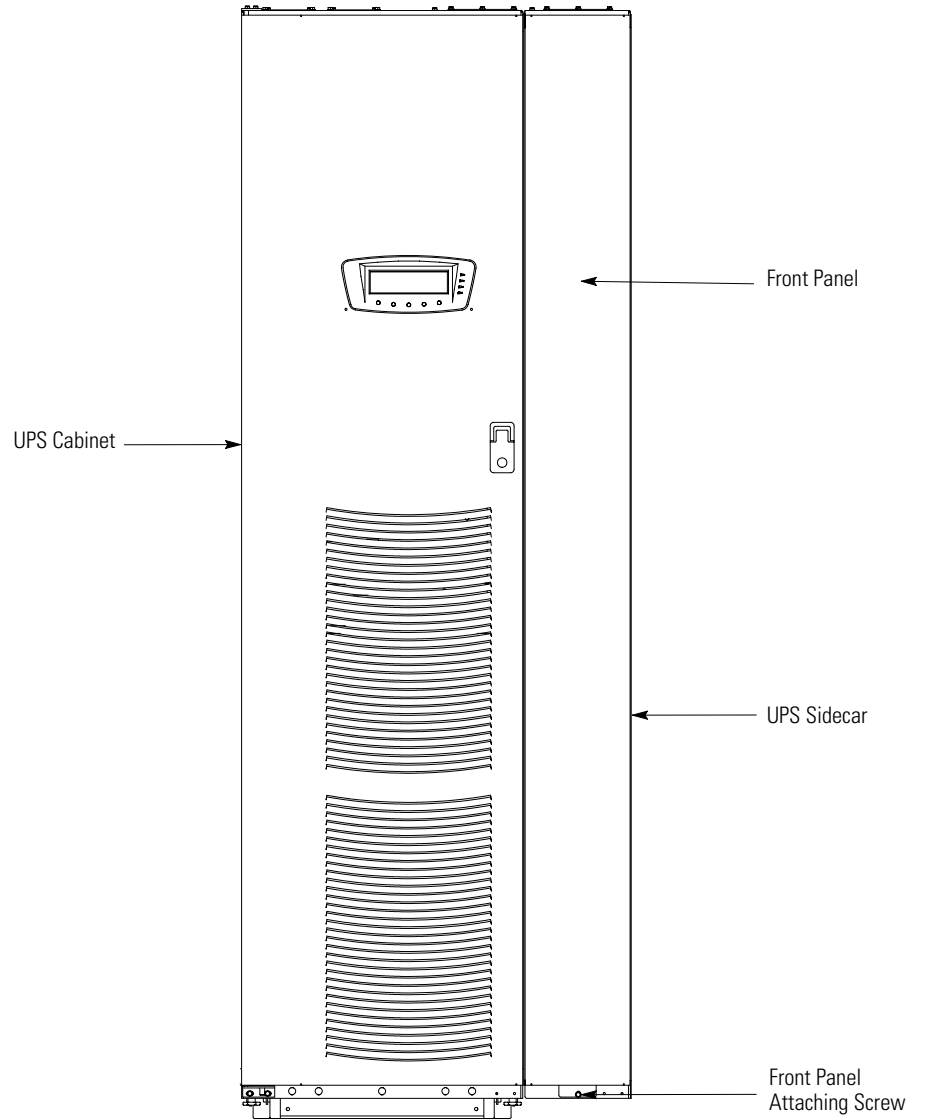

Figure 2-1. 80 kVA UPS with UPS Sidecar

2.4 UPS Sidecar Installation – Parallel Redundant Configuration

The method used to install the UPS Sidecar depends on the type of installation being undertaken. The UPS Sidecar can be installed as a *line-up-and-match* or *standalone* system.

- To install a *line-up-and-match* parallel redundant system, continue to paragraph 2.4.1.
- To install a *standalone* parallel redundant system, proceed to paragraph 2.4.3.

2.4.1 Line-up-and-Match Parallel Redundant Installation

Use this procedure to install uninterruptible power module (UPM) 2 adjacent to UPM 1 (see Figure 2-2). UPM 1 has the Sidecar installed. The UPS Sidecar is a factory-installed integral part of the standard UPS cabinet.

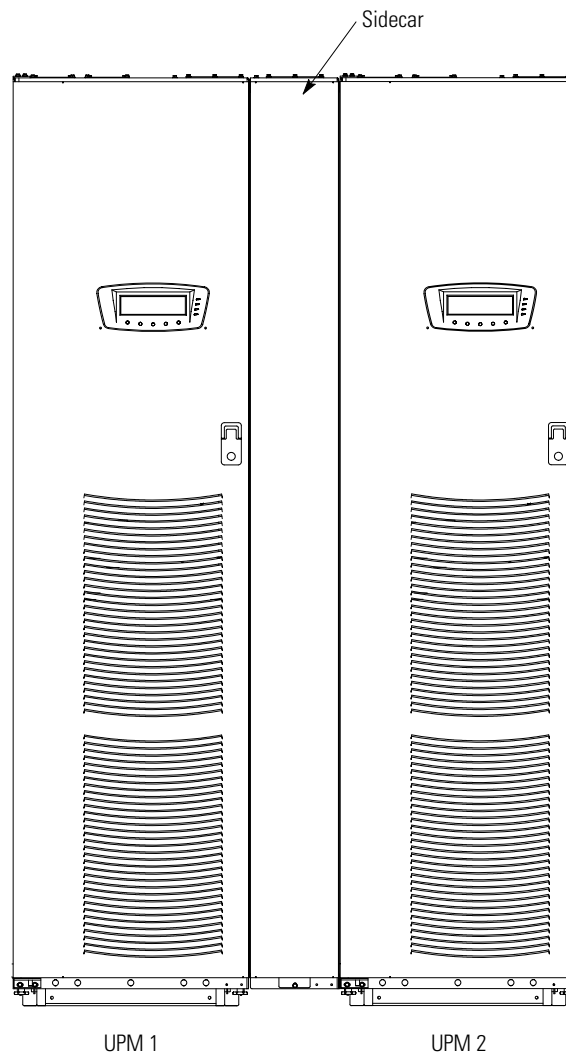

Figure 2-2. Typical Line-up-and-Match Parallel Redundant System (80 kVA System Shown)

1. Verify that the UPM 1 is properly installed and secured. Refer to the applicable Powerware 9390 installation and operation manual, listed in paragraph 1.5, for installation instructions.
2. On UPM 1, if not already removed, remove the screw securing the bottom of the UPS Sidecar front panel (see Figure 2-1 on page 2-3). Lift up the panel and remove.
3. On UPM 1, if not already removed, remove the screws securing the internal safety shield panel and remove the panel to gain access to the terminals.
4. Remove the field kit from the bottom of the UPS Sidecar and retain for later use.
5. Roll UPM 2 to an area near the right-hand side of UPM 1.
6. Open or remove doors, internal safety shield panels, and cosmetic covers, as required, according to the instructions contained in the applicable Powerware 9390 installation and operation manual, listed in paragraph 1.5.
7. Remove the knockouts, as required, on the bottom right side inside panel of the UPM 1 UPS Sidecar (see Drawing 164201546-5, sheet 3 of 3, on page A-29).
8. Remove the knockouts on the bottom left side inside panel of UPM 2. Refer to the applicable Powerware 9390 installation and operation manual, listed in paragraph 1.5, for the location of the knockout plug.
9. Install the nylon grommets from the field kit around the holes left after removing the knockouts.
10. Push UPM 2 toward the right side of UPM 1 until the doors are flush with each other.
11. If not already installed, mount the hanger brackets to the top right side of the UPM 2 using M4 screws (see Drawing 164201546-5, sheet 3 of 3, on page A-29).
12. If not already installed, hang the side panel on the hanger brackets and align with the front and rear of the UPM 2.
13. Secure UPM 2 in position. Refer to the applicable Powerware 9390 installation and operation manual, listed in paragraph 1.5, for installation instructions.



NOTE *Two cabinet joining brackets are provided in the field kit for securing each cabinet at the top and bottom. A small flat bracket joins the top of the cabinets and a larger angle bracket joins the cabinets at the bottom. The small flat bracket is attached to the cabinet tops first.*

14. Remove the left-hand screw from the top door hinge on UPM 2.
15. Locate the small flat bracket, four washers, and M4 screw from the field kit. Align the holes in the small flat bracket over the hole in the top of the UPS Sidecar attached to UPM 1 and the door hinge screw hole on UPM 2. Use the four washers between the bracket and the top of the UPS Sidecar to match the thickness of hinge on UPM 2. Secure the bracket to the UPS Sidecar using the M4 screw, and to the hinge on UPM 2 using the screw removed in Step 14 (see Figure 2-3).
16. Locate the large angle bracket, M4 screws, and large nut from the field kit. Place one end of the bracket over the bolt on the bottom side of the lower left-hand hinge on UPM 2, and loosely secure the bracket to the hinge with the large nut (see Figure 2-3).

17. Align the holes in the other end of the bracket with the holes in the bottom right-hand side of the UPS Sidecar attached to UPM 1 (see Figure 2-3). Secure the bracket with M4 screws from the field kit.
18. Secure the large nut on the UPM 2 hinge.
19. Continue to paragraph 2.4.2.

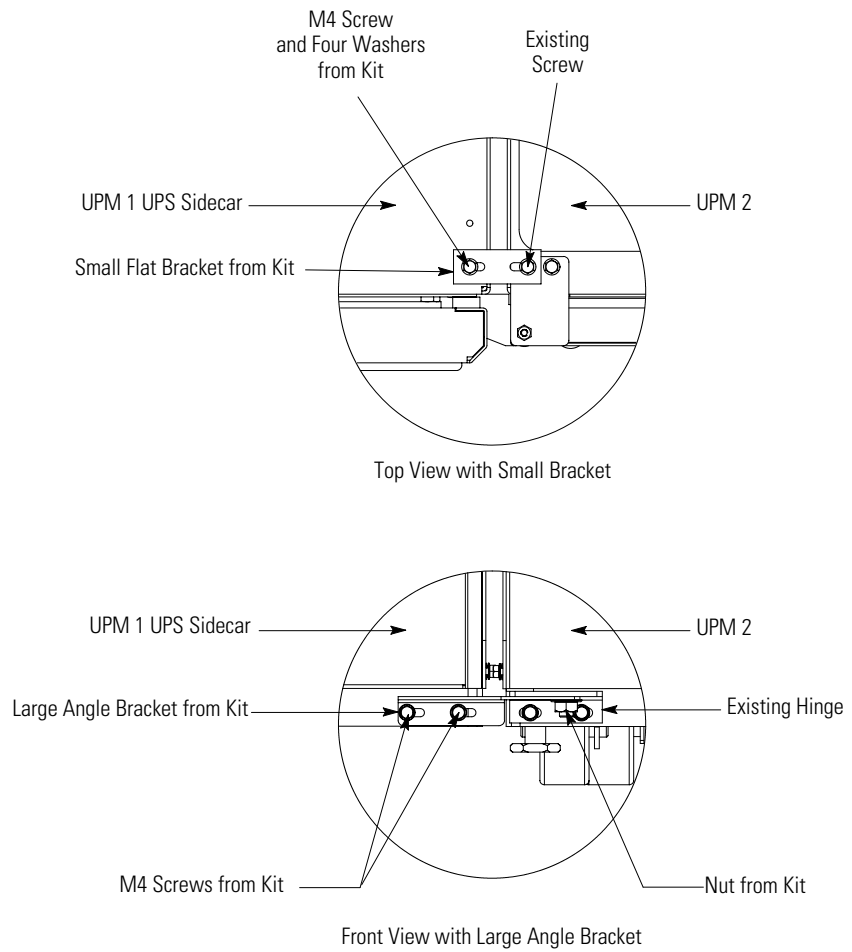

Figure 2-3. UPM 1 to UPM 2 Joining Brackets

2.4.2 Installing Line-up-and-Match Parallel Redundant Power Wiring



NOTE Remove the UPS Sidecar top or bottom conduit landing plate to drill or punch conduit holes, or remove knockouts (see Drawing 164201546-5 starting on page A-27).

NOTE Refer to the applicable Powerware 9390 installation and operation manual, listed in paragraph 1.5, for UPS cabinet wiring information and conduit and terminal locations.

CAUTION



Specified wiring and the MOB and SLB breakers for the UPS Sidecar are rated for parallel redundant service only. DO NOT use as a parallel capacity system.

1. Verify the UPS system is turned off and all power sources are removed. Refer to the applicable Powerware 9390 installation and operation manual, listed in paragraph 1.5, for shutdown instructions.
2. If not already removed, remove the screw securing the bottom of the UPS Sidecar front panel (see Figure 2-1 on page 2-3). Lift up the panel and remove.
3. If not already removed, remove the screws securing the internal safety shield panel and remove the panel to gain access to the terminals.
4. An MOB 2 to UPM 2 wiring harness is supplied inside the UPM 1 UPS Sidecar. Route the harness through the knockout in the side of the cabinets to the UPM 2 output terminals.
5. Connect phase A, B, and C, and Neutral power wiring from MOB 2 to UPM 2.
6. Route the output cables to the UPS Sidecar output terminals. See Drawing 164201546-6, starting on page A-30, for UPS Sidecar wiring access information and terminal locations.
7. Connect phase A, B, and C, and Neutral power wiring from the UPS Sidecar output terminals to the critical load.
8. After wiring the UPS system to the facility power and critical load, be sure to ground the system according to local and/or national electrical wiring codes.
9. If wiring interface connections, proceed to paragraph 2.4.5; otherwise, proceed to Step 10.
10. When all wiring is complete, reinstall the internal safety shield panels removed in previous steps.
11. Reinstall the UPS Sidecar front panel and secure with the screw at the bottom of the panel.

2.4.3 Standalone Parallel Redundant Installation

Use this procedure to install separately located UPMs (see Figure 2-4). UPM 1 has the Sidecar installed. The UPS Sidecar is a factory-installed integral part of the standard UPS cabinet.

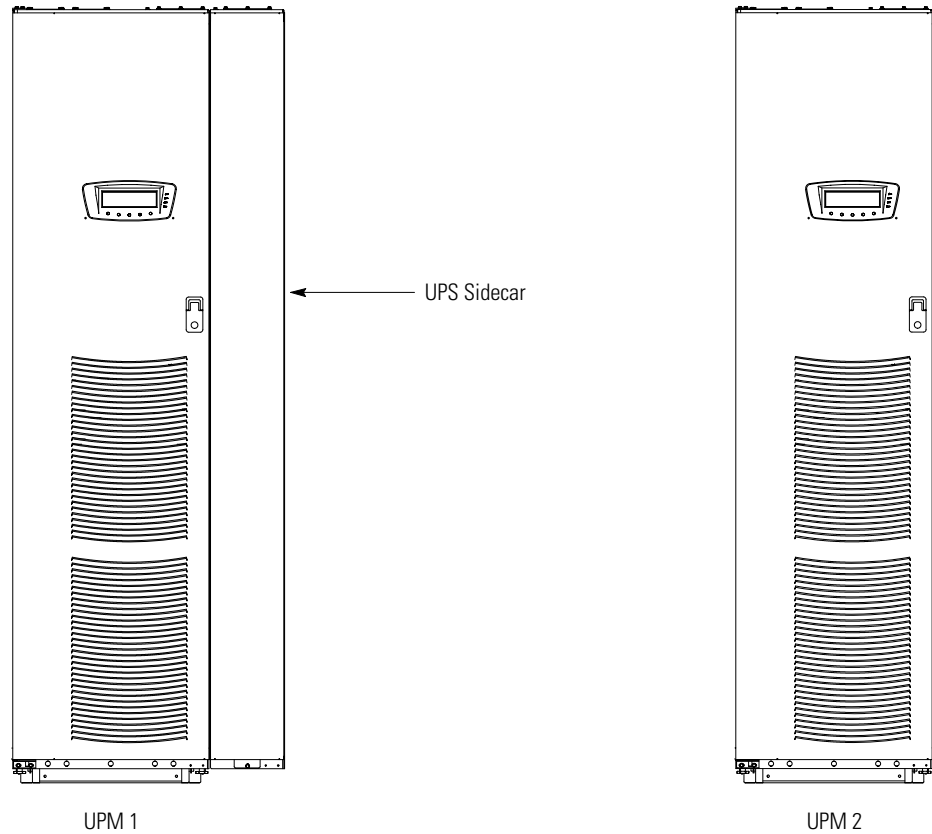

Figure 2-4. Typical Standalone Parallel Redundant System (80 kVA System Shown)

1. Verify that the UPM 1 is properly installed and secured. Refer to the applicable Powerware 9390 installation and operation manual, listed in paragraph 1.5, for installation instructions.
2. Verify that the UPM 2 is properly installed and secured. Refer to the applicable Powerware 9390 installation and operation manual, listed in paragraph 1.5, for installation instructions.
3. Continue to paragraph 2.4.4.

2.4.4 Installing Standalone Parallel Redundant Power Wiring



NOTE Remove the UPS Sidecar top or bottom conduit landing plate to drill or punch conduit holes, or remove knockouts (see Drawing 164201546-5 starting on page A-27).

NOTE Refer to the applicable Powerware 9390 installation and operation manual, listed in paragraph 1.5, for UPS cabinet wiring information and conduit and terminal locations.

CAUTION



Specified wiring and the MOB and SLB breakers for the UPS Sidecar are rated for parallel redundant service only. DO NOT use as a parallel capacity system.

CAUTION



Parallel system wiring length should be in accordance with the parallel drawings found in the appendix of the applicable Powerware 9390 installation and operation manual, listed in paragraph 1.5. Correct wire length ensures approximate equal current sharing when in Static Bypass mode.

1. Verify the UPS system is turned off and all power sources are removed. Refer to the applicable Powerware 9390 installation and operation manual, listed in paragraph 1.5, for shutdown instructions.
2. If not already removed, remove the screw securing the bottom of the UPS Sidecar front panel (see Figure 2-1 on page 2-3). Lift up the panel and remove.
3. If not already removed, remove the screws securing the internal safety shield panel and remove the panel to gain access to the terminals.
4. Route and connect output cables from UPM 2 to MOB 2 in the UPM 1 UPS Sidecar. See Drawing 164201546-6, starting on page A-30, for UPS Sidecar wiring access information and terminal locations.
5. Connect phase A, B, and C, and Neutral power wiring from UPM 2 to MOB 2.
6. Route the output cables to the UPS Sidecar output terminals. See Drawing 164201546-6, starting on page A-30, for UPS Sidecar wiring access information and terminal locations.
7. Connect phase A, B, and C, and Neutral power wiring from the UPS Sidecar output terminals to the critical load.
8. After wiring the UPS system to the facility power and critical load, be sure to ground the system according to local and/or national electrical wiring codes.
9. If wiring interface connections, proceed to paragraph 2.4.5; otherwise, proceed to Step 10.
10. When all wiring is complete, reinstall the internal safety shield panels removed in previous steps.
11. Reinstall the UPS Sidecar front panel and secure with the screw at the bottom of the panel.

2.4.5 Installing UPS Sidecar TB1 Interface Connections



NOTE When installing control wiring (such as Pull Chain and MOB auxiliary contacts) to the UPS Sidecar interface terminals, conduit must be installed between the the UPS cabinet or device and the UPS Sidecar, if wiring cannot be run through line-up-and-match cabinets. Install the control wiring in separate conduit from the power wiring.

1. Verify the UPS system is turned off and all power sources are removed. Refer to the applicable Powerware 9390 installation and operation manual, listed in paragraph 1.5, for shutdown instructions.
2. If not already removed, remove the screw securing the bottom of the UPS Sidecar front panel (see Figure 2-1 on page 2-3). Lift up the panel and remove.
3. If not already removed, remove the screws securing the internal safety shield panel and remove the panel to gain access to the terminals.
4. To locate the appropriate terminals, and for wiring and termination requirements, see Drawing 164201546-7, starting on page A-64, and refer to the applicable Powerware 9390 installation and operation manual, listed in paragraph 1.5, for UPS cabinet terminal locations.
5. Route and connect the MOB monitoring auxiliary contact wiring from the UPS Sidecar to the UPMs.
6. Route and connect the CAN and backup control (pull chain) auxiliary contact wiring from the UPS Sidecar to the UPMs.
7. When all wiring is complete, reinstall the safety shield panels removed in previous steps.
8. Reinstall the UPS Sidecar front panel and secure with screw at the bottom of the panel.

2.5 Initial Startup

Startup and operational checks must be performed by an authorized Eaton Customer Service Engineer, or the warranty terms specified on page 5-1 become void. This service is offered as part of the sales contract for the UPS system. Contact service in advance (usually a two-week notice is required) to reserve a preferred startup date.

2.6 Completing the Installation Checklist

The final step in installing the UPS Sidecar is completing the following Installation Checklist. This checklist ensures that you have completely installed all hardware, cables, and other equipment. Completing all items listed on the checklist will ensure a smooth installation. Make a copy of the Installation Checklist before filling it out, and retain the original.

After the installation is complete, a service representative will be able to verify the operation of the UPS system and commission it to support the critical load. The service representative cannot perform any installation tasks other than verifying software and operating setup parameters. Service personnel may request a copy of the completed Installation Checklist to verify all applicable equipment installations have been completed.



NOTE The Installation Checklist **MUST** be completed prior to starting the UPS system for the first time.

Installation Checklist

- All conduits and cables are properly routed to the UPS Sidecar.
- All power cables are properly sized and terminated.
- UPS Sidecar auxiliary contact signal wiring is connected from the UPS Sidecar to the UPMs.
- A ground conductor is properly installed.
- Adequate workspace exists around the UPS Sidecar and other cabinets.
- Adequate lighting is provided around all UPS system equipment.
- Startup and operational checks are performed by an authorized Eaton Customer Service Engineer.

Section II

Operation

The UPS Sidecar can be configured for either maintenance bypass or parallel redundant operation.

3.1 Maintenance Bypass Configuration

3.1.1 UPS Mode

When the Maintenance Bypass switch (MBP) is open and the Maintenance Isolation switch (MIS) is closed, conditioned and protected power from the UPS is routed through the MIS to the critical load.

If the optional Bypass Input Breaker (BIB) is installed, power is supplied to the UPS through the BIB, and the UPS rectifier and bypass input terminals are jumpered together. If the optional BIB and Rectifier Input Breaker (RIB) are installed, the UPS rectifier is supplied power through the RIB and the UPS bypass is supplied power through the BIB, for a dual-feed system. In a single-feed system, the BIB and RIB input terminals are jumpered together and power is supplied to the UPS rectifier and bypass input terminals from a single source.

Figure 3-1 shows the path of electrical power through the UPS Sidecar when operating in UPS mode.

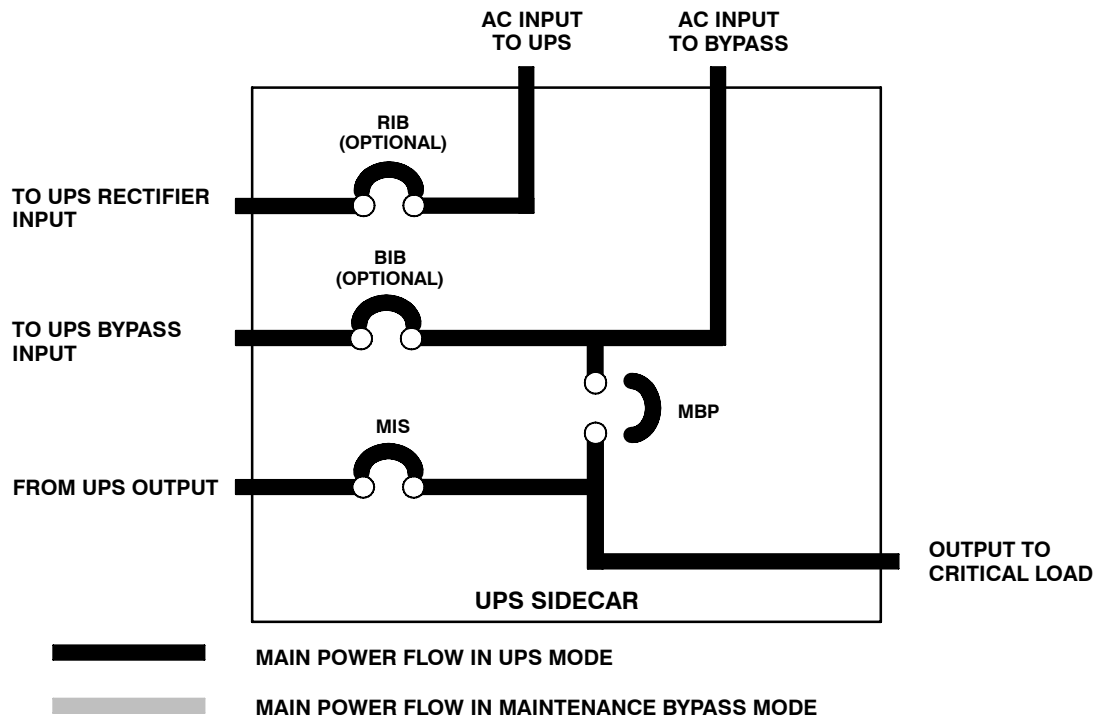

Figure 3-1. Path of Current Through the UPS Sidecar in UPS Mode

3.1.2 Maintenance Bypass Mode with UPS Sidecar

An MBP is used to safely supply utility power to the critical load during periods of UPS maintenance or repairs. The bypass source supplies the commercial AC power to the load directly.

When the MBP is closed, the load is wrapped around the UPS while power is still supplied to the load by the UPS through the MIS. The MIS is then opened, isolating the UPS from the Bypass power source. The UPS can be safely shut down and power removed from the UPS without interrupting power to the critical load. If the optional BIB and RIB are installed, the BIB and RIB are opened to remove power from the UPS. Otherwise, external upstream breakers are used to remove power. The UPS now can be serviced or replaced safely.

The critical load is not protected while the UPS is in Maintenance Bypass mode.

Figure 3-2 shows the path of electrical power through the UPS Sidecar when operating in Maintenance Bypass mode.

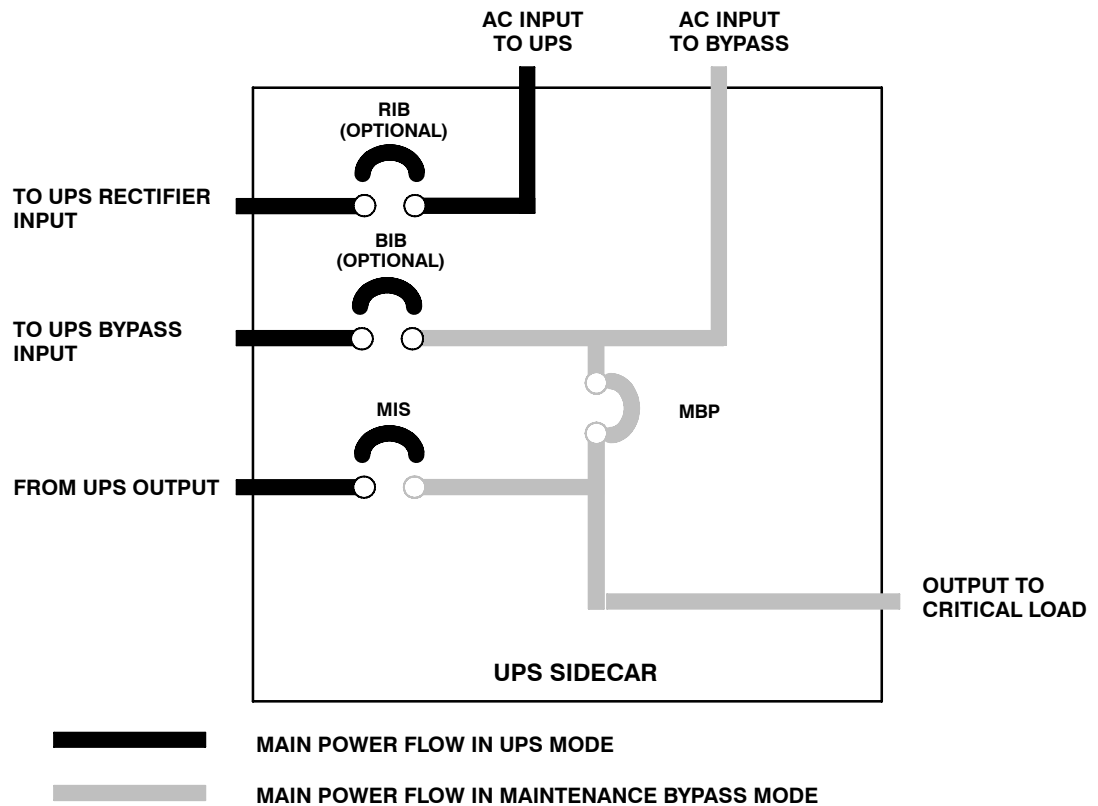

Figure 3-2. Path of Current Through the UPS Sidecar in Maintenance Bypass Mode

3.2 Parallel Redundant Configuration

Refer to the applicable Powerware 9390 installation and operation manual, listed in paragraph 1.5, for parallel theory of operation.

Chapter 4

UPS Sidecar Features, Controls, and Operation

4.1 UPS Sidecar Standard Features

The UPS Sidecar has many standard features that provide cost-effective and consistently reliable power distribution. The descriptions provide a brief overview of the UPS Sidecar controls, and standard and optional features.

4.1.1 Maintenance Bypass Configuration

A Maintenance Bypass switch (MBP), in combination with the Maintenance Isolation switch (MIS), can be used to completely isolate the UPS during service. The UPS can be serviced or replaced without interrupting power to critical systems.

4.1.2 Parallel Redundant Configuration

Module Output Breakers 1 and 2 enable two UPS modules to be paralleled together for redundancy. An optional System Load Breaker provides output control to the critical load for the whole system.

4.1.3 Customer Interface

The UPS Sidecar uses one UPS building alarm input for Maintenance Bypass Switch Monitoring. The building alarm is used to detect when the Maintenance Bypass switch is closed and the system is on bypass.

4.1.4 Installation Features

The UPS Sidecar is factory-installed to the side of the UPS cabinet. Power wiring can be routed through the top or bottom of the cabinet with connections made to easily accessible terminals. Parallel redundant modules can be installed in *line-up-and-match* or *standalone* configurations. Line-up-and-match cabinets are wired through the side panels of the units.

4.1.5 Expansion

The UPS Sidecar supports custom configurations and scalability to adapt to changing and future power and distribution needs. See paragraph 4.2 for available options.

4.2 Options

Contact your sales representative for information about any of these available options:

4.2.1 Bypass Input Breaker (BIB)

Maintenance bypass configurations have an optional BIB for single-feed and dual-feed systems. The BIB provides a single point of input power control to the UPS and easily removes power from the UPS for servicing.

4.2.2 Rectifier Input Breaker (RIB)

Maintenance bypass configurations have an optional RIB for dual-feed systems. The RIB provides a single point of rectifier input power control to the UPS and easily removes power from the UPS for servicing.

4.2.3 System Load Breaker (SLB)

Parallel redundant configurations with an optional SLB are available to control the output to the critical load for the whole system.

4.3 Symbols

The following are examples of symbols used on the UPS Sidecar to alert you to important information:



ON - Indicates the circuit breaker is in the "On" position.



OFF - Indicates the circuit breaker is in the "Off" position.



PHASE - The word "phase."



RISK OF ELECTRIC SHOCK - Indicates that a risk of electric shock is present and the associated warning should be observed.



CAUTION: REFER TO OPERATOR'S MANUAL - Refer to your operator's manual for additional information, such as important operating and maintenance instructions.



This symbol indicates that you should not discard waste electrical or electronic equipment (WEEE) in the trash. For proper disposal, contact your local recycling/reuse or hazardous waste center.

4.4 UPS Sidecar Controls

Figure 4-1 through Figure 4-8 identify and show the location of the controls on the Powerware 9390 UPS Sidecar.



NOTE Read the operation sections of this manual and the applicable Powerware 9390 installation and operation manual, listed in paragraph 1.5, and have thorough knowledge of UPS operation before attempting to operate any of the UPS Sidecar controls.

The UPS Sidecar can contain the following controls:

Maintenance Bypass Configuration

- Maintenance Bypass Switch (Standard)
- Maintenance Isolation Switch (Standard)
- Bypass Input Breaker (Optional)
- Rectifier Input Breaker (Optional)

Parallel Redundant Configuration

- Module Output Breaker 1 (Standard)
- Module Output Breaker 2 (Standard)
- System Load Breaker (Optional)

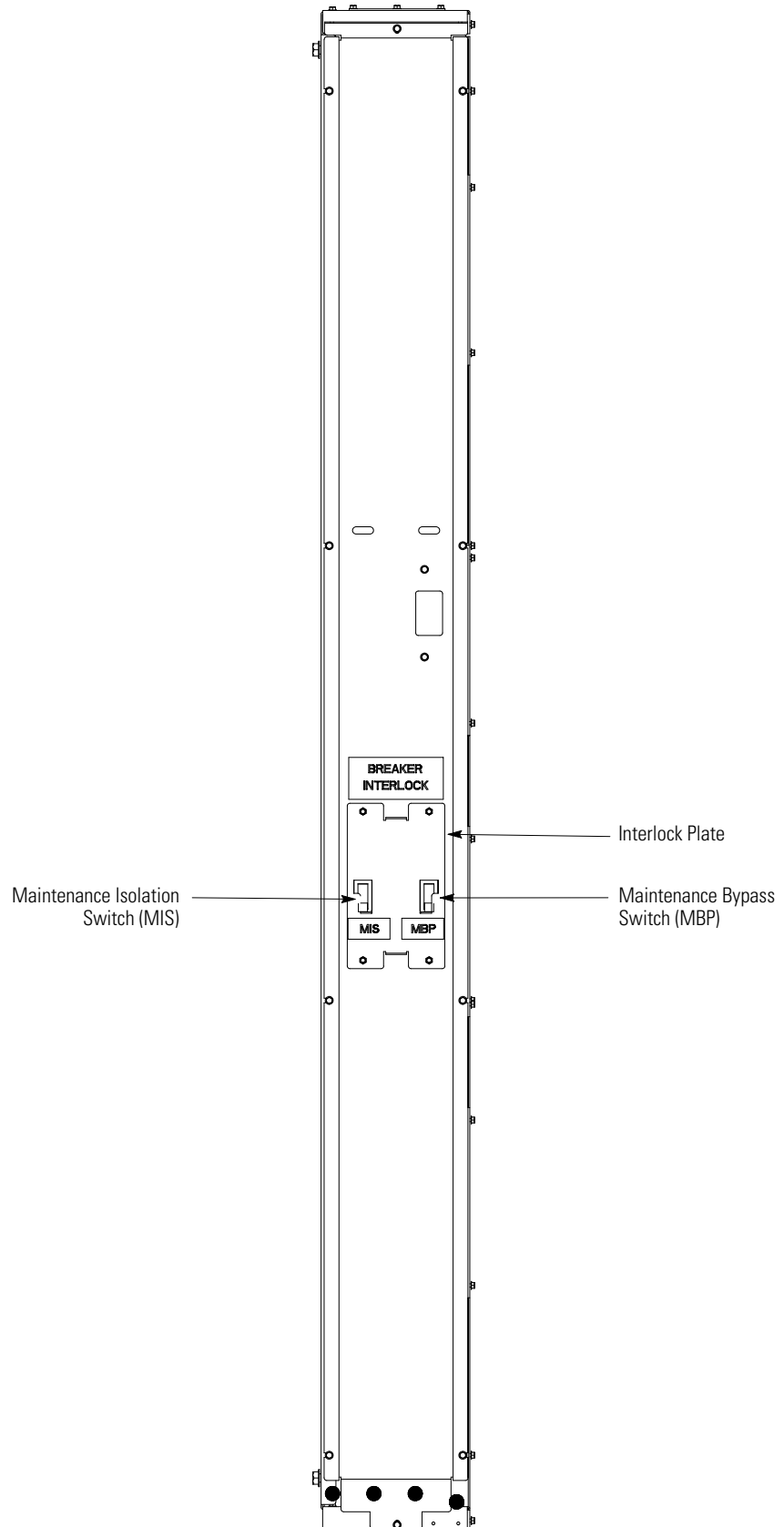

Figure 4-1. UPS Sidecar Controls (Bypass) – 40/20, 40/30, 40/40 kVA, 480/480V with MBP and MIS

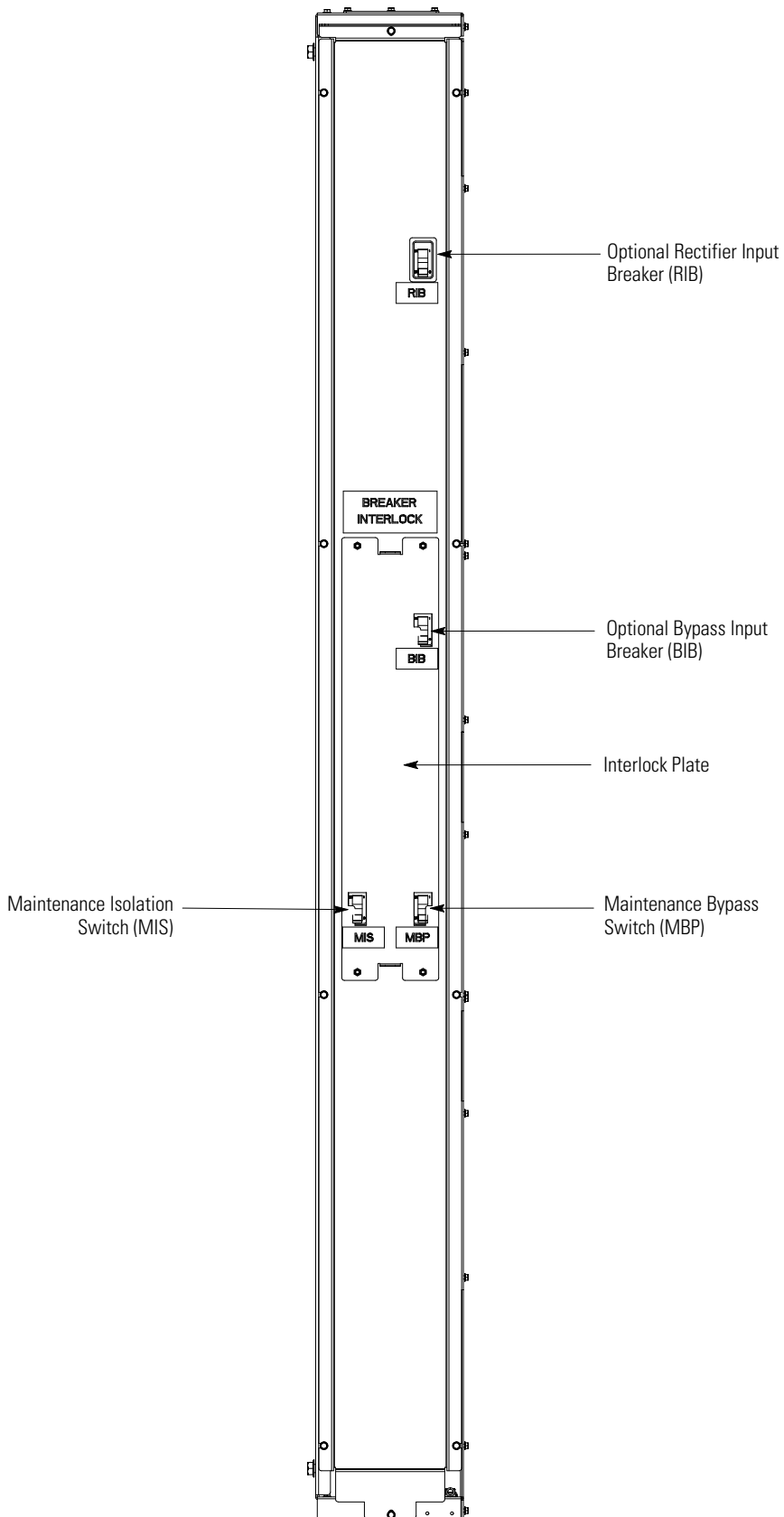

Figure 4-2. UPS Sidecar Controls (Bypass) – 40/20, 40/30, 40/40 kVA, 480/480V with Optional BIB and RIB

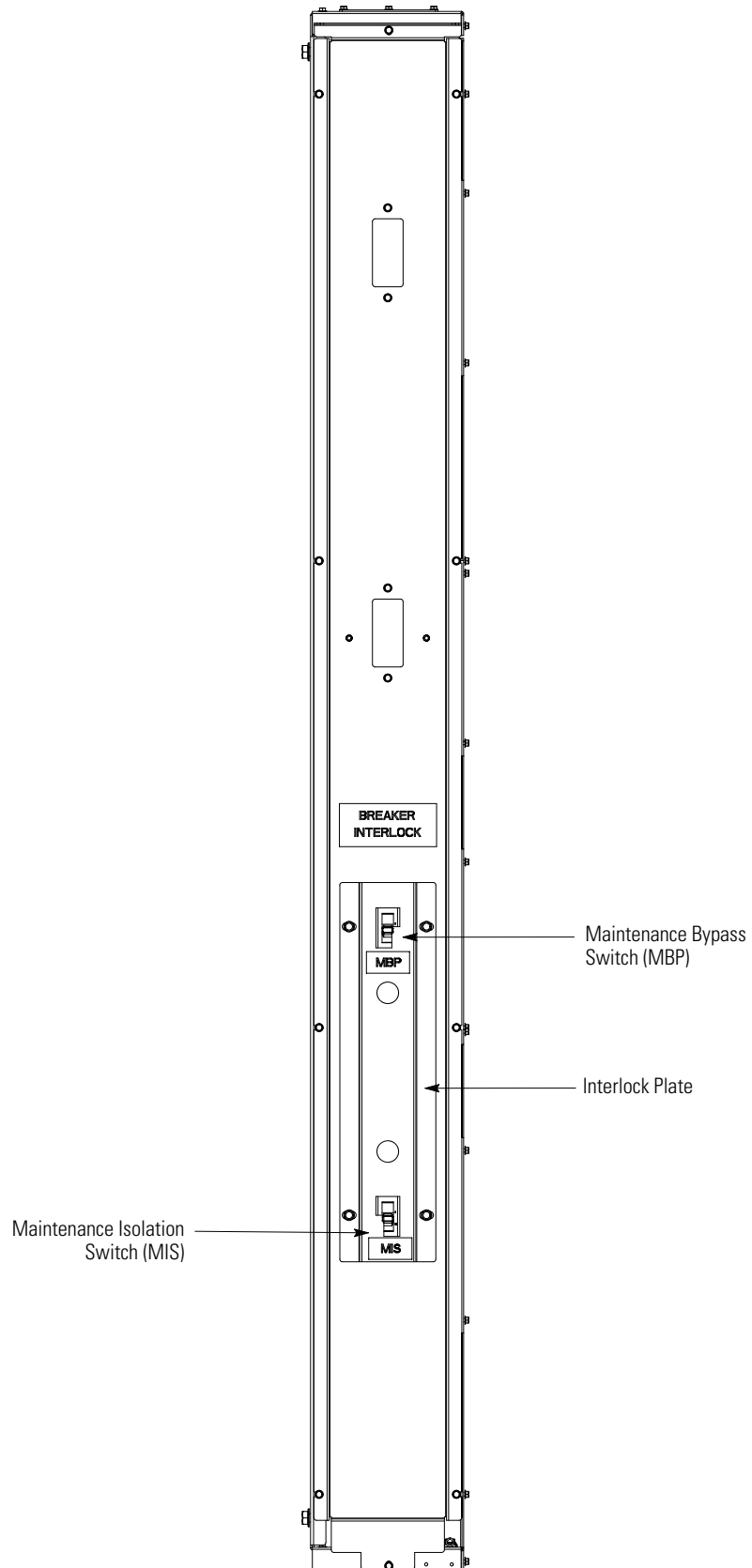

Figure 4-3. UPS Sidecar Controls (Bypass) – 40/20, 40/30, 40/40 kVA, 208/208V and 80/40, 80/50, 80/60, 80/80 kVA and 120/100 and 120/120 kVA, 480/480V with MBP and MIS

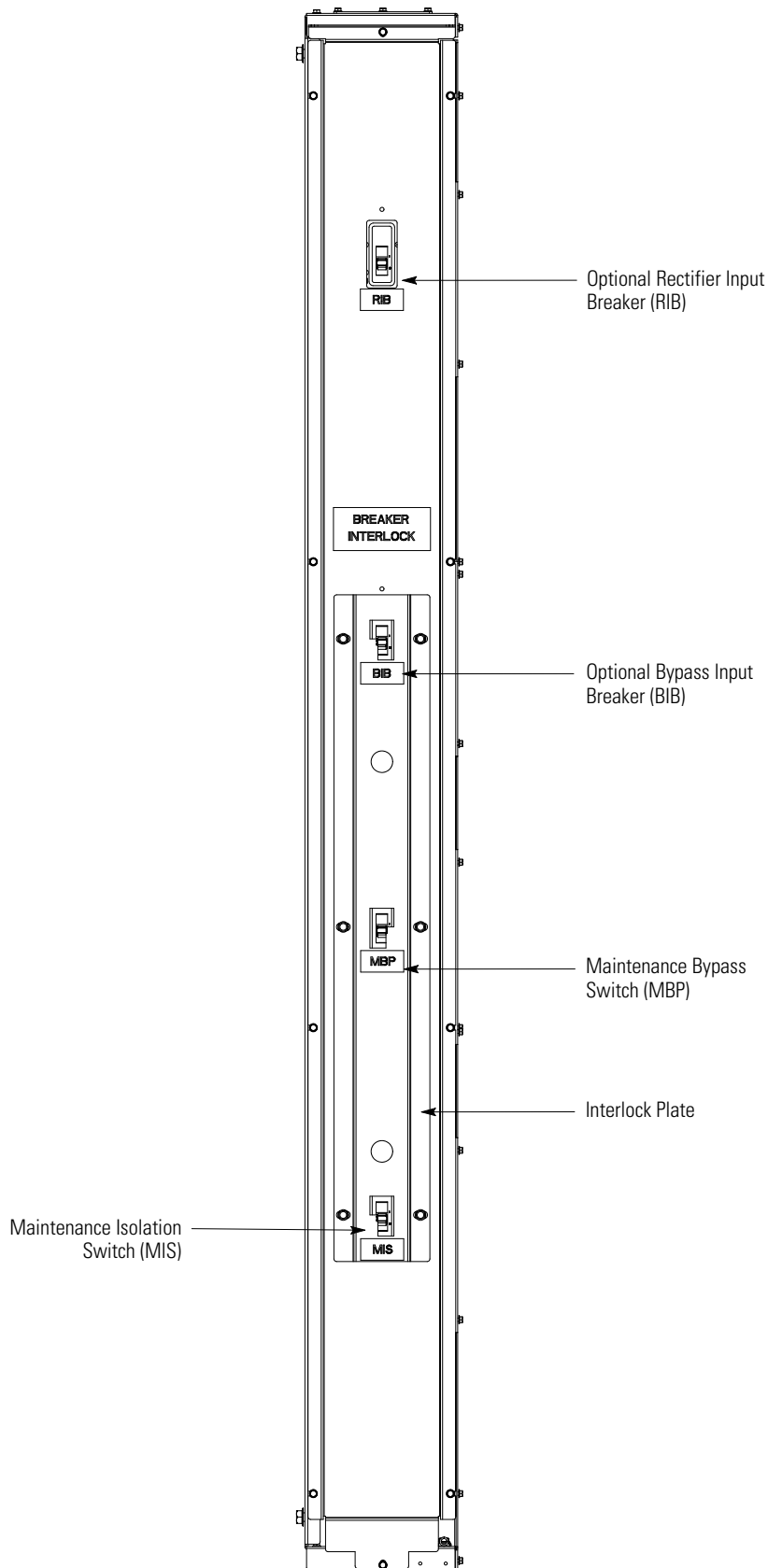

Figure 4-4. UPS Sidecar Controls (Bypass) – 40/20, 40/30, 40/40 kVA, 208/208V and 80/40, 80/50, 80/60, 80/80 kVA and 120/100 and 120/120 kVA, 480/480V with Optional BIB and RIB

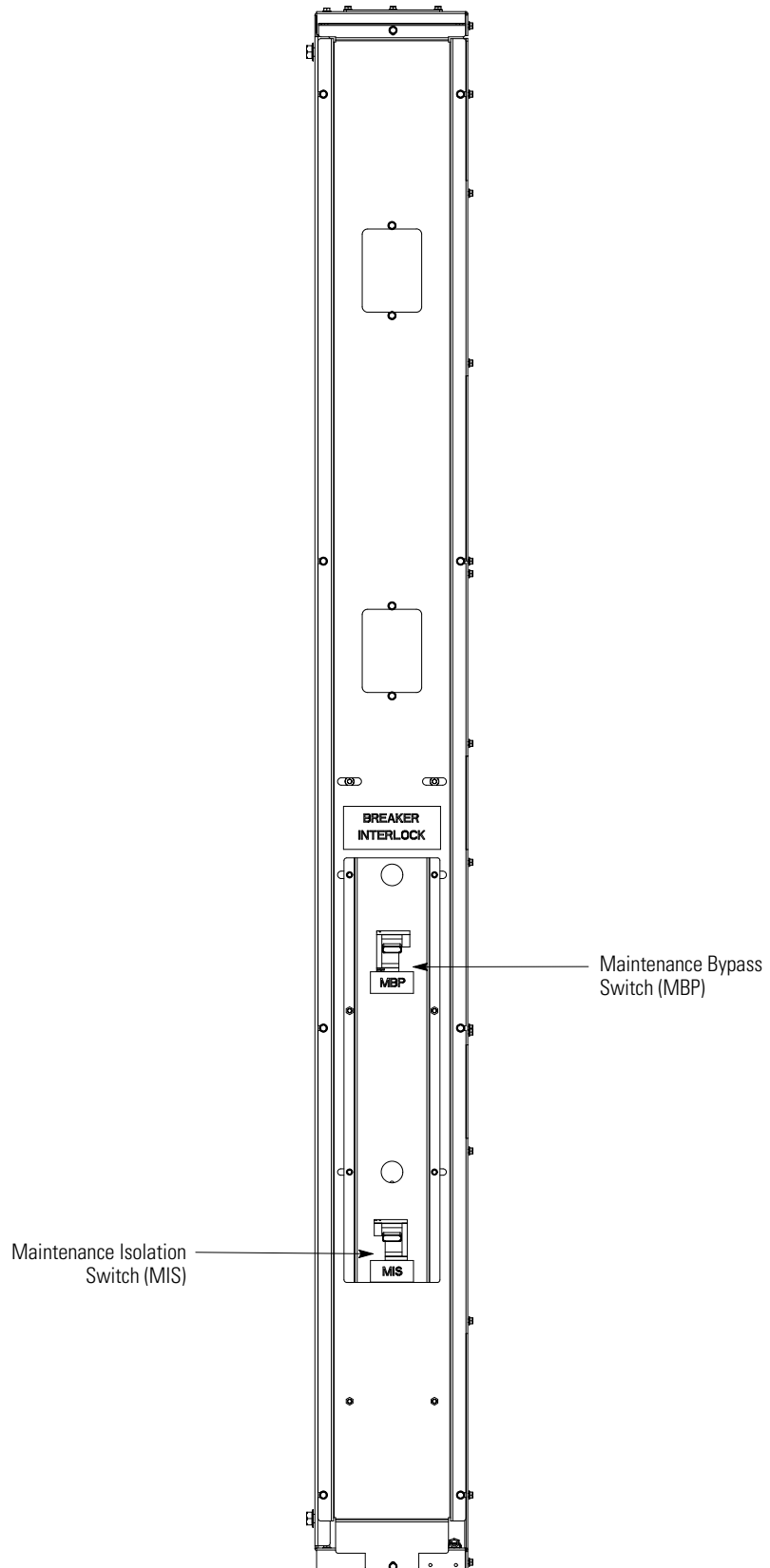

Figure 4-5. UPS Sidecar Controls (Bypass) – 80/40, 80/50, 80/60, 80/80 kVA, 208/208V and 160/100, 160/120, and 160/160 kVA, 480/480V with MBP and MIS

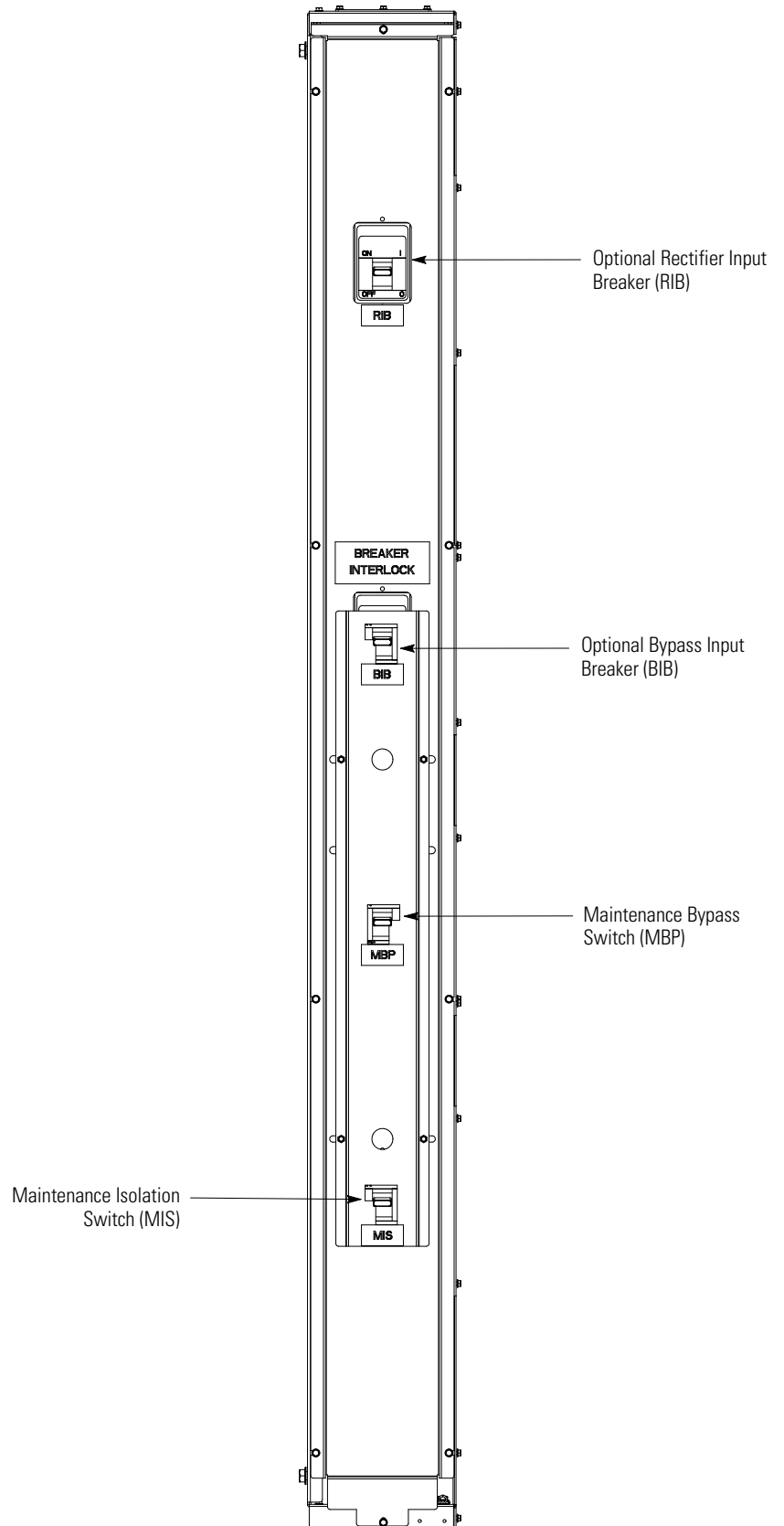

Figure 4-6. UPS Sidecar Controls (Bypass) – 80/40, 80/50, 80/60, 80/80 kVA, 208/208V and 160/100, 160/120, and 160/160 kVA, 480/480V with Optional BIB and RIB

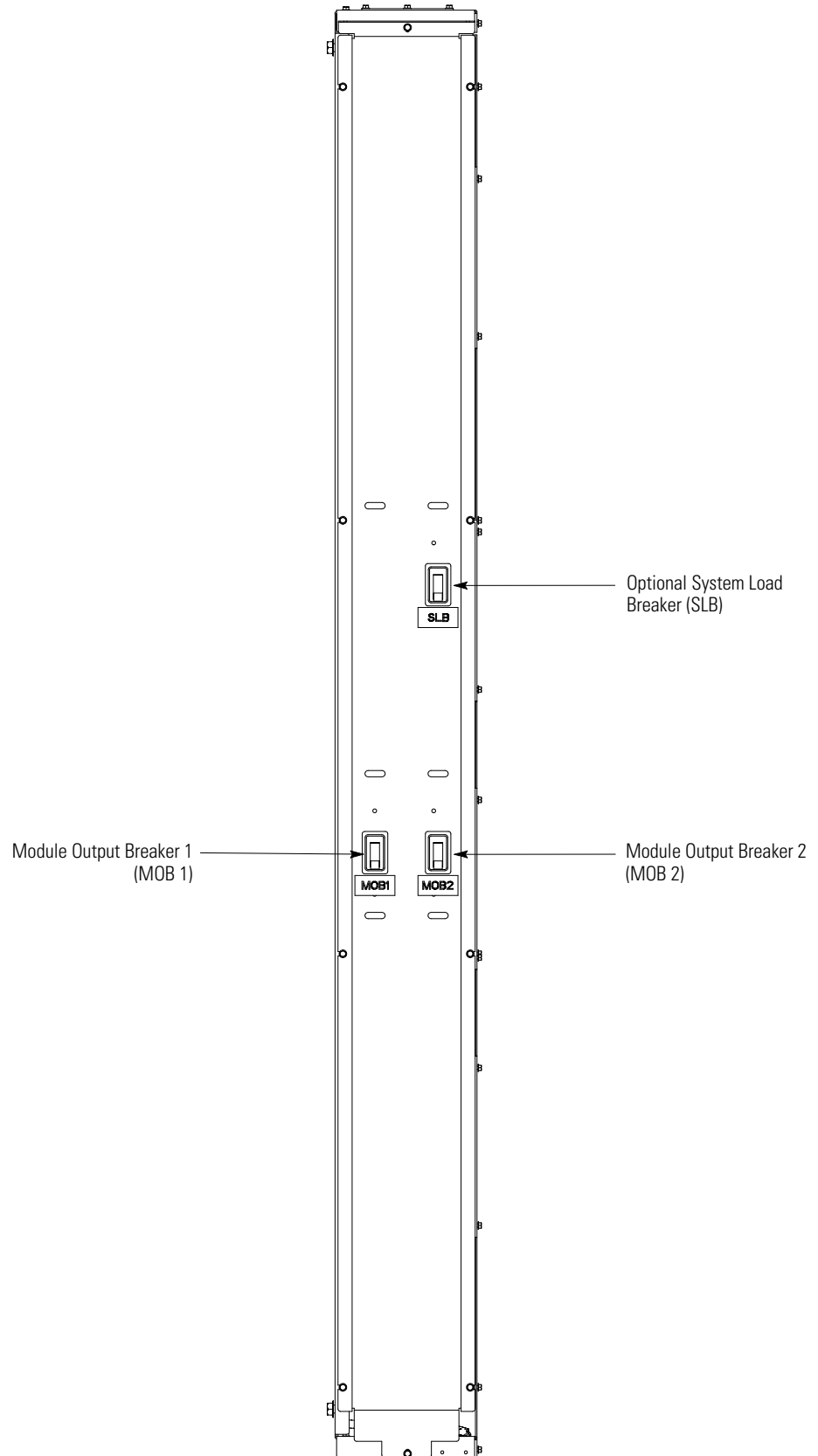

Figure 4-7. UPS Sidecar Controls (Parallel Redundant) – 40/20, 40/30, 40/40 kVA, 480/480V with MOBs and Optional SLB

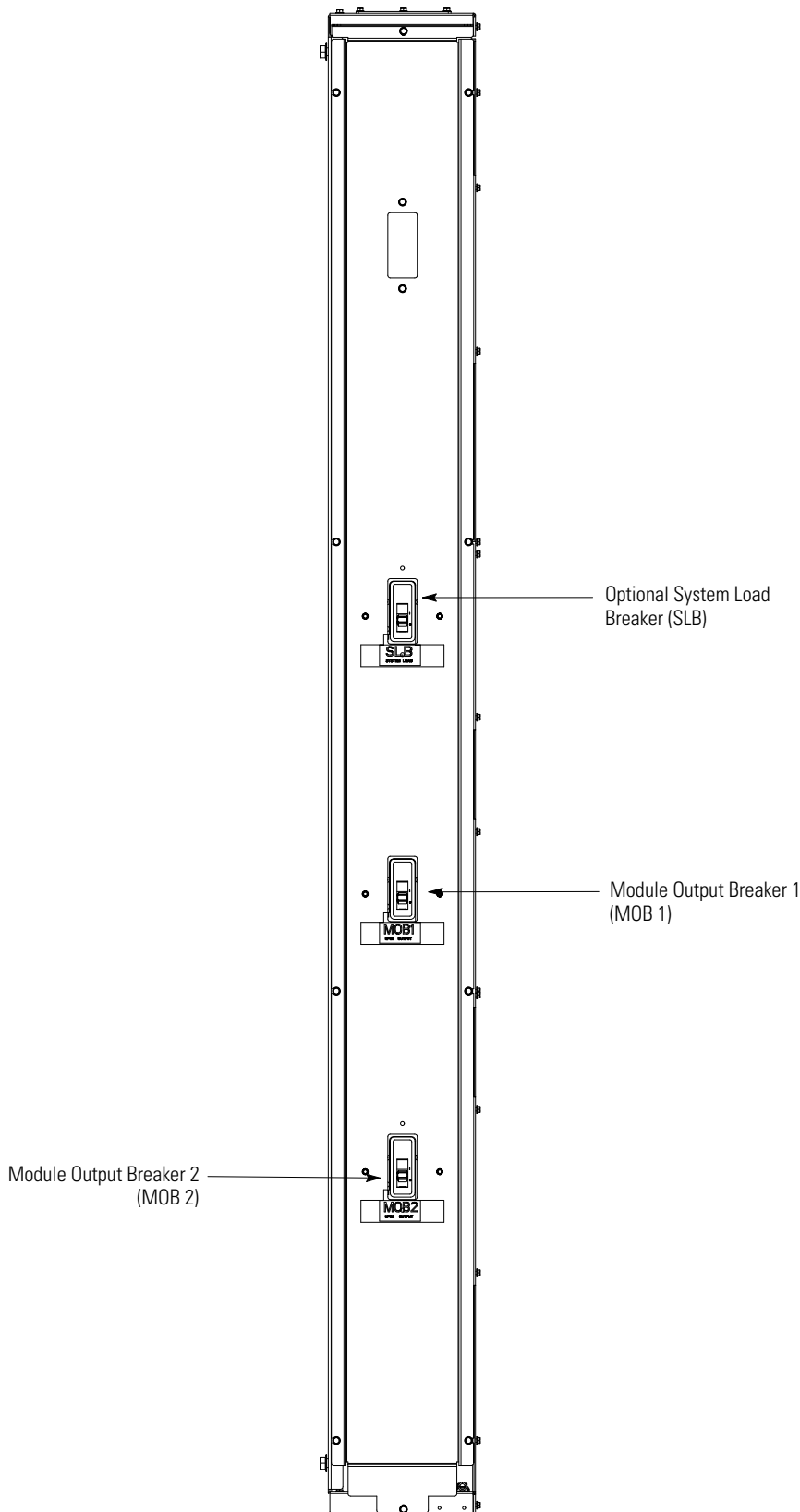

Figure 4-8. UPS Sidecar Controls (Parallel Redundant) – 40/20, 40/30, 40/40 kVA, 208/208V and 80/40, 80/50, 80/60, 80/80 kVA and 120/100, and 120/120 kVA, 480/480V with MOBs and Optional SLB

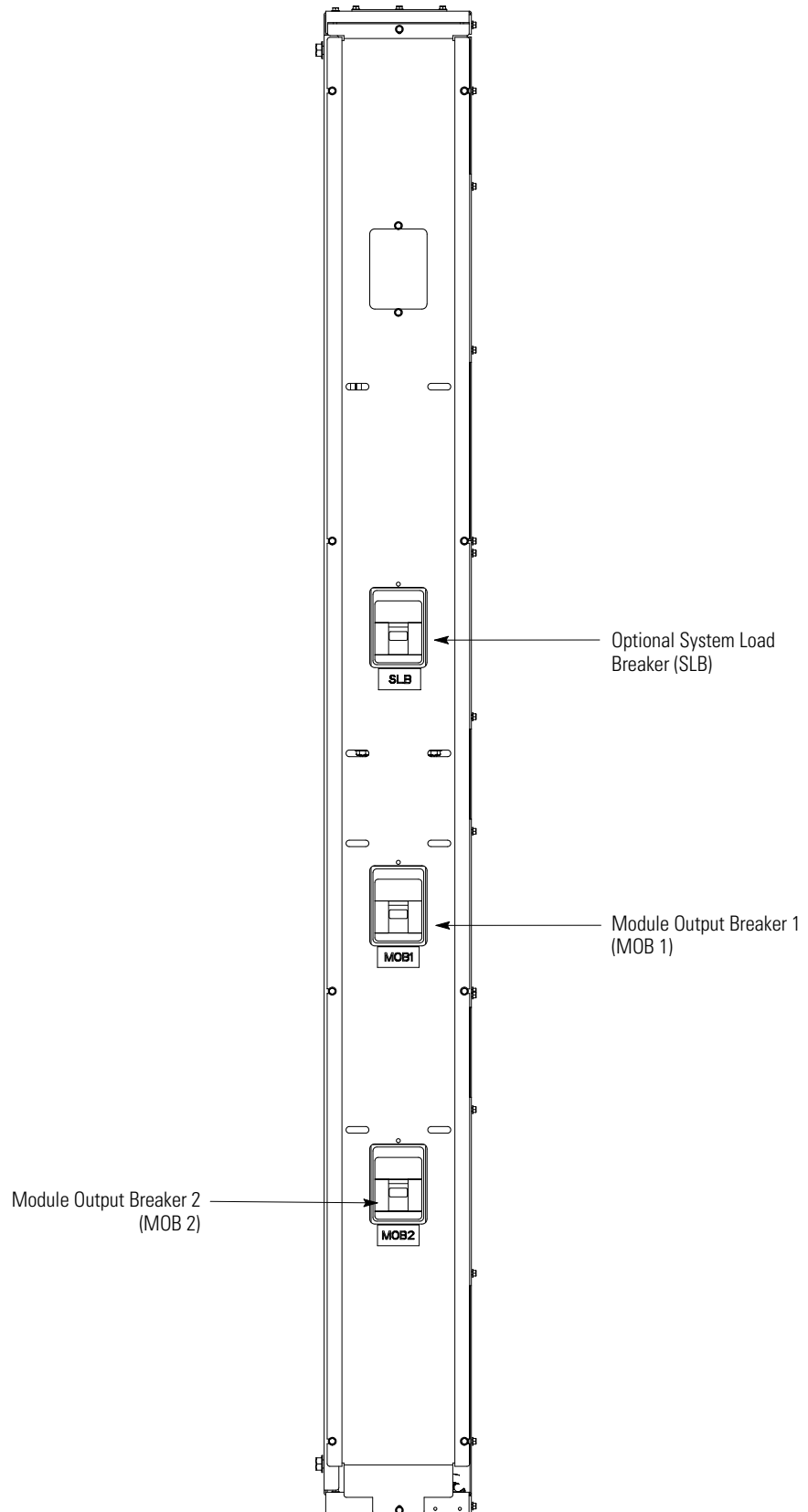

Figure 4-9. UPS Sidecar Controls (Parallel Redundant) – 80/40, 80/50, 80/60, 80/80 kVA, 208/208V and 160/100, 160/120, and 160/160 kVA, 480/480V with MOB's and Optional SLB

4.5 UPS Sidecar Operation – Maintenance Bypass Configuration

4.5.1 Using the UPS when a UPS Sidecar is Installed



NOTE Before starting the UPS with the UPS Sidecar, verify all installation tasks are complete and a preliminary startup has been performed by authorized service personnel. The preliminary startup verifies all electrical interconnections to confirm the installation was successful and the UPS operates properly.

1. Remove the screw securing the bottom of the UPS Sidecar front panel. Lift up the panel and remove.
2. Verify that the UPS Sidecar circuit breakers and switches are set as follows:

MBP	OPEN
MIS	CLOSED
BIB (if installed)	CLOSED
RIB (if installed)	CLOSED

3. Reinstall the UPS Sidecar front panel and secure with the screw at the bottom of the panel.
4. Start the UPS in Normal mode according to the instructions in the operation chapter of the applicable Powerware 9390 installation and operation manual, listed in paragraph 1.5.

4.5.2 Transferring the UPS to Maintenance Bypass

CAUTION



Only trained personnel familiar with the operation of this equipment should transfer loads. Failure to follow this transfer sequence may cause loss of power to loads or overload protection devices to activate.

CAUTION



In Bypass mode, the critical load is not protected from commercial power interruptions and abnormalities.

1. Press the **CONTROLS** pushbutton on the main menu bar. The System Controls screen appears.
2. Press the **BYPASS** pushbutton on the System Controls menu bar.

The UPS transfers to Bypass mode and the critical load is immediately supplied by the bypass source. If the bypass source is not available, the power processor remains on and an alarm sounds.

3. Verify that the **BYPASS** status indicator is illuminated, indicating the UPS is operating in Bypass mode.
4. Press the **→** pushbutton on the System Controls screen to display System Controls Screen 2.
5. Press the **PM OFF** pushbutton on the System Controls menu bar.

The PM status indicates SHUTDOWN. The input and output contactors open, the battery breaker or disconnect is tripped, and the power module is turned off. The bypass source supplies the critical load.

**WARNING**

Power is present inside the UPS cabinets.

6. Remove the screw securing the bottom of the UPS Sidecar front panel. Lift up the panel and remove.
7. Close the MBP.
8. Slide the interlock plate to the left.
9. Open the MIS.
10. Open the BIB and RIB if installed.
11. Reinstall the UPS Sidecar front panel and secure with the screw at the bottom of the panel.

4.5.3 Transferring the UPS from Maintenance Bypass**CAUTION**

Only trained personnel familiar with the operation of this equipment should transfer loads. Failure to follow this transfer sequence may cause loss of power to loads or overload protection devices to activate.

**CAUTION**

In Bypass mode, the critical load is not protected from commercial power interruptions and abnormalities.

1. Remove the screw securing the bottom of the UPS Sidecar front panel. Lift up the panel and remove.
2. Close the BIB and RIB, if installed.
3. Verify that the UPS is operating and is in Bypass mode. Refer to the applicable Powerware 9390 installation and operation manual, listed in paragraph 1.5.
4. Close the MIS.
5. Slide the interlock plate to the **NORMAL** position.
6. Open the MBP.
7. Reinstall the UPS Sidecar front panel and secure with the screw at the bottom of the panel.
8. Transfer the UPS to Normal mode by pressing the **CONTROLS** pushbutton on the main menu bar. The System Controls screen appears.
9. Press the **NORMAL** pushbutton on the System Controls menu bar.

The UPS transfers to Normal mode. If the power processor is not available, the system remains on bypass and an alarm sounds.
10. The UPS is now operating in Normal mode, and the **NORMAL** status indicator is illuminated.

4.6 UPS Sidecar Operation – Parallel Redundant Configuration

1. Remove the screw securing the bottom of the UPS Sidecar front panel. Lift up the panel and remove.
2. Verify that the UPS Sidecar circuit breakers are set as follows:

Module Output Breaker 1 (MOB 1)	CLOSED
Module Output Breaker 2 (MOB 2)	CLOSED
System Load Breaker (SLB) (if installed)	CLOSED

3. Reinstall the UPS Sidecar front panel and secure with the screw at the bottom of the panel.
4. Start the UPS in Normal mode according to the Multiple Module Parallel Operation instructions in the operation chapter of the applicable Powerware 9390 installation and operation manual, listed in paragraph 1.5.

4.7 Maintaining the UPS Sidecar

The UPS Sidecar maintenance is the same as the UPS. Refer to the applicable Powerware 9390 installation and operation manual, listed in paragraph 1.5, for maintenance instructions.

4.8 Product Specifications

The UPS Sidecar specifications are the same as the UPS. Refer to the applicable Powerware 9390 installation and operation manual, listed in paragraph 1.5, for product specifications.

This page intentionally left blank.

Chapter 5

Warranty

Limited Factory Warranty

Three-Phase Powerware UPS Products

WARRANTOR: The warrantor for the limited warranties set forth herein is Eaton Electrical Inc., a Delaware Corporation (“Eaton”).

LIMITED WARRANTY: This limited warranty (this “Warranty”) applies only to the original end-user (the “End-User”) of the Powerware Three-Phase UPS Products (the “Product”) and cannot be transferred. This Warranty applies even in the event that the Product is initially sold by Eaton for resale to an End-User.

LIMITED WARRANTY PERIOD: The period covered by this Warranty for Product installed [and currently located] in the fifty (50) United States and the District of Columbia is twelve (12) months from the date of Product startup or eighteen (18) months from the date of Product shipment, whichever occurs first, for parts coverage and 90 days from the date of Product startup for labor coverage. The period covered by this Warranty for Product installed [and currently located] outside of the fifty (50) United States and the District of Columbia is twelve (12) months from the date of Product startup or eighteen (18) months from the date of Product shipment, whichever occurs first, for parts coverage.

WHAT THIS LIMITED WARRANTY COVERS: The warrantor warrants that the Powerware three-phase UPS electronics, Eaton-built accessories, and Powerware-built battery cabinets (individually and collectively, the “Warranted Items”) are free from defects in material and workmanship. If, in the opinion of Eaton, a Warranted Item is defective and the defect is within the terms of this Warranty, Eaton’s sole obligation will be to repair or replace such defective item (including by providing service, parts, and labor, as applicable), at the option of Eaton. The Warranted Item will be repaired or replaced onsite at the End-User’s location or such other location as determined by Eaton. Any parts that are replaced may be new or reconditioned. All parts replaced by Eaton shall become the property of Eaton.

WHAT THIS LIMITED WARRANTY DOES NOT COVER: This Warranty does not cover any defects or damages caused by: (a) failure to properly store the Product before installation, including the “trickle charge” of batteries no later than the date indicated on the packaging; (b) shipping and delivery of the Product if shipping is FOB Factory; (c) neglect, accident, fire, flood, lightning, vandalism, acts of God, Customer’s neglect, abuse, misuse, misapplication, incorrect installation; (d) repair or alteration not authorized in writing by Eaton personnel or performed by an authorized Eaton Customer Service Engineer or Agent; or (e) improper testing, operation, maintenance, adjustment, or any modification of any kind not authorized in writing by Eaton personnel or performed by an authorized Eaton Customer Service Engineer or Agent.

This Warranty is not valid: (a) unless an authorized Eaton Customer Service Engineer (in the USA) or Agent (outside of the USA) performs startup and commissioning of the Product; (b) if the Product is moved to a new location by someone other than an authorized Eaton Customer Service Engineer (in the USA) or Agent (outside of the USA); or (c) if the Product’s serial numbers have been removed or are illegible. Any Warranted Items repaired or replaced pursuant to this Warranty will be warranted for the remaining portion of the original Warranty subject to all the terms thereof. Labor warranty is not provided for Product located outside of the fifty (50) United States or the District of Columbia. **Any equipment, parts, or materials included in the Product and not manufactured by Eaton are warranted solely by the manufacturer of such equipment, parts, or materials and are not included as part of this Warranty. Batteries are not warranted by Eaton.**

THIS WARRANTY IS THE END-USER’S SOLE REMEDY AND IS EXPRESSLY IN LIEU OF, AND THERE ARE NO OTHER EXPRESSED OR IMPLIED GUARANTEES OR WARRANTIES (INCLUDING ANY IMPLIED WARRANTY OF MERCHANTABILITY OR FITNESS FOR ANY PURPOSE, WHICH ARE EXPRESSLY DISCLAIMED).

LIMITATION OF LIABILITY: In no event shall Eaton be liable for any indirect, incidental, special, or consequential damages of any kind or type whatsoever, or based on any claim or cause of action, however denominated. Eaton shall not be responsible for failure to provide service or parts due to causes beyond Eaton’s reasonable control. In no case will Eaton’s liability under this Warranty exceed the replacement value of the Warranted Items.

END-USER’S OBLIGATIONS: In order to receive the benefits of this Warranty, the End-User must use the Product in a normal way, follow the Product’s user’s guide, and protect against further damage to the Product if there is a covered defect.

OTHER LIMITATIONS: Eaton’s obligations under this Warranty are expressly conditioned upon receipt by Eaton of all payments due to it (including interest charges, if any). During such time as Eaton has not received payment of any amount due to it for the Product, in accordance with the contract terms under which the Product is sold, Eaton shall have no obligation under this Warranty. Also during such time, the period of this Warranty shall continue to run and the expiration of this Warranty shall not be extended upon payment of any overdue or unpaid amounts.

COSTS NOT RELATED TO WARRANTY: The End-User shall be invoiced for, and shall pay for, all services not expressly provided for by the terms of this Warranty, including without limitation site calls involving an inspection that determines no corrective maintenance is required. Any costs for replacement equipment, installation, materials, freight charges, travel expenses, or labor of Eaton representatives outside the terms of this Warranty will be borne by the End-User.

OBTAINING WARRANTY SERVICE: In the USA, call the Eaton Customer Reliability Center 7x24 at 800-843-9433. Outside of the USA, call your local Eaton sales or service representative, or call the Eaton Customer Reliability Center in the USA at 919-870-3028. For comments or questions about this Limited Factory Warranty, write to the Customer Quality Representative, 3301 Spring Forest Road, Raleigh, North Carolina 27616 USA.

This page intentionally left blank.

Appendix A

Installation Information

The information in this appendix will help during the planning and installation of the UPS Sidecar. This appendix contains the following drawings:

- 164201546-1 Typical Powerware 9390 UPS System with UPS Sidecar
- 164201546-2 Physical Features and Requirements
- 164201546-3 UPS Sidecar Online Drawings
- 164201546-4 Power Wiring Installation Notes
- 164201546-5 Conduit and Wire Entry Locations
- 164201546-6 Power Terminal Locations
- 164201546-7 Interface and Control Wiring Installation Notes and Terminal Locations
- 164201546-8 UPS Sidecar Dimensions

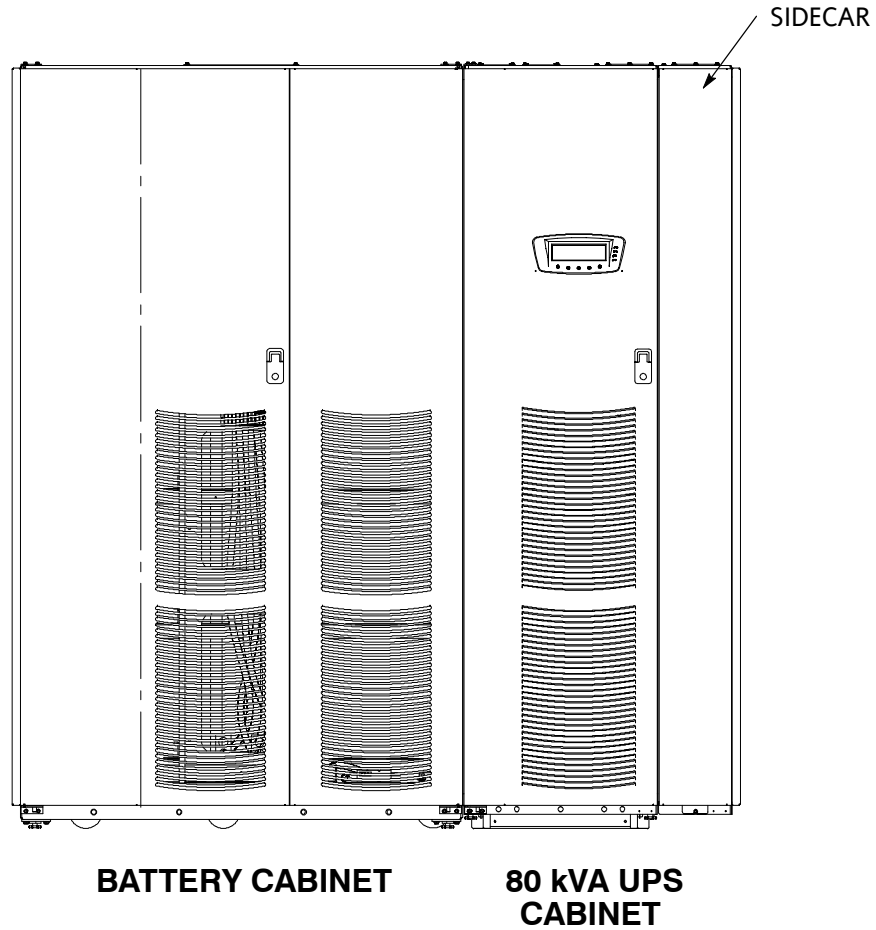

<i>DESCRIPTION:</i> TYPICAL POWERWARE 9390 UPS SYSTEM WITH UPS SIDECAR		
<i>DRAWING NO:</i>	164201546-1	<i>SHEET:</i> 1 of 3
<i>REVISION:</i>	A	<i>DATE:</i> 031505

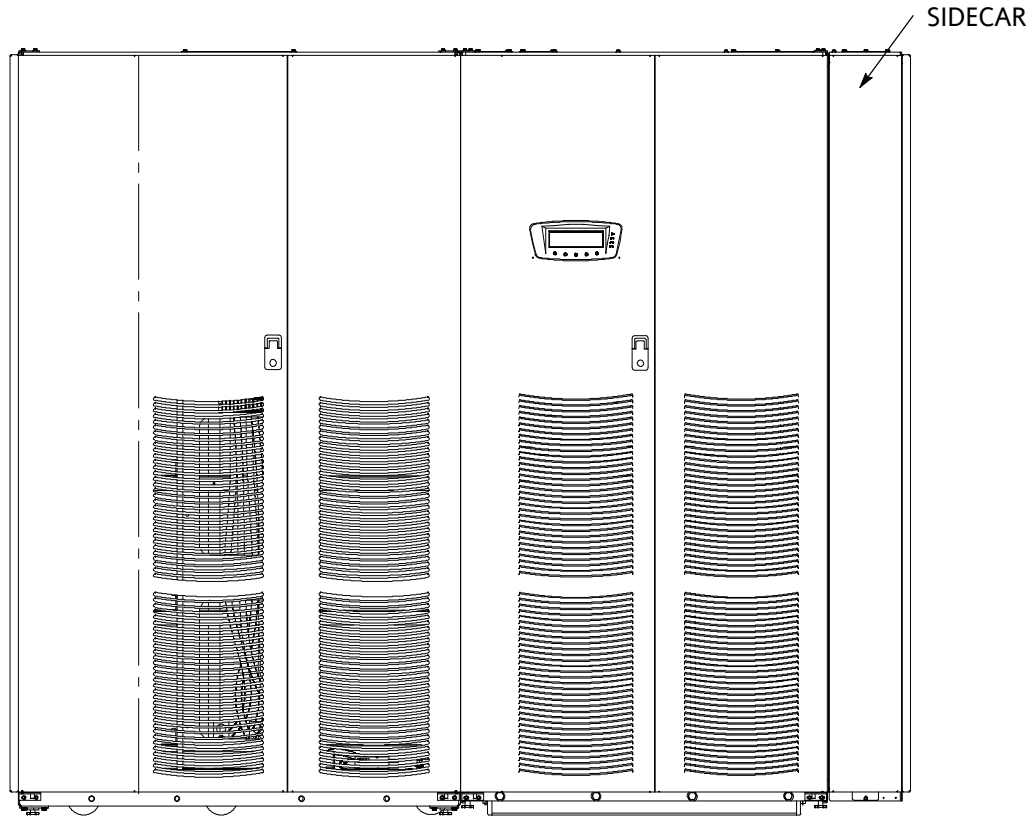

BATTERY CABINET

**160 kVA UPS
CABINET**

**TYPICAL MAINTENANCE BYPASS OR
STANDALONE PARALLEL REDUNDANT CONFIGURATION**

<i>DESCRIPTION:</i> TYPICAL POWERWARE 9390 UPS SYSTEM WITH UPS SIDECAR	
<i>DRAWING NO:</i> 164201546-1	<i>SHEET:</i> 2 of 3
<i>REVISION:</i> A	<i>DATE:</i> 031505

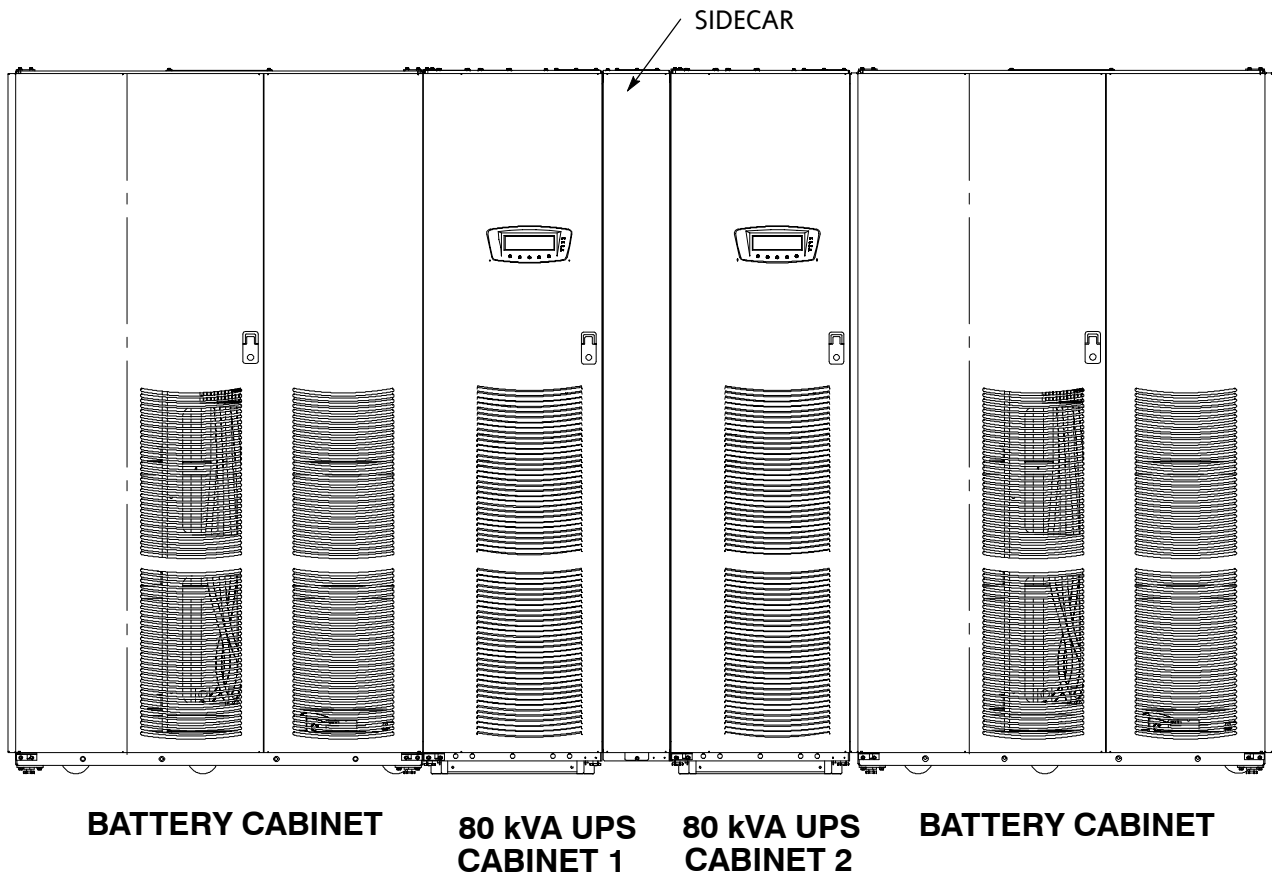

TYPICAL LINE-UP-AND-MATCH PARALLEL REDUNDANT CONFIGURATION

<i>DESCRIPTION:</i> TYPICAL POWERWARE 9390 UPS SYSTEM WITH UPS SIDECAR	
<i>DRAWING NO:</i> 164201546-1	<i>SHEET:</i> 3 of 3
<i>REVISION:</i> A	<i>DATE:</i> 031505

1. The UPS Sidecar equipment operating environment must meet the weight requirements shown in the applicable Powerware 9390 installation and operation manual, listed in paragraph 1.5, plus 150 pounds for the UPS Sidecar. Size requirements are shown in Drawing 164201546–8 starting on page A–68.
2. Do not tilt cabinets more than 10° during handling.
3. Dimensions are in millimeters (inches).
4. The clearances required around the UPS Sidecar cabinet are shown in Table A.

From Top of Cabinet	Minimum clearance over the UPS Sidecar is 457.2 mm (18") for ventilation
From Front of Cabinet	914.4 mm (36") working space
From Back of Cabinet	None Required
From Right Side of Cabinet	None Required

5. The basic environmental requirements for operation of the UPS Sidecar are:

Ambient Temperature Range: 0–40° C (32–104° F)

Recommended Operating Range: 20–25° C (68–77° F)

Maximum Relative Humidity: 95% noncondensing

<i>DESCRIPTION:</i> PHYSICAL FEATURES AND REQUIREMENTS	
<i>DRAWING NO:</i> 164201546–2	<i>SHEET:</i> 1 of 1
<i>REVISION:</i> A	<i>DATE:</i> 031505

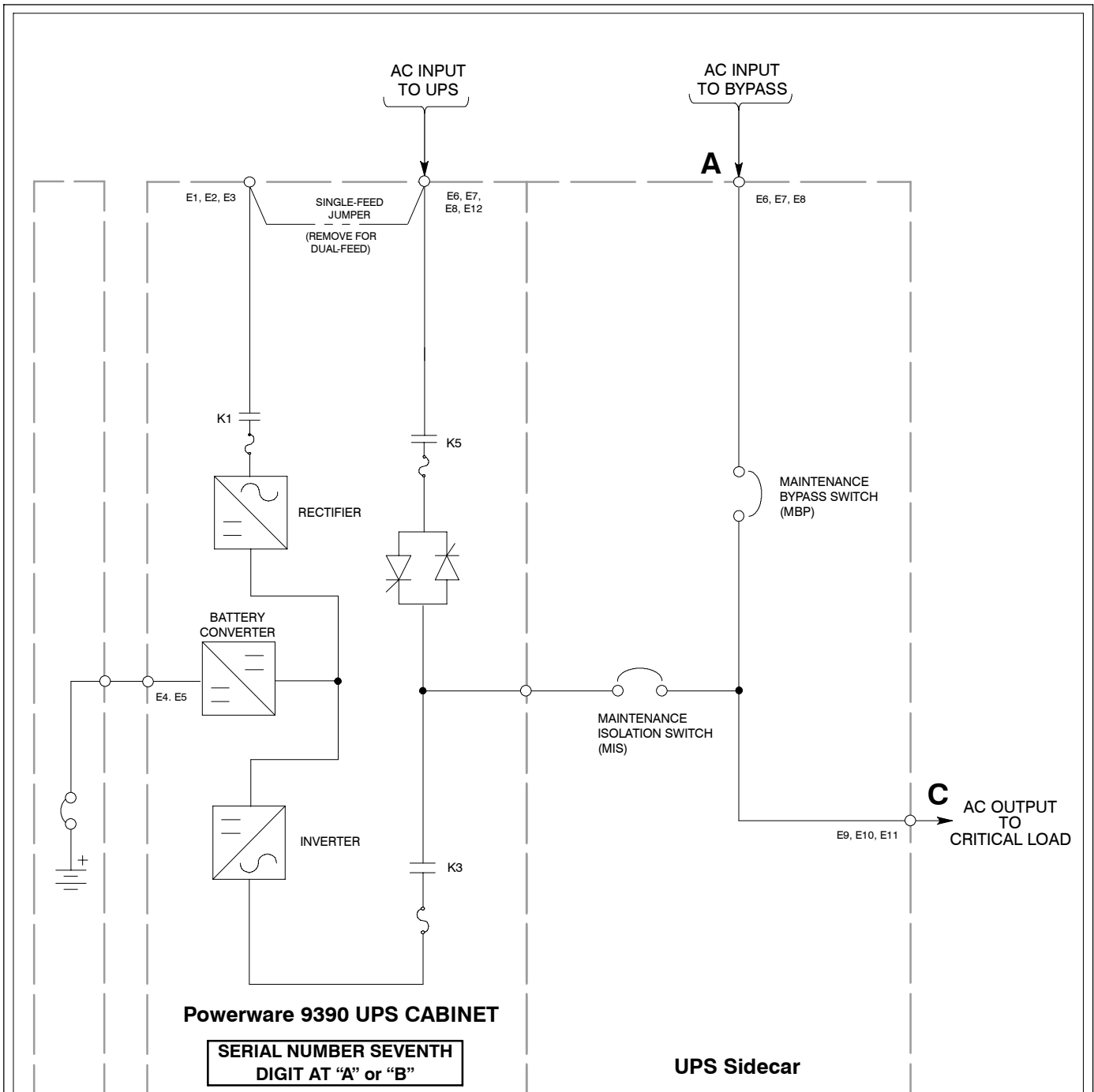

- NOTE**
1. A minimum of two separate feeds with upstream feeder breakers, or one feed with two upstream feeder breakers, must be provided: one for the UPS and one for the UPS Sidecar bypass input. DO NOT use one feed or a single feeder breaker to supply both the UPS and the UPS Sidecar.
 2. Remove jumper for dual-feed.
 3. If the load requires a neutral, a bypass neutral feeder must be supplied.

**MAINTENANCE BYPASS CONFIGURATION
80/40, 80/50, 80/60 AND 80/80 kVA,
208/208V AND 480/480V
WITH UPS SERIAL NUMBER SEVENTH DIGIT AT
"A" OR "B"**

DESCRIPTION: UPS SIDECAR ONLINE DRAWINGS	
DRAWING NO: 164201546-3	SHEET: 1 of 11
REVISION: C	DATE: 062806

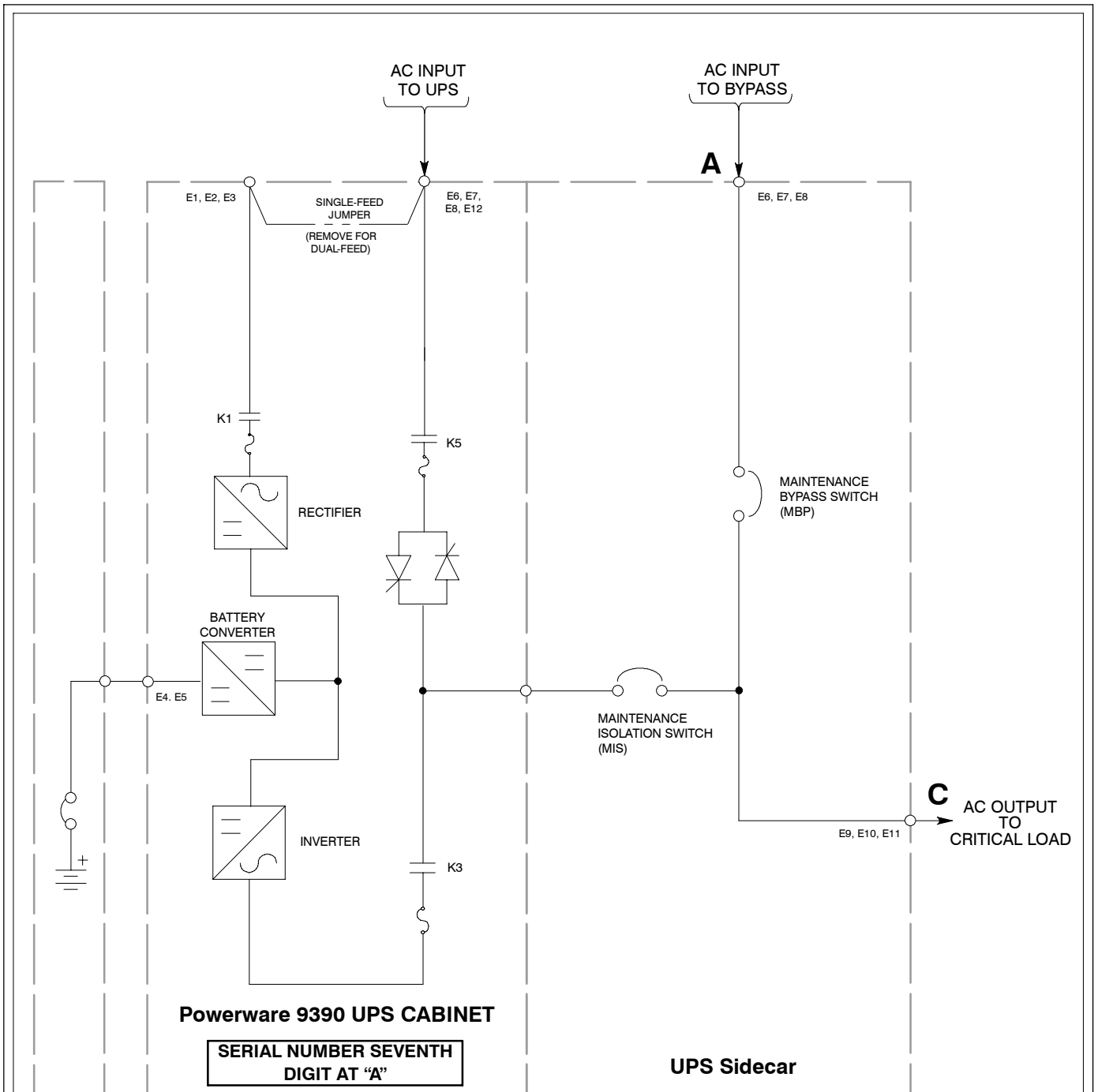

- NOTE**
1. A minimum of two separate feeds with upstream feeder breakers, or one feed with two upstream feeder breakers, must be provided: one for the UPS and one for the UPS Sidecar bypass input. DO NOT use one feed or a single feeder breaker to supply both the UPS and the UPS Sidecar.
 2. Remove jumper for dual-feed.
 3. If the load requires a neutral, a bypass neutral feeder must be supplied.

**MAINTENANCE BYPASS CONFIGURATION
120/100 AND 120/120 kVA, 480/480V
160/100, 160/120, AND 160/160 kVA, 480/480V
WITH UPS SERIAL NUMBER SEVENTH DIGIT AT "A"**

DESCRIPTION: UPS SIDECAR ONELINE DRAWINGS	
DRAWING NO.: 164201546-3	SHEET: 2 of 11
REVISION: B	DATE: 062806

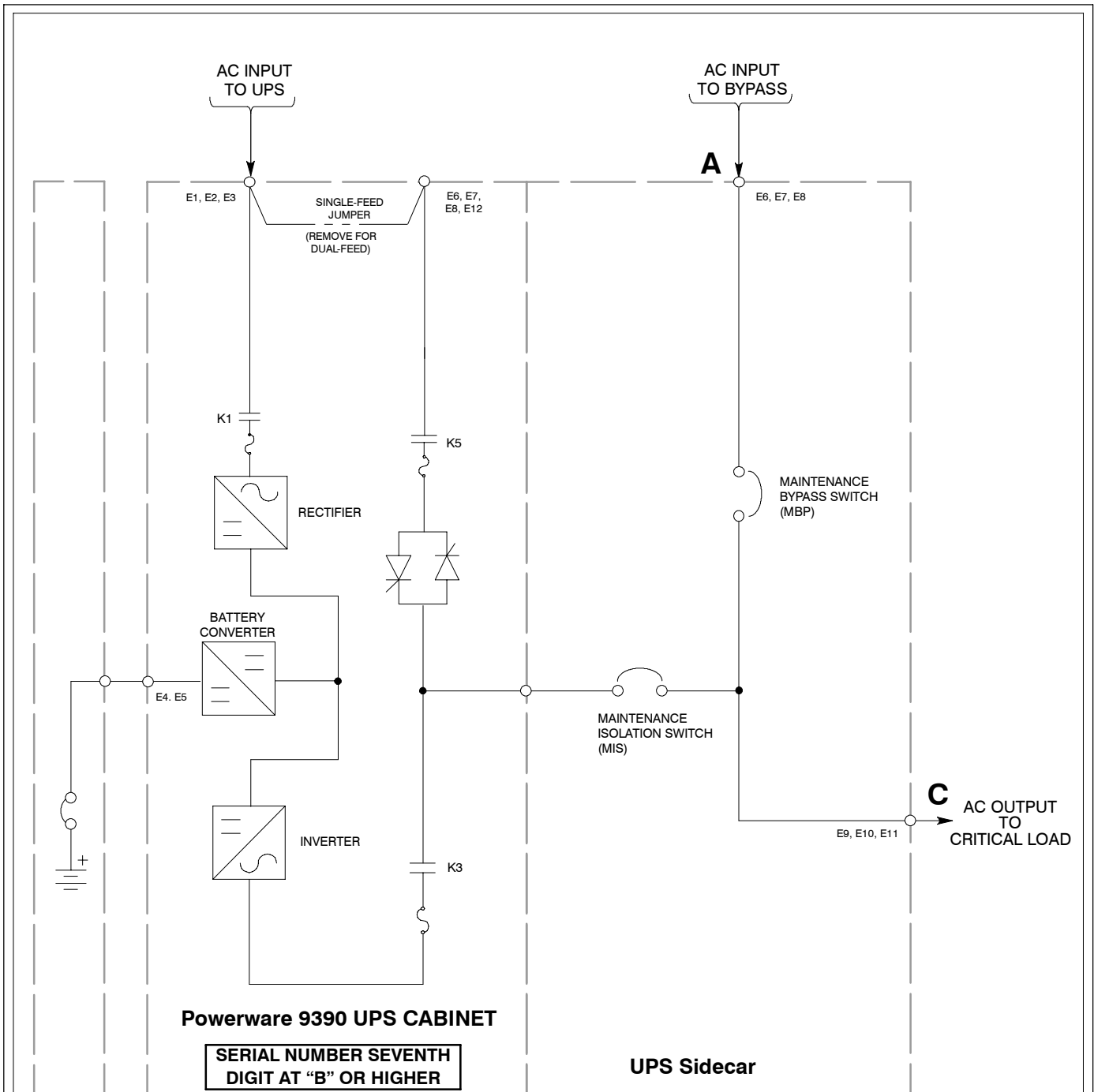

- NOTE**
1. A minimum of two separate feeds with upstream feeder breakers, or one feed with two upstream feeder breakers, must be provided: one for the UPS and one for the UPS Sidecar bypass input. DO NOT use one feed or a single feeder breaker to supply both the UPS and the UPS Sidecar.
 2. Remove jumper for dual-feed.
 3. If the load requires a neutral, a bypass neutral feeder must be supplied.

**MAINTENANCE BYPASS CONFIGURATION
120/100 AND 120/120 kVA, 480/480V
WITH UPS SERIAL NUMBER SEVENTH DIGIT
AT "B" OR HIGHER**

DESCRIPTION: UPS SIDECAR ONELINE DRAWINGS	
DRAWING NO: 164201546-3	SHEET: 3 of 11
REVISION: B	DATE: 062806

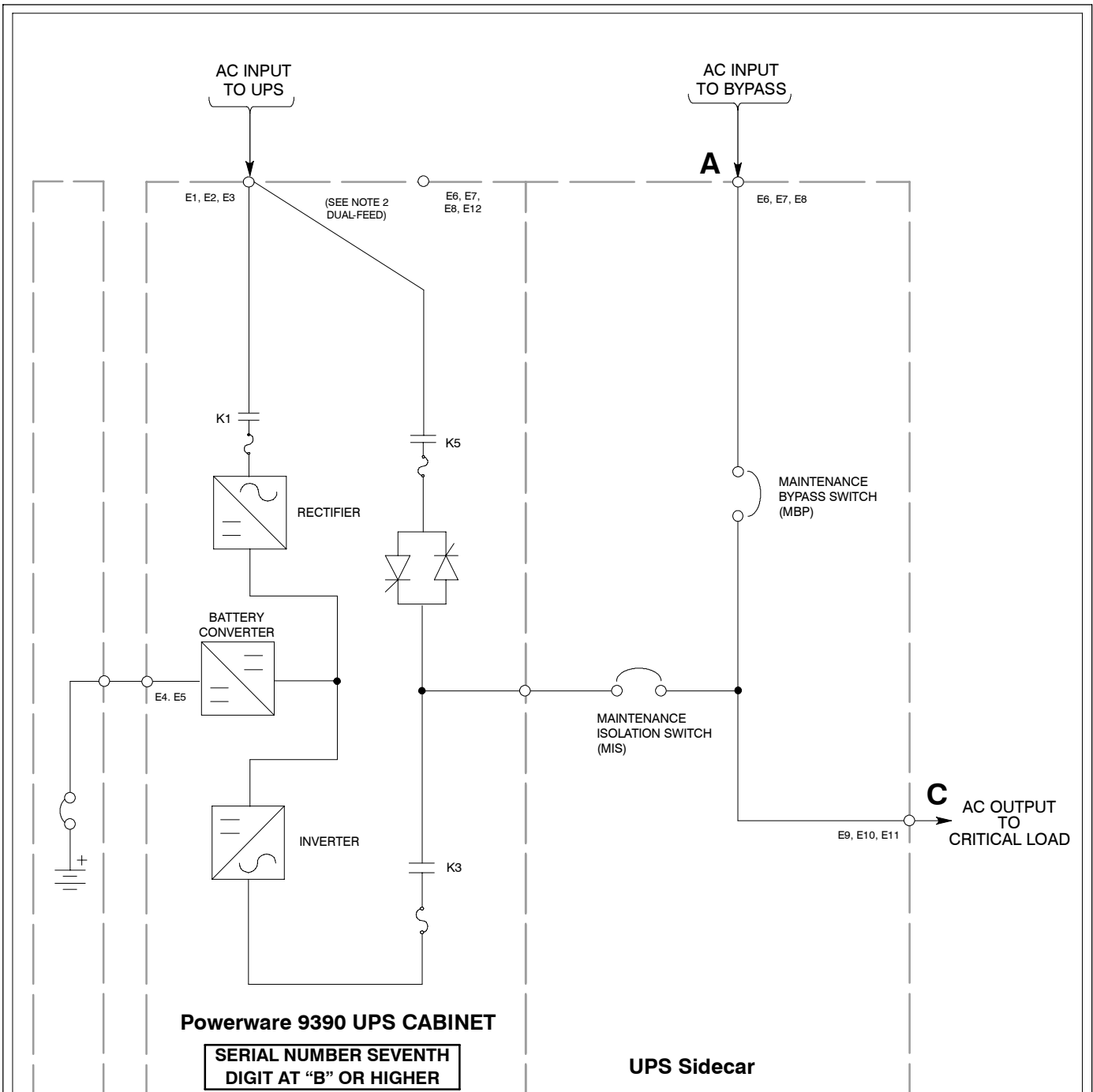

- NOTE**
1. A minimum of two separate feeds with upstream feeder breakers, or one feed with two upstream feeder breakers, must be provided: one for the UPS and one for the UPS Sidecar bypass input. DO NOT use one feed or a single feeder breaker to supply both the UPS and the UPS Sidecar.
 2. Move bypass contactor wires to bypass terminals for dual-feed.
 3. If the load requires a neutral, a bypass neutral feeder must be supplied.

**MAINTENANCE BYPASS CONFIGURATION
160/100, 160/120, AND 160/160 kVA, 480/480V
WITH UPS SERIAL NUMBER SEVENTH DIGIT
AT "B" OR HIGHER**

DESCRIPTION: UPS SIDECAR ONELINE DRAWINGS	
DRAWING NO.: 164201546-3	SHEET: 4 of 11
REVISION: B	DATE: 062806

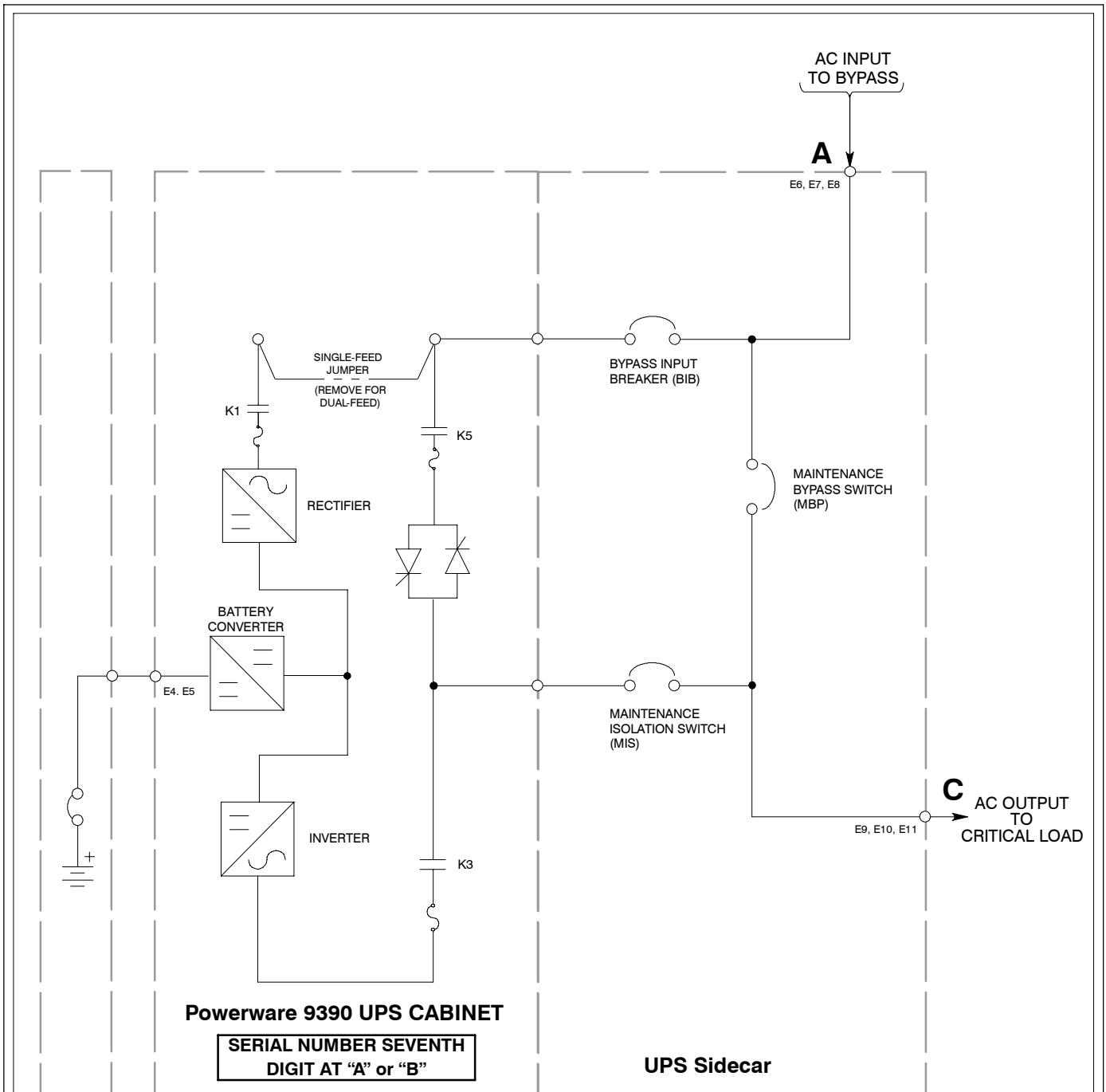

Powerware 9390 UPS CABINET

**SERIAL NUMBER SEVENTH
DIGIT AT "A" or "B"**

UPS Sidecar

**MAINTENANCE BYPASS WITH BIB CONFIGURATION
40/20, 40/30, 40/40, 80/40, 80/50, 80/60, AND 80/80 kVA,
208/208V AND 480/480V
WITH UPS SERIAL NUMBER SEVENTH DIGIT AT "A" OR "B"**

NOTE 1. Remove jumper for dual-feed.
2. If the load requires a neutral, a bypass neutral feeder must be supplied.

DESCRIPTION: UPS SIDECAR ONELINE DRAWINGS	
DRAWING NO: 164201546-3	SHEET: 5 of 11
REVISION: B	DATE: 062806

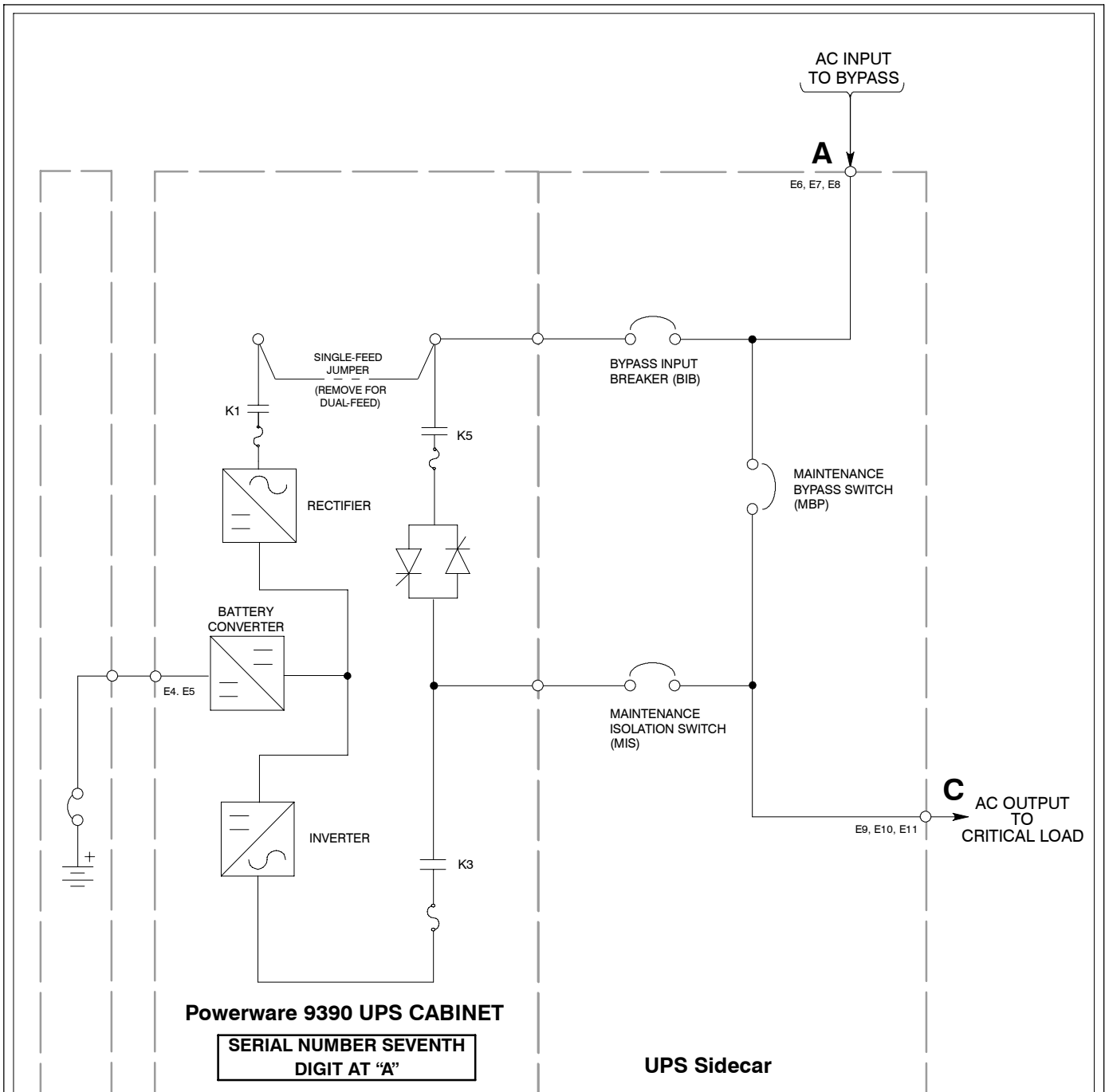

Powerware 9390 UPS CABINET

**SERIAL NUMBER SEVENTH
DIGIT AT "A"**

UPS Sidecar

**MAINTENANCE BYPASS WITH BIB CONFIGURATION
120/100 AND 120/120 kVA, 480/480V
160/100, 160/120, AND 160/160 kVA, 480/480V
WITH UPS SERIAL NUMBER SEVENTH DIGIT AT "A"**

NOTE 1. Remove jumper for dual-feed.
2. If the load requires a neutral, a bypass neutral feeder must be supplied.

DESCRIPTION: UPS SIDECAR ONELINE DRAWINGS	
DRAWING NO: 164201546-3	SHEET: 6 of 11
REVISION: B	DATE: 062806

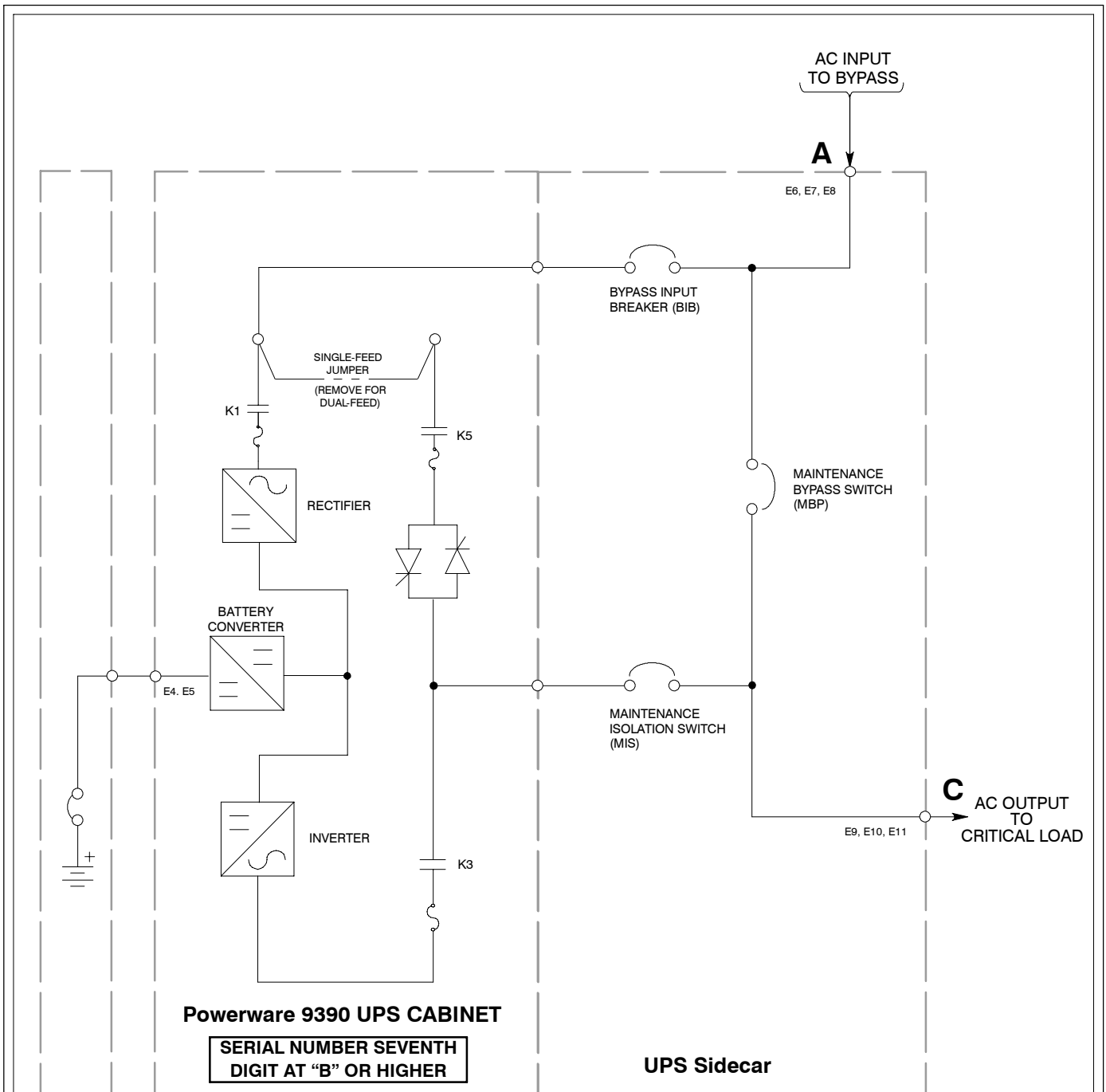

**MAINTENANCE BYPASS WITH BIB CONFIGURATION
 120/100 AND 120/120 kVA, 480/480V
 WITH UPS SERIAL NUMBER SEVENTH DIGIT AT "B" OR HIGHER**

NOTE 1. Remove jumper for dual-feed.
 2. If the load requires a neutral, a bypass neutral feeder must be supplied.

DESCRIPTION: UPS ONLINE ONLINE DRAWINGS	
DRAWING NO: 164201546-3	SHEET: 7 of 11
REVISION: B	DATE: 062806

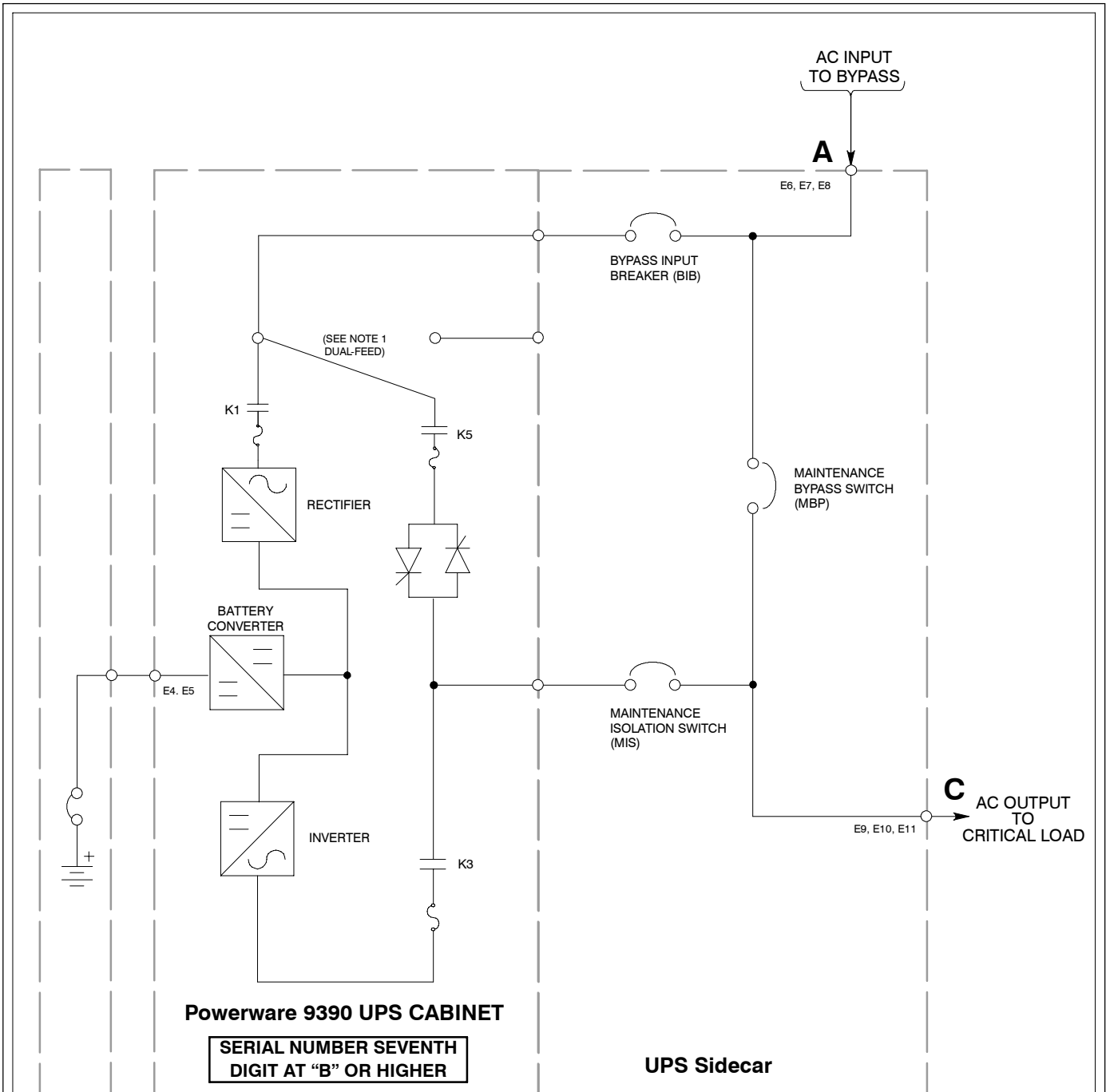

**MAINTENANCE BYPASS WITH BIB CONFIGURATION
 160/100, 160/120, and 160/160 kVA, 480/480V
 WITH UPS SERIAL NUMBER SEVENTH DIGIT AT "B" OR HIGHER**

NOTE 1. Move bypass contactor wires to bypass terminals for dual-feed.
 2. If the load requires a neutral, a bypass neutral feeder must be supplied.

DESCRIPTION: UPS SIDECAR ONLINE DRAWINGS	
DRAWING NO: 164201546-3	SHEET: 8 of 11
REVISION: B	DATE: 062806

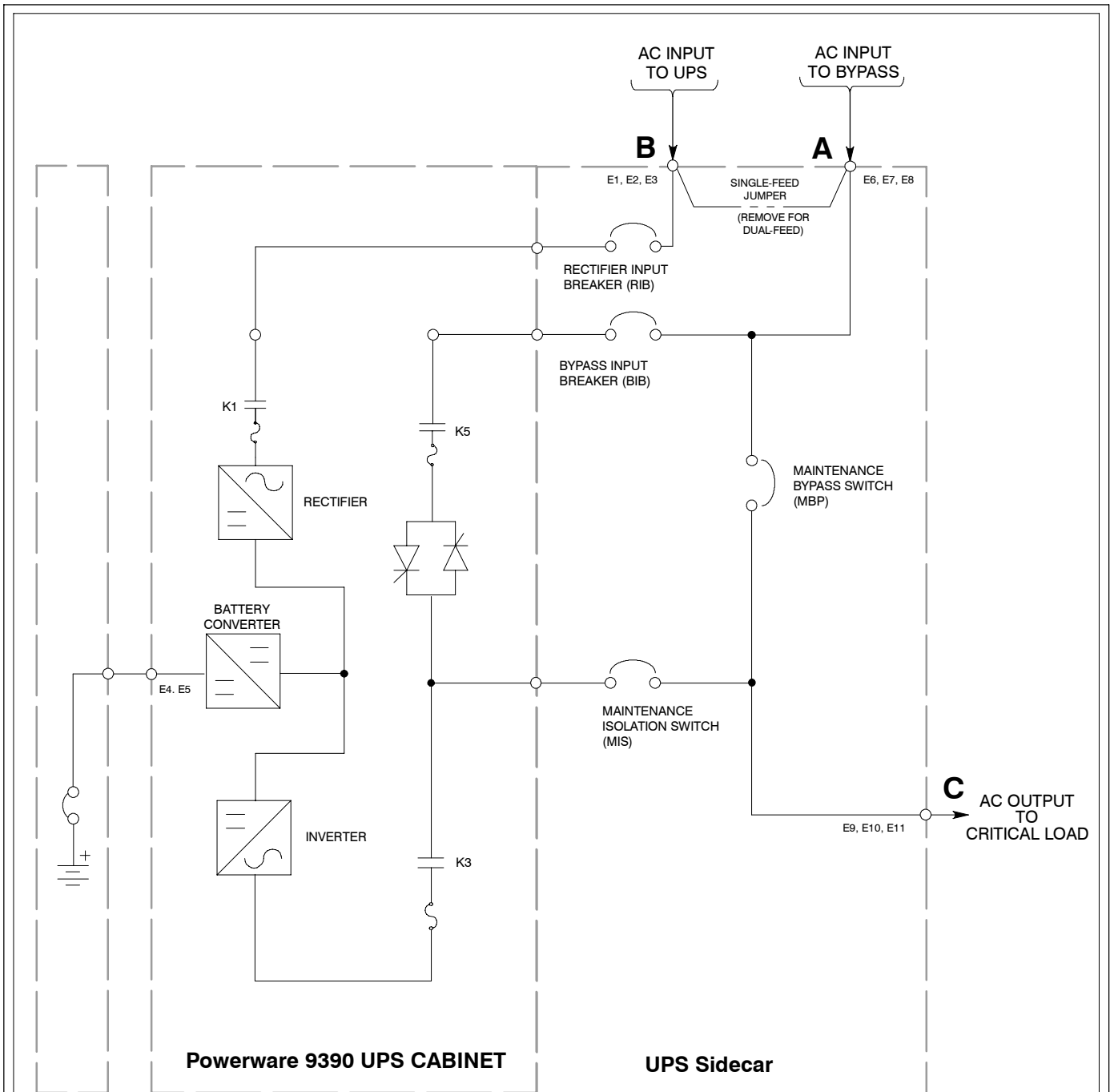

MAINTENANCE BYPASS WITH BIB AND RIB
40/20, 40/30, 40/40, 208/208V,
120/100, 120/120 kVA, 480/480V and
160/100, 160/120, 160/160 kVA, 480/480V

NOTE 1. Remove jumper for dual-feed.
 2. If the load requires a neutral, a bypass neutral feeder must be supplied.

DESCRIPTION: UPS SIDECAR ONELINE DRAWINGS	
DRAWING NO: 164201546-3	SHEET: 9 of 11
REVISION: C	DATE: 092107

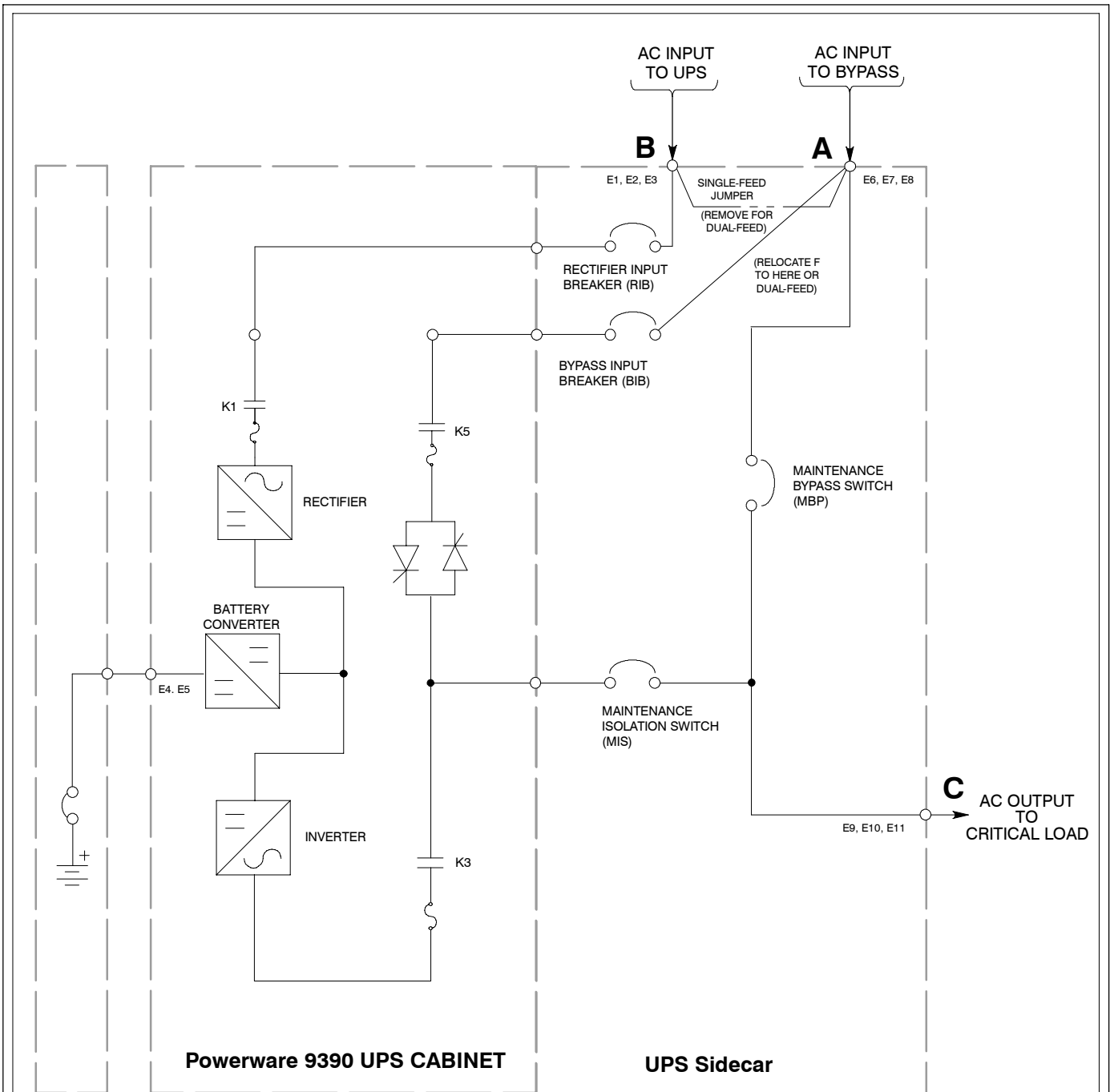

**MAINTENANCE BYPASS WITH BIB AND RIB
80/40, 80/50, 80/60, 80/80 kVA, 480/480V,**

- NOTE**
1. Remove jumper for dual-feed.
 2. For 80kVA 480/480V dual-feed, move BIB wires from E1, E2, E3 to E6, E7, E8.
 3. If the load requires a neutral, a bypass neutral feeder must be supplied.

DESCRIPTION: UPS SIDECAR ONLINE DRAWINGS	
DRAWING NO: 164201546-3	SHEET: 10 of 11
REVISION: C	DATE: 092107

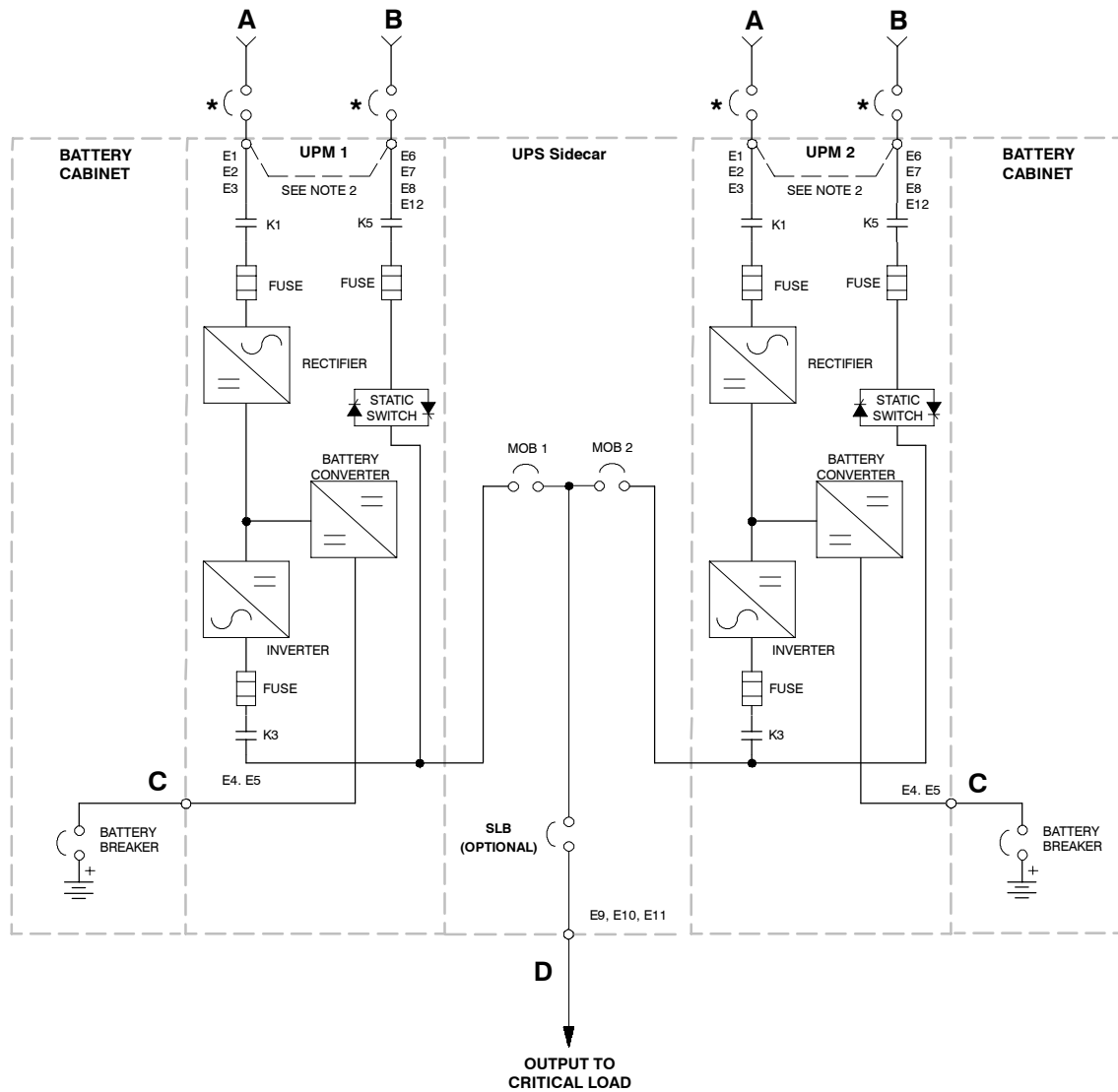

- A** – AC Input to UPS Rectifier (dual-feed)
- B** – AC Input to UPS Rectifier (single-feed) and Bypass (single- and dual-feed)
- C** – DC Input from Battery
- D** – Output to Critical Load
- * – Overcurrent Protection Provided by Others

TYPICAL PARALLEL REDUNDANT SYSTEM (1+1 CONFIGURATION)

NOTE 1. UPM and system bypass input feeds must come from the same source.
 2. Remove jumper for dual-feed.
 3. If the load requires a neutral, a bypass neutral feeder must be supplied.

DESCRIPTION: UPS SIDECAR ONLINE DRAWINGS	
DRAWING NO: 164201546-3	SHEET: 11 of 11
REVISION: A	DATE: 031505

Table B. INPUT/OUTPUT Ratings & External Wiring Requirements for Powerware 9390 UPS Sidecar (Maintenance Bypass) 208/208V								
		Units	Rating 50/60 Hz					
Basic Unit Rating		UPS kVA	20	30	40	50	60	80
Input and Bypass Input Output		VOLTS	208	208	208	208	208	208
		VOLTS	208	208	208	208	208	208
AC Input to Maintenance Bypass (without BIB or RIB, or dual feed with BIB and RIB) (3) Phases, (1) Neutral—if required, (1) Ground Minimum Conductor Size Number per Phase	A	AMPS	56	83	111	139	167	222
		AWG or kcmil (each)	2 (1)	2/0 (1)	2/0 (1)	4/0 (1)	250 (1)	2/0 (2)
AC Input to Maintenance Bypass (single feed with BIB, or single feed with BIB and RIB) (3) Phases, (1) Neutral—if required, (1) Ground Minimum Conductor Size Number per Phase	A	AMPS	60	90	125	155	185	240
		AWG or kcmil (each)	2 (1)	2/0 (1)	2/0 (1)	4/0 (1)	250 (1)	2/0 (2)
AC Input to Optional RIB (3) Phases, (1) Ground Minimum Conductor Size Number per Phase	B	AMPS	60	90	125	155	185	240
		AWG or kcmil (each)	2 (1)	2/0 (1)	2/0 (1)	4/0 (1)	250 (1)	2/0 (2)
AC Output to Critical Load Full Load Current (3) Phases, (1) Neutral—if required, (1) Ground Minimum Conductor Size Number per Phase	C	AMPS	56	83	111	139	167	222
		AWG or kcmil (each)	2 (1)	2/0 (1)	2/0 (1)	4/0 (1)	250 (1)	2/0 (2)

NOTE Callout letters **A**, **B**, and **C** map to drawing 164201546–3, sheets 1 of 11, 5 of 11, and 9 of 11.

DESCRIPTION: POWER WIRING INSTALLATION NOTES	
DRAWING NO: 164201546–4	SHEET: 1 of 10
REVISION: D	DATE: 092107

Table C. INPUT/OUTPUT Ratings & External Wiring Requirements for Powerware 9390 UPS Sidecar (Maintenance Bypass) 480/480V

		Units	Rating 50/60 Hz								
Basic Unit Rating		UPS kVA	20	30	40	50	60	80	100	120	160
Input and Bypass Input		VOLTS	480	480	480	480	480	480	480	480	480
Output		VOLTS	480	480	480	480	480	480	480	480	480
AC Input to Maintenance Bypass (without BIB or RIB, or dual feed with BIB and RIB) (3) Phases, (1) Neutral – if required, (1) Ground Minimum Conductor Size Number per Phase	A	AMPS	24	36	48	60	72	96	120	144	193
		AWG or kcmil (each)	6 (1)	4 (1)	4 (1)	2 (1)	1 (1)	1/0 (1)	4/0 (1)	4/0 (1)	1/0 (2)
AC Input to Maintenance Bypass (single feed with BIB, or single feed with BIB and RIB) (3) Phases, (1) Neutral – if required, (1) Ground Minimum Conductor Size Number per Phase	A	AMPS	30	40	55	67	80	105	130	160	210
		AWG or kcmil (each)	6 (1)	4 (1)	4 (1)	2 (1)	1 (1)	1/0 (1)	4/0 (1)	4/0 (1)	1/0 (2)
AC Input to Optional RIB (3) Phases, (1) Ground Minimum Conductor Size Number per Phase	B	AMPS	30	40	55	67	80	105	130	160	210
		AWG or kcmil (each)	6 (1)	4 (1)	4 (1)	2 (1)	1 (1)	1/0 (1)	4/0 (1)	4/0 (1)	1/0 (2)
AC Output to Critical Load Full Load Current (3) Phases, (1) Neutral – if required, (1) Ground Minimum Conductor Size Number per Phase	C	AMPS	24	36	48	60	72	96	120	144	193
		AWG or kcmil (each)	6 (1)	4 (1)	4 (1)	2 (1)	1 (1)	1/0 (1)	4/0 (1)	4/0 (1)	1/0 (2)

NOTE Callout letters **A, B, and C** map to drawing 164201546–3, sheets 1 of 11, 2 of 11, 3 of 11, 4 of 11, 5 of 11, 6 of 11, 7 of 11, 8 of 11, and 9 of 11.

DESCRIPTION: POWER WIRING INSTALLATION NOTES	
DRAWING NO: 164201546–4	SHEET: 2 of 10
REVISION: D	DATE: 061507

Table D. INPUT/OUTPUT Ratings & External Wiring Requirements for Powerware 9390 UPS Sidecar (1 + 1 Parallel Redundant) 208V

		Units	Rating 50/60 Hz			
Basic Unit Rating		UPS kVA	40	50	60	80
Input and Bypass Input Output		VOLTS VOLTS	208 208	208 208	208 208	208 208
AC Input from UPM Full Load Current for each Module (3) Phases, (1) Neutral—if required, (1) Ground Minimum Conductor Size for each Module Number per Phase for each Module	—	AMPS	111	139	167	222
		For customer-supplied wiring in a standalone installation, refer to the applicable Powerware 9390 installation and operation manual, listed in paragraph 1.5, for wire size. Wiring for line-up-and-match installation is factory-supplied.				
AC Output to Critical Load Full Load Current (3) Phases, (1) Neutral—if required, (1) Ground Minimum Conductor Size Number per Phase	D	AMPS	111	139	167	222
		AWG or kcmil (each)	2/0 (1)	4/0 (1)	250 (1)	2/0 (2)

NOTE Callout letter **D** maps to drawing 164201546–3, sheet 11 of 11.

Table E. INPUT/OUTPUT Ratings & External Wiring Requirements for Powerware 9390 UPS Sidecar (1 + 1 Parallel Redundant) 480V

		Units	Rating 50/60 Hz								
Basic Unit Rating		UPS kVA	20 (See Note 2)	30 (See Note 2)	40	50	60	80	100	120	160
Input and Bypass Input Output		VOLTS VOLTS	480 480	480 480	480 480	480 480	480 480	480 480	480 480	480 480	480 480
AC Input from UPM Full Load Current for each Module (3) Phases, (1) Neutral—if required, (1) Ground Minimum Conductor Size for each Module Number per Phase for each Module	—	AMPS	48	48	48	60	72	96	120	144	192
		For customer-supplied wiring in a standalone installation, refer to the applicable Powerware 9390 installation and operation manual, listed in paragraph 1.5, for wire size. Wiring for line-up-and-match installation is factory-supplied.									
AC Output to Critical Load Full Load Current (3) Phases, (1) Neutral—if required, (1) Ground Minimum Conductor Size Number per Phase	D	AMPS	48	48	48	60	72	96	120	144	192
		AWG or kcmil (each)	4 (1)	4 (1)	4 (1)	2 (1)	1 (1)	1/0 (1)	4/0 (1)	4/0 (1)	1/0 (2)

NOTE 1. Callout letter **D** maps to drawing 164201546–3, sheet 11 of 11.

NOTE 2. 40/20 kVA and 40/30 kVA parallel systems must be wired same as a 40/40 kVA.

DESCRIPTION: POWER WIRING INSTALLATION NOTES	
DRAWING NO: 164201546–4	SHEET: 3 of 10
REVISION: D	DATE: 092107

Read and understand the following notes while planning and performing the installation:

1. Refer to national and local electrical codes for acceptable external wiring practices.
2. Material and labor for external wiring requirements are to be provided by designated personnel.

CAUTION



Specified wiring and the MOB and SLB breakers for the UPS Sidecar are rated for parallel redundant service only. DO NOT use as a parallel capacity system.

CAUTION



Parallel system wiring length should be in accordance with the parallel drawings found in the appendix of the applicable Powerware 9390 installation and operation manual, listed in paragraph 1.5. Correct wire length ensures approximate equal current sharing when in Static bypass mode.

3. For external input wiring, use 90°C copper wire. See the appropriate column in Table B through Table E. Wire sizes are based on using the specified breakers.
4. Wire ampacities are chosen from Table 310–16 of the NEC. Input wire is 90°C specification.
5. If a Bypass Input Breaker is not installed, a minimum of two separate feeds with upstream feeder breakers, or one feed with two upstream feeder breakers, must be provided: one for the UPS and one for the UPS Sidecar bypass input. DO NOT use one feed or a single-feeder breaker to supply both the UPS and Sidecar.
6. Refer to Section I of this manual for installation instructions.
7. Refer to the applicable Powerware 9390 installation and operation manual, listed in paragraph 1.5, for UPS cabinet wiring requirements, and conduit and terminal locations.
8. Refer to the applicable Powerware 9390 installation and operation manual, listed in paragraph 1.5, for parallel system power and control wiring requirements.
9. Terminals are UL and CSA rated at 90°C. Refer to Table F through Table K for power cable terminations. Drawing 164201546–6, starting on page A–30, shows the location of the power cable terminals inside the UPS Sidecar cabinet.
10. Per NEC article 300-20(a), all three-phase conductors must be run in the same conduit. Neutral and ground must be run in the same conduit as the phase conductors.
11. If input or output neutrals are required for Maintenance Bypass configurations, wire the neutrals to the neutral terminals located inside the UPS cabinet. For Maintenance Bypass configurations, wire grounds to the ground terminals located inside the UPS cabinet.
12. 40/20 kVA and 40/30 kVA parallel systems must be wired for 40/40 kVA.

<i>DESCRIPTION:</i> POWER WIRING INSTALLATION NOTES	
<i>DRAWING NO:</i> 164201546–4	<i>SHEET:</i> 4 of 10
<i>REVISION:</i> C	<i>DATE:</i> 061507

Table F. UPS Sidecar Maintenance Bypass Power Cable Terminations 40/20, 40/30, 40/40, 480/480V				
<i>Terminal Function</i>	<i>Function</i>	<i>Size of Pressure Termination</i>	<i>Tightening Torque Nm (lb in)</i>	<i>Type Screw</i>
AC Input to Maintenance Bypass or Optional BIB	Phase A	1 – #14–2/0	13.5 (120)	3/16" Hex
	Phase B	1 – #14–2/0	13.5 (120)	3/16" Hex
	Phase C	1 – #14–2/0	13.5 (120)	3/16" Hex
AC Input to Optional RIB	Phase A	1 – #14–3/0	5.6 (50)	Slot
	Phase B	1 – #14–3/0	5.6 (50)	Slot
	Phase C	1 – #14–3/0	5.6 (50)	Slot
AC Output to Critical Load	Phase A	1 – #14–2/0	13.5 (120)	3/16" Hex
	Phase B	1 – #14–2/0	13.5 (120)	3/16" Hex
	Phase C	1 – #14–2/0	13.5 (120)	3/16" Hex

Table G. UPS Sidecar Maintenance Bypass Power Cable Terminations 40/20, 40/30, 40/40, 208/208V and 80/40, 80/50, 80/60, 80/80, 480/480V				
<i>Terminal Function</i>	<i>Function</i>	<i>Size of Pressure Termination</i>	<i>Tightening Torque Nm (lb in)</i>	<i>Type Screw</i>
AC Input to Maintenance Bypass	Phase A	1 – #4–350 kcmil	20.0 (177)	M4 Hex
	Phase B	1 – #4–350 kcmil	20.0 (177)	M4 Hex
	Phase C	1 – #4–350 kcmil	20.0 (177)	M4 Hex
Bypass Input with Optional BIB (Terminal Block)	Phase A	1 – #14–2/0	13.5 (120)	3/16" Hex
	Phase B	1 – #14–2/0	13.5 (120)	3/16" Hex
	Phase C	1 – #14–2/0	13.5 (120)	3/16" Hex
Rectifier Input with Optional RIB (Terminal Block)	Phase A	1 – #14–2/0	13.5 (120)	3/16" Hex
	Phase B	1 – #14–2/0	13.5 (120)	3/16" Hex
	Phase C	1 – #14–2/0	13.5 (120)	3/16" Hex
AC Output to Critical Load	Phase A	1 – #14–2/0	13.5 (120)	3/16" Hex
	Phase B	1 – #14–2/0	13.5 (120)	3/16" Hex
	Phase C	1 – #14–2/0	13.5 (120)	3/16" Hex

Table H. UPS Sidecar Maintenance Bypass Power Cable Terminations 120/100, 120/120, 480/480V				
<i>Terminal Function</i>	<i>Function</i>	<i>Size of Pressure Termination</i>	<i>Tightening Torque Nm (lb in)</i>	<i>Type Screw</i>
Bypass Input with Optional BIB (Terminal Block)	Phase A	1 – #6–500 kcmil	56.5 (500)	1/2" Hex
	Phase B	1 – #6–500 kcmil	56.5 (500)	1/2" Hex
	Phase C	1 – #6–500 kcmil	56.5 (500)	1/2" Hex
Rectifier Input with Optional RIB (Terminal Block)	Phase A	1 – #6–500 kcmil	56.5 (500)	1/2" Hex
	Phase B	1 – #6–500 kcmil	56.5 (500)	1/2" Hex
	Phase C	1 – #6–500 kcmil	56.5 (500)	1/2" Hex
AC Input to Maintenance Bypass	Phase A	1 – #4–350 kcmil	20.0 (177)	M4 Hex
	Phase B	1 – #4–350 kcmil	20.0 (177)	M4 Hex
	Phase C	1 – #4–350 kcmil	20.0 (177)	M4 Hex
AC Output to Critical Load (Terminal Block)	Phase A	1 – #6–500 kcmil	56.5 (500)	1/2" Hex
	Phase B	1 – #6–500 kcmil	56.5 (500)	1/2" Hex
	Phase C	1 – #6–500 kcmil	56.5 (500)	1/2" Hex

DESCRIPTION: POWER WIRING INSTALLATION NOTES	
DRAWING NO: 164201546–4	SHEET: 5 of 10
REVISION: D	DATE: 092107

Table I. UPS Sidecar Maintenance Bypass Power Cable Terminations 80/40, 80/50, 80/60, 80/80, 208/208V and 160/100, 160/120, 160/160, 480/480V				
<i>Terminal Function</i>	<i>Function</i>	<i>Size of Pressure Termination</i>	<i>Tightening Torque Nm (lb in)</i>	<i>Type Screw</i>
AC Input to Maintenance Bypass or Optional BIB	Phase A	1 – 2/0–250 kcmil 1 – 2/0–500 kcmil	31.1 (275) 31.1 (275)	5/16" Hex 3/8" Hex
	Phase B	1 – 2/0–250 kcmil 1 – 2/0–500 kcmil	31.1 (275) 31.1 (275)	5/16" Hex 3/8" Hex
	Phase C	1 – 2/0–250 kcmil 1 – 2/0–500 kcmil	31.1 (275) 31.1 (275)	5/16" Hex 3/8" Hex
AC Input to Optional RIB	Phase A	1 – 2/0–250 kcmil 1 – 2/0–500 kcmil	31.1 (275) 31.1 (275)	5/16" Hex 3/8" Hex
	Phase B	1 – 2/0–250 kcmil 1 – 2/0–500 kcmil	31.1 (275) 31.1 (275)	5/16" Hex 3/8" Hex
	Phase C	1 – 2/0–250 kcmil 1 – 2/0–500 kcmil	31.1 (275) 31.1 (275)	5/16" Hex 3/8" Hex
AC Output to Critical Load	Phase A	1 – 2/0–250 kcmil 1 – 2/0–500 kcmil	31.1 (275) 31.1 (275)	5/16" Hex 3/8" Hex
	Phase B	1 – 2/0–250 kcmil 1 – 2/0–500 kcmil	31.1 (275) 31.1 (275)	5/16" Hex 3/8" Hex
	Phase C	1 – 2/0–250 kcmil 1 – 2/0–500 kcmil	31.1 (275) 31.1 (275)	5/16" Hex 3/8" Hex

Table J. UPS Sidecar 1+1 Parallel Redundant Power Cable Terminations 40/20, 40/30, 40/40, 208/208V and 80/40, 80/50, 80/60, 80/80, 480/480V				
<i>Terminal Function</i>	<i>Function</i>	<i>Size of Pressure Termination</i>	<i>Tightening Torque Nm (lb in)</i>	<i>Type Screw</i>
AC Input from UPM2 to MOB 2 (standalone installation)	Phase A	1 – #4–350 kcmil	20.3 (180)	3/16" Hex
	Phase B	1 – #4–350 kcmil	20.3 (180)	3/16" Hex
	Phase C	1 – #4–350 kcmil	20.3 (180)	3/16" Hex
AC Output to Critical Load (without SLB) Terminal Block	Phase A	1 – #14–2/0	13.5 (120)	3/16" Hex
	Phase B	1 – #14–2/0	13.5 (120)	3/16" Hex
	Phase C	1 – #14–2/0	13.5 (120)	3/16" Hex
AC Output to Critical Load (with SLB)	Phase A	1 – #4–350 kcmil	20.3 (180)	3/16" Hex
	Phase B	1 – #4–350 kcmil	20.3 (180)	3/16" Hex
	Phase C	1 – #4–350 kcmil	20.3 (180)	3/16" Hex
Neutral (80/480)	Neutral	4 – #14–1/0	5.6 (50)	Slotted
Neutral (40/208)	Neutral	8 – #6–250 kcmil	42.4 (375)	5/16" Hex
Ground	Ground	2 – #14–1/0	5.6 (50)	Slotted

DESCRIPTION: POWER WIRING INSTALLATION NOTES	
DRAWING NO: 164201546–4	SHEET: 6 of 10
REVISION: D	DATE: 092107

Table K. UPS Sidecar 1+1 Parallel Redundant Power Cable Terminations 120/100, 120/120 kVA 480/480V				
<i>Terminal Function</i>	<i>Function</i>	<i>Size of Pressure Termination</i>	<i>Tightening Torque Nm (lb in)</i>	<i>Type Screw</i>
AC Input from UPM2 to MOB 2 (standalone installation)	Phase A	1 – #4–350 kcmil	20.3 (180)	3/16" Hex
	Phase B	1 – #4–350 kcmil	20.3 (180)	3/16" Hex
	Phase C	1 – #4–350 kcmil	20.3 (180)	3/16" Hex
AC Output to Critical Load (without SLB)	Phase A	1 – #6–500 kcmil	56.5 (500)	1/2 Hex
	Phase B	1 – #6–500 kcmil	56.5 (500)	1/2 Hex
	Phase C	1 – #6–500 kcmil	56.5 (500)	1/2 Hex
AC Output to Critical Load (with SLB)	Phase A	1 – #4–350 kcmil	20.3 (180)	3/16" Hex
	Phase B	1 – #4–350 kcmil	20.3 (180)	3/16" Hex
	Phase C	1 – #4–350 kcmil	20.3 (180)	3/16" Hex
Neutral	Neutral	8 – #6–250 kcmil	42.4 (375)	5/16" Hex
Ground	Ground	4 – #14–1/0	5.6 (50)	Slotted

Table L. UPS Sidecar 1+1 Parallel Redundant Power Cable Terminations 80/40, 80/50, 80/60, 80/80 kVA 208/208V				
<i>Terminal Function</i>	<i>Function</i>	<i>Size of Pressure Termination</i>	<i>Tightening Torque Nm (lb in)</i>	<i>Type Screw</i>
AC Input from UPM2 to MOB 2 (standalone installation)	Phase A	1 – 2/0–250 kcmil	31.1 (275)	5/16" Hex
		1 – 2/0–500 kcmil	31.1 (275)	3/8" Hex
	Phase B	1 – 2/0–250 kcmil	31.1 (275)	5/16" Hex
		1 – 2/0–500 kcmil	31.1 (275)	3/8" Hex
	Phase C	1 – 2/0–250 kcmil	31.1 (275)	5/16" Hex
		1 – 2/0–500 kcmil	31.1 (275)	3/8" Hex
AC Output to Critical Load (without SLB)	Phase A	1 – 2/0–250 kcmil	31.1 (275)	5/16" Hex
		1 – 2/0–500 kcmil	31.1 (275)	3/8" Hex
	Phase B	1 – 2/0–250 kcmil	31.1 (275)	5/16" Hex
		1 – 2/0–500 kcmil	31.1 (275)	3/8" Hex
	Phase C	1 – 2/0–250 kcmil	31.1 (275)	5/16" Hex
		1 – 2/0–500 kcmil	31.1 (275)	3/8" Hex
AC Output to Critical Load (with SLB)	Phase A	1 – 2/0–250 kcmil	31.1 (275)	5/16" Hex
		1 – 2/0–500 kcmil	31.1 (275)	3/8" Hex
	Phase B	1 – 2/0–250 kcmil	31.1 (275)	5/16" Hex
		1 – 2/0–500 kcmil	31.1 (275)	3/8" Hex
	Phase C	1 – 2/0–250 kcmil	31.1 (275)	5/16" Hex
		1 – 2/0–500 kcmil	31.1 (275)	3/8" Hex
Neutral	Neutral	8 – #6–250 kcmil	42.4 (375)	5/16" Hex
Ground	Ground	4 – #14–1/0	5.6 (50)	Slotted

13. Conduit is to be sized to accommodate one neutral conductor the same size as the phase conductor and one #8 AWG ground conductor. If two neutral conductors or an oversized neutral conductor are to be installed, size the conduit to accommodate the extra wire or size. All Powerware 9390 products can accommodate a double-sized neutral.
14. External UPS Sidecar rectifier and bypass input overcurrent protection is not provided by this product, but is required by codes. Refer to Table B through Table E for wiring requirements.

DESCRIPTION: POWER WIRING INSTALLATION NOTES	
DRAWING NO: 164201546–4	SHEET: 7 of 10
REVISION: E	DATE: 092107

Table M. UPS Sidecar 1+1 Parallel Redundant Power Cable Terminations 160/100, 160/120, 160/160 kVA 480/480V				
<i>Terminal Function</i>	<i>Function</i>	<i>Size of Pressure Termination</i>	<i>Tightening Torque Nm (lb in)</i>	<i>Type Screw</i>
AC Input from UPM2 to MOB 2 (standalone installation)	Phase A	1 – 2/0–250 kcmil 1 – 2/0–500 kcmil	31.1 (275) 31.1 (275)	5/16" Hex 3/8" Hex
	Phase B	1 – 2/0–250 kcmil 1 – 2/0–500 kcmil	31.1 (275) 31.1 (275)	5/16" Hex 3/8" Hex
	Phase C	1 – 2/0–250 kcmil 1 – 2/0–500 kcmil	31.1 (275) 31.1 (275)	5/16" Hex 3/8" Hex
AC Output to Critical Load (without SLB)	Phase A	1 – 2/0–250 kcmil 1 – 2/0–500 kcmil	31.1 (275) 31.1 (275)	5/16" Hex 3/8" Hex
	Phase B	1 – 2/0–250 kcmil 1 – 2/0–500 kcmil	31.1 (275) 31.1 (275)	5/16" Hex 3/8" Hex
	Phase C	1 – 2/0–250 kcmil 1 – 2/0–500 kcmil	31.1 (275) 31.1 (275)	5/16" Hex 3/8" Hex
AC Output to Critical Load (with SLB)	Phase A	1 – 2/0–250 kcmil 1 – 2/0–500 kcmil	31.1 (275) 31.1 (275)	5/16" Hex 3/8" Hex
	Phase B	1 – 2/0–250 kcmil 1 – 2/0–500 kcmil	31.1 (275) 31.1 (275)	5/16" Hex 3/8" Hex
	Phase C	1 – 2/0–250 kcmil 1 – 2/0–500 kcmil	31.1 (275) 31.1 (275)	5/16" Hex 3/8" Hex
Neutral	Neutral	8 – #6–250 kcmil	42.4 (375)	5/16" Hex
Ground	Ground	4 – #14–1/0	5.6 (50)	Slotted

Table N. UPS Sidecar 1+1 Parallel Redundant Power Cable Terminations 40/20, 40/30, 40/40 kVA 480/480V				
<i>Terminal Function</i>	<i>Function</i>	<i>Size of Pressure Termination</i>	<i>Tightening Torque Nm (lb in)</i>	<i>Type Screw</i>
AC Input from UPM2 to MOB 2 (standalone installation)	Phase A	1 – #14–3/0	5.6 (50)	Slotted
	Phase B	1 – #14–3/0	5.6 (50)	Slotted
	Phase C	1 – #14–3/0	5.6 (50)	Slotted
AC Output to Critical Load (without SLB) Terminal Block	Phase A	1 – #14–2/0	13.5 (120)	3/16" Hex
	Phase B	1 – #14–2/0	13.5 (120)	3/16" Hex
	Phase C	1 – #14–2/0	13.5 (120)	3/16" Hex
AC Output to Critical Load (with SLB)	Phase A	1 – #14–3/0	5.6 (50)	Slotted
	Phase B	1 – #14–3/0	5.6 (50)	Slotted
	Phase C	1 – #14–3/0	5.6 (50)	Slotted
Neutral	Neutral	4 – #14–1/0	5.6(50)	Slotted
Ground	Ground	2 – #14–1/0	5.6 (50)	Slotted

DESCRIPTION: POWER WIRING INSTALLATION NOTES	
DRAWING NO: 164201546–4	SHEET: 8 of 10
REVISION: E	DATE: 092107

15. Table O lists the maximum rating for rectifier input circuit breakers and Table P lists the maximum rating for bypass input circuit breakers.

<i>UPS Sidecar Model</i>	<i>Input Voltage Rating</i>		
		208V	480V
40 kVA	80% Rated	175A	70A
	100% Rated	150A	60A
50 kVA	80% Rated	225A	100A
	100% Rated	175A	80A
60 kVA	80% Rated	250A	125A
	100% Rated	200A	90A
80 kVA	80% Rated	350A	150A
	100% Rated	300A	125A
100 kVA	80% Rated	N/A	200A
	100% Rated	N/A	150A
120 kVA	80% Rated	N/A	225A
	100% Rated	N/A	175A
160 kVA	80% Rated	N/A	300A
	100% Rated	N/A	250A

<i>UPS Sidecar Model</i>	<i>Input Voltage Rating</i>		
		208V	480V
40 kVA	80% Rated	175A	70A
	100% Rated	150A	60A
50 kVA	80% Rated	225A	100A
	100% Rated	175A	80A
60 kVA	80% Rated	250A	125A
	100% Rated	200A	90A
80 kVA	80% Rated	350A	150A
	100% Rated	300A	125A
100 kVA	80% Rated	N/A	200A
	100% Rated	N/A	150A
120 kVA	80% Rated	N/A	225A
	100% Rated	N/A	175A
160 kVA	80% Rated	N/A	300A
	100% Rated	N/A	250A

CAUTION



To reduce the risk of fire, connect only to a circuit provided with maximum input circuit breaker current ratings from Table O in accordance with the NEC, ANSI/NFPA 70.

<i>DESCRIPTION:</i> POWER WIRING INSTALLATION NOTES		
<i>DRAWING NO:</i>	164201546-4	<i>SHEET:</i> 9 of 10
<i>REVISION:</i>	C	<i>DATE:</i> 062206

- 16. The MIS and SLB breakers on the 80 kVA, 120 kVA, and 160 kVA UPS Sidecars are adjustable trip breakers and are set to maximum at the factory. During installation these breakers must be adjusted for the site requirements using the dial on each breaker. The MIS and SLB breakers on the 40 kVA UPS Sidecar are non-adjustable.
- 17. The continuous current (I_r) values for the corresponding lettered adjustment setting marked on the MIS and SLB breakers are listed in Table Q.

Table Q. MIS and SLB Continuous Current (I_r) Settings

Breaker Setting	80 kVA Continuous Current (I _r)		120 kVA Continuous Current (I _r)		160 kVA Continuous Current (I _r)	
	208V	480V	208V	480V	208V	480V
A	250	100	N/A	100	N/A	250
B	300	125	N/A	125	N/A	300
C	350	150	N/A	150	N/A	350
D	400	160	N/A	160	N/A	400
E	—	175	N/A	175	N/A	—
F	—	200	N/A	200	N/A	—
G	—	225	N/A	225	N/A	—
H	—	250	N/A	250	N/A	—

DESCRIPTION: POWER WIRING INSTALLATION NOTES	
DRAWING NO: 164201546-4	SHEET: 10 of 10
REVISION: B	DATE: 063006

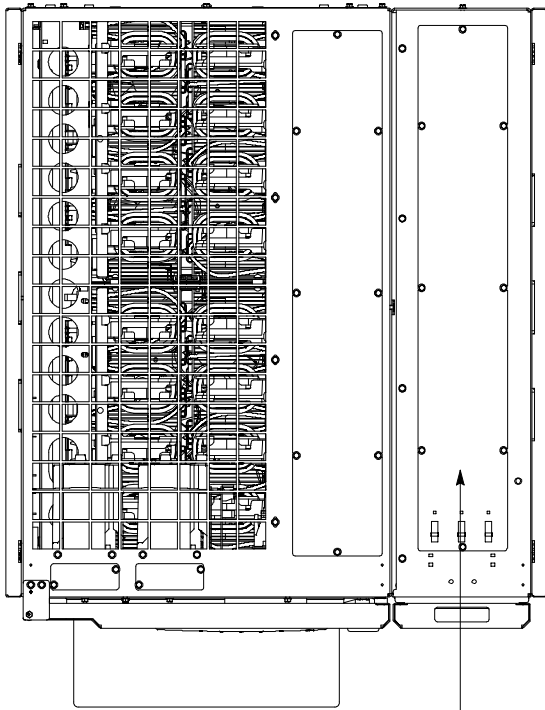

UPS SIDECAR TOP ENTRY
CONDUIT LANDING FOR AC
INPUT AND OUTPUT.
(REMOVE PANEL TO DRILL OR
PUNCH CONDUIT HOLES.)

TOP VIEW

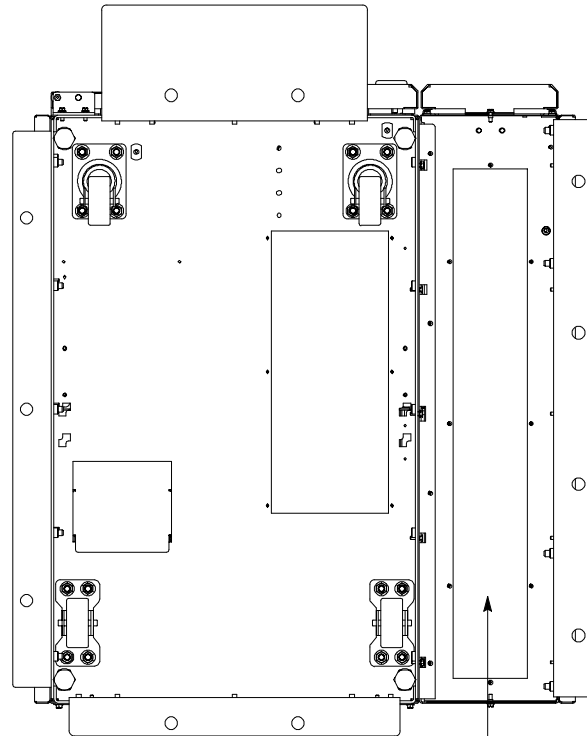

UPS SIDECAR BOTTOM ENTRY
CONDUIT LANDING FOR AC
INPUT AND OUTPUT.
(REMOVE PANEL TO DRILL OR
PUNCH CONDUIT HOLES.)

BOTTOM VIEW

80 KVA UPS

<i>DESCRIPTION:</i> CONDUIT AND WIRE ENTRY LOCATIONS	
<i>DRAWING NO:</i> 164201546-5	<i>SHEET:</i> 1 of 3
<i>REVISION:</i> A	<i>DATE:</i> 031505

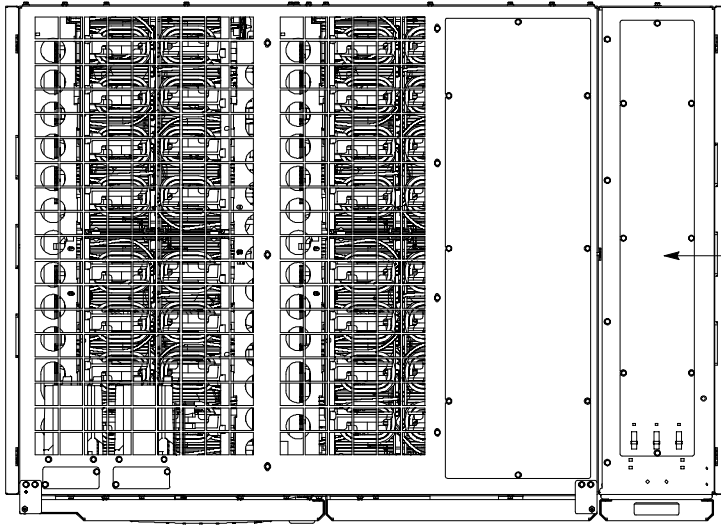

UPS SIDECAR TOP ENTRY
CONDUIT LANDING FOR AC
INPUT AND OUTPUT.
(REMOVE PANEL TO DRILL OR
PUNCH CONDUIT HOLES.)

TOP VIEW

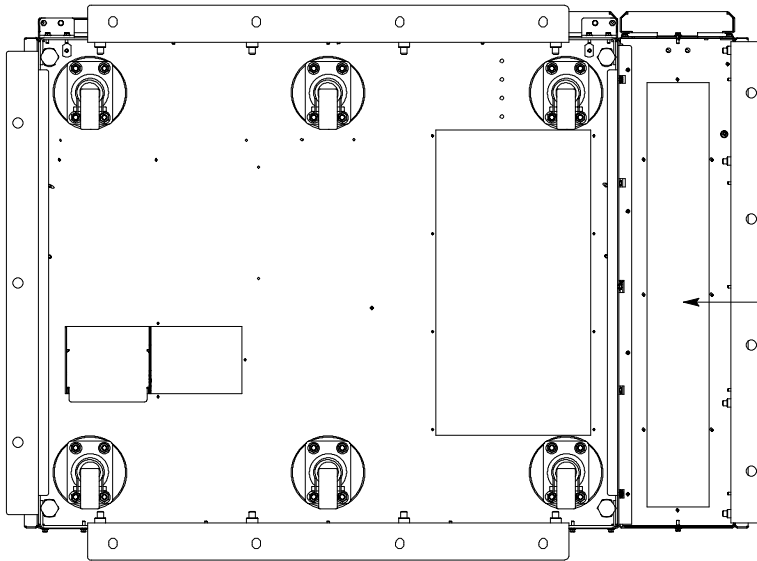

UPS SIDECAR BOTTOM ENTRY
CONDUIT LANDING FOR AC
INPUT AND OUTPUT.
(REMOVE PANEL TO DRILL OR
PUNCH CONDUIT HOLES.)

BOTTOM VIEW

160 KVA UPS

<i>DESCRIPTION:</i> CONDUIT AND WIRE ENTRY LOCATIONS	
<i>DRAWING NO:</i> 164201546-5	<i>SHEET:</i> 2 of 3
<i>REVISION:</i> A	<i>DATE:</i> 031505

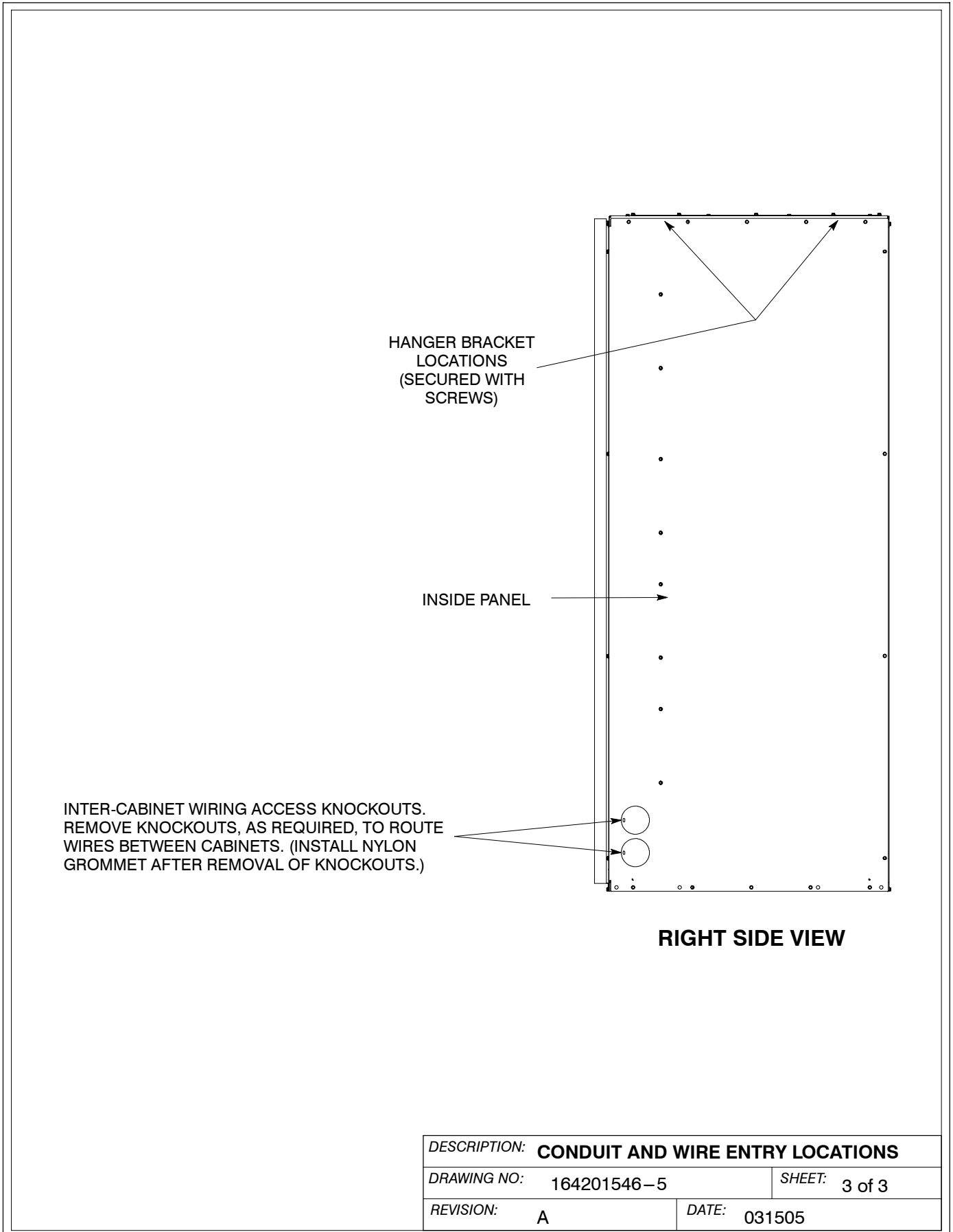

RIGHT SIDE VIEW

<i>DESCRIPTION:</i> CONDUIT AND WIRE ENTRY LOCATIONS		
<i>DRAWING NO:</i>	164201546-5	<i>SHEET:</i> 3 of 3
<i>REVISION:</i>	A	<i>DATE:</i> 031505

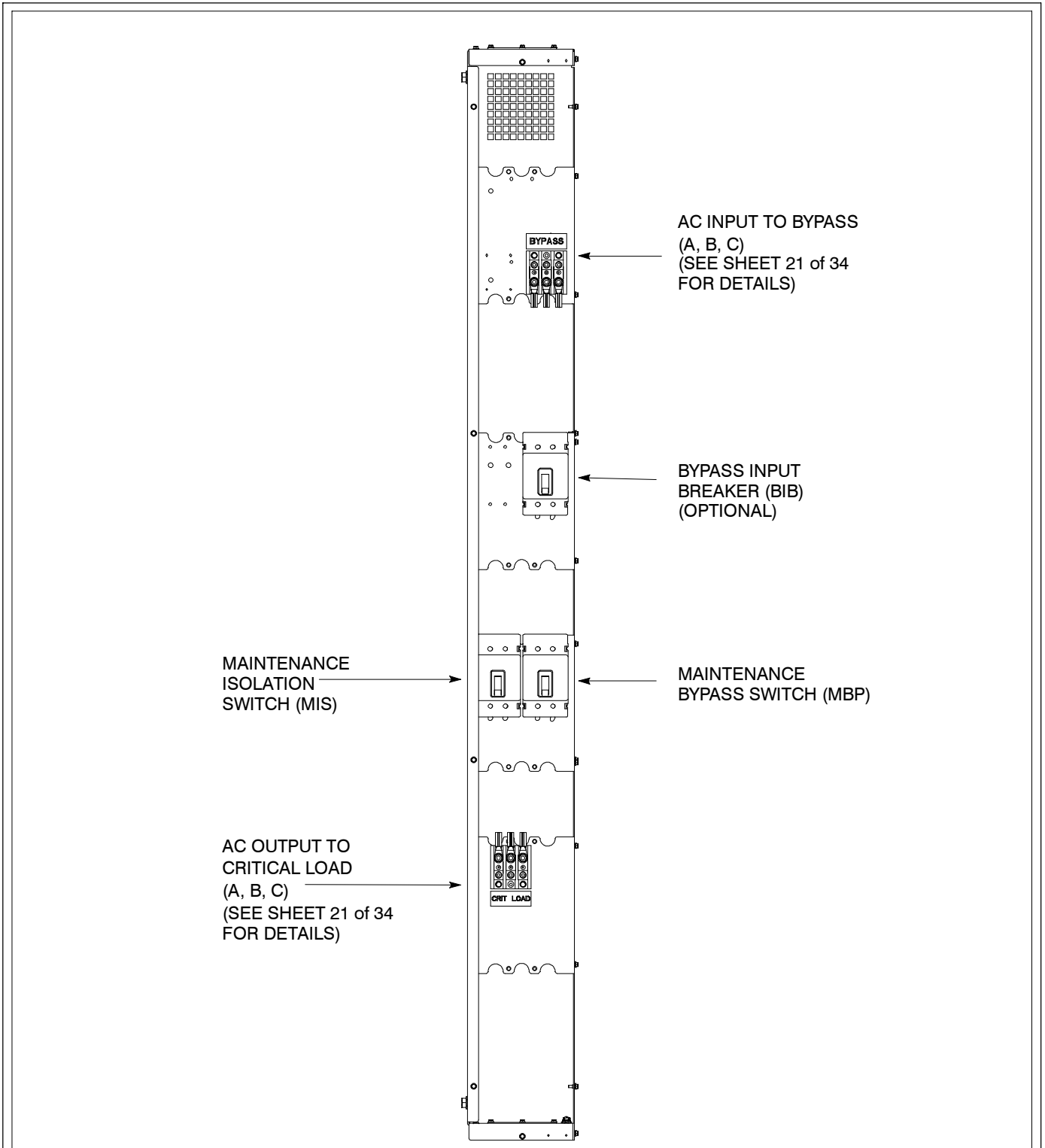

40/20, 40/30, 40/40 KVA, 480/480V
MAINTENANCE BYPASS CONFIGURATION WITH BIB OPTION

NOTE Metal shields covering wiring terminals must be removed to gain access to terminals.

DESCRIPTION: POWER TERMINAL LOCATIONS	
DRAWING NO: 164201546-6	SHEET: 1 of 34
REVISION: D	DATE: 092107

AC INPUT TO UPS
RECTIFIER
(A, B, C)
(SEE SHEET 22 of 34
FOR DETAILS)

RECTIFIER INPUT
BREAKER (RIB)
(OPTIONAL)

AC INPUT TO BYPASS
(A, B, C)
(SEE SHEET 21 of 34
FOR DETAILS)

BYPASS INPUT
BREAKER (BIB)
(OPTIONAL)

MAINTENANCE
ISOLATION
SWITCH (MIS)

MAINTENANCE
BYPASS SWITCH (MBP)

AC OUTPUT TO
CRITICAL LOAD
(A, B, C)
(SEE SHEET 21 of 34
FOR DETAILS)

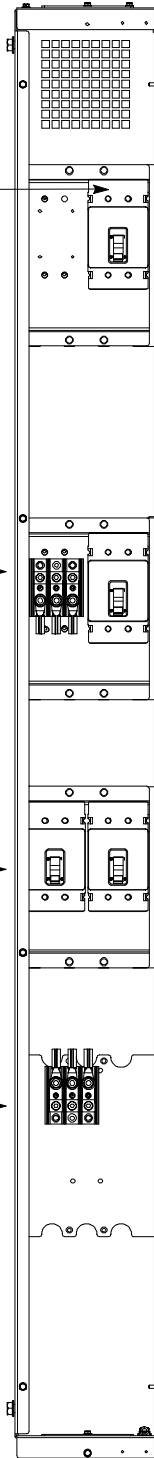

40/20, 40/30, 40/40 KVA, 480/480V
MAINTENANCE BYPASS CONFIGURATION WITH BIB AND RIB OPTIONS

NOTE Metal shields covering wiring terminals must be removed to gain access to terminals.

DESCRIPTION: POWER TERMINAL LOCATIONS	
DRAWING NO: 164201546-6	SHEET: 2 of 34
REVISION: D	DATE: 092107

AC INPUT TO BYPASS
(A, B, C)
(SEE SHEET 23 of 34
FOR DETAILS)

MAINTENANCE
BYPASS SWITCH (MBP)

MAINTENANCE
ISOLATION SWITCH (MIS)

AC OUTPUT TO
CRITICAL LOAD
(A, B, C)
(SEE SHEET 23 of 34
FOR DETAILS)

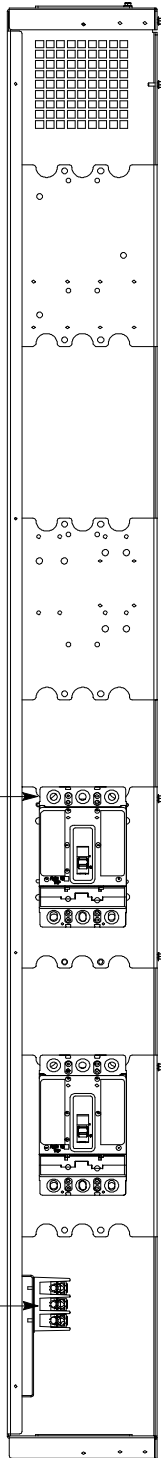

**40/20, 40/30, 40/40 KVA, 208/208V AND 80/40, 80/50, 80/60, 80/80 KVA, 480/480V
MAINTENANCE BYPASS CONFIGURATION**

NOTE 1. Metal shields covering wiring terminals must be removed to access terminals.
2. 80/40 must be wired as 80/50.

DESCRIPTION: POWER TERMINAL LOCATIONS	
DRAWING NO: 164201546-6	SHEET: 3 of 34
REVISION: D	DATE: 092107

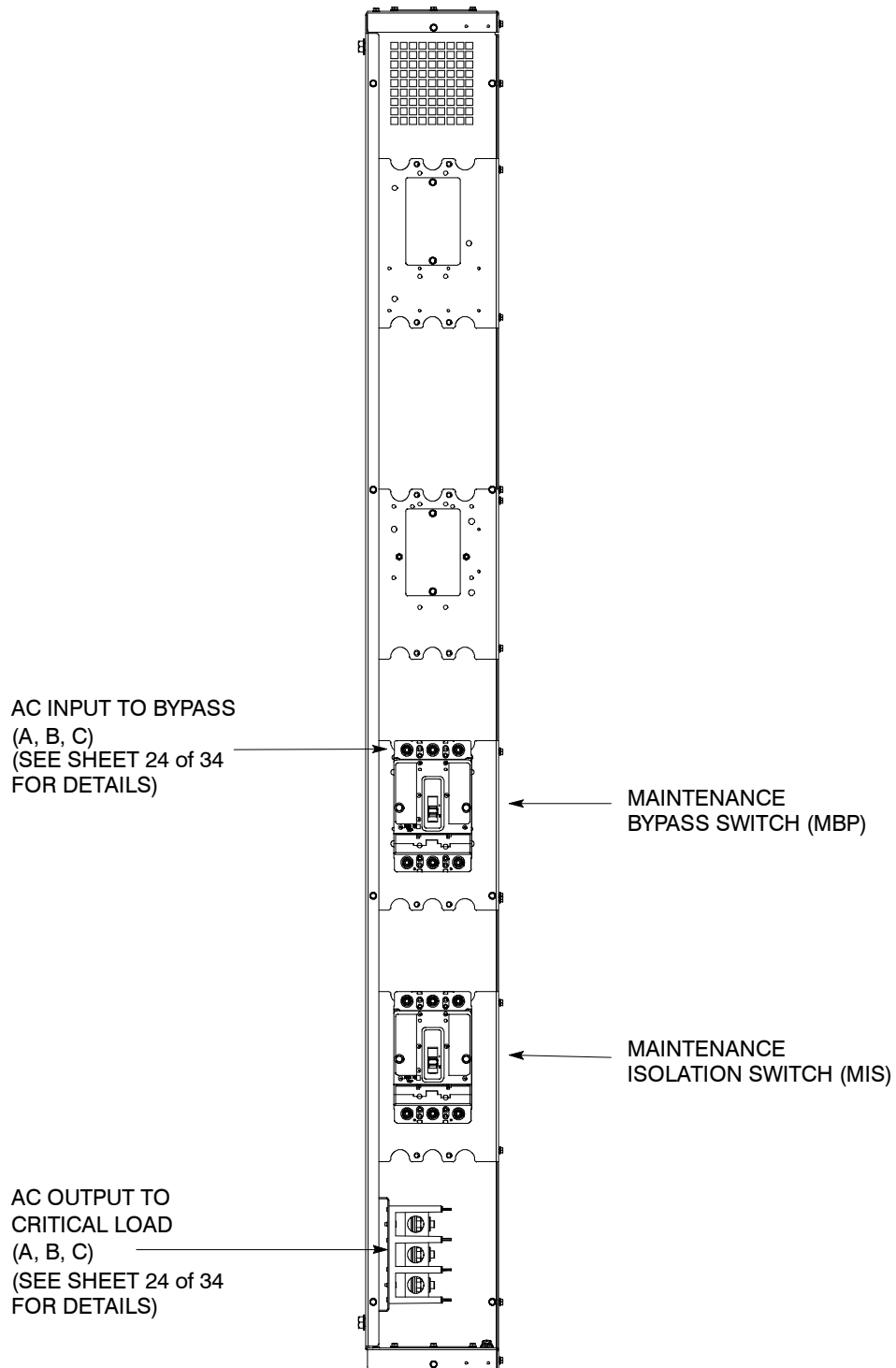

**120/100, 120/120 KVA, 480/480V
MAINTENANCE BYPASS CONFIGURATION**

NOTE Metal shields covering wiring terminals must be removed to access terminals.

DESCRIPTION: POWER TERMINAL LOCATIONS	
DRAWING NO: 164201546-6	SHEET: 4 of 34
REVISION: D	DATE: 092107

AC INPUT TO BYPASS
(A, B, C)
(SEE SHEET 23 of 34
FOR DETAILS)

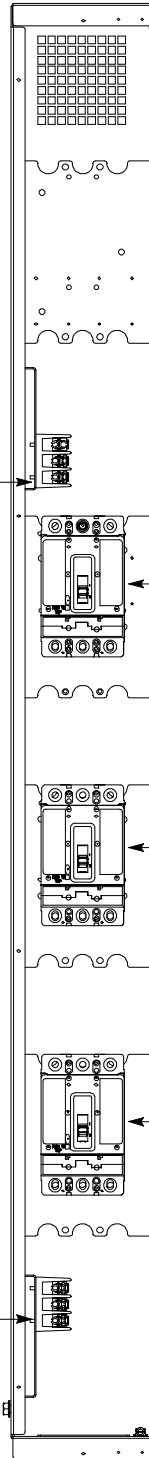

BYPASS INPUT BREAKER
(BIB)

MAINTENANCE
BYPASS SWITCH (MBP)

MAINTENANCE
ISOLATION SWITCH (MIS)

AC OUTPUT TO
CRITICAL LOAD
(A, B, C)
(SEE SHEET 23 of 34
FOR DETAILS)

**40/20, 40/30, 40/40 KVA, 208/208V AND 80/40, 80/50, 80/60, 80/80 KVA, 480/480V
MAINTENANCE BYPASS CONFIGURATION WITH OPTIONAL BIB**

NOTE 1. Metal shields covering wiring terminals must be removed to access terminals.
2. 80/40 must be wired as 80/50.

DESCRIPTION: POWER TERMINAL LOCATIONS	
DRAWING NO: 164201546-6	SHEET: 5 of 34
REVISION: D	DATE: 092107

AC INPUT TO BYPASS
(A, B, C)
(SEE SHEET 25 of 34
FOR DETAILS)

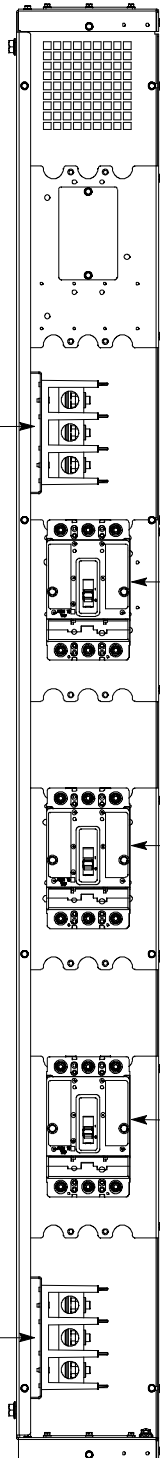

BYPASS INPUT BREAKER
(BIB)

MAINTENANCE
BYPASS SWITCH (MBP)

MAINTENANCE
ISOLATION SWITCH (MIS)

AC OUTPUT TO
CRITICAL LOAD
(A, B, C)
(SEE SHEET 25 of 34
FOR DETAILS)

120/100, 120/120 KVA, 480/480V
MAINTENANCE BYPASS CONFIGURATION WITH OPTIONAL BIB

NOTE Metal shields covering wiring terminals must be removed to access terminals.

DESCRIPTION: POWER TERMINAL LOCATIONS	
DRAWING NO: 164201546-6	SHEET: 6 of 34
REVISION: C	DATE: 062806

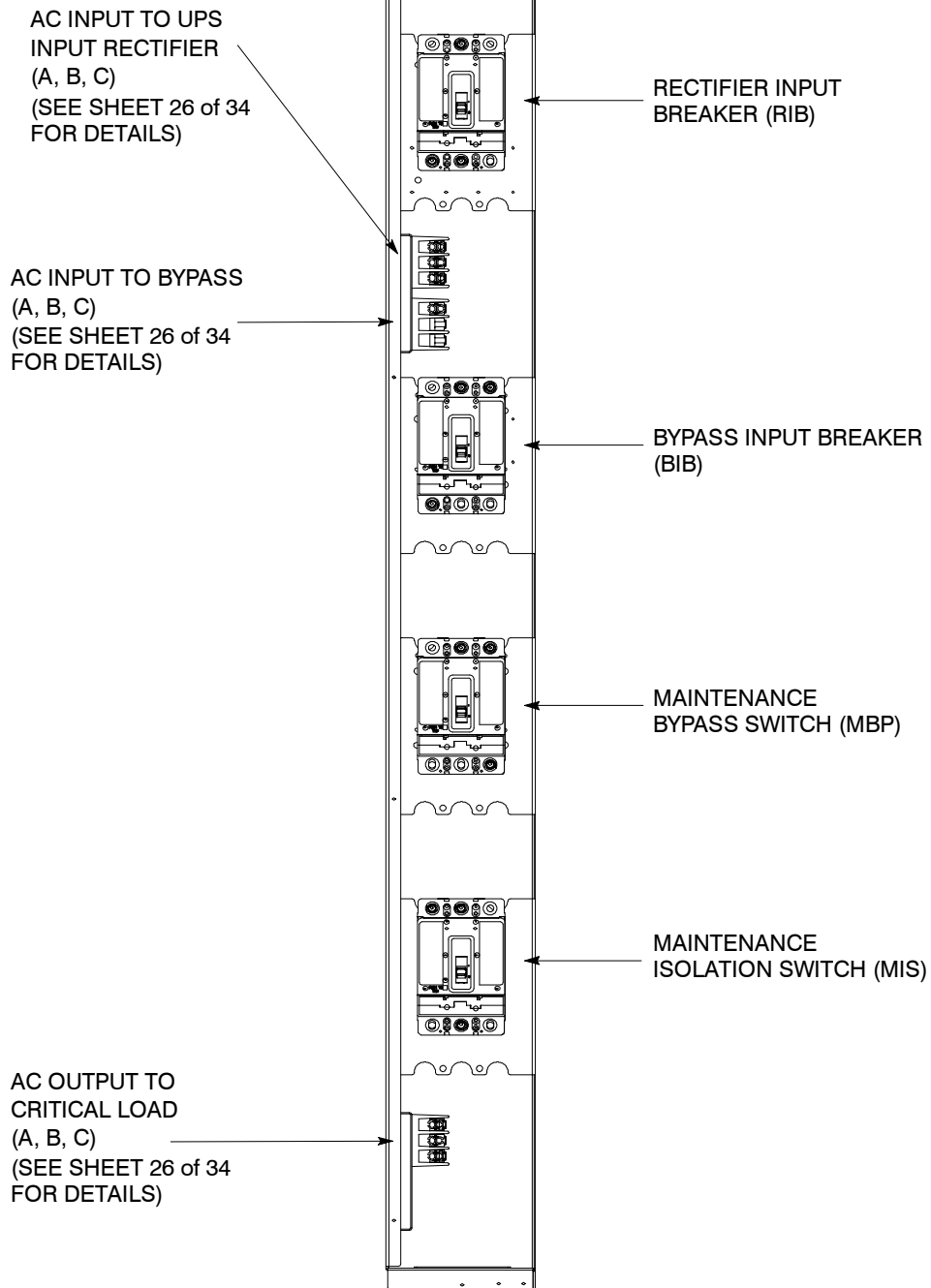

**40/20, 40/30, 40/40 KVA, 208/208V AND 80/40, 80/50, 80/60, 80/80 KVA, 480/480V
MAINTENANCE BYPASS CONFIGURATION WITH BIB AND RIB OPTIONS**

NOTE 1. Metal shields covering wiring terminals must be removed to access terminals.
2. 80/40 must be wired as 80/50.

DESCRIPTION: POWER TERMINAL LOCATIONS	
DRAWING NO: 164201546-6	SHEET: 7 of 34
REVISION: D	DATE: 092107

AC INPUT TO RECTIFIER
(A, B, C)
(SEE SHEET 25 of 34
FOR DETAILS)

RECTIFIER INPUT
BREAKER (RIB)

AC INPUT TO BYPASS
(A, B, C)
(SEE SHEET 25 of 34
FOR DETAILS)

BYPASS INPUT BREAKER
(BIB)

MAINTENANCE
BYPASS SWITCH (MBP)

MAINTENANCE
ISOLATION SWITCH (MIS)

AC OUTPUT TO
CRITICAL LOAD
(A, B, C)
(SEE SHEET 25 of 34
FOR DETAILS)

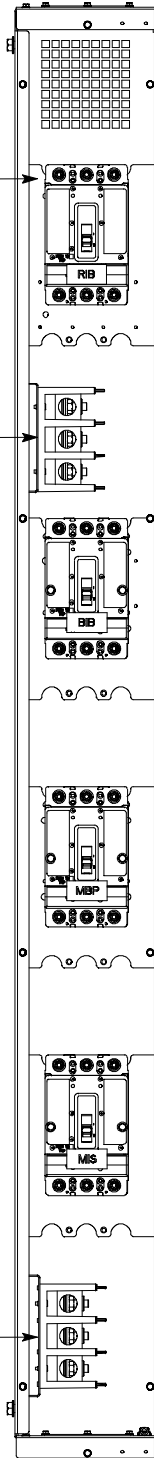

120/100, 120/120 KVA, 480/480V

MAINTENANCE BYPASS CONFIGURATION WITH BIB AND RIB OPTIONS

NOTE Metal shields covering wiring terminals must be removed to access terminals.

DESCRIPTION: POWER TERMINAL LOCATIONS	
DRAWING NO: 164201546-6	SHEET: 8 of 34
REVISION: C	DATE: 062806

AC INPUT TO BYPASS
(A, B, C)
(SEE SHEET 27 of 34
FOR DETAILS)

AC OUTPUT TO
CRITICAL LOAD
(A, B, C)
(SEE SHEET 27 of 34
FOR DETAILS)

MAINTENANCE
BYPASS SWITCH (MBP)

MAINTENANCE
ISOLATION SWITCH (MIS)

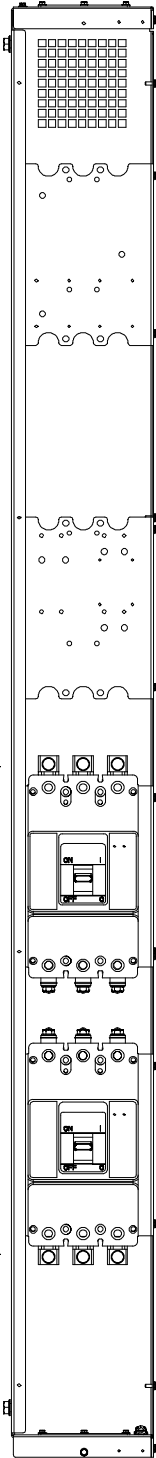

**80/40, 80/50, 80/60, 80/80 KVA, 208/208V,
AND 160/100, 160/120, 160/160 KVA, 480/480V**

MAINTENANCE BYPASS CONFIGURATION

- NOTE** 1. Metal shields covering wiring terminals must be removed to access terminals.
2. 80/40 must be wired as 80/50.
3. 160/100 must be wired as 160/120.

DESCRIPTION: POWER TERMINAL LOCATIONS	
DRAWING NO: 164201546-6	SHEET: 9 of 34
REVISION: C	DATE: 062806

AC INPUT TO UPS
RECTIFIER
(A, B, C)
(SEE SHEET 28 of 34
FOR DETAILS)

AC INPUT TO BYPASS
(A, B, C)
(SEE SHEET 28 of 34
FOR DETAILS)

AC OUTPUT TO
CRITICAL LOAD
(A, B, C)
(SEE SHEET 27 of 34
FOR DETAILS)

RECTIFIER INPUT
BREAKER (RIB)
(OPTIONAL)

BYPASS INPUT
BREAKER (BIB)
(OPTIONAL)

MAINTENANCE
BYPASS SWITCH (MBP)

MAINTENANCE
ISOLATION SWITCH (MIS)

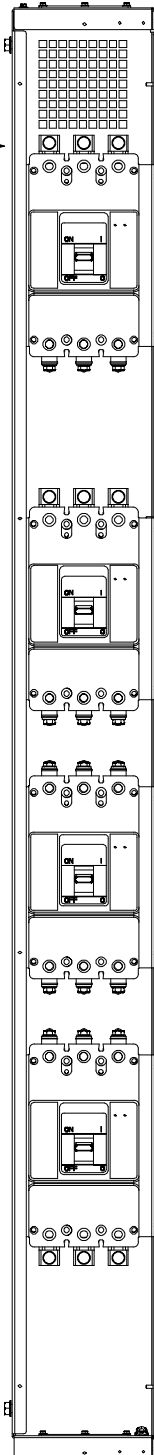

**80/40, 80/50, 80/60, 80/80 KVA, 208/208V AND
160/100, 160/120, 160/160 KVA, 480/480V**

MAINTENANCE BYPASS CONFIGURATION WITH BIB AND RIB OPTIONS

- NOTE**
1. Metal shields covering wiring terminals must be removed to access terminals.
 2. 80/40 must be wired as 80/50.
 3. 160/100 must be wired a 160/120.

DESCRIPTION: POWER TERMINAL LOCATIONS	
DRAWING NO: 164201546-6	SHEET: 10 of 34
REVISION: C	DATE: 062806

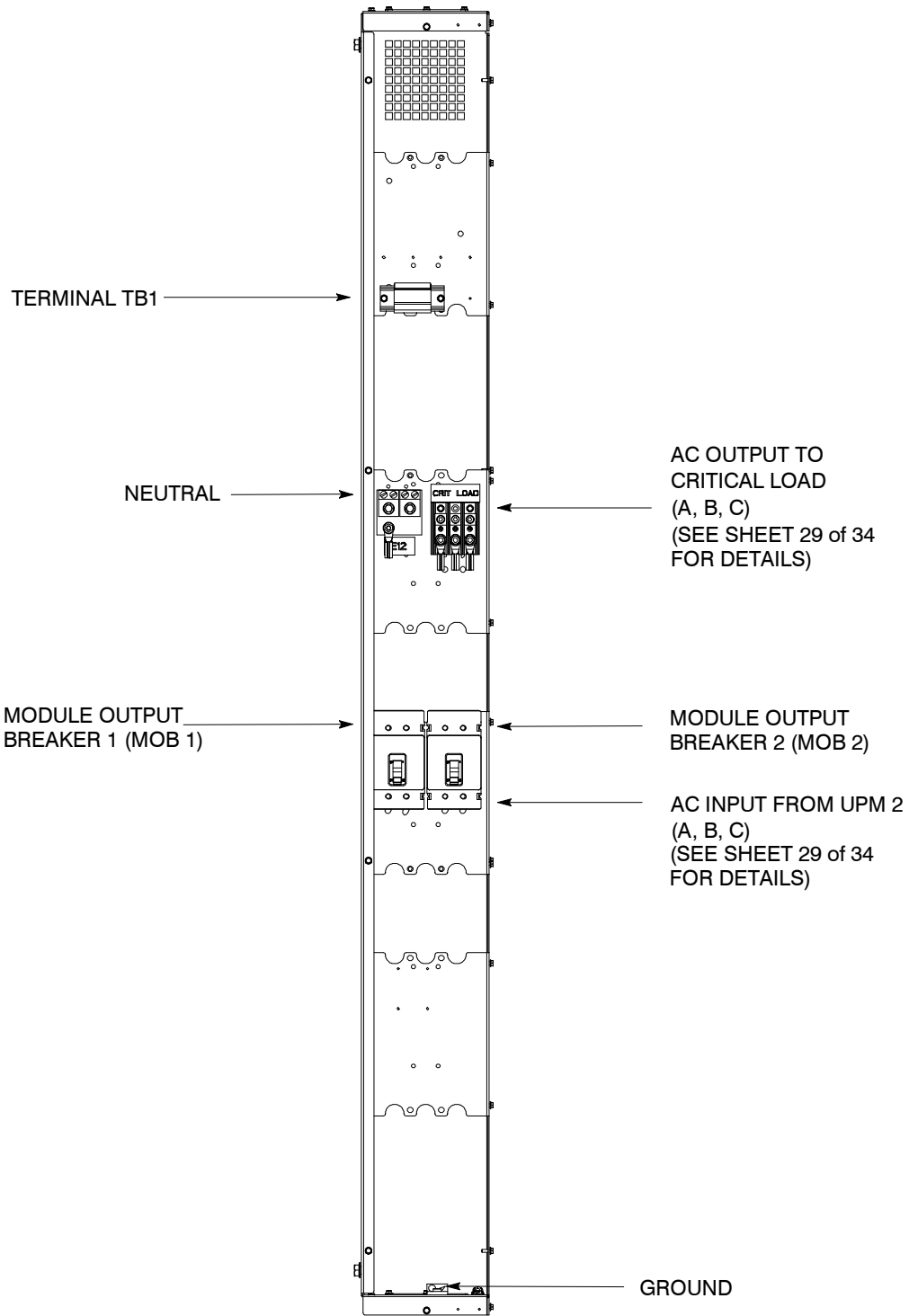

40/20, 40/30, 40/40 KVA 480/480V

PARALLEL REDUNDANT CONFIGURATION

NOTE Metal shields covering wiring terminals must be removed to access terminals.

DESCRIPTION: POWER TERMINAL LOCATIONS		
DRAWING NO:	164201546-6	SHEET: 11 of 34
REVISION:	E	DATE: 092107

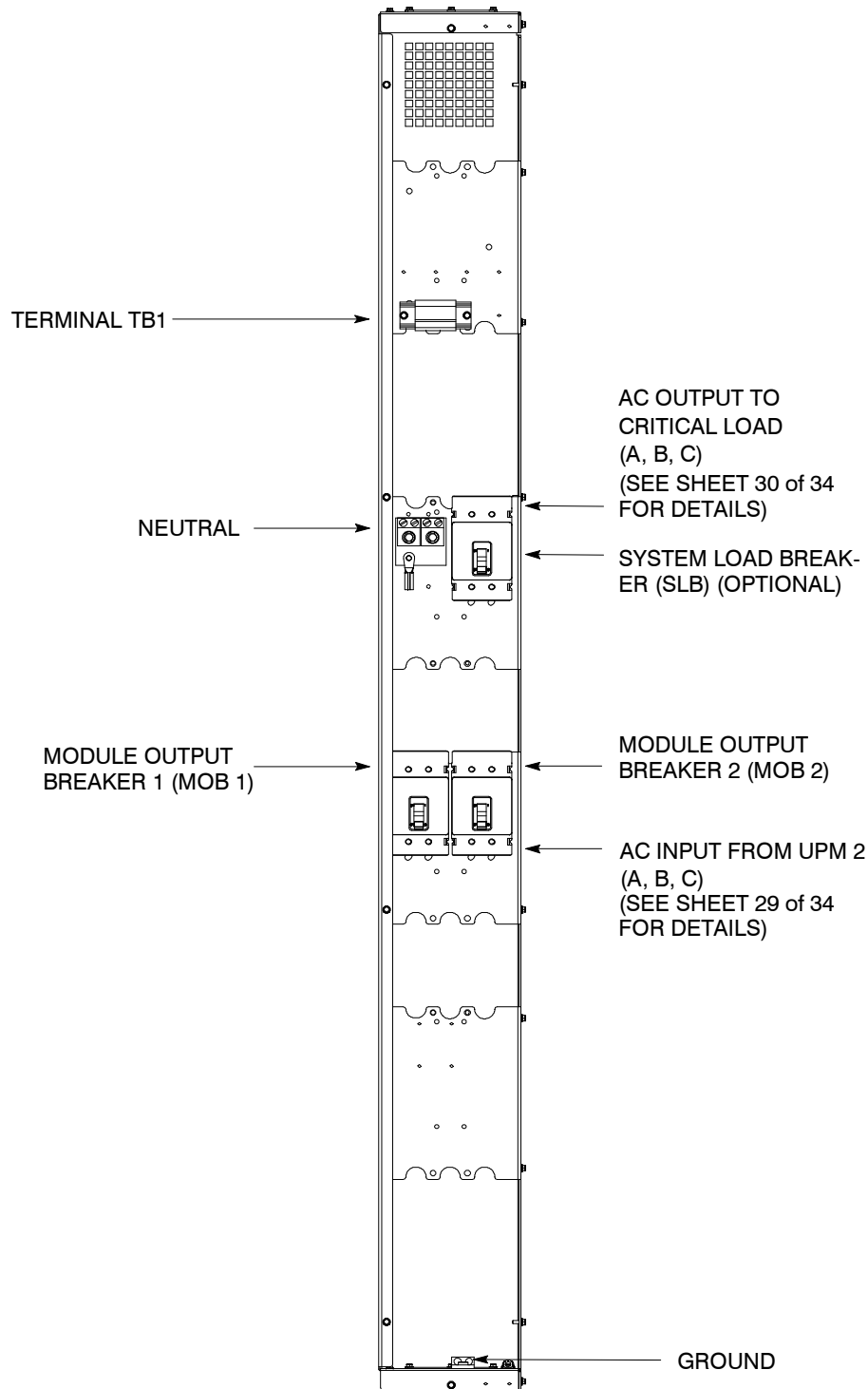

40/20, 40/30, 40/40 KVA 480/480V

PARALLEL REDUNDANT CONFIGURATION WITH SLB

NOTE Metal shields covering wiring terminals must be removed to access terminals.

DESCRIPTION: POWER TERMINAL LOCATIONS		
DRAWING NO:	164201546-6	SHEET: 12 of 34
REVISION:	E	DATE: 092107

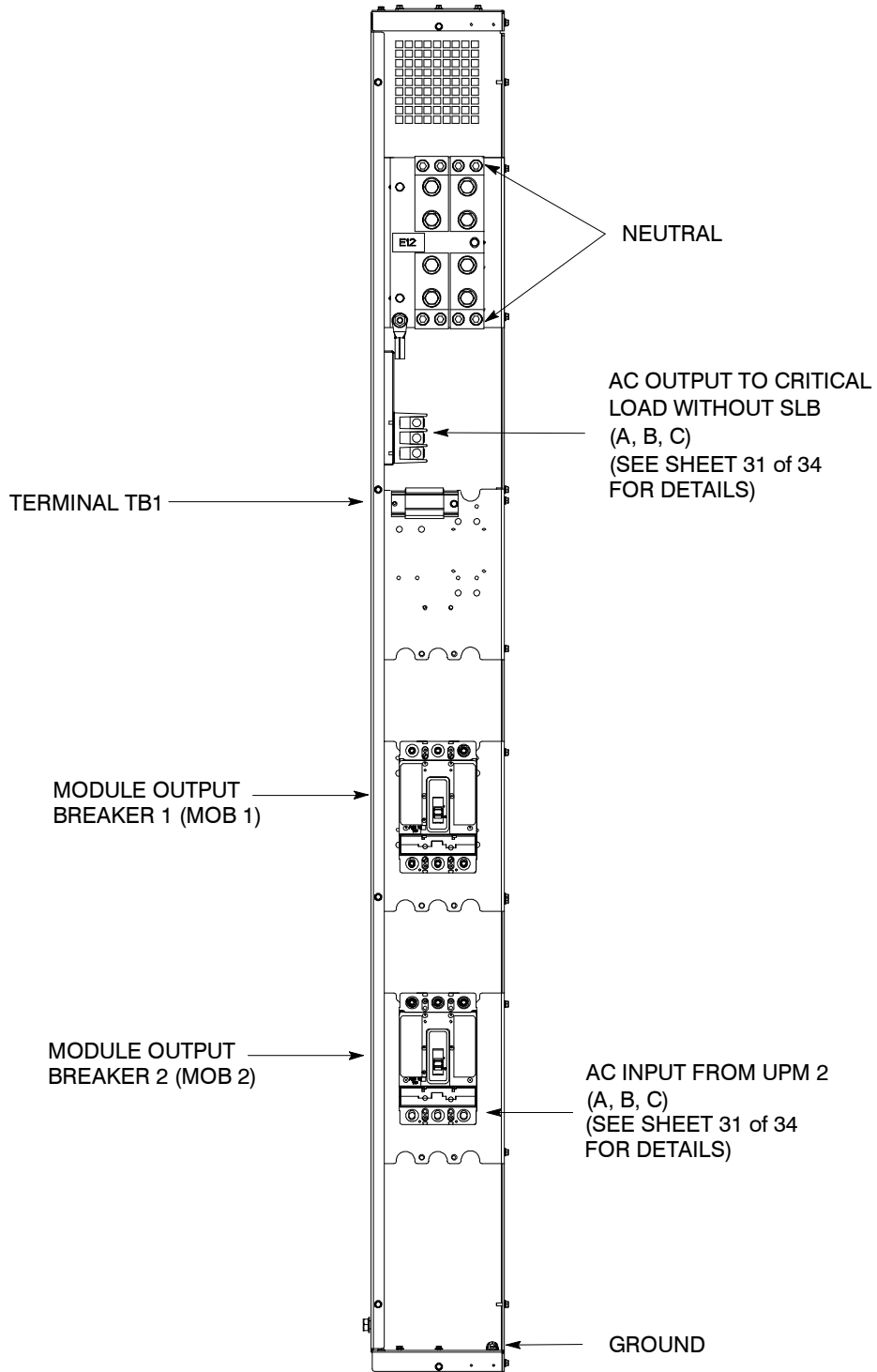

**40/20, 40/30, 40/40 KVA, 208/208V
PARALLEL REDUNDANT CONFIGURATION**

NOTE Metal shields covering wiring terminals must be removed to access terminals.

DESCRIPTION: POWER TERMINAL LOCATIONS		
DRAWING NO:	164201546-6	SHEET: 13 of 34
REVISION:	E	DATE: 092107

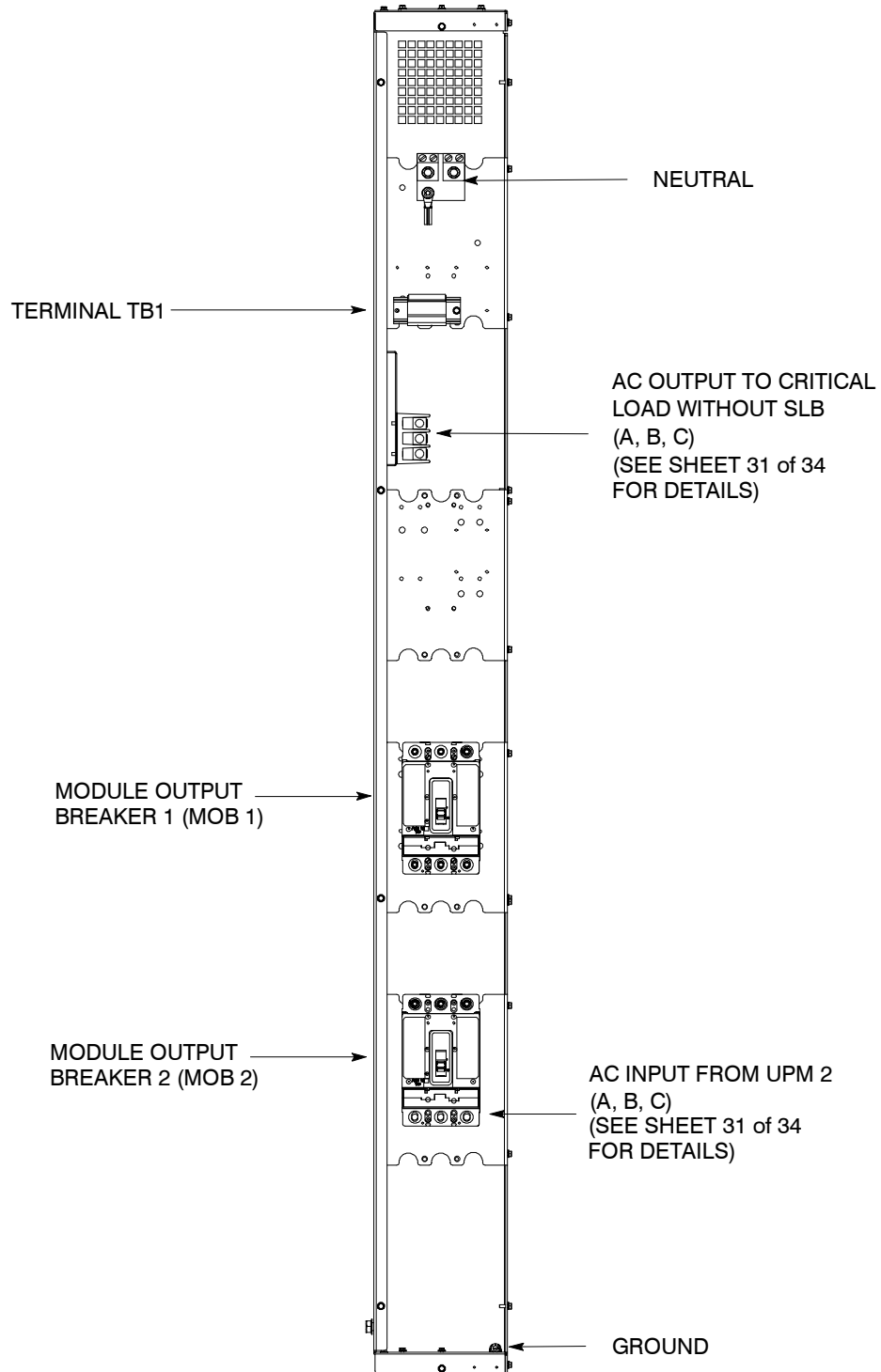

**80/40, 80/50, 80/60, 80/80 KVA, 480/480V
PARALLEL REDUNDANT CONFIGURATION**

NOTE Metal shields covering wiring terminals must be removed to access terminals.

DESCRIPTION: POWER TERMINAL LOCATIONS	
DRAWING NO: 164201546-6	SHEET: 14 of 34
REVISION: E	DATE: 092107

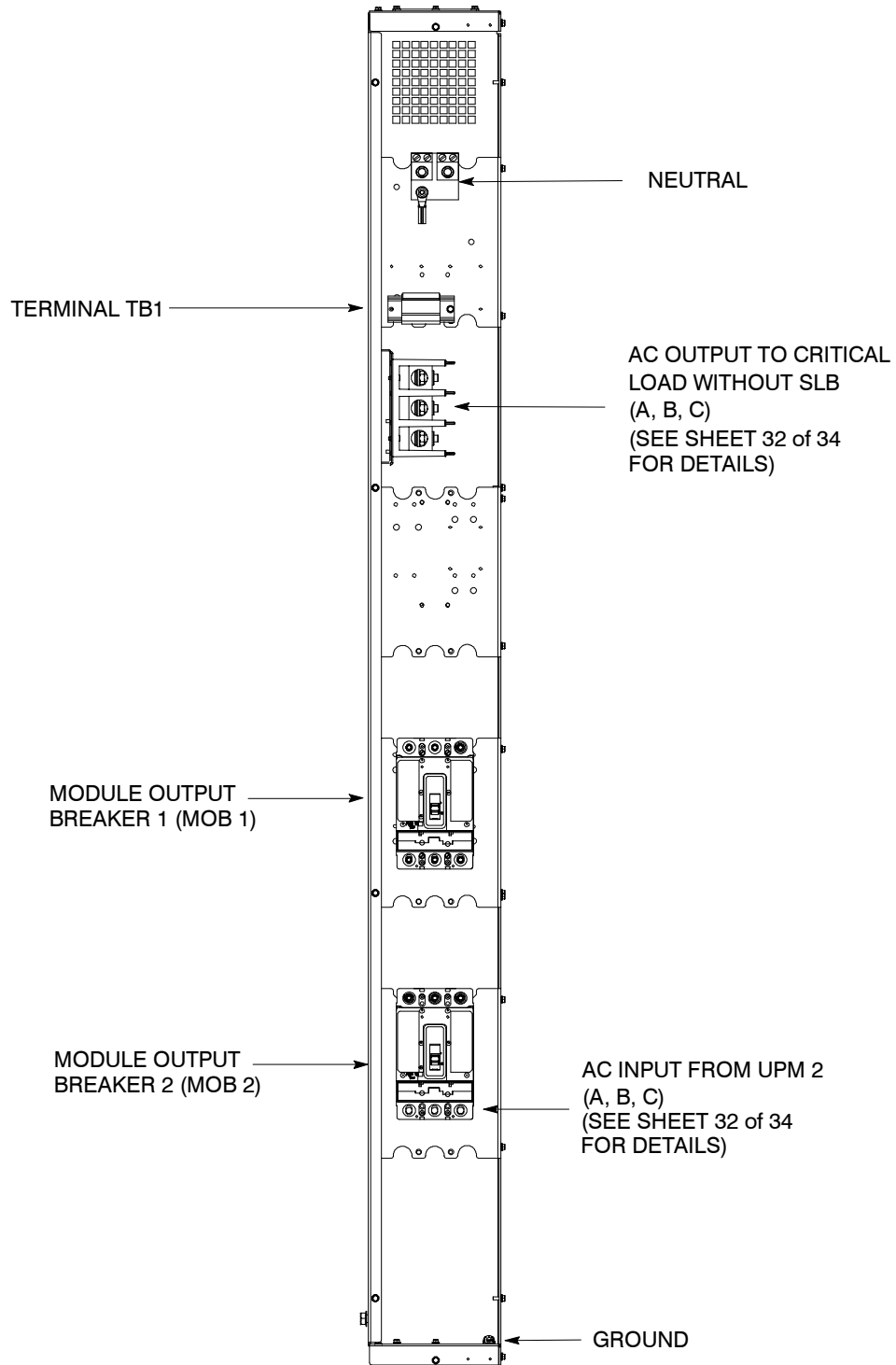

**120/100, 120/120 KVA, 480/480V
PARALLEL REDUNDANT CONFIGURATION**

NOTE Metal shields covering wiring terminals must be removed to access terminals.

DESCRIPTION: POWER TERMINAL LOCATIONS		
DRAWING NO:	164201546-6	SHEET: 15 of 34
REVISION:	D	DATE: 063006

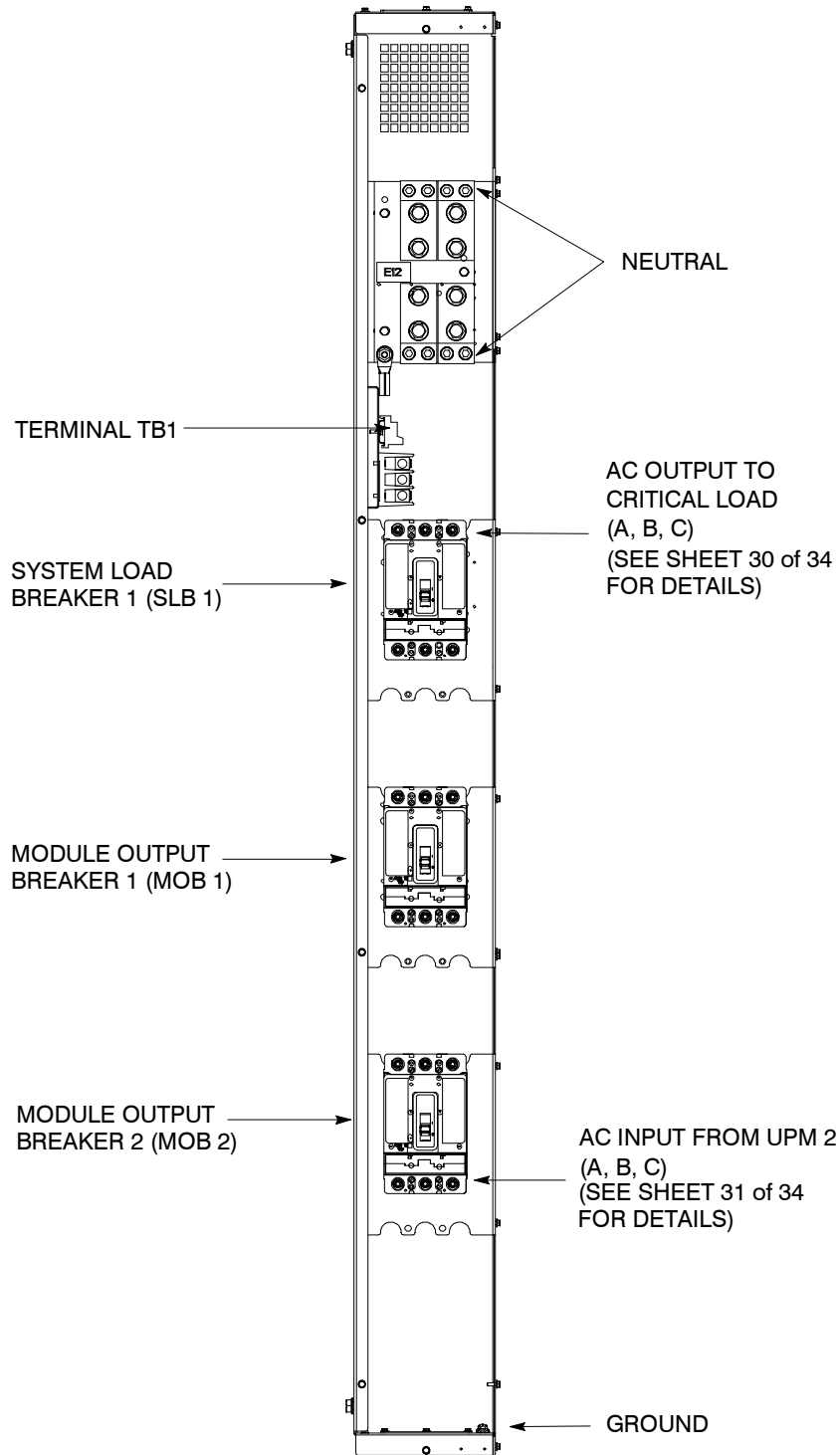

**40/20, 40/30, 40/40 KVA, 208/208V
PARALLEL REDUNDANT CONFIGURATION W/SLB**

NOTE 1. Metal shields covering wiring terminals must be removed to access terminals.
2. 80/40 must be wired as 80/50.

DESCRIPTION: POWER TERMINAL LOCATIONS		
DRAWING NO:	164201546-6	SHEET: 16 of 34
REVISION:	E	DATE: 092107

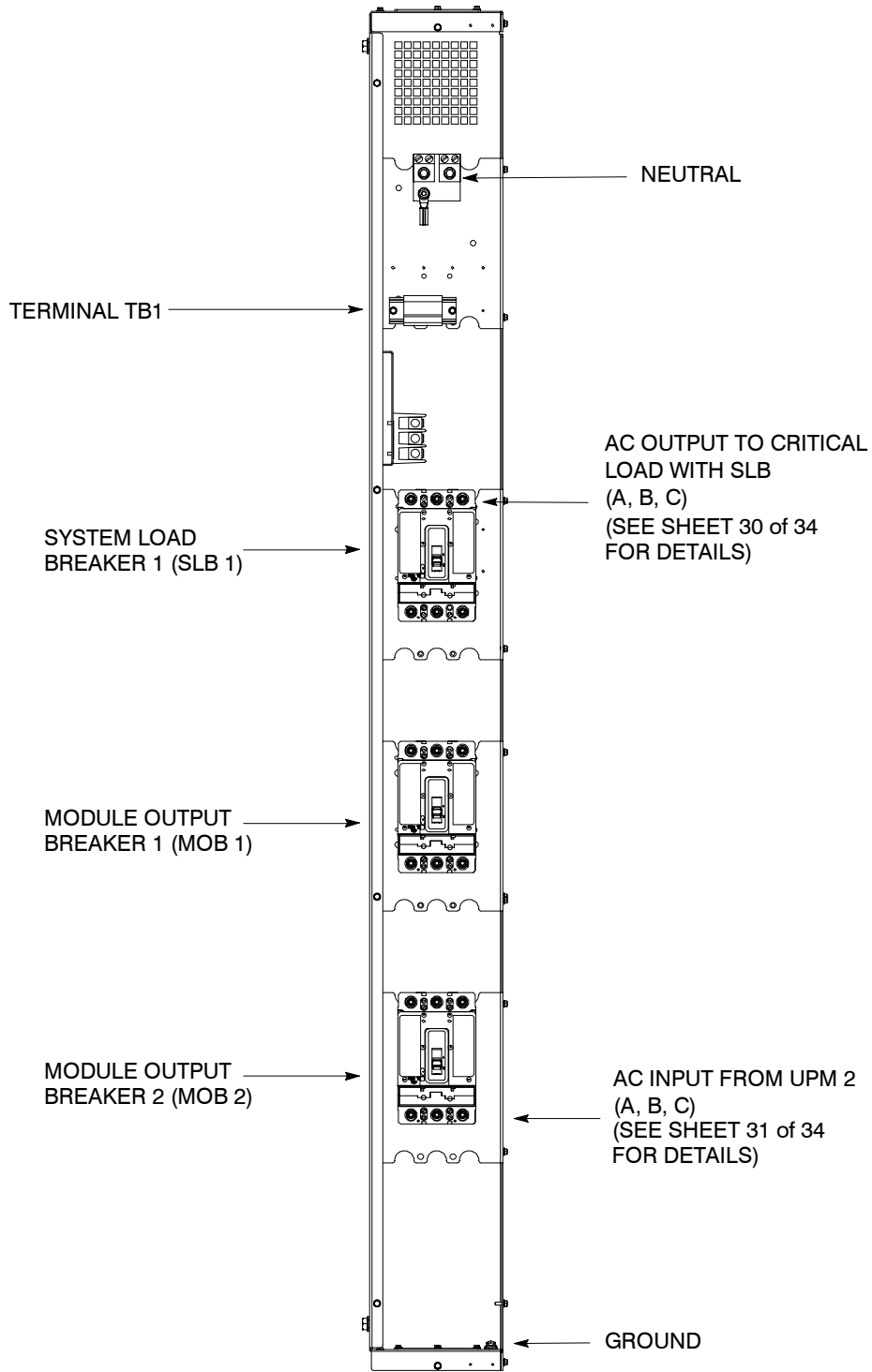

**80/40, 80/50, 80/60, 80/80 KVA, 480/480V
PARALLEL REDUNDANT CONFIGURATION W/SLB**

NOTE 1. Metal shields covering wiring terminals must be removed to access terminals.
2. 80/40 must be wired as 80/50.

DESCRIPTION: POWER TERMINAL LOCATIONS	
DRAWING NO: 164201546-6	SHEET: 17 of 34
REVISION: E	DATE: 061507

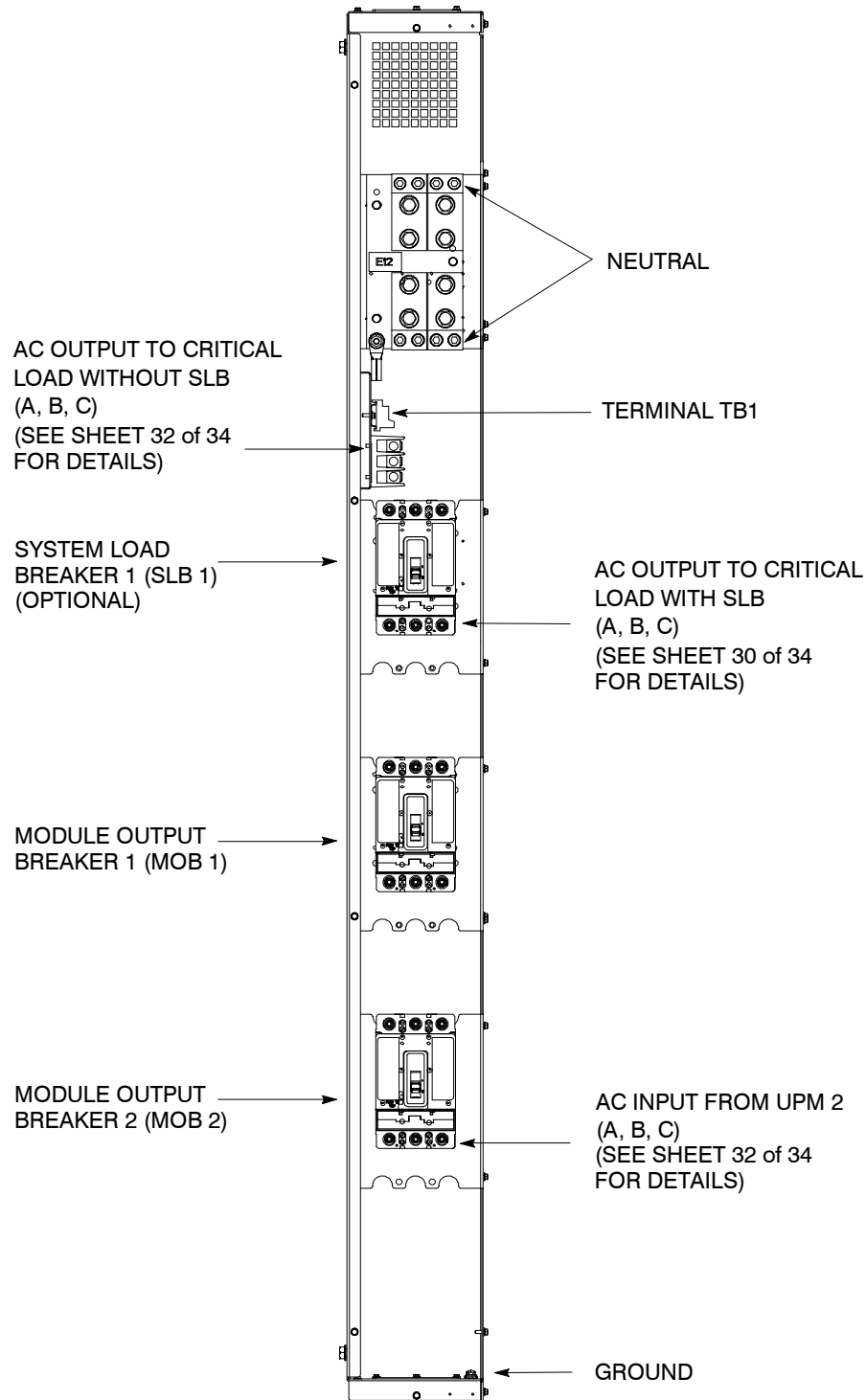

**120/100, 120/120 KVA, 480/480V
PARALLEL REDUNDANT CONFIGURATION**

NOTE 1. Metal shields covering wiring terminals must be removed to access terminals.
2. 80/40 must be wired as 80/50.

DESCRIPTION: POWER TERMINAL LOCATIONS	
DRAWING NO: 164201546-6	SHEET: 18 of 34
REVISION: E	DATE: 063006

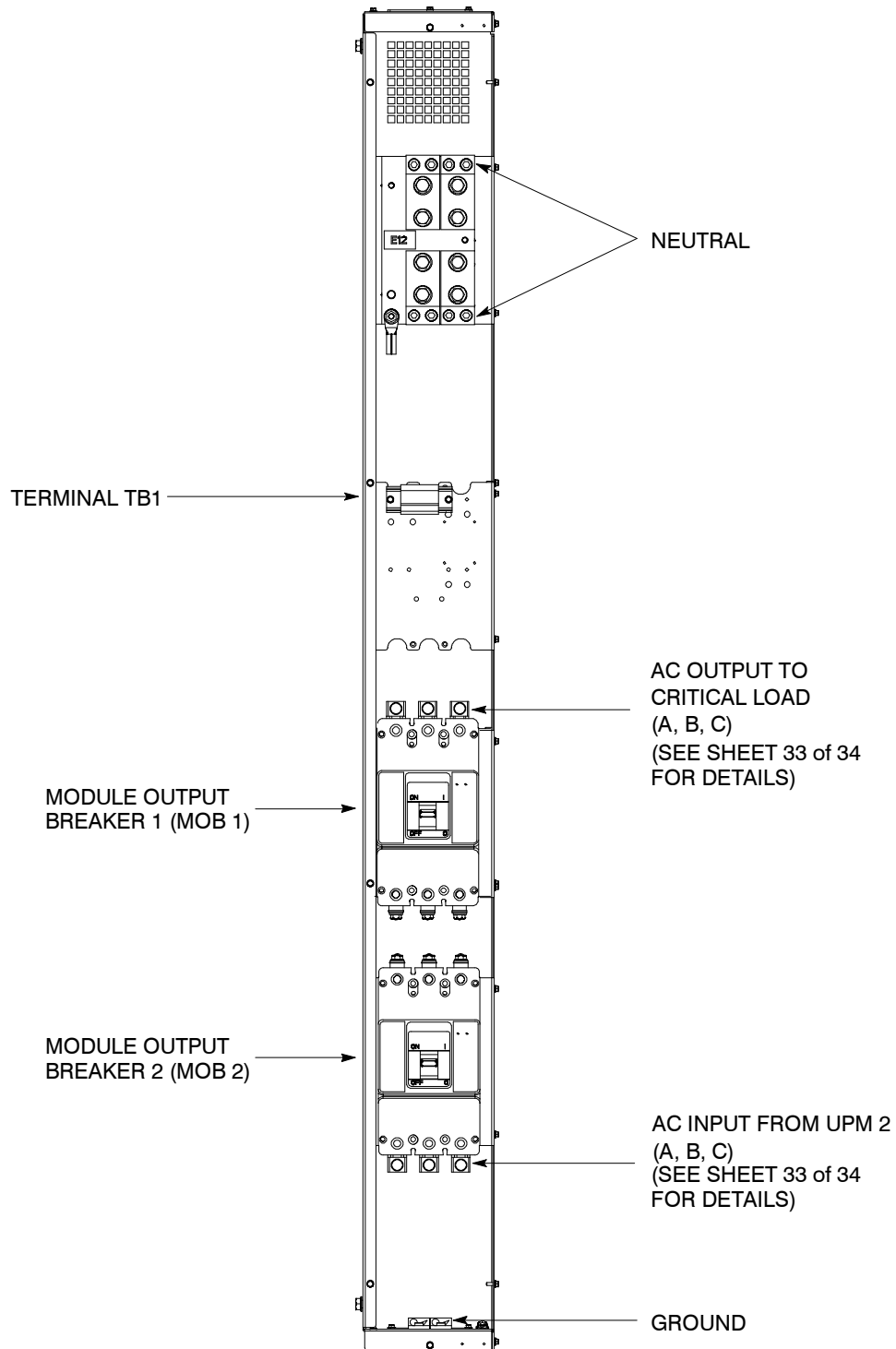

**80/40, 80/50, 80/60, 80/80 KVA, 208/208V AND
160/100, 160/120, 160/160 KVA, 480/480V
PARALLEL REDUNDANT CONFIGURATION**

- NOTE** 1. Metal shields covering wiring terminals must be removed to access terminals.
2. 80/40 must be wired as 80/50.
3. 160/100 must be wired as 160/120.

DESCRIPTION: POWER TERMINAL LOCATIONS	
DRAWING NO: 164201546-6	SHEET: 19 of 34
REVISION: D	DATE: 063006

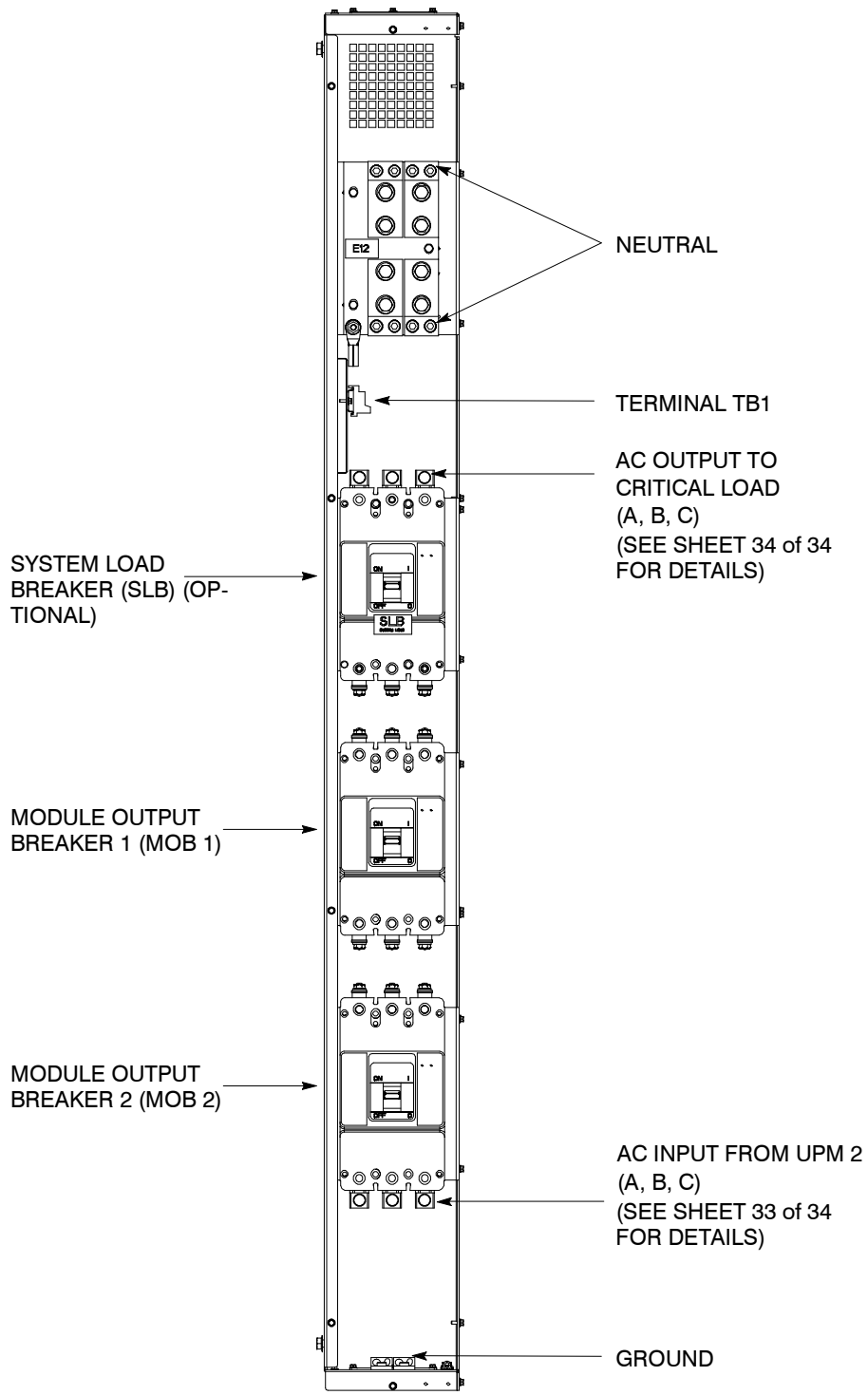

**80/40, 80/50, 80/60, 80/80 KVA, 208/208V AND
160/100, 160/120, 160/160 KVA, 480/480V
PARALLEL REDUNDANT CONFIGURATION WITH SLB**

- NOTE** 1. Metal shields covering wiring terminals must be removed to access terminals.
 2. 80/40 must be wired as 80/50.
 3. 160/100 must be wired as 160/120.

DESCRIPTION: POWER TERMINAL LOCATIONS	
DRAWING NO: 164201546-6	SHEET: 20 of 34
REVISION: D	DATE: 063006

40/20, 40/30, 40/40 KVA, 480/480V UPS SIDECAR MAINTENANCE BYPASS CONFIGURATION INPUT AND LOAD OUTPUT TERMINAL DETAIL

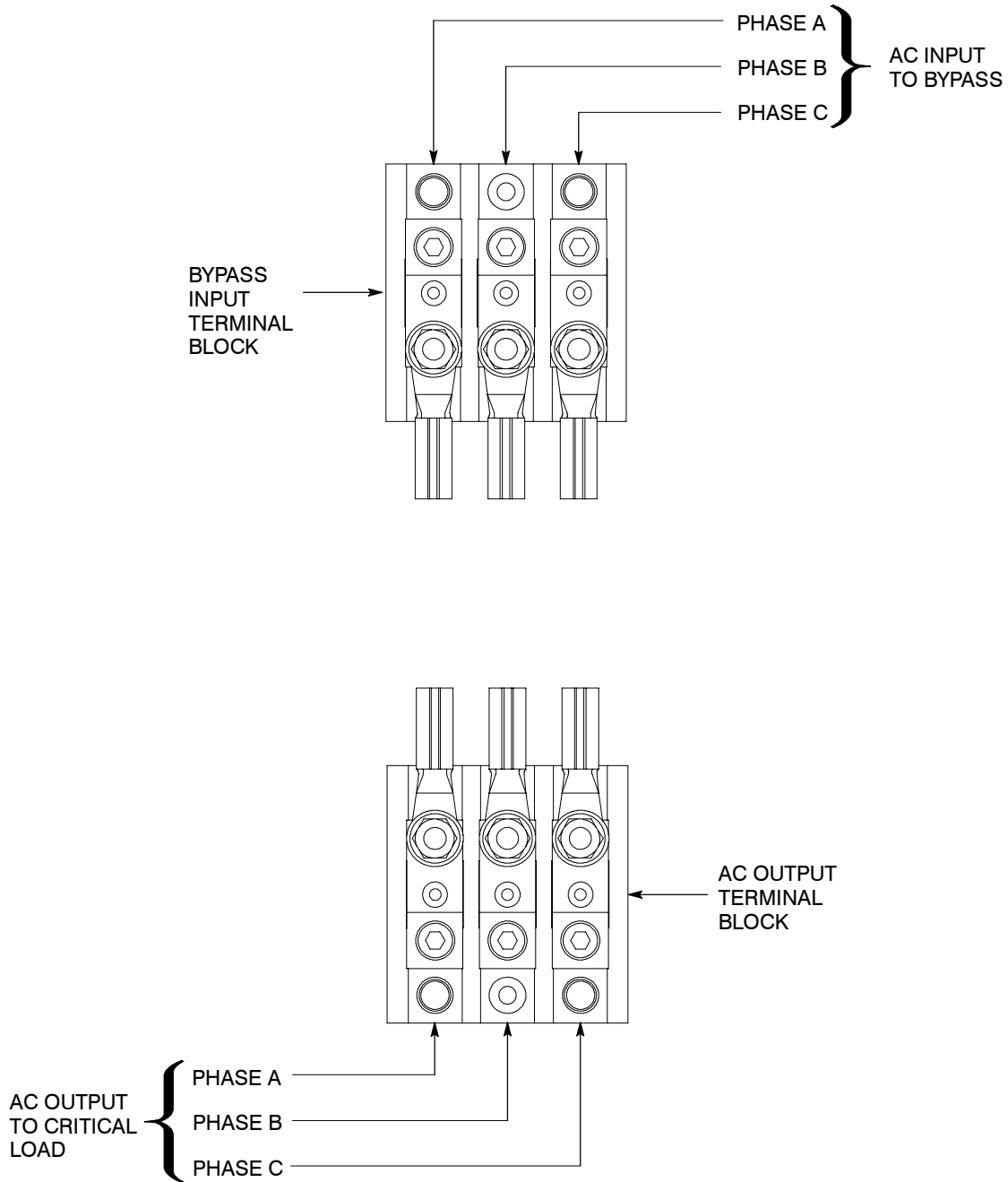

DESCRIPTION: POWER TERMINAL LOCATIONS	
DRAWING NO: 164201546-6	SHEET: 21 of 34
REVISION: D	DATE: 092107

**40/20, 40/30, 40/40 KVA, 480/480V UPS SIDECAR
 MAINTENANCE BYPASS CONFIGURATION
 RECTIFIER INPUT TERMINAL DETAIL**

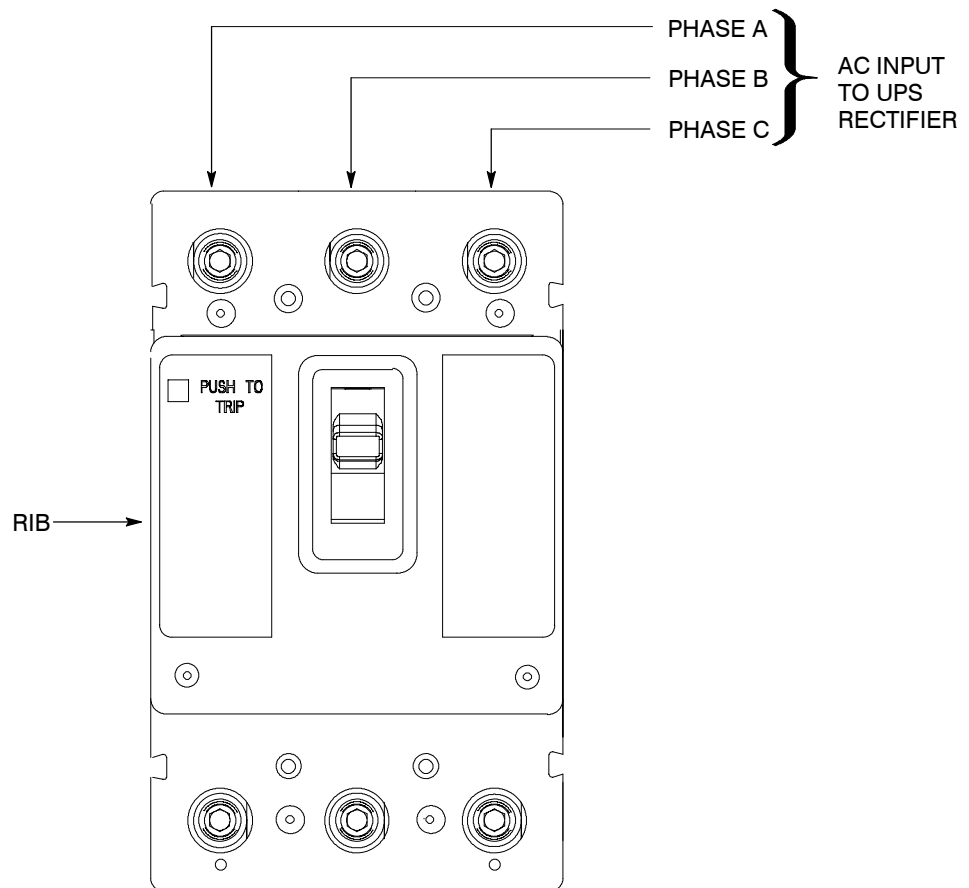

<i>DESCRIPTION:</i> POWER TERMINAL LOCATIONS	
<i>DRAWING NO:</i> 164201546-6	<i>SHEET:</i> 22 of 34
<i>REVISION:</i> D	<i>DATE:</i> 092107

40/20, 40/30, 40/40 KVA, 208/208V AND 80/40, 80/50, 80/60, 80/80 KVA, 480/480V MAINTENANCE BYPASS CONFIGURATION INPUT AND LOAD OUTPUT TERMINAL DETAIL

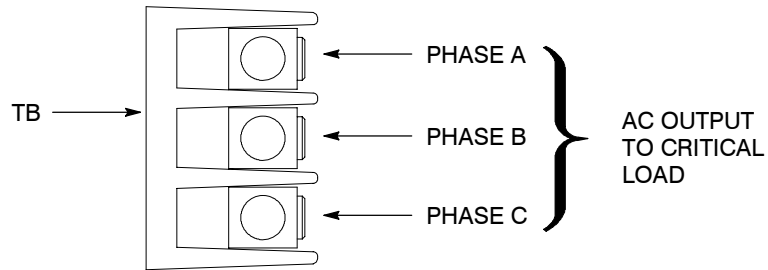
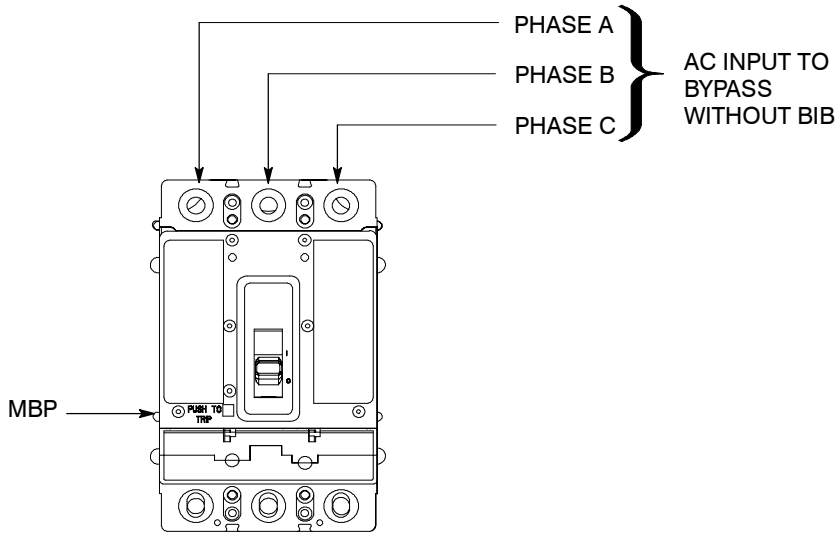
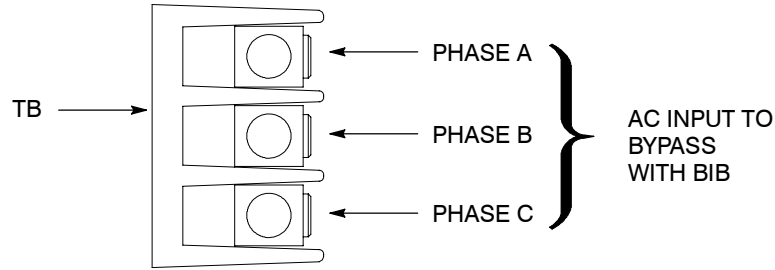

DESCRIPTION: POWER TERMINAL LOCATIONS		
DRAWING NO: 164201546-6	SHEET: 23 of 34	
REVISION: D	DATE: 092107	

120/100, 120/120 KVA, 480/480V MAINTENANCE BYPASS CONFIGURATION INPUT AND LOAD OUTPUT TERMINAL DETAIL

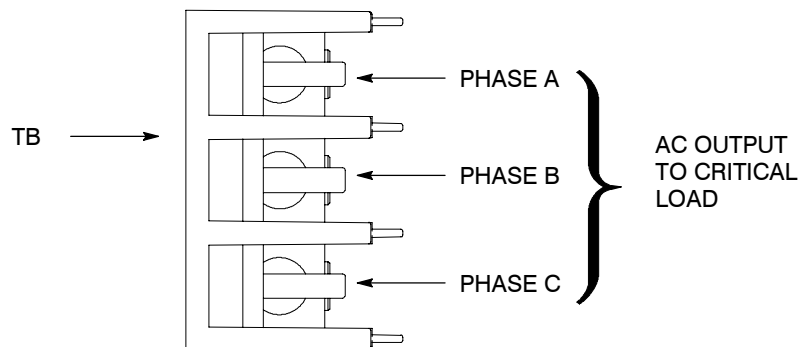
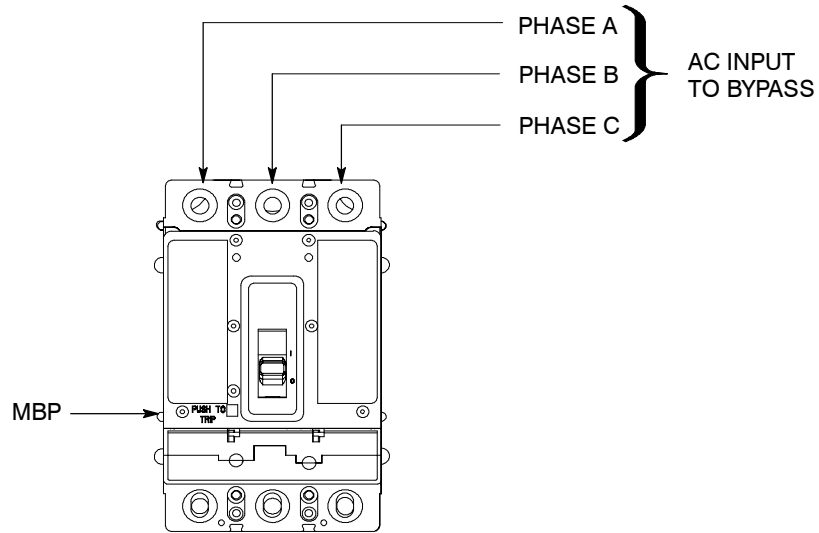

DESCRIPTION: POWER TERMINAL LOCATIONS		
DRAWING NO: 164201546-6	SHEET: 24 of 34	
REVISION: C	DATE: 062806	

120/100, 120/120 KVA, 480/480V MAINTENANCE BYPASS CONFIGURATION INPUT AND LOAD OUTPUT TERMINAL DETAIL

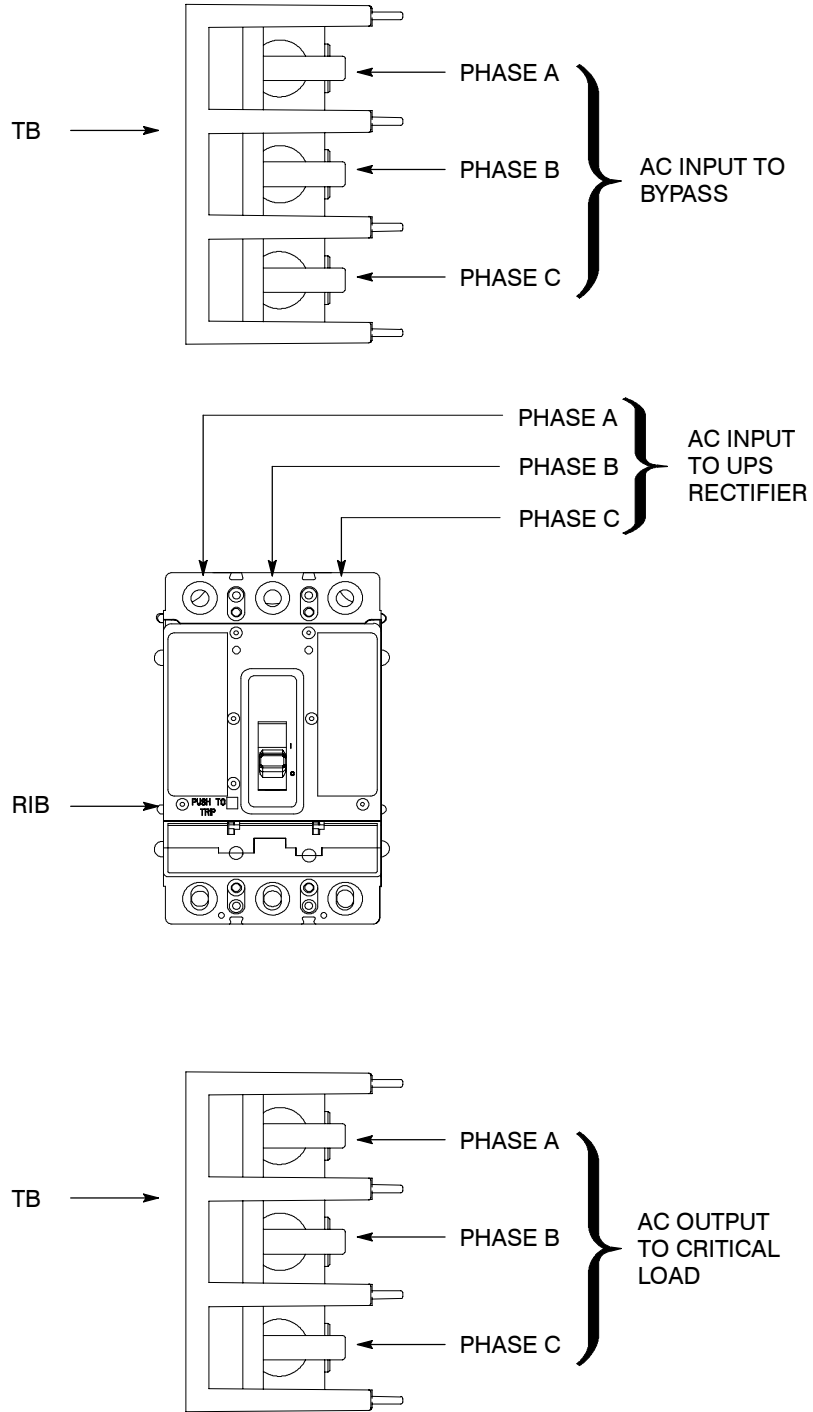

DESCRIPTION: POWER TERMINAL LOCATIONS	
DRAWING NO: 164201546-6	SHEET: 25 of 34
REVISION: C	DATE: 062806

**40/20, 40/30, 40/40 KVA, 208/208V AND
80/40, 80/50, 80/60, 80/80 KVA, 480/480V
UPS SIDECAR MAINTENANCE BYPASS CONFIGURATION
RECTIFIER AND BYPASS INPUT TERMINAL DETAIL**

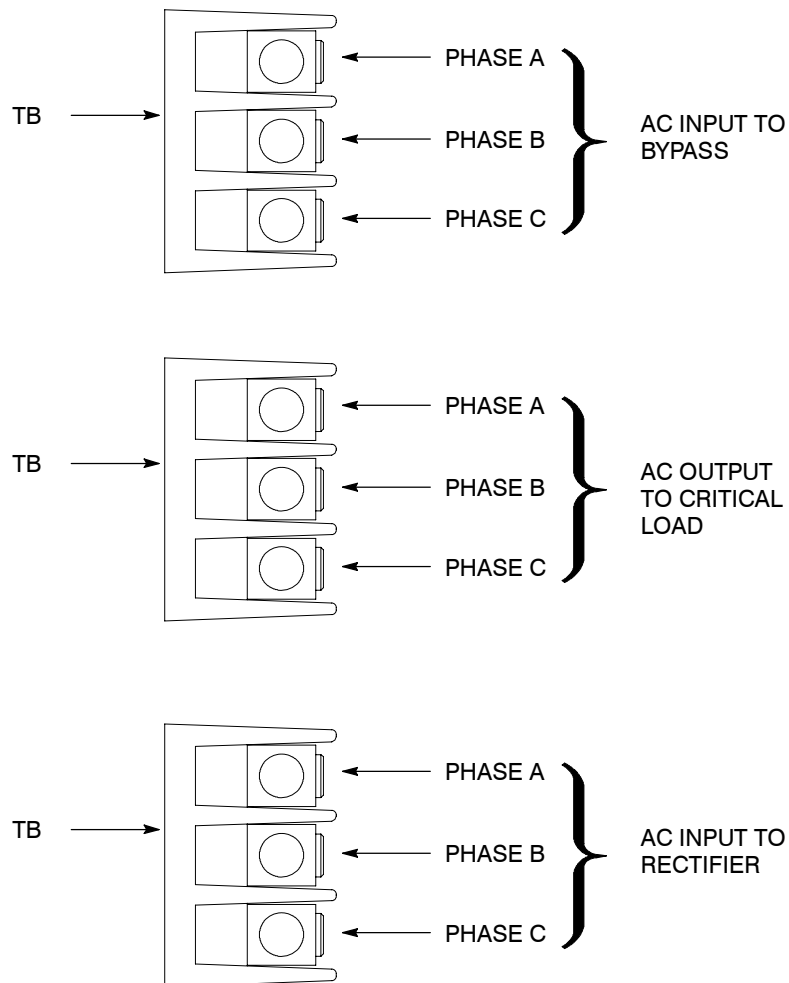

DESCRIPTION: POWER TERMINAL LOCATIONS	
DRAWING NO: 164201546-6	SHEET: 26 of 34
REVISION: D	DATE: 092107

**80/40, 80/50, 80/60, 80/80 KVA, 208/208V AND
160/100, 160/120, 160/160 KVA, 480/480V UPS SIDECAR
MAINTENANCE BYPASS CONFIGURATION
RECTIFIER AND BYPASS INPUT TERMINAL DETAIL**

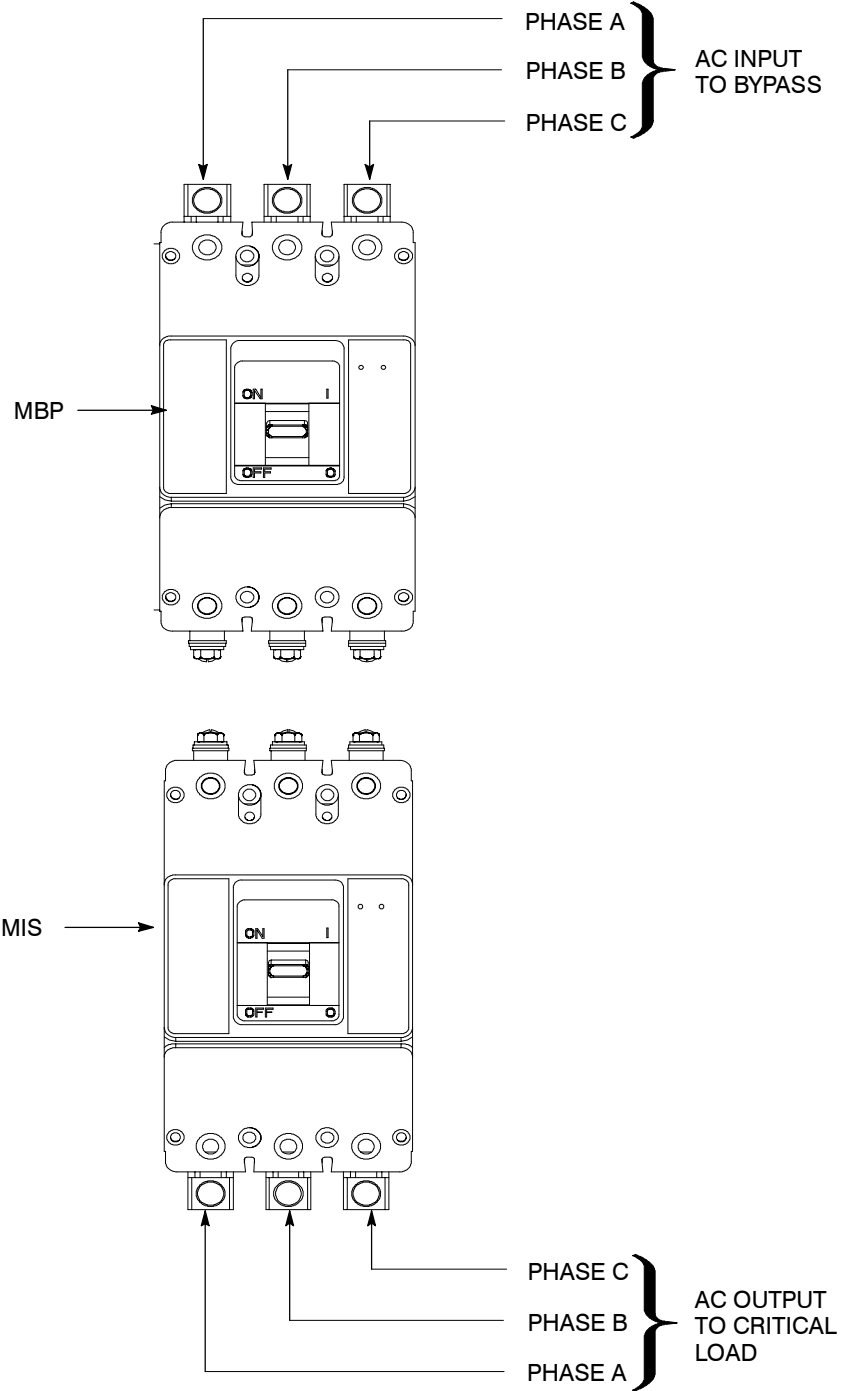

DESCRIPTION: POWER TERMINAL LOCATIONS	
DRAWING NO: 164201546-6	SHEET: 27 of 34
REVISION: C	DATE: 062806

**80/40, 80/50, 80/60, 80/80 KVA, 208/208V AND
160/100, 160/120, 160/160 KVA, 480/480V UPS SIDECAR
MAINTENANCE BYPASS CONFIGURATION
RECTIFIER AND BYPASS INPUT TERMINAL DETAIL**

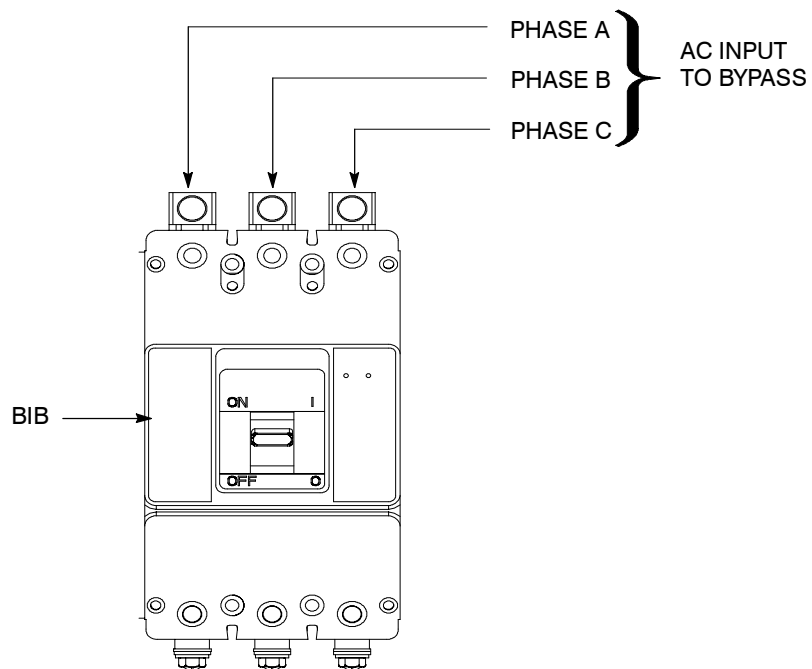
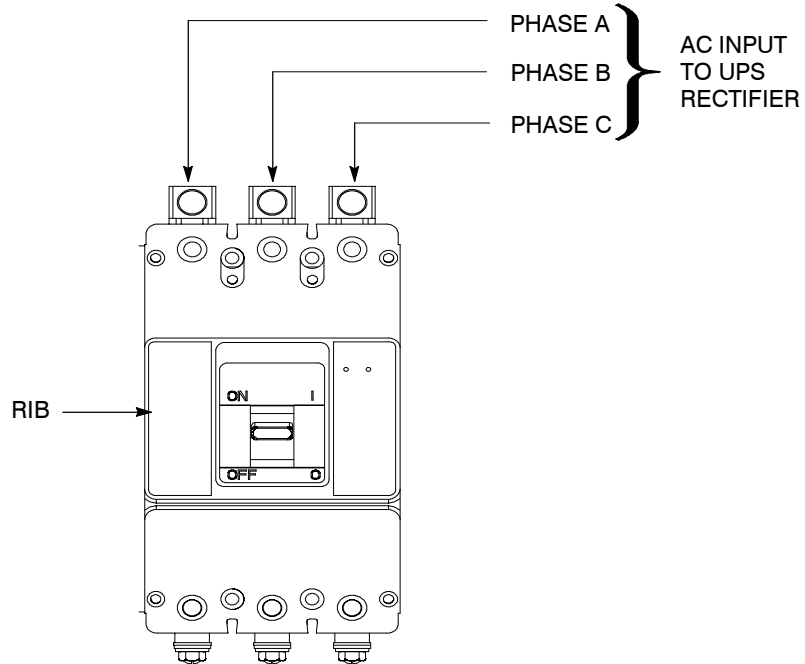

DESCRIPTION: POWER TERMINAL LOCATIONS	
DRAWING NO: 164201546-6	SHEET: 28 of 34
REVISION: C	DATE: 062806

40/20, 40/30, 40/40 KVA, 480/480V UPS SIDECAR PARALLEL REDUNDANT CONFIGURATION MOB INPUT AND LOAD OUTPUT TERMINAL DETAIL

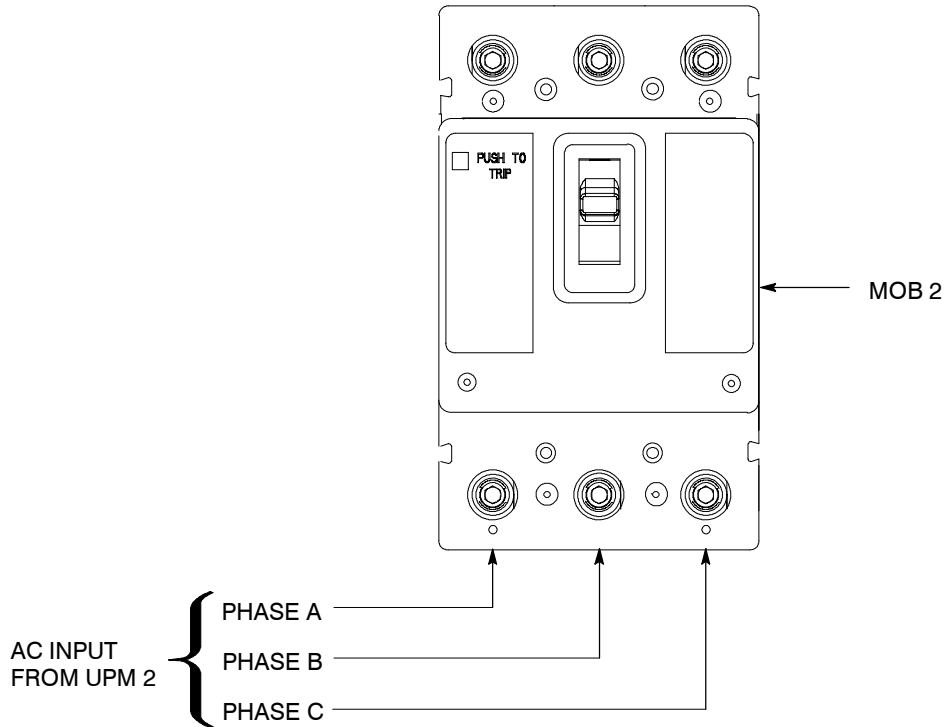
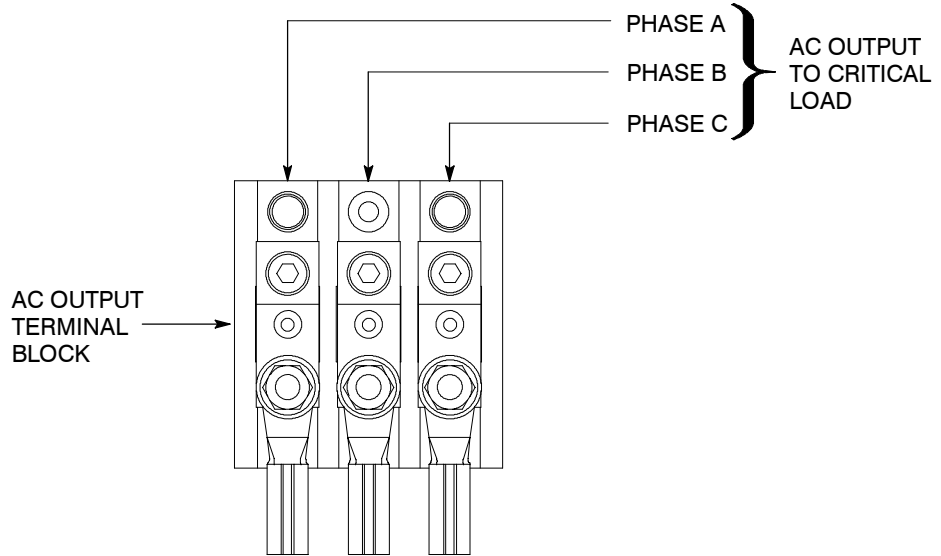

DESCRIPTION: POWER TERMINAL LOCATIONS	
DRAWING NO: 164201546-6	SHEET: 29 of 34
REVISION: D	DATE: 092107

**40/20, 40/30, 40/40 KVA, 208/208V AND
 40/20, 40/30, 40/40 KVA, 480/480V AND
 80/40, 80/50, 80/60, 80/80 KVA, 480/480V AND
 120/100, 120/120 KVA, 480/480V UPS SIDECAR
 PARALLEL REDUNDANT CONFIGURATION
 SLB OUTPUT TERMINAL DETAIL**

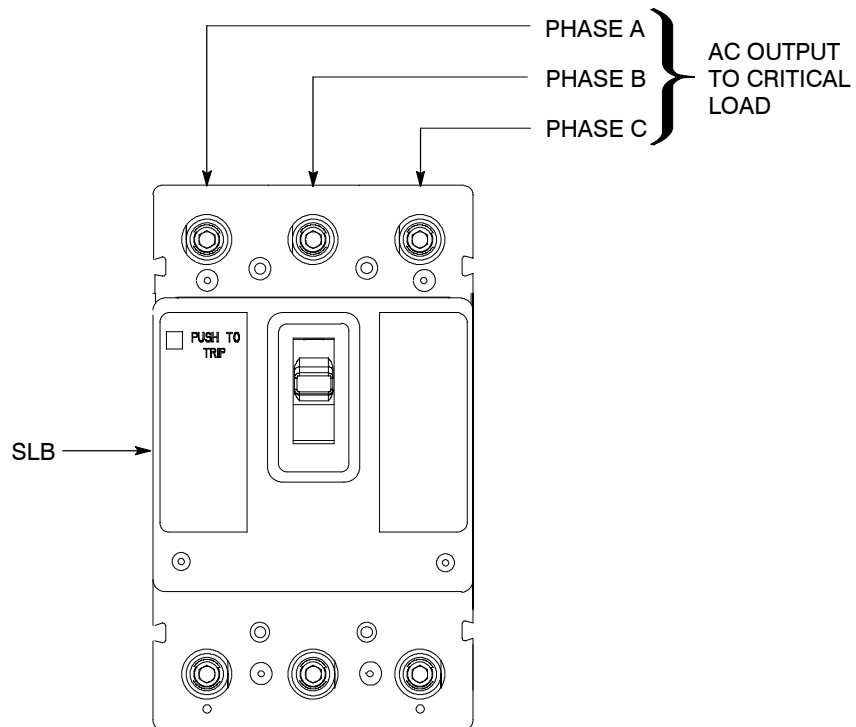

DESCRIPTION: POWER TERMINAL LOCATIONS		
DRAWING NO: 164201546-6	SHEET: 30 of 34	
REVISION: D	DATE: 092107	

**40/20, 40/30, 40/40 KVA, 208/208V AND
80/40, 80/50, 80/60, 80/80 KVA, 480/480V UPS SIDECAR
PARALLEL REDUNDANT CONFIGURATION
MOB INPUT AND LOAD OUTPUT TERMINAL DETAIL**

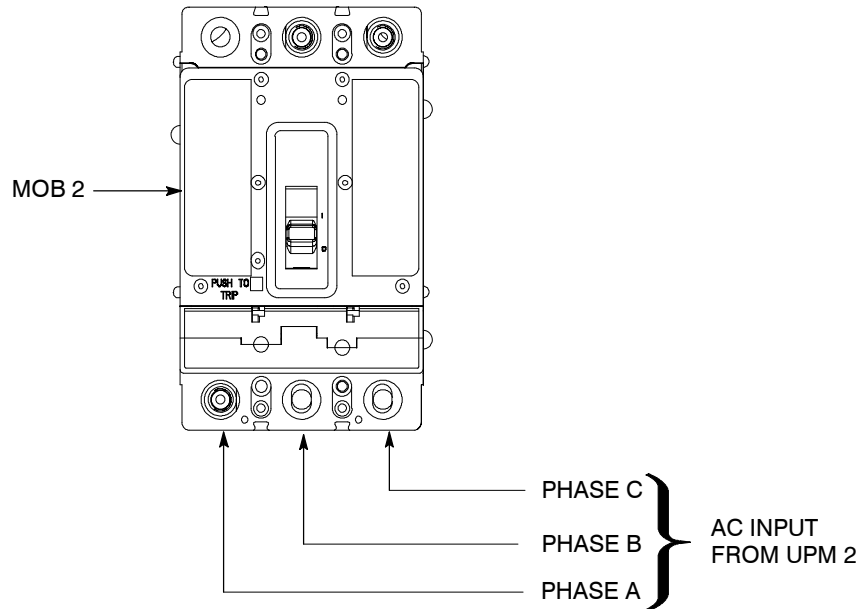
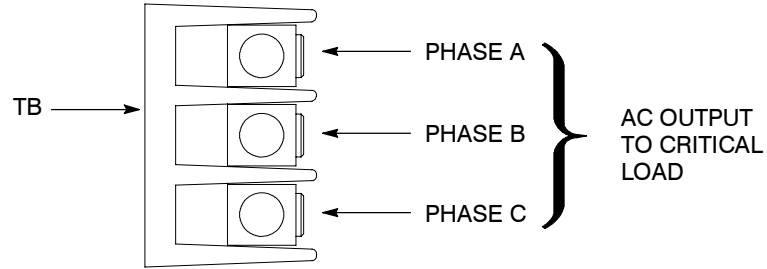

DESCRIPTION: POWER TERMINAL LOCATIONS	
DRAWING NO: 164201546-6	SHEET: 31 of 34
REVISION: D	DATE: 092107

120/100, 120/120 KVA, 480/480V UPS SIDECAR PARALLEL REDUNDANT CONFIGURATION MOB INPUT AND LOAD OUTPUT TERMINAL DETAIL

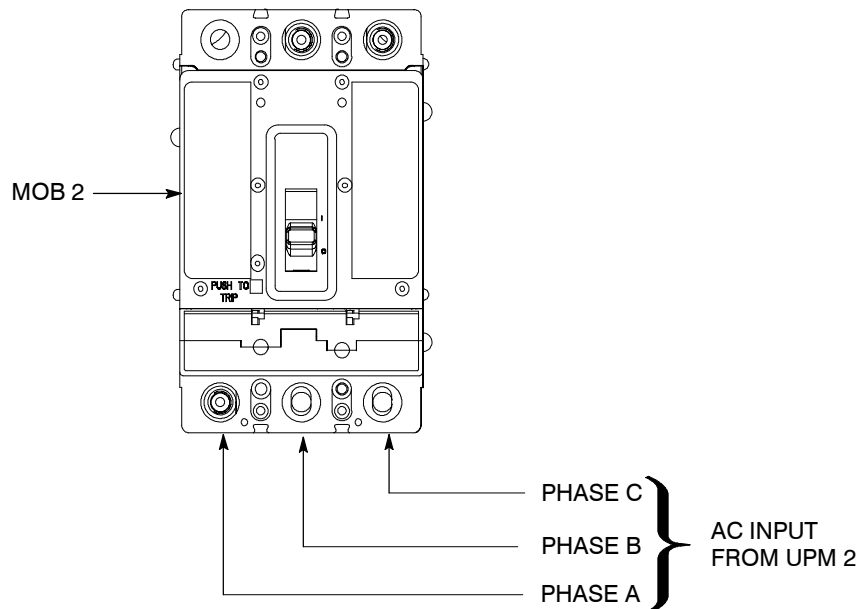
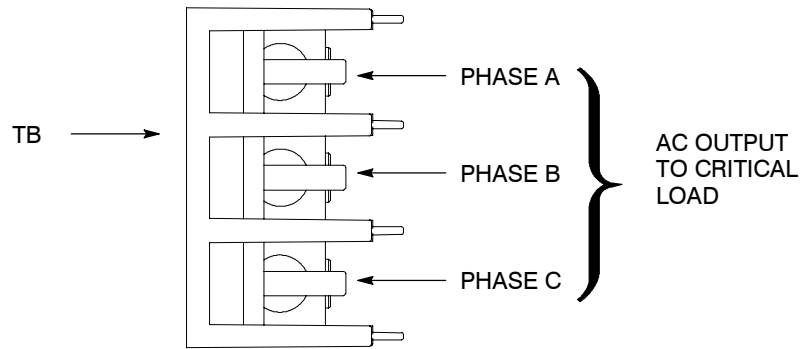

DESCRIPTION: POWER TERMINAL LOCATIONS	
DRAWING NO: 164201546-6	SHEET: 32 of 34
REVISION: C	DATE: 062806

80/40, 80/50, 80/60, 80/80 KVA, 208/208V AND 160/100, 160/120, 160/160 KVA, 480/480V UPS SIDECAR PARALLEL REDUNDANT CONFIGURATION TERMINAL DETAIL

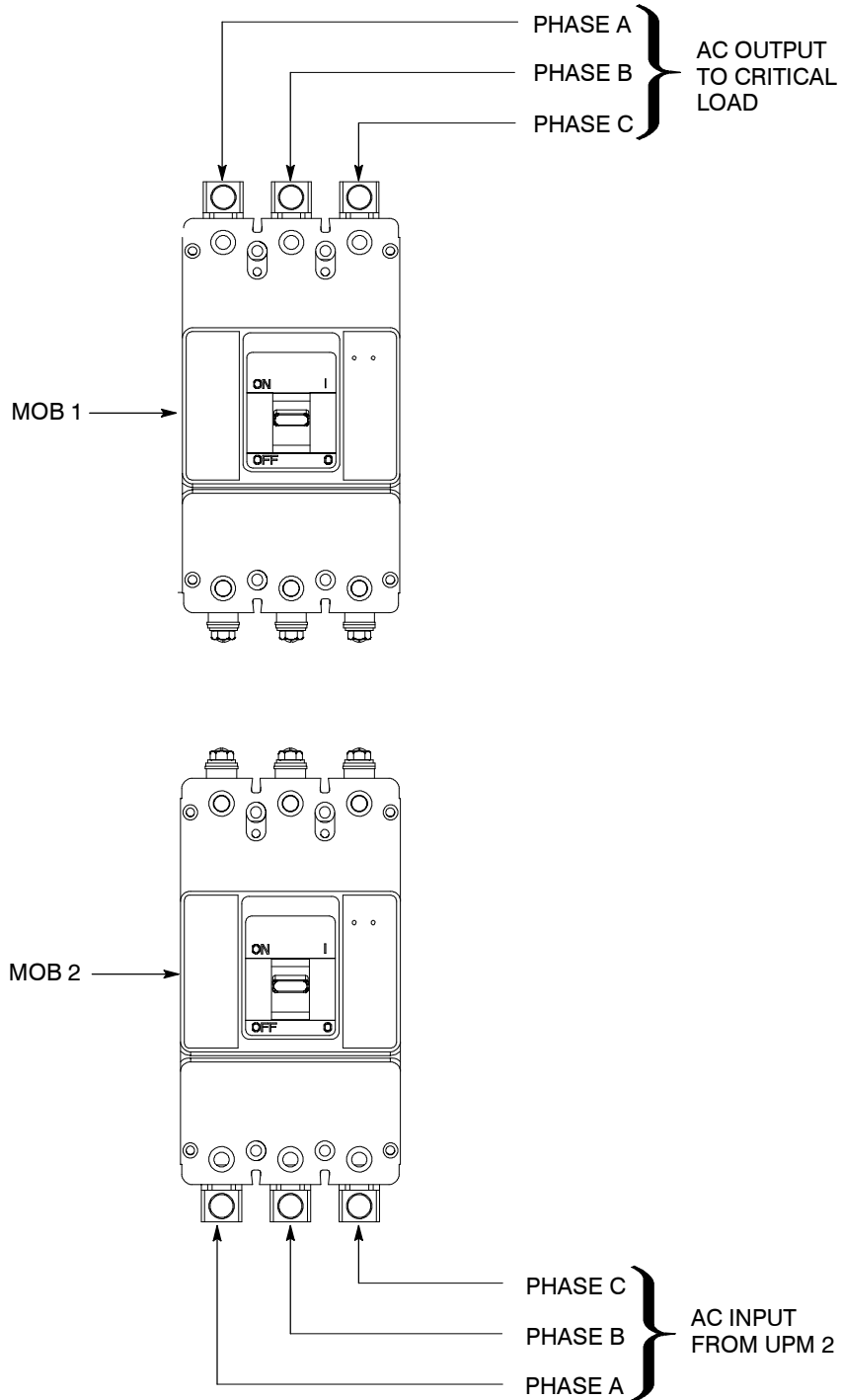

DESCRIPTION: POWER TERMINAL LOCATIONS		
DRAWING NO: 164201546-6	SHEET: 33 of 34	
REVISION: C	DATE: 062806	

**80/40, 80/50, 80/60, 80/80 KVA, 208/208V AND
160/100, 160/120, 160/160 KVA, 480/480V UPS SIDECAR
PARALLEL REDUNDANT CONFIGURATION
SLB OUTPUT TERMINAL DETAIL**

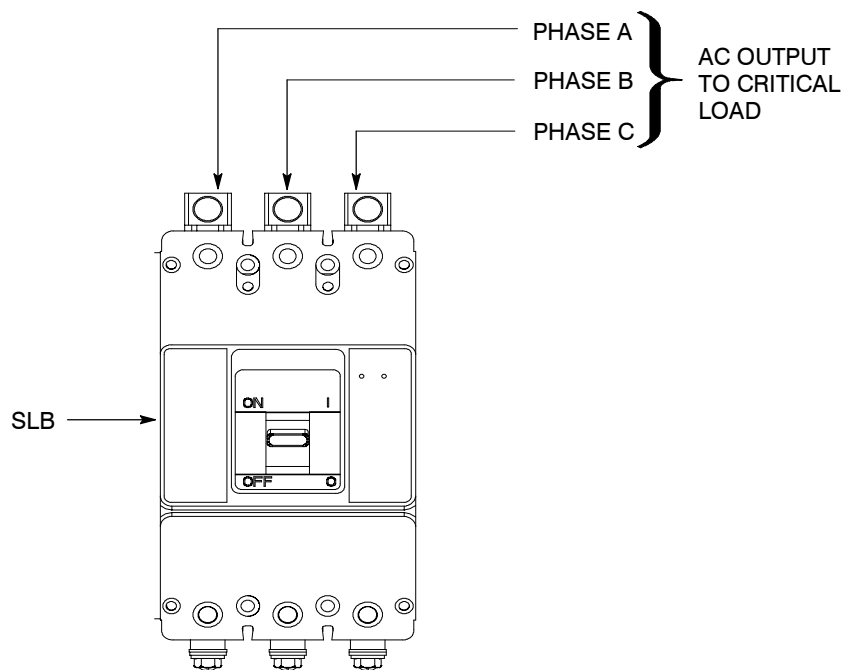

<i>DESCRIPTION:</i> POWER TERMINAL LOCATIONS	
<i>DRAWING NO:</i> 164201546-6	<i>SHEET:</i> 34 of 34
<i>REVISION:</i> C	<i>DATE:</i> 062806

1. Use Class 1 wiring methods (as defined by the NEC) for control wiring. The wire should be rated at 600 volts, 1A minimum and 12 AWG maximum. Use twisted-pair wires for each input and common. All control wiring is customer-supplied.
2. When installing auxiliary contact control wiring between the UPS Sidecar and a remotely located UPM 2 interface terminals, conduit must be installed between the UPM and the UPS Sidecar. Install the control wiring in separate conduit from the power wiring.
3. Alarms display as Building Alarm 1 and Building Alarm 2 on the UPS Control Panel Display Screen, unless the alarms are programmed to display the alarm functional name.
4. Refer to Table R, the following sheets of this drawing, Drawing 164201546-6, sheet 11 of 34 through sheet 20 of 34, and to Chapter 2 for customer interface and control wiring for parallel redundant configurations.

Table R. TB1 Terminals – 1+1 Parallel Redundant Configuration		
<i>UPS Sidecar Terminal TB1</i>	<i>Name</i>	<i>Description</i>
1	Not Used	
2	Not Used	
3	MOB 1 Aux 1 Contact NC	Contacts used to indicate whether UPS Sidecar MOB 1 is closed. Contacts are open when MOB 1 is closed.
4	MOB 1 Aux 1 Contact Common	
5	MOB 1 Aux 2 Contact NO	Contacts used for backup control (pull chain) for parallel operation.
6	MOB 1 Aux 2 Contact Common	
7	MOB 2 Aux 1 Contact NC	Contacts used to indicate whether UPS Sidecar MOB 2 is closed. Contacts are open when MOB 2 is closed.
8	MOB 2 Aux 1 Contact Common	
9	MOB 2 Aux 2 Contact NO	Contacts used for backup control (pull chain) for parallel operation.
10	MOB 2 Aux 2 Contact Common	

<i>DESCRIPTION:</i> INTERFACE AND CONTROL WIRING INSTALLATION NOTES AND TERMINAL LOCATIONS	
<i>DRAWING NO:</i> 164201546-7	<i>SHEET:</i> 1 of 4
<i>REVISION:</i> D	<i>DATE:</i> 063006

UPS SIDECAR TERMINAL TB1 FOR PARALLEL REDUNDANT CONFIGURATIONS

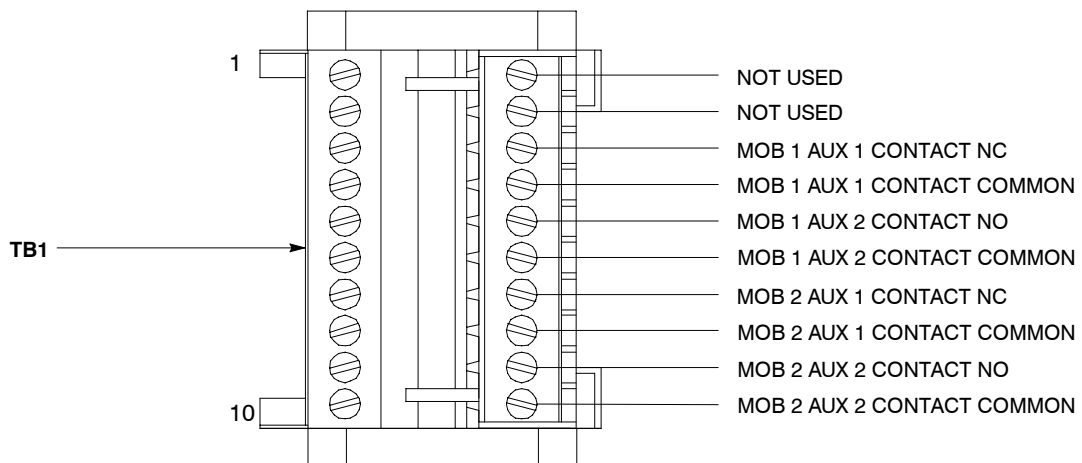

NOTE 1. Alarm displays as Building Alarm 2 on the UPS Control Panel Display Screen, unless the alarms are programmed to display the alarm functional name.

2. Use twisted-pair wires for each alarm input and common.

DESCRIPTION: INTERFACE AND CONTROL WIRING INSTALLATION NOTES AND TERMINAL LOCATIONS	
DRAWING NO: 164201546-7	SHEET: 2 of 4
REVISION: D	DATE: 063006

BackUp Control (Pull Chain) Wiring Terminations	
From	To
UPM 1 TB2-1 (Bldg Alm 2)	UPS Sidecar TB1-5 (MOB 1 Aux 2 NO)
UPM 2 TB2-1 (Bldg Alm 2)	UPS Sidecar TB1-9 (MOB 2 Aux 2 NO)
UPM 1 TB2-2 (Bldg Alm Common)	UPM 2 TB2-2 (Bldg Alm Common)
UPS Sidecar TB1-6 (MOB 1 Aux 2 Common)	UPS Sidecar TB1-10 (MOB 2 Aux 2 Common)
UPM 1 TB2-1 (Bldg Alm 2)	UPM 1 TB2-3 (Byp)
UPM 1 TB2-2 (Bldg Alm 2 Common)	UPM 1 TB2-4 (Byp Common)
UPM 2 TB2-1 (Bldg Alm 2)	UPM 2 TB2-3 (Byp)
UPM 2 TB2-2 (Bldg Alm 2 Common)	UPM 2 TB2-4 (Byp Common)

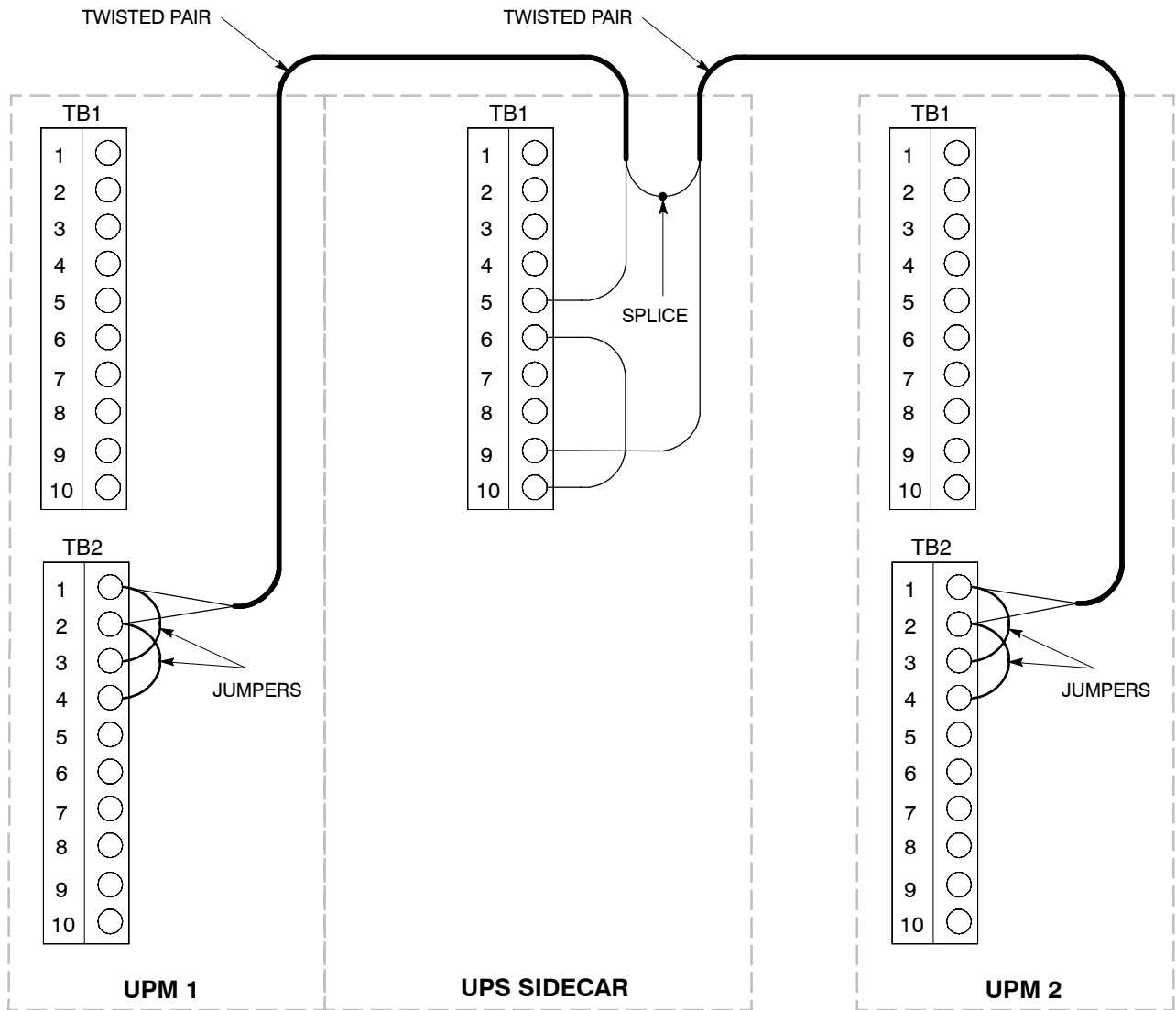

**1+1 PARALLEL REDUNDANT
CONFIGURATION
BACKUP CONTROL
(PULL CHAIN) WIRING**

DESCRIPTION: INTERFACE AND CONTROL WIRING INSTALLATION NOTES AND TERMINAL LOCATIONS	
DRAWING NO: 164201546-7	SHEET: 3 of 4
REVISION: D	DATE: 063006

Module Output Breaker Monitoring Wiring Terminations	
From	To
UPM 1 Can Bridge Card J3-1 (Bldg Alm)	UPS Sidecar TB1-3 (MOB 1 Aux 1 NC)
UPM 1 Can Bridge Card J3-2 (Bldg Alm Common)	UPS Sidecar TB1-4 (MOB 1 Aux 1 Common)
UPM 2 Can Bridge Card J3-1 (Bldg Alm)	UPS Sidecar TB1-7 (MOB 2 Aux 1 NC)
UPM 2 Can Bridge Card J3-2 (Bldg Alm Common)	UPS Sidecar TB1-8 (MOB 2 Aux 1 Common)

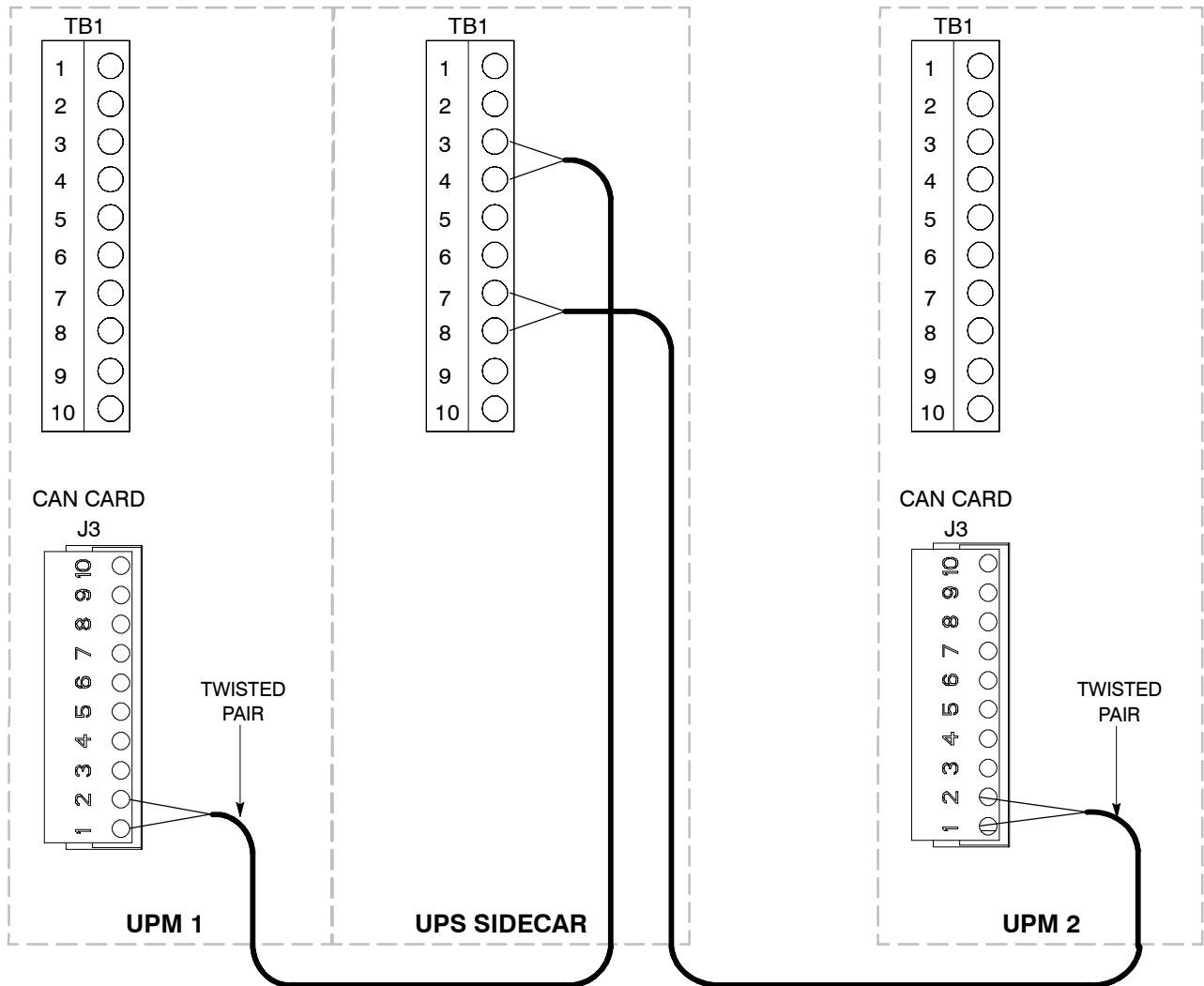

**1+1 PARALLEL REDUNDANT
CONFIGURATION
MOB MONITORING WIRING**

DESCRIPTION:	INTERFACE AND CONTROL WIRING INSTALLATION NOTES AND TERMINAL LOCATIONS	
DRAWING NO:	164201546-7	SHEET: 4 of 4
REVISION:	D	DATE: 063006

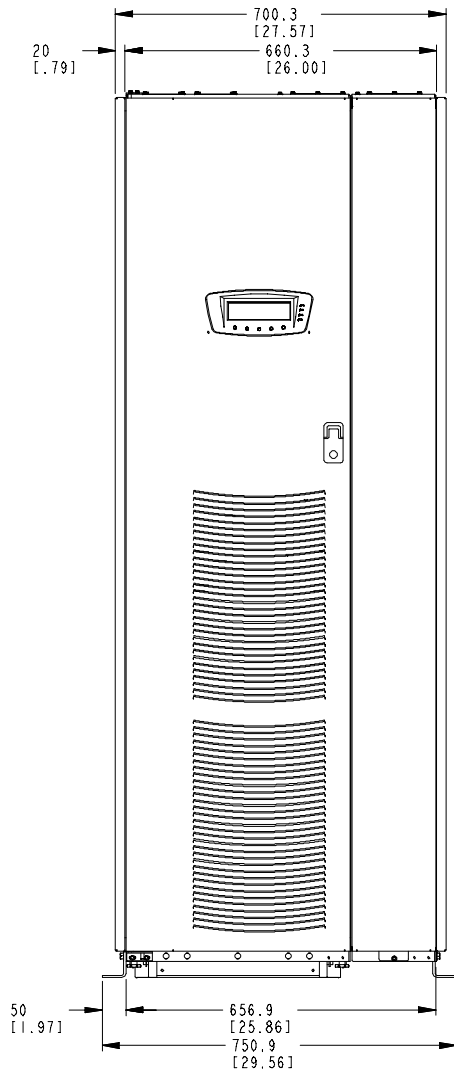

FRONT VIEW

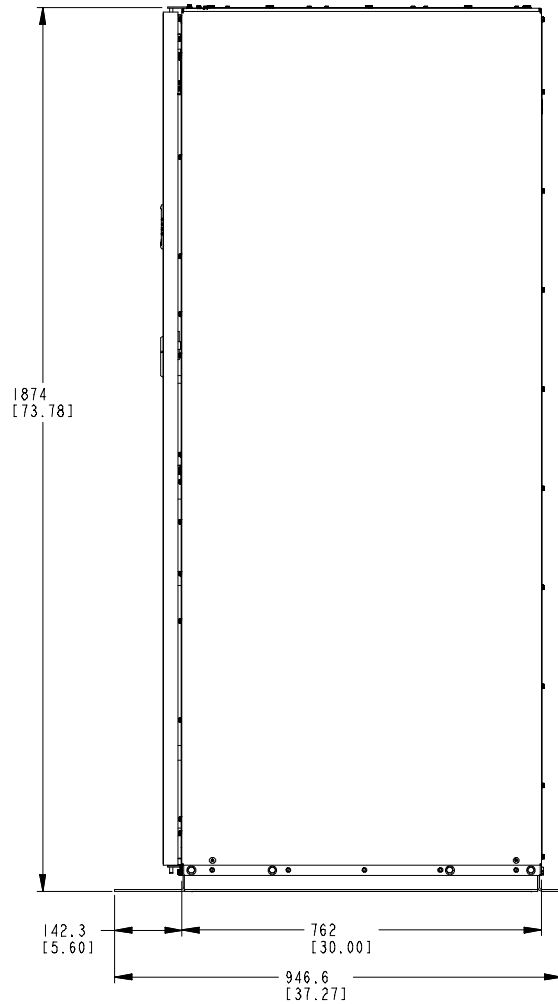

RIGHT SIDE VIEW

40 kVA and 80 kVA UPS WITH SIDECAR

Dimensions are in millimeters [inches]

DESCRIPTION: UPS SIDECAR DIMENSIONS	
DRAWING NO: 164201546-8	SHEET: 1 of 4
REVISION: B	DATE: 092107

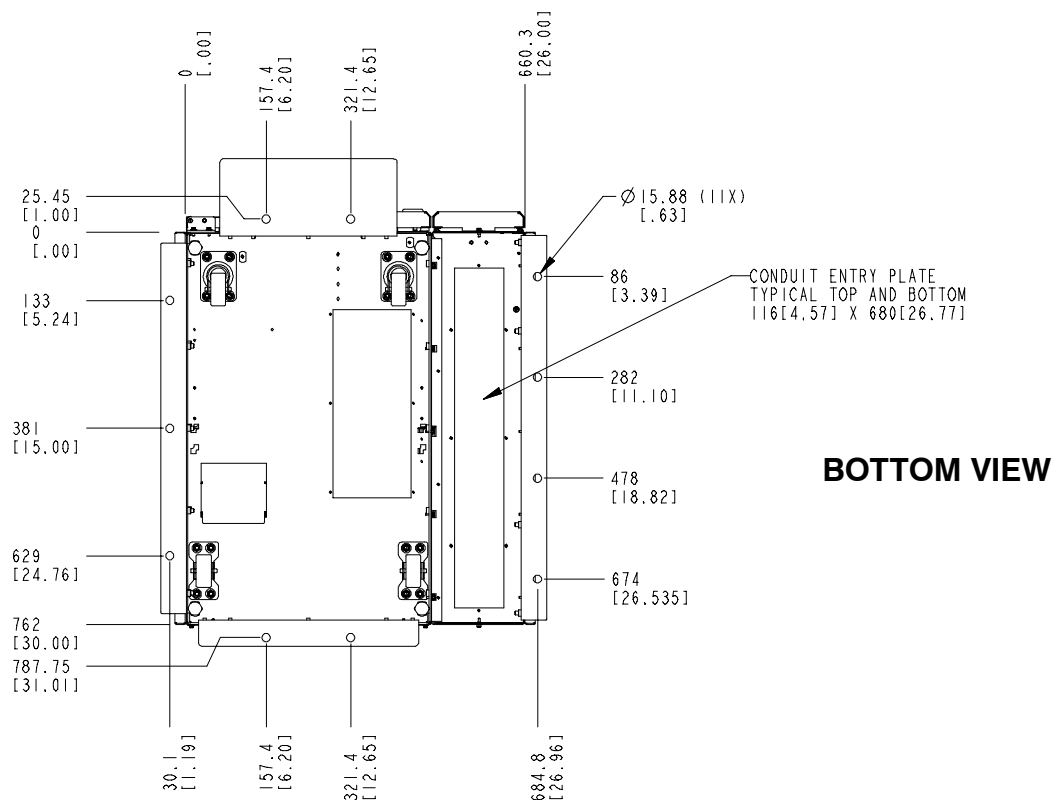
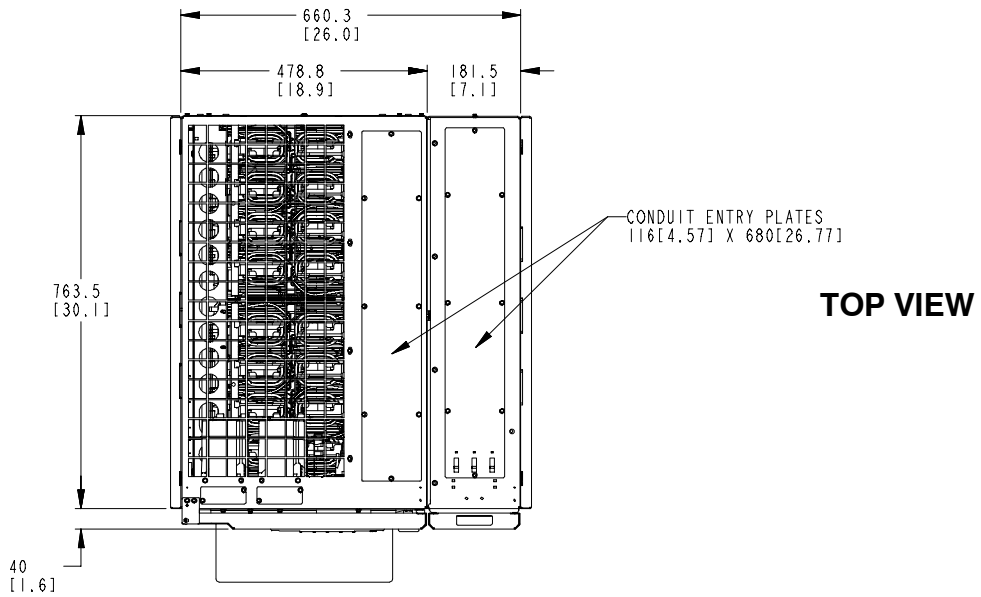

**40 KVA AND 80 KVA UPS
WITH SIDECAR**

DESCRIPTION: UPS SIDECAR DIMENSIONS	
DRAWING NO: 164201546-8	SHEET: 2 of 4
REVISION: B	DATE: 092107

Dimensions are in millimeters [inches]

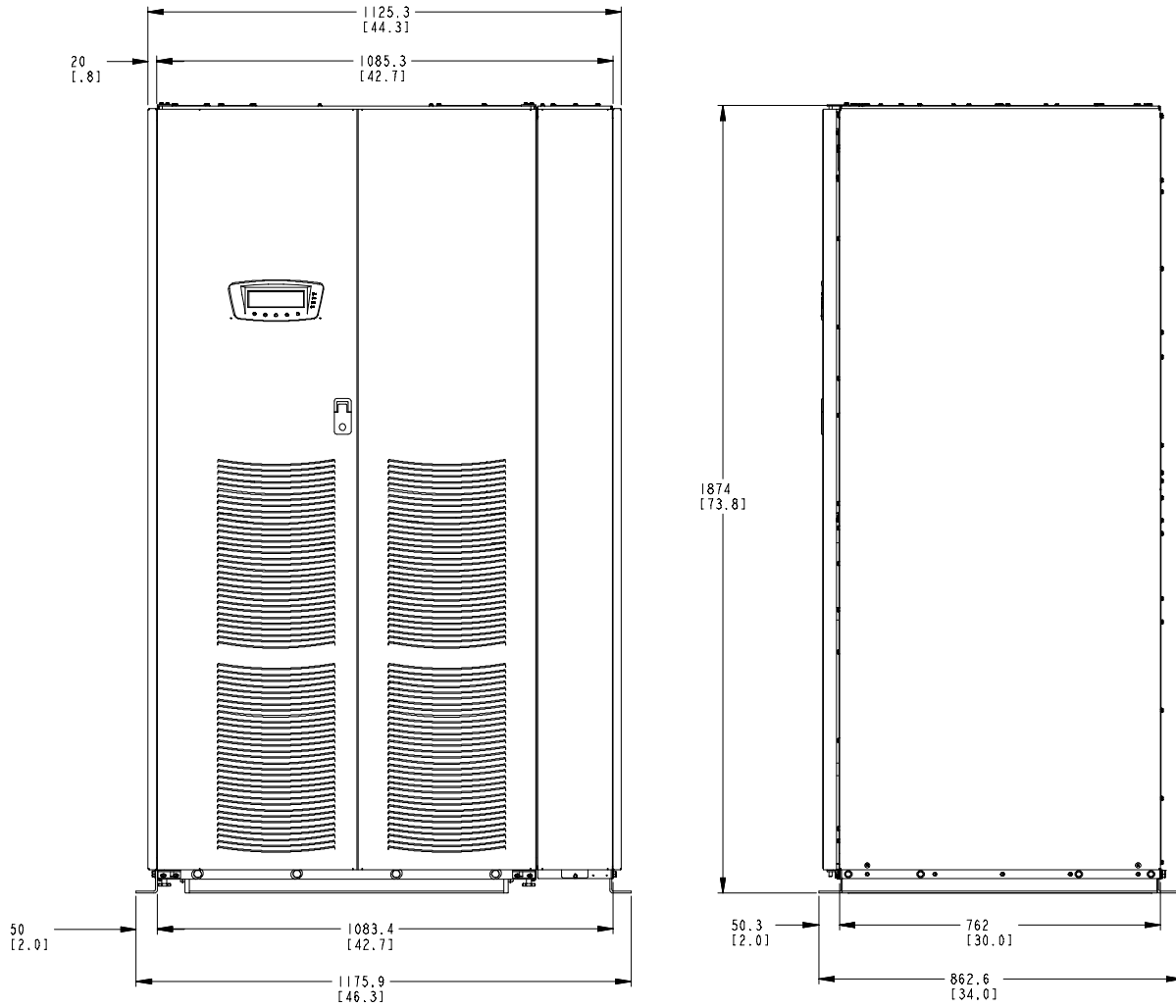

FRONT VIEW

RIGHT SIDE VIEW

120 KVA AND 160 KVA UPS WITH SIDECAR

DESCRIPTION: UPS SIDECAR DIMENSIONS		
DRAWING NO: 164201546-8	SHEET: 3 of 4	
REVISION: A	DATE: 031505	

Dimensions are in millimeters [inches]

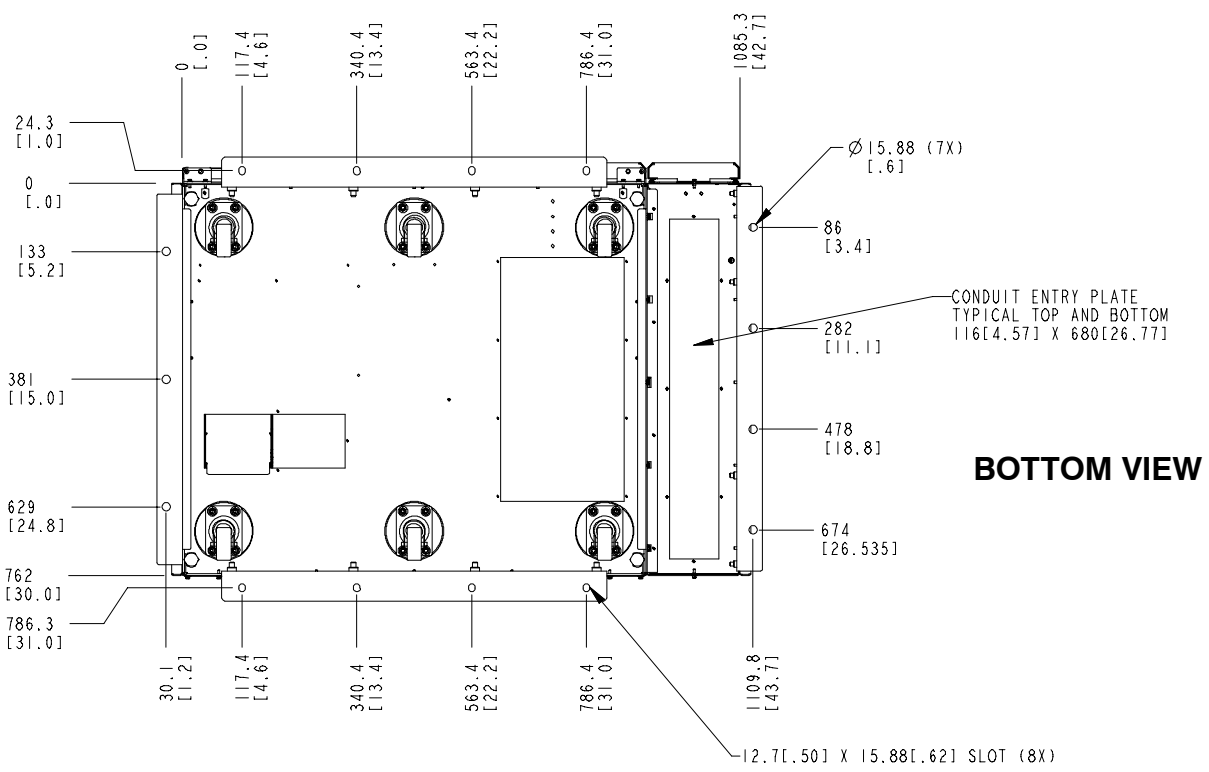
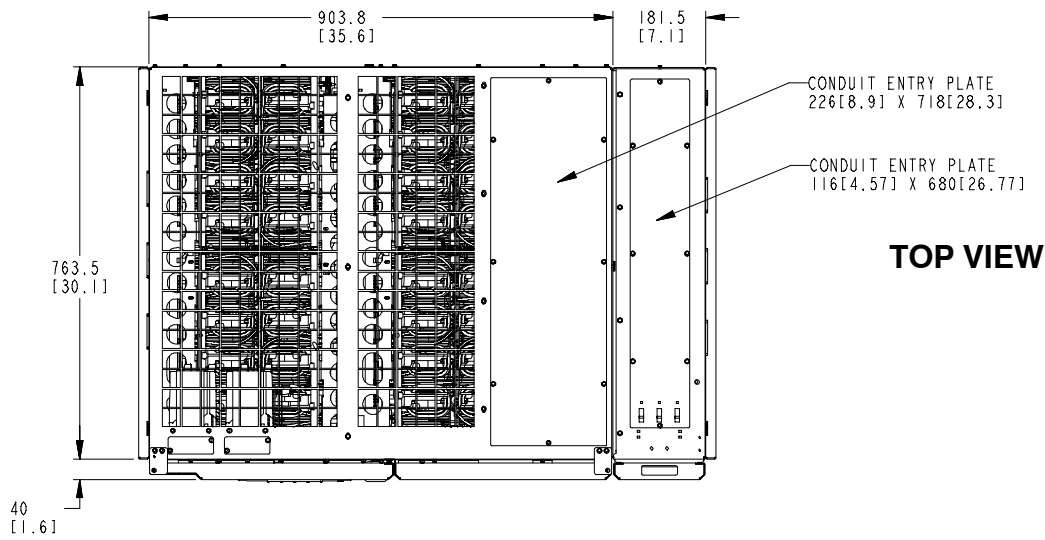

**120 KVA AND 160 KVA UPS
WITH SIDECAR**

DESCRIPTION: UPS SIDECAR DIMENSIONS	
DRAWING NO: 164201546-8	SHEET: 4 of 4
REVISION: A	DATE: 031505

Dimensions are in millimeters [inches]

This page intentionally left blank.



164201586 E

Free Manuals Download Website

<http://myh66.com>

<http://usermanuals.us>

<http://www.somanuals.com>

<http://www.4manuals.cc>

<http://www.manual-lib.com>

<http://www.404manual.com>

<http://www.luxmanual.com>

<http://aubethermostatmanual.com>

Golf course search by state

<http://golfingnear.com>

Email search by domain

<http://emailbydomain.com>

Auto manuals search

<http://auto.somanuals.com>

TV manuals search

<http://tv.somanuals.com>