

PCX
POWER CLASS PRO COMPETITION AMPLIFIERS

OWNER'S MANUAL

PCX 250

PCX 280

PrecisionPower 9235 South McKerny Street, Tempe, Arizona 85284 www.precisionpower.com
8900-4005

NOTES

FEATURES

NEW! Advanced Instrumentation Input Stage.
NEW! 12dB/Octave; HP/LP/FULL; 30-4kHz Crossover.
NEW! Independent Line Output Crossover 30-4kHz.
Adaptive PWM Power Supply.
Triple Darlington Output Stage.
AP-IV Protection Circuitry.
Forced Air Thermal Management. (PCX 280)
QBASS™ Bass Boost (PCX 250)
QBASS Plus™ Bass Boost. (PCX 280)
High Voltage Input Capability with -12dB Attenuation Switch.
Gold Plated RCA Input and Output Connectors.
PowerLock™ Speaker and Power Wire Connectors.
Mixed Mono/Stereo Operation.
3-Yr Warranty when installed by an Authorized *PrecisionPower* Dealer.

SPECIFICATIONS

Power Bandwidth	10 Hz - 50 kHz
Total Harmonic Distortion	< 0.02 %
S/N Ratio	> 110dB
Input Topology	Instrumentation
Input Sensitivity	150mv - 12 Volts RMS
Input Impedance	10k Ohms
Load Impedance (stereo)	2 - 8 Ohms
Load Impedance (bridged)	4 - 8 Ohms
Supply Voltage	11 - 15 Volts
Damping Factor	>500
Slew Rate	>50 V/μS
QBASS™	Up to +12dB Boost @ 40Hz
QBASS PLUS™	Up to +18dB Boost @ 30, 36, 44, or 60Hz
Crossovers	12dB/Octave
Crossover Frequency	30-4kHz
Idle Current:	PCX 250 1.5 Amps PCX 280 2 Amps

POWER RATINGS

<u>MODEL</u>	<u>4ohm STEREO</u>	<u>2ohm STEREO</u>	<u>4ohm MONO</u>
PCX 250	2 X 50	2 X 100	1 X 200
PCX 280	2 X 80	2 X 160	1 X 320

* ALL POWER RATINGS SHOWN ARE TESTED @ 12V; 20-20kHz

BLOCK DIAGRAM

PCX250

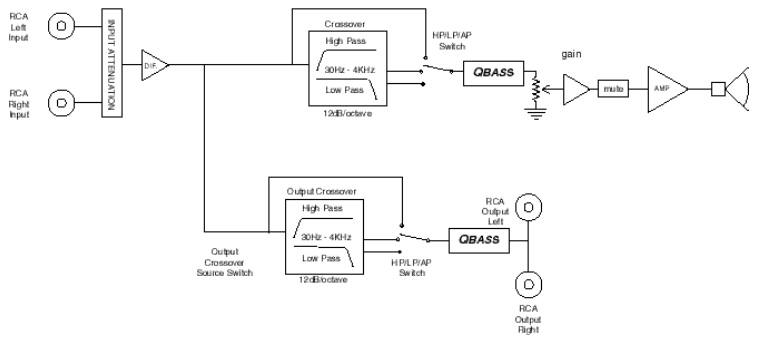

PCX280

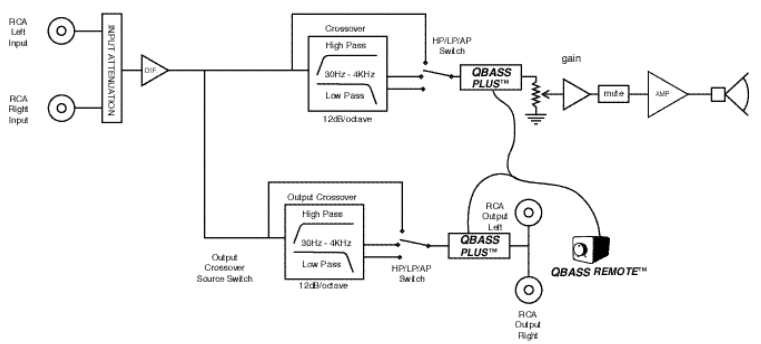

TOOLS/PARTS FOR INSTALLATION

NOTE: TOOLS ARE NOT SUPPLIED

- Small flat blade screwdriver
- Phillips screwdriver (#2 or medium sized)
- Wire cutters
- Wire strippers

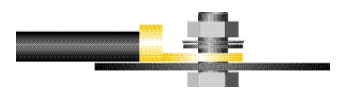

- 4 - #6 round head screws, and 1 - #8 sheet metal screw (or nut, bolt, flat washer star washer) [see detail]
- 2 - Ring connectors (large enough to accommodate your method of grounding)
- In-line fuse or circuit breaker - see fuse chart below
- Power and ground wire - see Power Wire Calculator on page 4
- Speaker wire - 12 to 16 gauge
- Grommets (sized to work with the power wire you plan to use in your installation)
- Tube of silicone sealant

FUSE REQUIREMENTS

You will need to install an in-line fuse or circuit breaker in the power wire within 18" of the battery. This fuse or circuit breaker is to protect your vehicle from fire in case the power wire shorts to the vehicle body. If you are only using one amplifier, use the fuse rating indicated in this chart. If you are using more than one amplifier, add up the fuse ratings for all the amplifiers. This sum is the rating for your main fuse or circuit breaker. You may also want to add a power distribution block near your amplifiers to distribute large gauge power cable to multiple amplifiers.

Amplifier	Maximum Fuse Rating
PCX 250	30 Amp
PCX 280	35 Amp

SYSTEM DESIGN #1

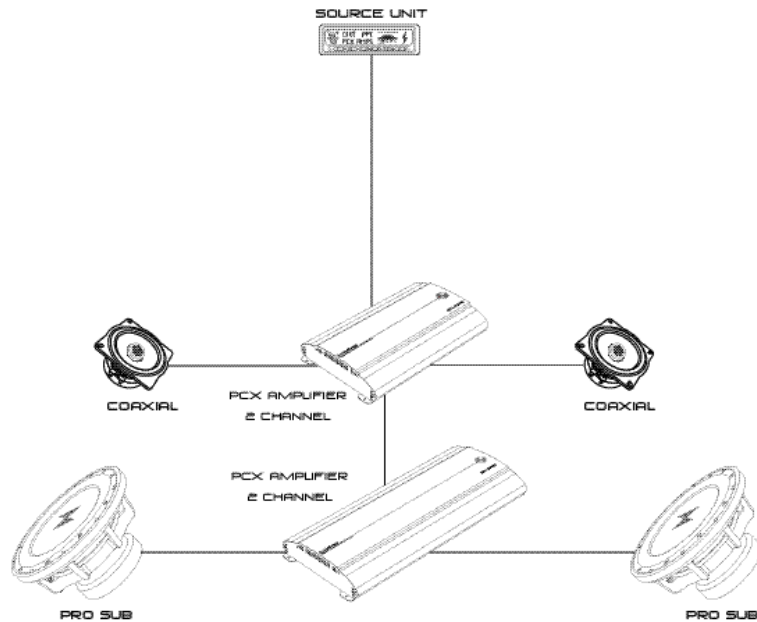

16

WIRING

Before beginning, disconnect the negative (-) terminal of the battery prior to working on the positive (+) terminal to prevent a short to ground. This is important, unless you want to spend the rest of your life with a nickname like "Sparky," or "Smokey." Reconnect the negative terminal only after all connections have been made.

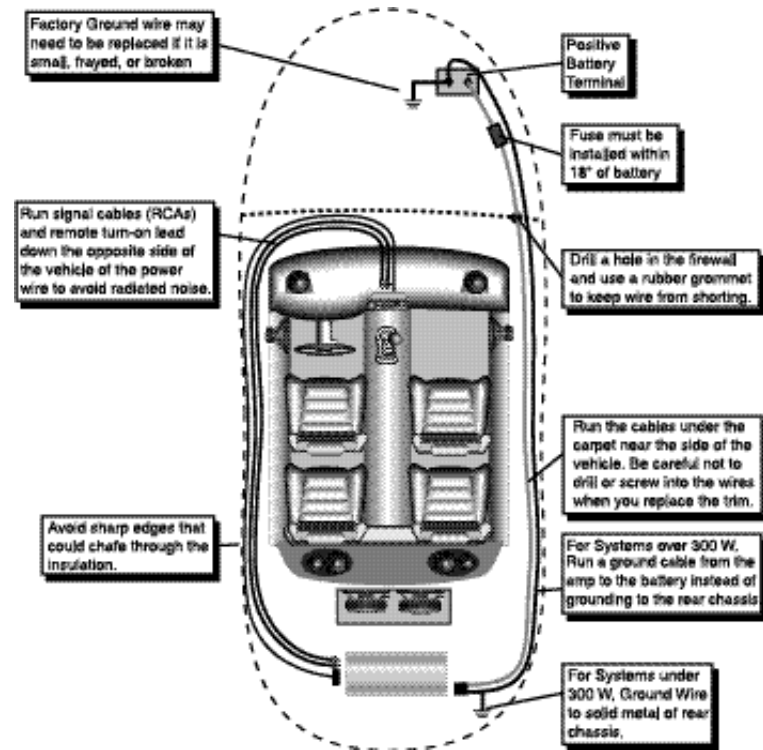

Warning! A Main Fuse must be installed within 18" of battery!

5

TROUBLE SHOOTING

NO SOUND

Is the LED lit?

YES

NO

Check Power and Remote turn-on wire for voltage. Make sure Ground wire is secure.

STILL NO SOUND

See your Authorized *PrecisionPower* Dealer or call 1-800-62POWER.

SOUND IN ONE CHANNEL ONLY

Reverse left and right speakers by unplugging the speaker connector, turning it over and plugging it back in.

SOUND IS NOW IN

OPPOSITE CHANNEL

Reverse RCA inputs

SAME CHANNEL

Problem is in the speaker or speaker wire of the silent channel

SOUND IS NOW IN

OPPOSITE CHANNEL

Reverse RCAs at head unit

SAME CHANNEL

Problem is in the Amplifier. See your local Authorized *PrecisionPower* Dealer or call 1-800-62POWER.

SOUND IS NOW IN

OPPOSITE CHANNEL

Problem is in the head unit or before the amplifier

SAME CHANNEL

Problem is in the RCA cables

AP-IV PROTECTION CIRCUIT

Short Circuit Protection engaged: The amplifier will turn off and try to come back on immediately. The amplifier will cycle like this indefinitely, with "blips" of sound each time. If this is the case, check your speakers and wiring for low impedance and short circuits.

Thermal Protection engaged: The amplifier will turn off and several minutes later will come back on. In this case, ensure that there is nothing blocking the normal convective airflow of the amplifier. No obstruction should be within 2" of the amplifier on all sides.

NOTE: Low battery voltage will cause the amplifier to run warmer and possibly damage the amplifier.

14

POWERLOCK CONNECTORS

Once you have run both the power and ground wires, it's time to connect the cables to the amplifier. Cut off excess wire and, using wire strippers, strip the ends of the power and ground cables approximately 1/4 inch. Locate the *PowerLock* power and ground connector (supplied). With a small flat bladed screw driver, loosen the screws before attempting to insert the cables. Insert the wires into the appropriate hole, and tighten the screws. Check for stray strands of wire which may short out. Once the wires are secure, the *PowerLock*™ may be plugged into the amplifier. The Power/Ground *PowerLock*™ will accommodate 6 gauge wire for the *PCX 250* and *PCX 280*.

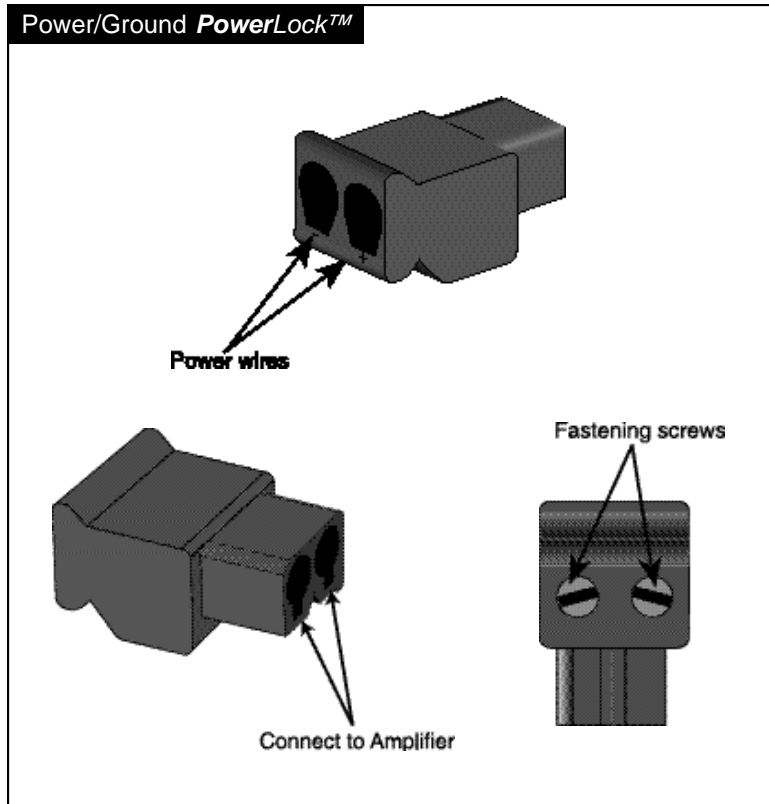

7

TCX CROSSOVER

Your **New! PCX™** amplifier has a **TC-X Crossover (Total Control X-over®)** 30-4kHz (See page 19 for crossover Detent Chart). 12dB per octave phase correlated crossover built in to provide superior system flexibility without the added expense and installation of an outboard crossover. The speaker outputs of your amplifier are high-pass, low-pass, or all-pass depending to the HP/LP/Full switch on the front endplate. You would choose low pass (switch middle) to use this amp for subwoofers, choose high pass (switch left), or full (switch right) to use this amp for full range speakers.

The RCA outputs are controlled by a separate HP/LP/Full switch, and are always independent of the speaker output crossover. As well as being able to independently select HP/LP/Full, your new **PCX™** amplifier allows independent selection of frequencies from 30-4kHz (See page 19).

NOTE: The System Diagrams beginning on page 15 show several ways to use the virtually unlimited **PCX™** amplifiers internal crossovers in your system.

ADJUSTING INPUT GAIN

1. Adjust all amplifier input gain controls to just above minimum sensitivity (fully counterclockwise).
2. Using the cleanest music source (CD) playing, turn up the head unit source volume until you can hear distortion. Now turn it down a bit until you cannot hear the distortion (*usually* just below full volume).
3. Increase the Amplifier gain (clockwise) until the onset of audible distortion. Then decrease the gain to the point just before the distortion starts. This setting minimizes background noise and prevents overload.
4. Repeat step 3 for any remaining amplifiers in the system.



12

ENDPLATE DIAGRAM

1. **Cooling Plenums:** Maintain a minimum 2" clearance around cooling plenums for proper amplifier cooling.
2. **Crossover HP/LP/FULL Select Switch:** Adjust this switch to select the HPF/LPF/FULL function for the speaker outputs.
3. **Crossover Frequency Selector Control:** Use this control to adjust the crossover frequency for the speaker output. (See Crossover frequency chart pg.19)
4. **RCA Inputs:** Connect the RCA cables from source unit, or line driver to these RCA connectors.
5. **Gain Control:** Use this control to match the output level of the source-unit to the input of the amplifier.
6. **-12dB Input Attenuation:** Push this switch 'IN' for high voltage input (4V-12V) capability. This button pushed 'IN' must be used for speaker level input on common ground head-units or for high voltage line drivers.

PCX 250, 280 Control Panel

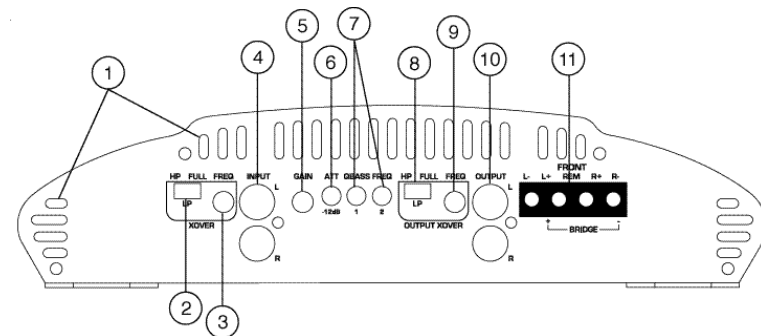

7. **QBASS™ Frequency Control:** Buttons 1 and 2 offer the capability of selecting 30, 36, 44, or 60Hz to boost by the **QBASS™** Control. (See page #2)
8. **Output Crossover HP/LP/FULL Select Switch:** Adjust this switch to select the HP/LP/FULL function for the RCA outputs.
9. **Output Crossover Frequency Knob:** Use this control to adjust the crossover frequency for the RCA output. (See Crossover frequency chart pg.19)
10. **RCA Outputs:** Left and right RCA outputs provide HP/LP/Full; 30-4kHz to another amplifier.
11. **Speaker Output Connections:** Plug the speaker **PowerLock™** connector in here.

9

SPEAKER WIRING

Run the speaker wires from the amplifier location through the vehicle to the speakers. Observe the same precautions for routing these wires that you followed for running the power and remote turn-on wires. Cut off excess and, using wire strippers, strip 1/4 inch of insulation. Locate the speaker/remote turn-on *PowerLock* connector. Loosen the outer screws on the underside of the connector. Insert the speaker leads into the end. Check to be sure you've maintained proper polarity before securing each wire, and plug the *PowerLock* into the amplifier.

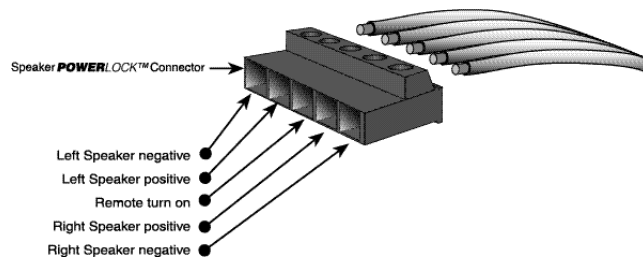

AMPLIFIER BRIDGING

All two-channel *PCX™* amplifiers are capable of being bridged into a 4 ohm mono output without switches or bridging modules. This feature permits the creation of a mono channel for a subwoofer or center channel. Deriving the mono channel is accomplished by using the Left Channel Positive wire (**L+**) as the positive speaker wire and the Right Channel Negative wire (**R-**) as the negative speaker wire.

NOTE: It is important that a minimum 4 ohm impedance is observed. If the impedance drops below 4 ohms while the amplifier is wired in the bridged configuration, the amplifier's protection circuitry (**AM-IV**) may engage.

10

INPUTS

There are two sets of RCA jacks on the front end of your amplifier. The RCA cables from your source unit go in the set labeled **INPUTS**. If your source unit doesn't have RCA outputs don't worry. Simply add a set of RCA plugs (available at your dealer) to your front or rear set of speaker leads (see drawing below), plug them into the input jacks, and push to the **IN** the **-12dB** input attenuation switch.

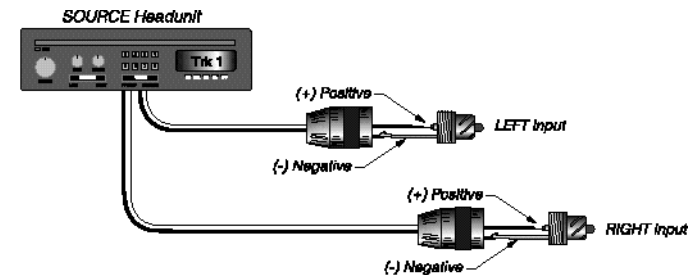

ADVANCED INSTRUMENTATION INPUT

The *Advanced Instrumentation Input* has trickled down from the \$15,000 *PrecisionPower2500F1*. This circuit completely isolates the chassis ground from the audio circuit of the amplifier and reduces noise radiated into your signal cables by up to 40dB. This is equivalent to a noise reduction of approximately one hundred times what the noise level would be without this circuitry. It provides all the benefits of a true 'balanced' line without the need of any special cables (see diagram below). This type of input works with any conventional RCA cable.

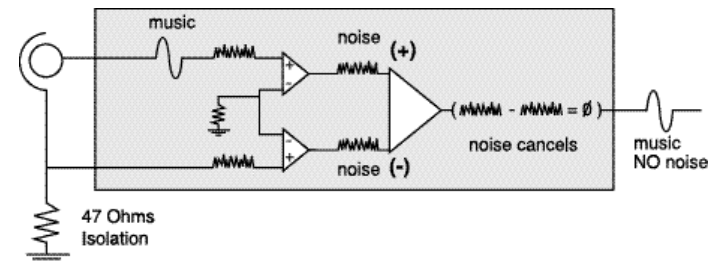

11

REAR ENDPLATE

PCX 250 Power Panel

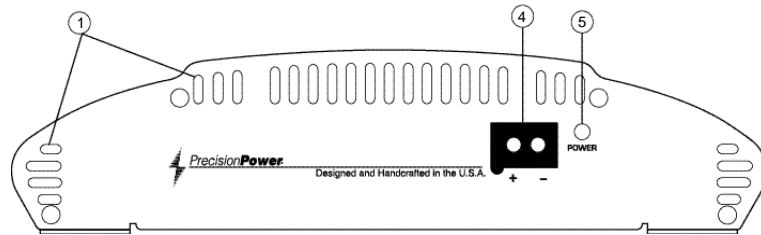

- 1. Cooling Plenums:** Maintain a minimum 2" clearance around cooling plenums for proper amplifier cooling.
- 2. QBASS™ Control:** Add more bass to the system by turning this control clockwise to boost the selected **QBASS™** frequency up to 18dB.
- 3. QBASS™ Remote Port:** Port to plug in the optional **QBASS Plus™** Remote knob.
- 4. Power & Ground Connections:** After connecting the power and ground cables to the **PowerLock™** wire connector, plug it in here.
- 5. Power Indicator:** A green light indicates that the amplifier power is ON.

PCX 280 Power Panel

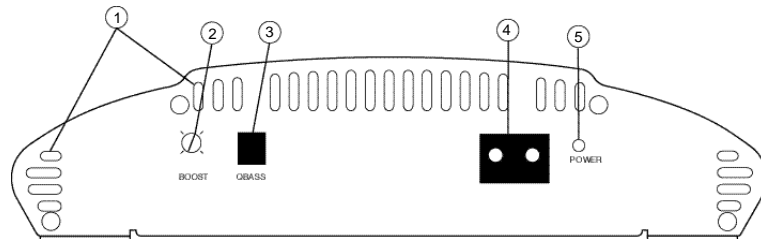

8

HIGH MASS INTERNAL HEATSINK

The **New! PCX™** amplifiers mass has been increased by 2 lbs. per linear foot over last year's **POWERCLASS™** amplifiers, resulting in far superior heat dissipation. The unique heatsink on your **PCX™** amplifier has been designed with fins on the inside of the aluminum extrusion. This allows for the transfer of heat from the circuitry to the heatsink fins and out through the vents in the endplates. Be sure you have ample space around the amplifier for cooling; at least 2" on all sides.

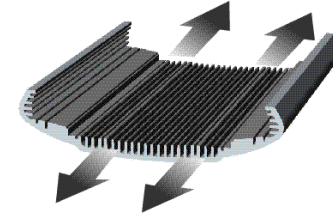

FORCED AIR THERMAL MANAGEMENT

To manage the additional heat associated with higher output capability, a thermally controlled fan has been designed into the **PCX 280**. When the heatsink temperature reaches a pre-determined value, the fan is activated and cool air is drawn in through the lower intake vents on the endplate. This cool air flows below the circuit board, through the fan and across the internal fins, cooling the heatsink. The warm air is then forced out through the upper endplate exhaust vents.

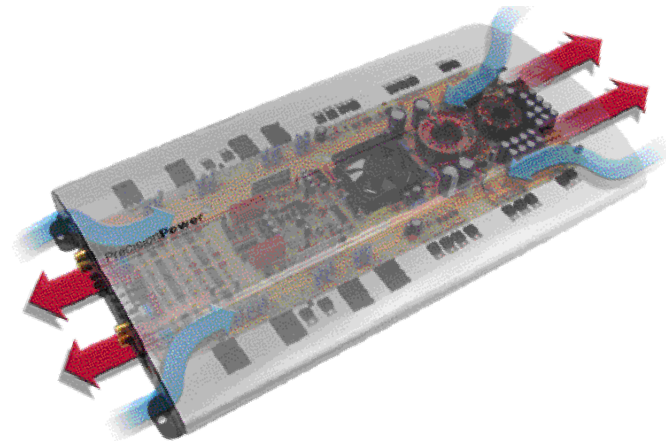

13

GROUND WIRING

Locate an area near the amplifier(s) that is metal and clean an area about the size of a quarter to bare metal. Inspect the area around and underneath to be sure you won't drill into wires, brake or fuel lines, etc. Drill a pilot hole in the middle of this area. Terminate the ground wire with a ring connector and attach it to the bare metal using a #8 sheet metal screw and washer or preferably, a bolt, nut and a star washer (**not supplied**). We suggest crimping and soldering this connection. After the connection is complete, coat the area (*on both sides*) with silicone or some similar material to prevent rust from developing on the bare metal. If your grand total current draw is over 50 amps (*or total output power is over 300 watts*), you should run a separate ground wire beside your power wire from the battery to the amplifier(s). Keep the ground and power wires as close together as possible, and use the same gauge wire for both. This will ensure that you have a good ground path, and may eliminate such potential problems as engine noise and overheated amplifiers.

CHARGING SYSTEM

If your grand total current draw is over 100 amps (*or total output power is over 600 watts*), you are probably exceeding the capability of your charging system. Dimming lights and fluctuating voltage are solid indicators that you need to upgrade your alternator, battery, or both. Keep in mind that your amplifiers simply convert electrical energy to acoustical energy, and any electrical deficiency will compromise the performance of your sound system. For more information about charging system upgrades, see your local authorized *PrecisionPower* Dealer or call *PrecisionPower* Technical Support at **1-800-62POWER x 229**.



6

MIXED MONO OUTPUT

The ability to run stereo speakers while simultaneously running a mono output from the same amplifier is accomplished by running the stereo speakers normally and tapping into the appropriate wires for the "mixed mono" channel (left channel positive for the positive speaker wire and right channel negative for the negative speaker wire). Speaker impedance should be no lower than 2 Ohms on the stereo channels and 4 ohms on the mono channel.

NOTE: Passive crossovers must be used for "mixed mono" operation. Choose a low pass crossover around 100Hz for your subwoofer, then choose a high pass crossover for your stereo channels. The high pass crossover must be at the same or slightly higher frequency than the low pass crossover to maintain the correct impedance. See your *PrecisionPower* dealer or call **1-800-62POWER** for more information about passive crossovers.

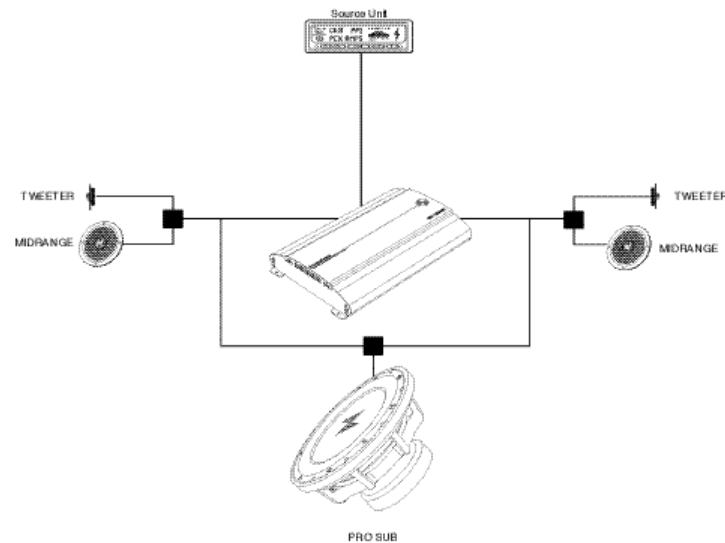

15

WIRING

The following is a basic formula to be used as a guide to determine current draw. A50% amplifier efficiency rating is used as an average. Your new **PCX™** amplifier is more efficient than most other amplifiers. This formula is to be used as a guideline. Using wire of a larger gauge can only improve the current transfer of your system. Do not use smaller gauge wire.

Total Amplifier RMS output x 2 = Total Input Wattage from car

Total Input Wattage = $\frac{\text{Current Draw (in Amps)}}{\text{Supply Voltage}}$

Example: A **POWERCLASS™ PCX 280** amplifier has two channels at 80w per channel RMS rating into 4 Ohms (80 x 2 = 160).

You would use the formula in the following way:

$$160W \times 2 = 320W$$

$$\frac{320W}{12V} = 26.6 \text{ Amps Total current draw.}$$

If the same amplifier is driven into a 2 Ohm stereo or 4 Ohm mono load, double it's 4 Ohm RMS rating. All **POWERCLASS™** amplifiers will effectively double their power at this load.

$$160W \times 2 \times 2 = 640W$$

$$\frac{640W}{12V} = 53.3 \text{ Amps Total current draw.}$$

If you are using more than one amplifier, add up the total current draw for all of them and choose the appropriate gauge based on the grand total.

POWER WIRE CALCULATOR

Recommended Minimum Gauge

Total Current Draw (in amps)	Length Of Wire To Be Run							
	Up to 4ft.	4 to 7ft.	7 to 10ft.	10 to 13ft.	13 to 16ft.	16 to 19ft.	19 to 22ft.	22 to 28ft.
25-50	10	10	8	8	6	6	4	4
50-65	8	8	6	4	4	4	4	2
65-85	6	6	4	4	2	2	2	0
85-105	6	6	4	2	2	2	2	0
105-125	4	4	4	2	2	0	0	0
125-150	2	2	2	2	0	0	0	00
150-200	0	0	0	0	00	00	00	000
200-250	00	00	00	000	000	000	000	0000

NOTE: The ground wire must be the same gauge or larger as the power wire.

SYSTEM DESIGN #2

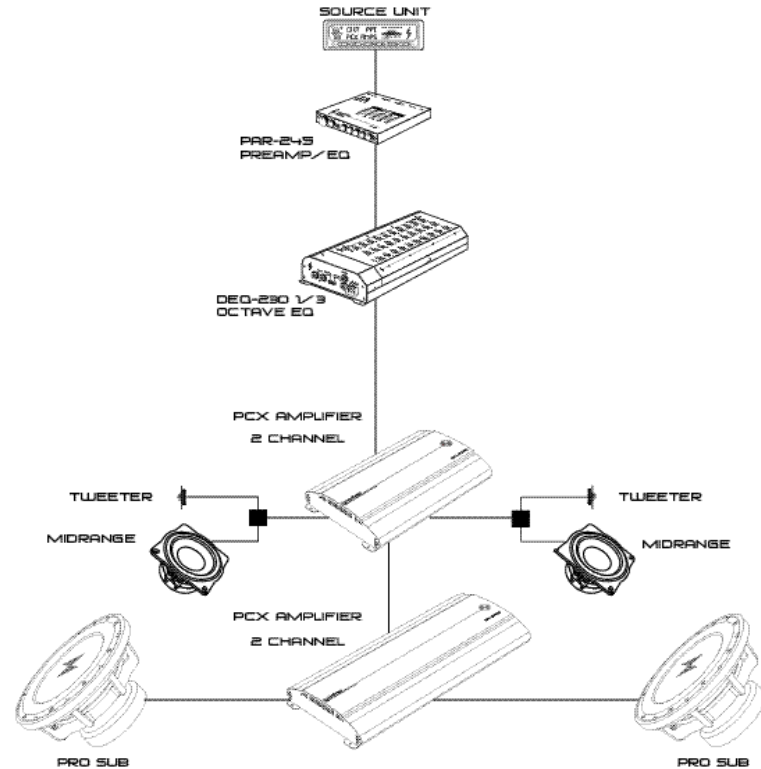

Q BASS™

QBASS™ (PCX 250)

Up to 12dB of Boost centered at 40Hz, with a Q-Factor of 2.

Q BASS PLUS™

QBASS Plus™ (PCX 280)

Up to 18dB of Boost with selectable center frequency at 30Hz, 36Hz, 44Hz or 60Hz, with a Q-Factor of 2.

Optional QBASS REMOTE™ (PCX 280)

This boost control can be mounted in the dash and will supersede the boost control on the amplifier endplate.

Q BASS™ Settings		
1	2	Freq.
IN	IN	30Hz
IN	OUT	36Hz
OUT	IN	44Hz
OUT	OUT	60Hz

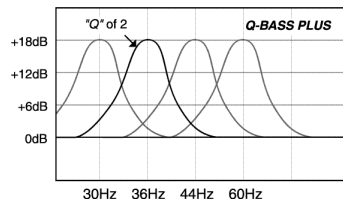

Optional QBASS REMOTE™: This boost control can be mounted in the dash and will supersede the boost control on the endplate.

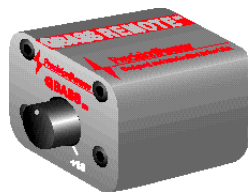

PrecisionPowerPCX™ amplifiers no longer need an optional QPORT™ to connect multiple QBASS PLUS™ equipped amplifiers while using one QBASS REMOTE™. The new QBASS PLUS™ circuitry in the PCX™ amplifiers is now positioned before the crossover circuit. In doing this, PrecisionPower engineers have allowed you to daisy chain your RCAoutput to the next amplifier input, causing the first amplifier's Q BASS Remote™ to become the master control amplifier. See your Authorized PrecisionPower Dealer for more information! (See diagram pg.18)

2

CROSSOVER DETENT CHART

Detent #	Low Pass Frequency (Hz) @ -3dB	High Pass Frequency (Hz) @ -3dB
1	28	52
2	28	52
3	30	52
4	30	56
5	30	56
6	32	60
7	34	64
8	36	72
9	38	76
10	42	80
11	46	88
12	50	92
13	52	100
14	54	116
15	60	132
16	66	148
17	76	168
18	88	192
19	100	216
20	116	244
21	136	284
22	144	348
23	168	404
24	198	468
25	240	512
26	286	564
27	310	624
28	340	700
29	380	800
30	424	932
31	484	1036
32	576	1144
33	632	1300
34	748	1504
35	932	1812
36	1076	2196
37	1428	2840
38	1700	4116
39	2436	4540
40	2830	4728
41	2980	4728

19

CONGRATULATIONS

And thank you for choosing **PrecisionPower** audio equipment. At **PrecisionPower** we proudly design, engineer and manufacture audio products at our production facilities. Our award winning engineering team utilizes innovative technology to consistently deliver *Absolutely State of the Art*™ performance, sound quality, reliability, and value. This **PrecisionPower** product reflects our commitment to offer you unparalleled versatility and quality for years of dependable service and listening enjoyment.

SERVICE

Do not attempt to service **PrecisionPower** products yourself. Performing exploratory surgery on your audio equipment yourself will void the warranty. Many parts of your **PrecisionPower** product are custom built to our specifications. Our factory parts are not made available to anyone else nor are they for sale. Our goal is to make sure that your **PrecisionPower** product will always sound as good as the day it was purchased. Contact your **Authorized PrecisionPower Dealer** about obtaining any warranty service through **PrecisionPower**. (See Warranty inside back cover)

CAUTION

The extended use of a high powered audio system may result in hearing loss or damage. While **PrecisionPower** systems are capable of "Concert Level" volumes with incredible accuracy, they are also designed for you to enjoy at more reasonable levels all of the sonic subtleties created by musicians. Please *try* to observe all local sound ordinances.



Three-Year Limited U.S.A Warranty

This warranty gives you specific legal rights, and you may also have other rights which vary from state to state. **PrecisionPower** warrants its products to be free from defects in materials and workmanship under normal use and service for a period of three (3) years from the date of original purchase when the unit is installed by an Authorized Dealer. Non-Authorized Dealer installed products carry a one (1) year parts and ninety (90) days labor limited warranty. The extent and conditions of Limited Warranty are as follows:

1. Authorized Dealer Installed Products: **PrecisionPower** will either repair or replace at no charge, to the original purchaser, any unit which **PrecisionPower** examination discloses to be defective and under warranty, provided the defect occurs within three (3) years from the date of original purchase when the unit is installed by an Authorized Dealer and the product is returned immediately to **PrecisionPower**. This warranty is not transferable.
2. Non-Authorized Dealer Installed Products: **PrecisionPower** will either repair or replace at no charge, to the original purchaser, any unit which **PrecisionPower** examination discloses to be defective and under warranty, provided the defect occurs within ninety (90) days from the date of purchase and the product is returned immediately to **PrecisionPower**. Warranty claims beyond ninety (90) days for Non-Authorized Dealer Installed Products will be for parts only and will extend for one (1) year from the date of purchase. This warranty is not transferable.
3. Internet and mail order products purchased from non authorized **PrecisionPower** dealers are not subject to factory warranty. **PrecisionPower** does not endorse or approve of internet and mail order sales, but will repair products at current non warranted part and labor rates.
4. The date of purchase and proof of Authorized Dealer Installation of a **PrecisionPower** product must be established by an original sales receipt which must accompany the article being re-turned for warranty work.
5. This warranty shall NOT apply to any **PrecisionPower** product found to have the original factory serial number removed or defaced. All products received (by **PrecisionPower**) for in warranty or out of warranty repair, with their original serial numbers removed or defaced, will NOT be repaired and will be returned to sender, freight collect. Refer to original packaging for the serial number of your component speakers.
6. The provisions of this warranty shall not apply to any **PrecisionPower** product used for a purpose for which it is not designed, which has been repaired or altered in any way, or which has been connected, installed, or adjusted other than in accordance with the instructions furnished in **PrecisionPower** owner's manual. Nor shall this warranty apply to any part which has been subject to misuse, neglect, or accident.
7. **PrecisionPower** does not authorize any other persons to assume any other liability in connection with its products. THIS WARRANTY IS THE ONLY EXPRESS WARRANTY MADE BY **PrecisionPower** APPLICABLE TO ITS PRODUCTS. ANY IMPLIED WARRANTY OR MERCHANTABILITY OR FITNESS FOR A PARTICULAR PURPOSE APPLICABLE TO **PrecisionPower** PRODUCTS IS LIMITED IN DURATION TO THE DURATION OF THIS LIMITED WARRANTY. **PrecisionPower** SHALL NOT BE LIABLE FOR THE INCIDENTAL, CONSEQUENTIAL, OR COMMERCIAL DAMAGES RESULTING FROM THE BREACH OF THIS WRITTEN WARRANTY. Some states or provinces do not allow the exclusion or limitation of incidental or consequential damages or limitations on how long an implied warranty lasts; so the above limitations or exclusions may not apply to you.
8. Your product will be serviced on an in-warranty basis within the warranty period for the correction of warranted defects. If improper operation of your **PrecisionPower** product should occur, contact your Authorized Dealer for assistance with the return and factory repair of your **PrecisionPower** product. If an Authorized Dealer is not available, return the unit including your name, telephone number, return address, a copy of your sales receipt, and a description of the problem to:

PrecisionPower
Service Department
9235 S. McKemy Street
Tempe, AZ 85284

TO RETURN **PrecisionPower** PRODUCTS OUTOF WARRANTY: Return the unit, postage prepaid, in the original protective carton. Please include a description of the problem and, if desired, a request for an estimate of repair costs. Unless a request for an estimate is included, the unit will be repaired as necessary. Please contact **PrecisionPower** Customer Service at 1-800-62-POWER for questions concerning out of warranty repair charges. Repaired unit will be returned with an itemized statement, C.O.D.

Free Manuals Download Website

<http://myh66.com>

<http://usermanuals.us>

<http://www.somanuals.com>

<http://www.4manuals.cc>

<http://www.manual-lib.com>

<http://www.404manual.com>

<http://www.luxmanual.com>

<http://aubethermostatmanual.com>

Golf course search by state

<http://golfingnear.com>

Email search by domain

<http://emailbydomain.com>

Auto manuals search

<http://auto.somanuals.com>

TV manuals search

<http://tv.somanuals.com>