

POWERCLASS™

PC2400 / PC2600 / PC21400 OWNER'S MANUAL



100%

CONTENTS

(click on a topic to view)

- ⚡ CONGRATULATIONS
- ⚡ FEATURES / SPECIFICATIONS
- ⚡ QBASS PLUS
- ⚡ INSTALLATION
- ⚡ WIRING
- ⚡ WIRING (continued)
- ⚡ POWER / GROUND
- ⚡ POWER, GROUND, and REMOTE
- ⚡ REAR ENDPLATE DIAGRAM
- ⚡ FRONT ENDPLATE DIAGRAM
- ⚡ SPEAKER WIRING
- ⚡ INPUTS
- ⚡ CROSSOVER/GAIN CONTROL
- ⚡ THERMAL MANAGEMENT
- ⚡ TROUBLE SHOOTING
- ⚡ SYSTEM DIAGRAM ONE
- ⚡ SYSTEM DIAGRAM TWO
- ⚡ SYSTEM DIAGRAM THREE
- ⚡ SYSTEM DIAGRAM FOUR
- ⚡ BLOCK DIAGRAM
- ⚡ ADDENDUM
- ⚡ WARRANTY

Congratulations and thank you.....

for choosing *PrecisionPower* audio equipment. At *PrecisionPower* we proudly design, engineer and manufacture audio products at our facility in Phoenix, Arizona. Our award winning engineering team utilizes innovative technology to consistently deliver *Absolutely State of the Art™* performance, sound quality, reliability, and value. This *PrecisionPower* product reflects our commitment to offer you unparalleled versatility and quality for years of dependable service and listening enjoyment.

Service



Do not attempt to service *PrecisionPower* products yourself. Performing exploratory surgery on your audio equipment yourself will void the warranty. Many parts of your *PrecisionPower* gear are custom built to our specifications. Our factory parts are not made available to anyone else nor are they for sale. Our goal is to make sure that your *PrecisionPower* product will always sound as good as the day it was purchased. Contact your authorized *PrecisionPower* dealer about obtaining any warranty service through *PrecisionPower*.(See Warranty inside back cover)

FOR YOUR RECORDS:

M o d e l _____

Serial Number _____

Purchase Date _____

Caution!



The extended use of a high powered audio system may result in hearing loss or damage. While *PrecisionPower* systems are capable of "Concert Level" volumes with incredible accuracy, they are also designed for you to enjoy at more reasonable levels all of the sonic subtleties created by musicians. Please observe all local sound ordinances.

FEATURES / SPECIFICATIONS

Adaptive MOSFET Switching Power Supply
 Fully Complementary Triple Darlington Output Stage
AM IV Protection Circuitry
QBASS PLUS™ Bass Boost
QBASS REMOTE™ Compatible
 Advanced Buss Technology
 Forced Air Thermal Management
 Two-Way 24dB/Octave Linkwitz-Riley 90Hz Crossover
 Crossover Line Outputs
 Balanced Differential Input Stage
 High Voltage Input Capability with Input Attenuation Switch
 Gold Plated RCA Input and Output Connectors
PowerLock Speaker and Power Wire Connectors
 Mixed Mono/Stereo Operation
 Three Year Warranty when installed by an Authorized **PrecisionPower** Dealer
 Completely Designed and Handcrafted in the USA

Specifications



Power Bandwidth	4.5 Hz - 100 kHz
Total Harmonic Distortion	0.02 %
Input Topology	Differential
Input Sensitivity	150mv - 12 volts RMS
Input Impedance	10 k Ohms
Load Impedance (stereo)	2 - 8 Ohms
Load Impedance (bridged)	4 - 8 Ohms
Supply Voltage	11 - 15 volts
Damping Factor	>500
Slew Rate	>50 V/μS
QBASS PLUS™	Up To +18dB Boost
Frequency Centers	30Hz, 36Hz, 44Hz and 60Hz
Idle Current:	PC2400 1.5 Amps PC2600 2 Amps PC21400 3 Amps
Crossover	Two Way, 24dB/Octave Linkwitz-Riley
Crossover Frequency	90Hz

Continuous Output Power



PC2400	100 WRMS x 2 @ 4Ω per channel 200 WRMS x 2 @ 2Ω per channel 400 WRMS x 1 @ 4Ω bridged
PC2600	150 WRMS x 2 @ 4Ω per channel 300 WRMS x 2 @ 2Ω per channel 600 WRMS x 1 @ 4Ω bridged
PC21400	350 WRMS x 2 @ 4Ω per channel 700 WRMS x 2 @ 2Ω per channel 1400 WRMS x 1 @ 4Ω bridged

Dimensions

Length - 15.75"
Height - 2.25"
Width - 8.9"
Length - 17.75"
Height - 2.25"
Width - 8.9"
Length - 25.25"
Height - 2.25"
Width - 8.9"

QBASS PLUS™



On **PC2400**, **PC2600** and **PC21400** amplifiers, we've taken bass control to a higher level with **QBASS PLUS™**. The two **QBASS** switches (labeled 1 and 2) on the front end of the amplifier allow you to select one of four frequency centers - 30Hz, 36Hz, 44Hz and 60Hz. The Q SELECT switch determines the width of boosted frequencies. A 'Q' of 2 (switch out) will give you a wide boost while a 'Q' of 4 will boost a narrow range of frequencies (See chart below). On the rear end panel you will find the **QBASS™** level control and the plug-in for an optional **QBASS REMOTE™** dash mounted level control. Adjust the level control clockwise for up to 18dB of boost at your selected frequency and Q.

QBASS™ Settings		
1	2	Freq.
IN	IN	30Hz
IN	OUT	36Hz
OUT	IN	44Hz
OUT	OUT	60Hz

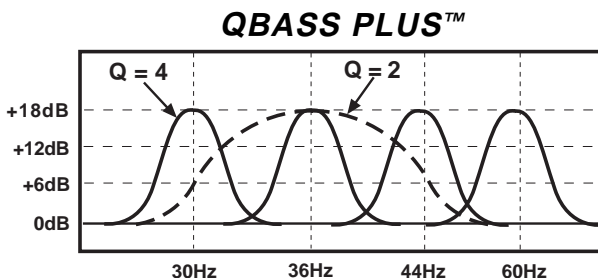

CAUTION: QBASS PLUS™ should only be used in systems with strong subwoofers. 18dB is a lot of bass boost and could damage full range speakers.

Optional **QBASS REMOTE™**

This boost control can be mounted in the dash and will supersede the boost control on the endplate.

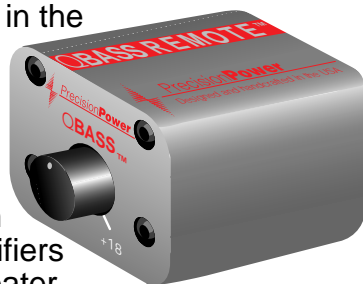

Optional **QPORT™** expansion module allows one boost control to operate multiple amplifiers. Each **QPORT™** has outputs for four amplifiers as well as another **QPORT™** for greater expansion. See your Authorized **PrecisionPower** Dealer for more information!

INSTALLATION

Tools/Parts needed for Installation (not supplied)



- Small flat blade screwdriver
- Phillips Screwdriver (#2 or medium sized)
- Wire cutters
- Wire strippers
- 4 - #6 round head screws, and 1 - #8 sheet metal screw (or nut, bolt, and star washer)
- 2 - Ring connectors (large enough to accommodate your method of grounding)
- In-line fuse or circuit breaker - see fuse chart below
- Power and ground wire - see Power Wire Calculator on page 3
- Speaker wire - 16 gauge or larger
- Grommets (sized to work with the power wire you plan to use in your installation)
- Tube of silicone sealant

Fuse requirements



Amplifier	Maximum Fuse Rating
<i>PC2400</i>	60 Amp
<i>PC2600</i>	80 Amp
<i>PC21400</i>	160 Amp

You will need to install an in-line fuse or circuit breaker in the power wire within 18" of the battery. This fuse or circuit breaker is to protect your vehicle from fire in case the power wire shorts to the vehicle body. If you are only using one amplifier, use the fuse rating indicated in this chart. If you are using more than one amplifier, add up the fuse ratings for all the amplifiers. This sum is the rating for your fuse or circuit breaker. You may also want to add a power distribution block near your amplifiers to keep the wiring tidy.

WIRING

The following is a basic formula to be used as a guide to determine current draw. A 50% amplifier efficiency rating is used as an average. Your new **POWERCLASS™** amplifier is more efficient, other amplifiers will probably be less. This formula is to be used as a guideline. Using wire of a larger gauge can only improve the current transfer of your system. Do not use smaller gauge wire.

Total RMS output x 2 = Total Input Wattage

$$\frac{\text{Total Input Wattage}}{\text{Supply Voltage}} = \text{Current Draw (in Amps)}$$

Example: A **POWERCLASS™** 2600 amplifier has two channels at 150 watts per channel RMS rating into 4 Ohms (150 x 2 = 300). You would use the formula in the following way:

$$300W \times 2 = 600W$$

$$\frac{600W}{12V} = 50A \text{ Total current draw.}$$

If the same amplifier is driven into a 2 Ohm stereo or 4 Ohm mono load, double it's 4 Ohm RMS rating. All **POWERCLASS™** amplifiers will effectively double their power at this load.

$$300W \times 2 \times 2 = 1200W$$

$$\frac{1200W}{12V} = 100A \text{ Total current draw.}$$

If you are using more than one amplifier, add up the total current draw for all of them and choose the appropriate gauge based on the grand total.

Power Wire Calculator



Recommended MINIMUM Gauge

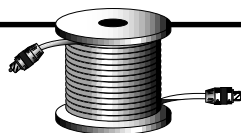

Total Current Draw (in Amps)	Length Of Wire To Be Run							
	Up to 4ft.	4 to 7ft.	7 to 10ft.	10 to 13ft.	13 to 16ft.	16 to 19ft.	19 to 22ft.	22 to 28ft.
0-20	14	12	12	10	10	8	8	8
20-35	12	10	8	8	6	6	6	4
35-50	10	8	8	6	6	4	4	4
50-65	8	8	6	4	4	4	4	2
65-85	6	6	4	4	2	2	2	0
85-105	6	6	4	2	2	2	2	0
105-125	4	4	4	2	2	0	0	0
125-150	2	2	2	2	0	0	0	00

NOTE: The ground wire should be the same gauge as the power wire.

WIRING

Before beginning, disconnect the negative (-) terminal of the battery prior to working on the positive (+) terminal to prevent a short to ground. This is important, unless you want to spend the rest of your life with a nickname like "Sparky," or "Smokey." Reconnect the negative terminal only after all connections have been made.

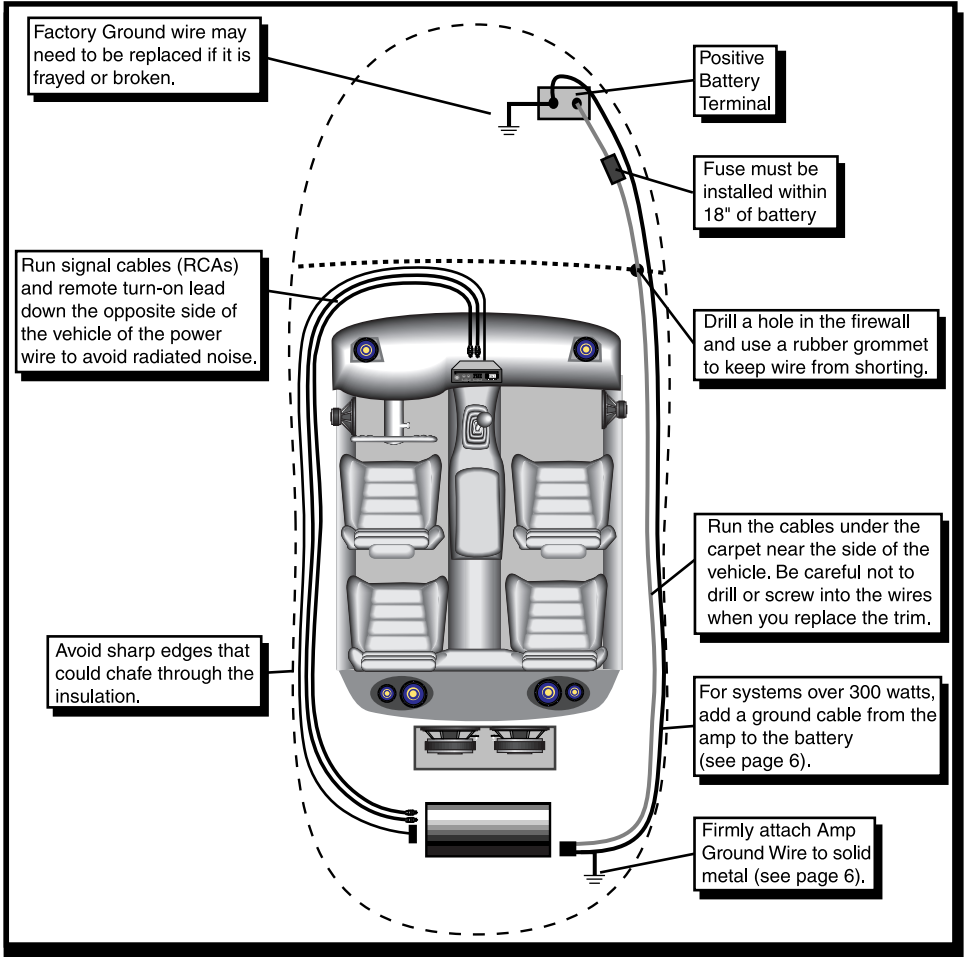

Warning!

Fuse must be installed within 18" of battery

Grounding



Locate an area near the amplifier(s) that is metal and clean an area about the size of a quarter to bare metal. Inspect the area around and underneath to be sure you won't drill into wires, brake or fuel lines, etc. Drill a pilot hole in the middle of this area. Terminate the ground wire with a ring connector and attach it to the bare metal using a #8 sheet metal screw and washer or preferably, a bolt, nut and a star washer (not supplied). We suggest crimping and soldering this connection. After the connection is complete, coat the area (on both sides) with silicone or some similar material to prevent rust from developing on the bare metal.

If your grand total current draw is over 50 amps (or total output power is over 300 watts), you should run a ground wire beside your power wire from the battery to the amplifier(s) in addition to your regular ground wire. Keep the ground and power wires as close together as possible, and use the same gauge wire for both. This will ensure that you have a good ground path, and may eliminate such potential problems as engine noise and overheated amplifiers.

Charging System Considerations



If your grand total current draw is over 100 amps (or total output power is over 600 watts), you are probably exceeding the capability of your charging system. Dimming lights and fluctuating voltage are solid indicators that you need to upgrade your alternator, battery (or go to multiple batteries), or both. Keep in mind that your amplifiers simply convert electrical energy to acoustical energy, and any electrical deficiency will compromise the performance of your sound system. For more information about charging system upgrades, see your local authorized *PrecisionPower* Dealer or call the *PrecisionPower* technical support office at 1-800-62**POWER**.

POWER / GROUND and REMOTE

Once you have run both the power and ground wires, it's time to connect the cables to the amplifier. Cut off excess wire and, using wire strippers, strip the ends of the power and ground cables approximately 1/4 inch. Locate the **PowerLock** power and ground connector (supplied). With a small flat bladed screw driver, loosen the screws before attempting to insert the cables. Insert the wires into the appropriate hole, and tighten the screws. Once the wires are secure, the **PowerLock** may be plugged into the amplifier. The Power/Ground **PowerLock** will accommodate 4 gauge wire for the **PC2400**, **PC2600** and **PC21400**.

Power/Ground **PowerLock**

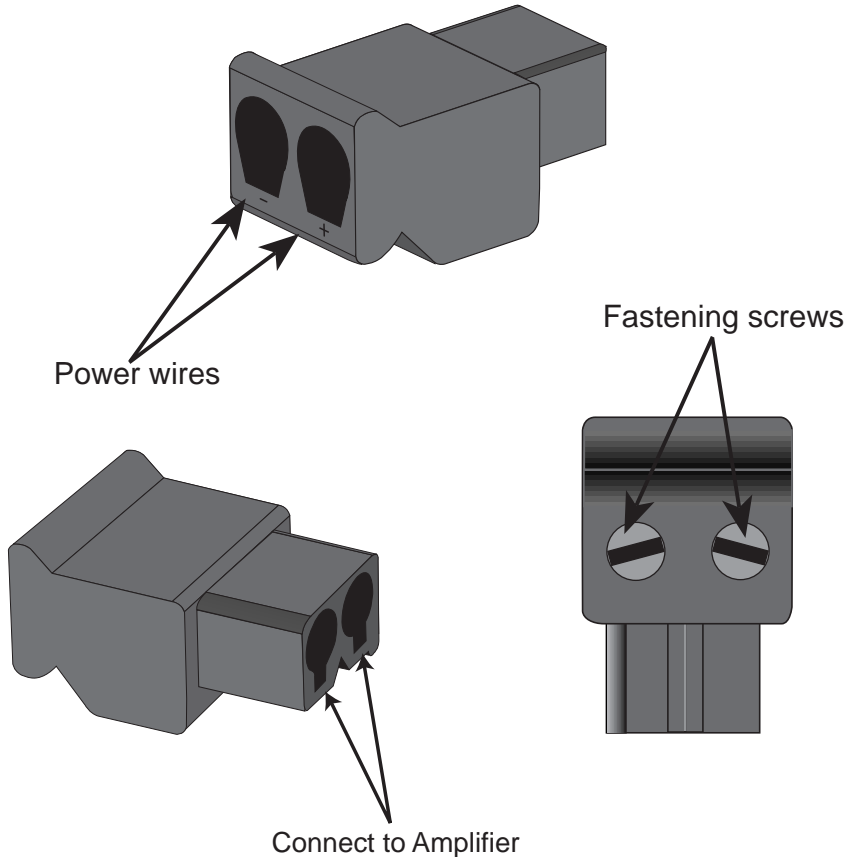

ENDPLATE DIAGRAM

2400 / 2600 / 21400

1. QBASS REMOTE™ plug in

Plug in the data cable from the optional **QBASS REMOTE™** dash mount level control here. (This will bypass the amplifier's on board **QBASS** control)

2. COOLING VENTS (see page 13).

3. POWER / GROUND POWERLOCK

After you have securely connected your power and ground wires, plug in the Power / Ground **POWERLOCK** connector here (see page 7).

4. POWER indicator

A green light indicates that the amplifier is on.

5. QBASS™ Level

Turn this control clockwise to boost the **QBASS PLUS™** circuit by up to 18dB.

6. FORCED AIR INTAKE VENTS (see page 13).

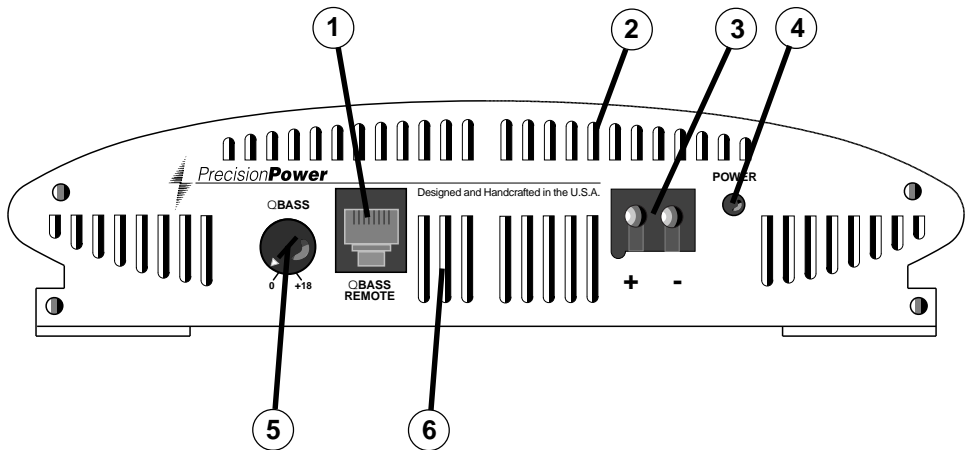

ENDPLATE DIAGRAM

2400 / 2600 / 21400

1. FRONT INPUTS

Plug in the RCA leads from your head unit here (see page 11).

2. GAIN

Use this control to match the output level of the head unit to the amplifier (see page 12).

3. HP/LP switch

This switch is used to select whether the amplifier will provide a high pass (switch in) or low pass (switch out) signal to the speakers. (see page 12).

4. QBASS 1

Use this switch with the **QBASS 2** to program the **QBASS PLUS™** circuit. (see page 2).

5. QBASS 2

Use this switch with the **QBASS 1** to program the **QBASS PLUS™** circuit. (see page 2).

6. FORCED AIR EXHAUST VENTS (see page 13).

7. SPEAKER/REMOTE CONNECTOR

After connecting remote and speaker wires, plug in the **PowerLock** connector here (see page 10).

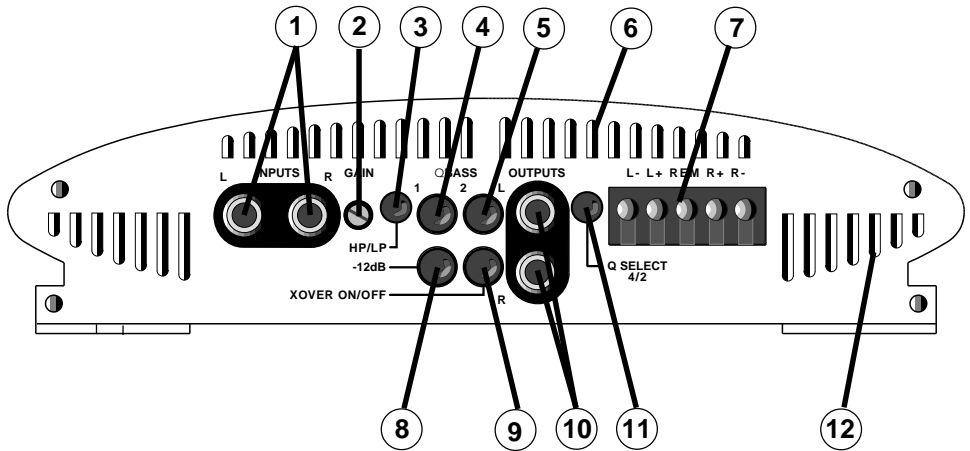

8. -12dB

For use with high level inputs (4V up to 12V). Push this switch in to attenuate the input by 12dB (see page 11).

9. XOVER ON/OFF switch

Push this switch in to activate the crossover, or out for full range speaker outputs (see page 12).

10. OUTPUTS

Left and Right RCA outputs provide high pass or low pass signal to another amplifier (see page 12). NOTE - RCA outputs are always high pass or low pass.

11. Q SELECT 4/2

Push this button in for a Q setting of 4 and out for a setting of 2 (see page 2).

12. FORCED AIR INTAKE VENTS (see page 13).

SPEAKER WIRING

Using 16 gauge or larger, run the speaker wires from the amplifier location through the vehicle to the speakers. Observe the same precautions for routing these wires that you followed for running the power and remote turn-on wires. Cut off excess and, using wire strippers, strip 1/4 inch of insulation. Locate the speaker/remote turn-on **PowerLock** connector. Loosen the four outer screws on the underside of the connector. Insert the speaker leads into the end. Check to be sure you've maintained proper polarity before securing each wire, and plug the **PowerLock** into the amplifier.

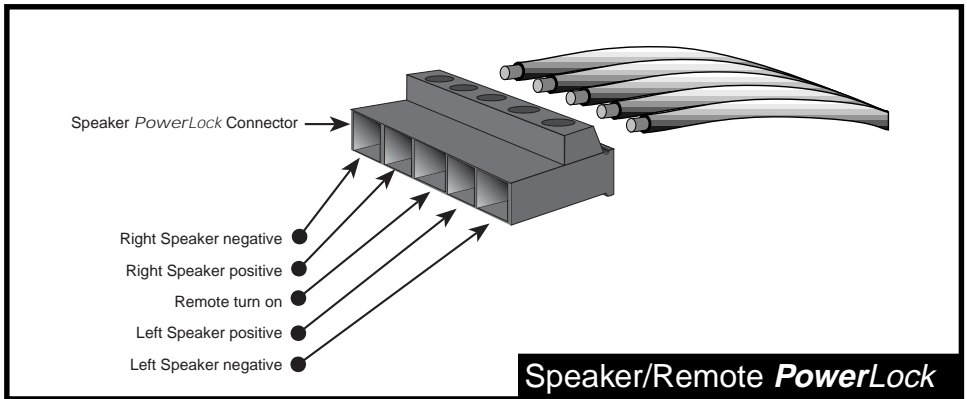

Bridging



All two-channel **POWERCLASS™** amplifiers are capable of being bridged into a 4 ohm mono output without switches or bridging modules. This feature permits the creation of a mono channel for a subwoofer or center channel.

Deriving the mono channel is accomplished by using the left channel positive wire as the positive speaker wire and the right channel negative wire as the negative speaker wire.

NOTE: It is important that a minimum 4 ohm impedance is observed. If the impedance drops below 4 ohms while the amplifier is wired in the bridged configuration, the amplifier's protection circuitry (AM IV) may engage.

INPUTS

There are two sets of RCA jacks on the front end of your amplifier. The RCA cables from your head unit go in the set labeled INPUTS. If your head unit doesn't have RCA outputs don't worry. Simply add a set of RCA plugs (available at your dealer) to your front or rear set of speaker leads (see drawing below), plug them into the input jacks, and push in the -12dB input attenuation switch.

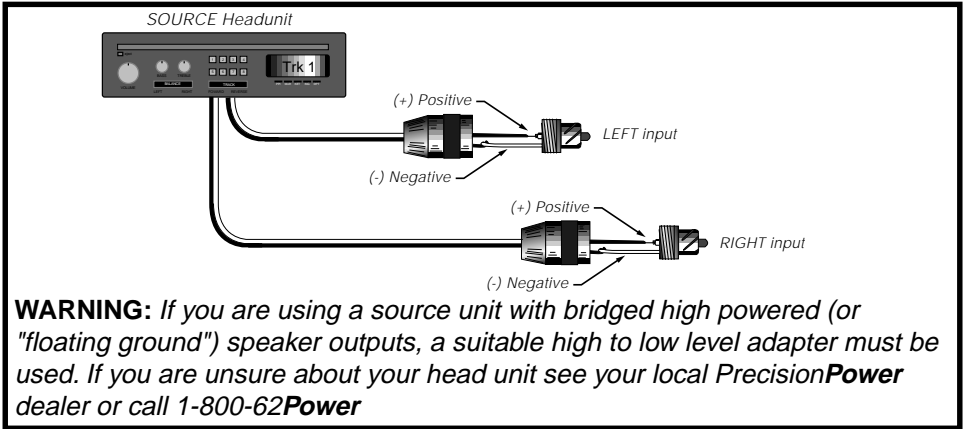

Balanced Differential Inputs



This circuitry reduces noise radiated into your signal cables by up to 40dB. This is equivalent to a noise reduction of approximately one hundred times what the noise level would be without this circuitry. It provides all the benefits of a true 'balanced' line without the need of any special cables (see diagram below). This type of input works with any conventional RCA cable.

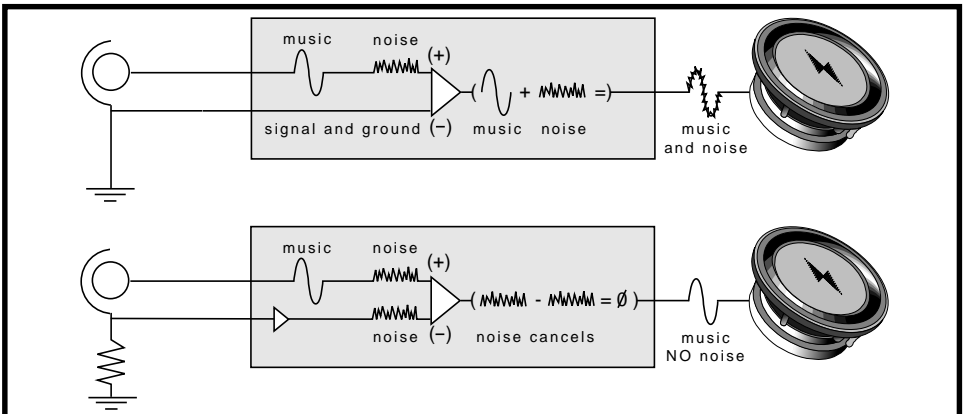

Crossover



Your new **POWERCLASS™** amplifier has a 90Hz fourth-order Linkwitz-Riley type, 24dB per octave phase correlated crossover built in to provide system flexibility without the added expense and installation of an outboard crossover. The speaker outputs of your amplifier are high pass or low pass according to the HP/LP switch on the front endplate.

You would choose low pass (switch out) to use this amp for subwoofers, or choose high pass (switch in) to use this amp for full range speakers. The RCA outputs are controlled by the same HP/LP switch, but are always the inverse of the speaker output crossover. If the HP/LP switch is out (LP) the RCA outputs will be high pass, and if the HP/LP switch is in (HP) the RCA outputs will be low pass. In addition, the speaker outputs can be all pass (no crossover) by setting the XOVER ON/OFF switch to the off (out) position.

NOTE: The RCA outputs are always crossed over. The System Diagrams beginning on page 14 show several ways to use the internal crossover in your system.

Adjusting The Amplifier Input Gain



1. Adjust all amplifier input gain controls to just above minimum sensitivity (fully counterclockwise).
2. Using the cleanest source (CD), with music playing turn up the head unit until you can hear distortion. Now turn it down a bit until you cannot hear the distortion.
3. Increase the Amplifier gain (clockwise) until the onset of audible distortion. Then decrease the gain to the point just before the distortion starts. This setting minimizes background noise and prevents overload.
4. Repeat step 3 for any remaining amplifiers in the system.

THERMAL MANAGEMENT

Heatsink Cooling



The unique heatsink on your **POWERCLASS™** amplifier has been designed with fins on the inside of the aluminum mass. This allows for the transfer of heat from the circuitry to the heatsink fins and out through the vents in the endplates. Be sure you have ample space around the amplifier for cooling, at least 2" on all sides.

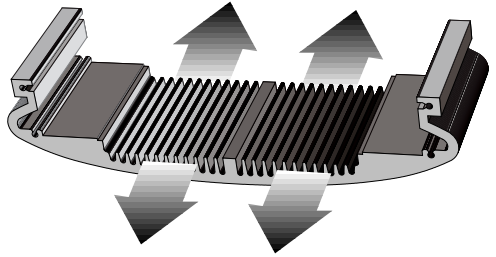

Forced Air Thermal Management



To manage the additional heat associated with higher output capability, a thermally controlled fan has been designed into the **PC2600** and **PC21400**. When the heatsink temperature reaches a pre-determined value, the fan is activated and cool air is drawn in through the lower intake vents on the endplate. This cool air flows below the circuit board, through the fan and across the internal fins, cooling the heatsink. The warm air is then forced out through the upper endplate exhaust vents.

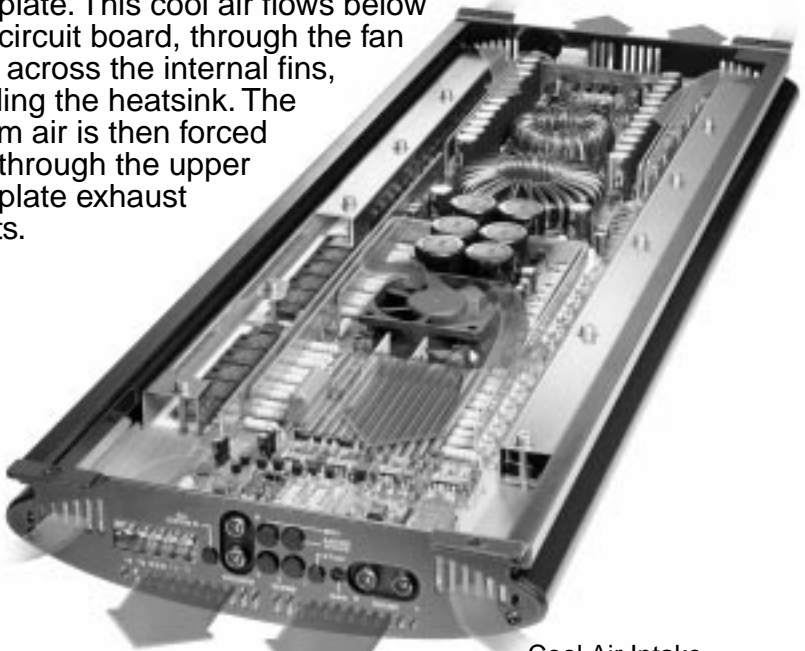

Warm Air Exhaust

Cool Air Intake

TROUBLE SHOOTING

NO SOUND

Is the LED lit?

YES

NO

Check Power and Remote turn-on wire for voltage. Make sure Ground wire is secure.

STILL NO SOUND - See your Authorized *PrecisionPower* Dealer or call 1-800-62**POWER**.

SOUND IN ONE CHANNEL ONLY

Reverse left and right speakers by unplugging the speaker connector, turning it over and plugging it back in.

SOUND IS NOW IN

OPPOSITE CHANNEL

Reverse RCA inputs

SAME CHANNEL

Problem is in the speaker or speaker wire of the silent channel.

SOUND IS NOW IN

OPPOSITE CHANNEL

Reverse RCAs at head unit

SAME CHANNEL

Problem is in the Amplifier. See your local Authorized *PrecisionPower* Dealer or call 1-800-62**POWER**.

SOUND IS NOW IN

OPPOSITE CHANNEL

Problem is in the head unit

SAME CHANNEL

Problem is in the RCA cables

AMPLIFIER TURNS DOWN

Both excessive temperature and low impedance (or short circuit) conditions will activate the amplifier's AM IV protection circuitry, which turns down the amplifier's output. When the amplifier cools down, or the impedance is corrected, the AM IV will restore full power.

If your amp is turning down check your speakers and wiring for low impedance and short circuits. Also, ensure that there is nothing blocking the normal convective airflow of the amplifier. No obstruction should be within 2" of the amplifier on all sides.

NOTE: Low battery voltage will cause the amplifier to run warmer.

SYSTEM DIAGRAM

ONE

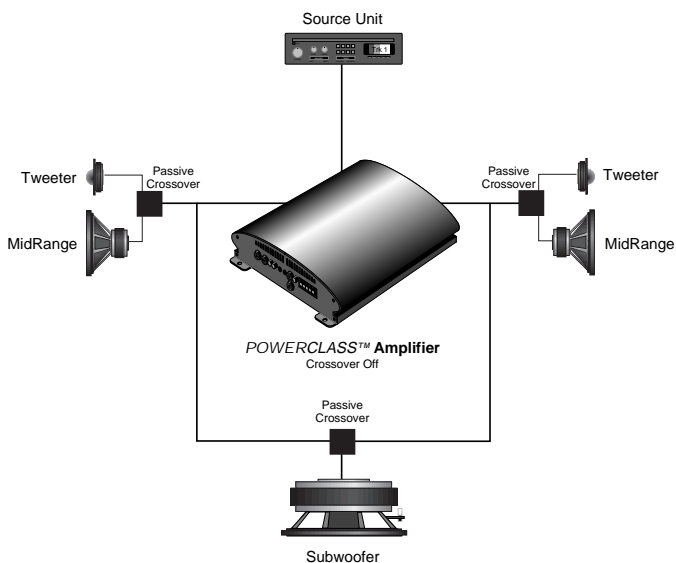

Mixed Mono Output

The ability to run stereo speakers while simultaneously running a mono output from the same amplifier is accomplished by running the stereo speakers normally and tapping into the appropriate wires for the "mixed mono" channel (left channel positive for the positive speaker wire and right channel negative for the negative speaker wire). Speaker impedance should be no lower than 2 Ohms on the stereo channels and 4 ohms on the mono channel.

NOTE: Passive crossovers must be used for "mixed mono" operation. Choose a low pass crossover around 100Hz for your subwoofer, then choose a high pass crossover for your stereo channels. The high pass crossover must be at the same or slightly higher frequency than the low pass crossover to maintain the correct impedance. See your *PrecisionPower* dealer or call **1-800-62POWER** for more information about passive crossovers.

SYSTEM DIAGRAM TWO

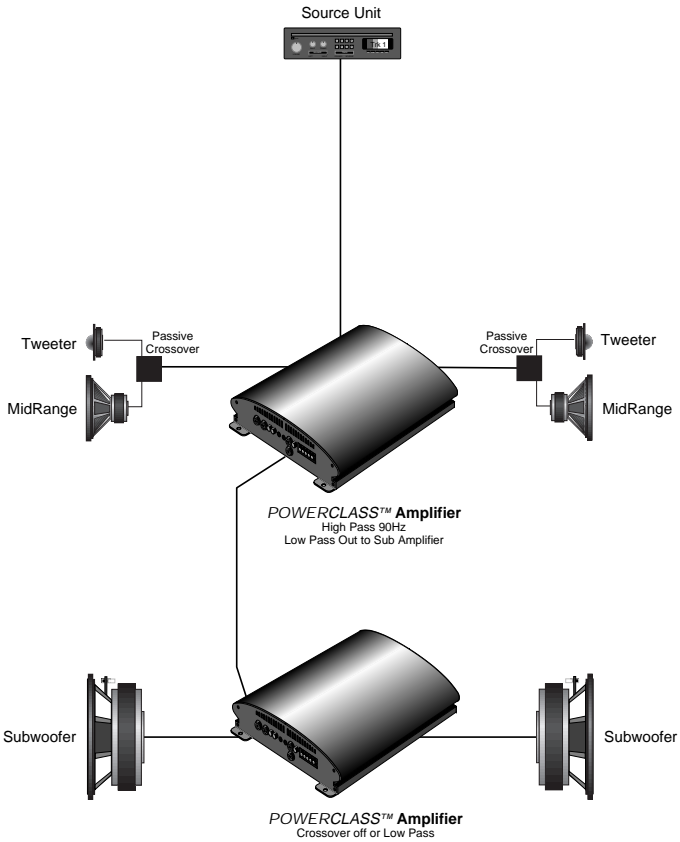

SYSTEM DIAGRAM THREE

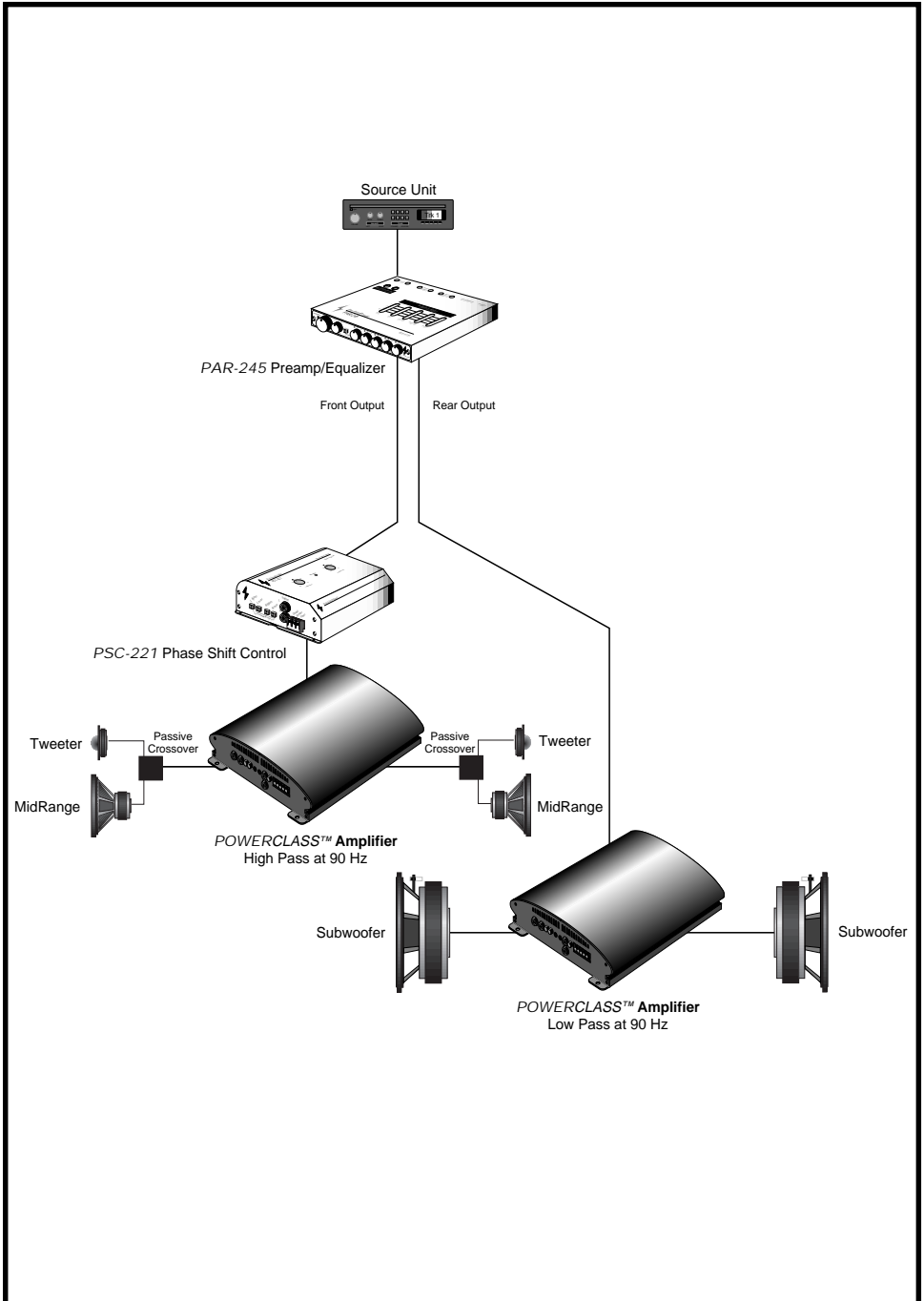

SYSTEM DIAGRAM

FOUR

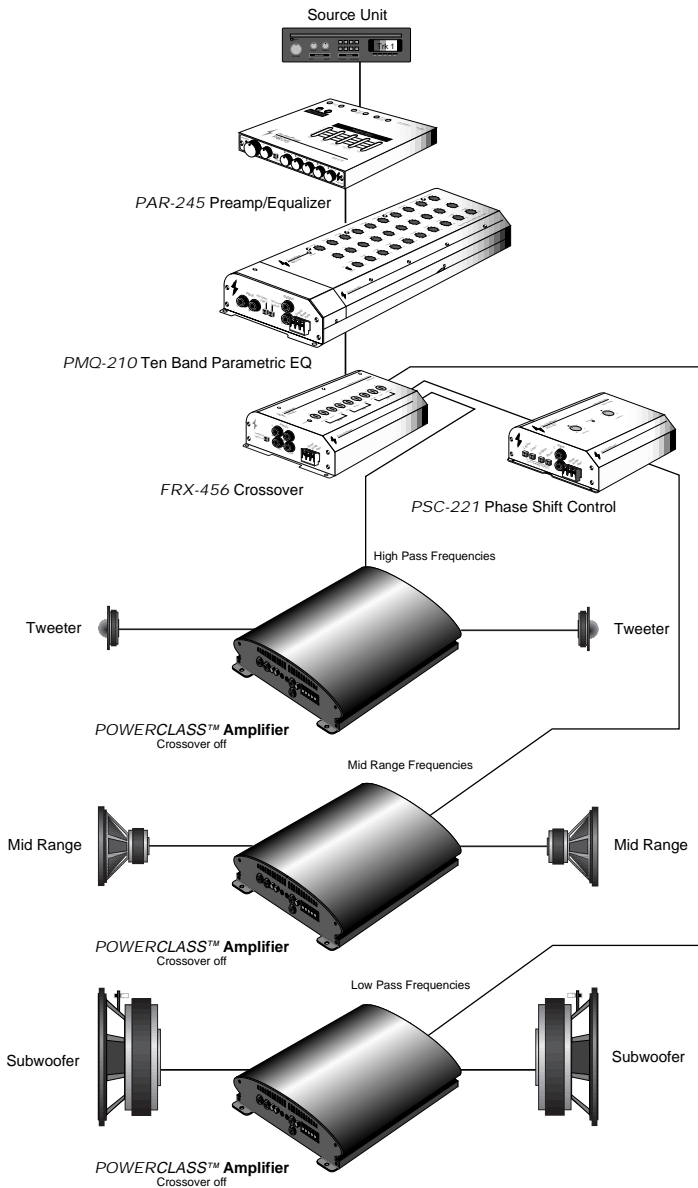

BLOCK DIAGRAM

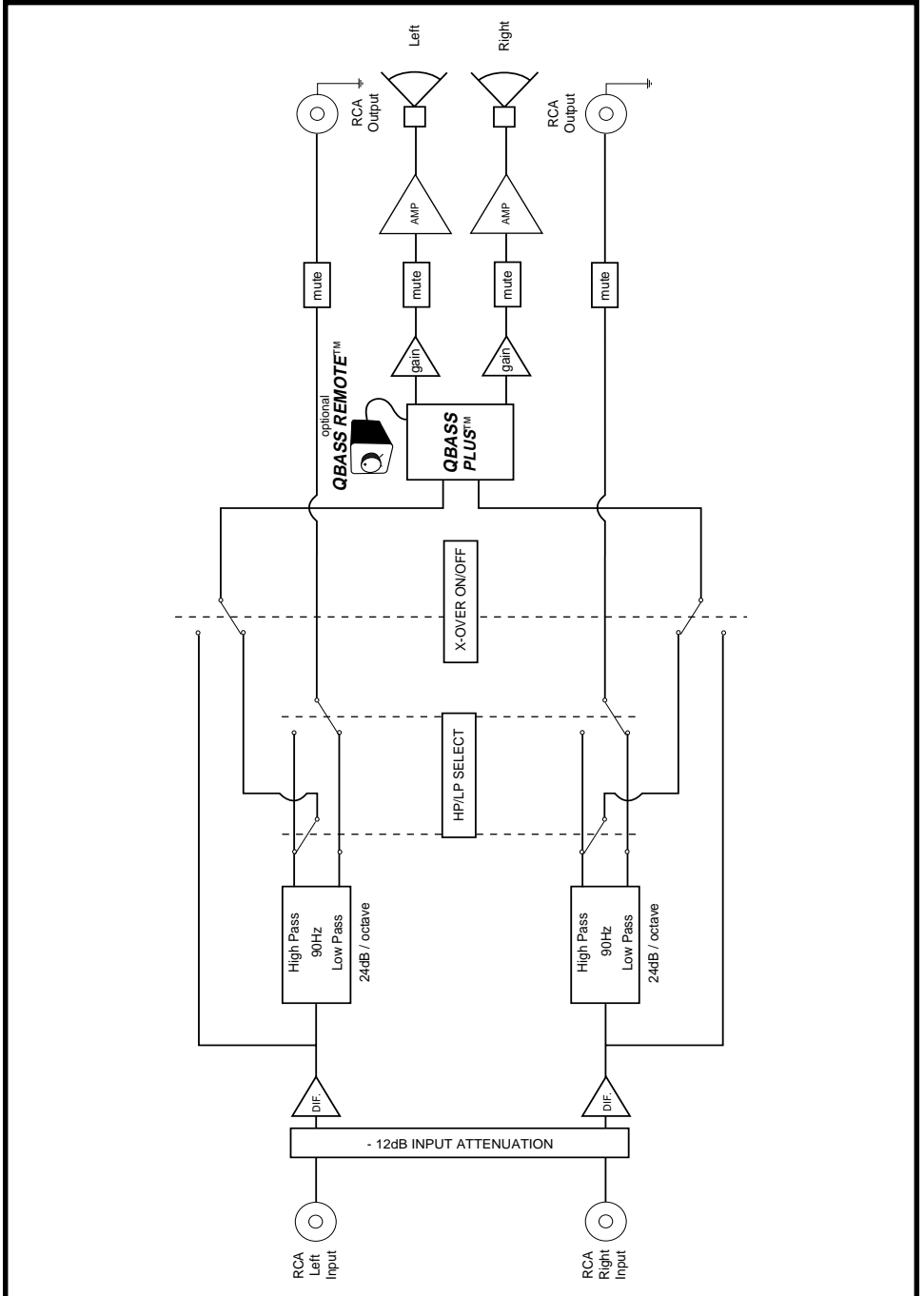

POWERCLASS ADDENDUM

Your new **POWERCLASS™** amplifier may have been updated to include a variable detented crossover in place of the Q 4/2 function switch. The crossover is adjustable from 20 Hz to 5 kHz. Please refer to the endplate diagram and detent chart provided for frequency adjustments. The **XOVER FREQ** control has detents, or “clicks” as you rotate it. Each “click” counted from the full counterclockwise position corresponds to a specific frequency. This will add more accurate tuning to your system. Also, refer to your owner’s manual for installation instructions. As always, **PrecisionPower** will continue to improve the products and services we have to offer you. Thank you for choosing **PrecisionPower!**

DETENT	XOVER FREQ
1	20 Hz
2	21 Hz
3	21 Hz
4	21.5 Hz
5	22 Hz
6	23 Hz
7	24.5 Hz
8	26 Hz
9	27.5 Hz
10	30 Hz
11	32 Hz
12	35 Hz
13	39 Hz
14	43 Hz
15	49 Hz
16	56 Hz
17	64 Hz
18	73 Hz
19	80 Hz
20	88 Hz
21	100 Hz
22	114 Hz
23	134 Hz
24	160 Hz
25	196 Hz
26	260 Hz
27	320 Hz
28	368 Hz
29	432 Hz
30	496 Hz
31	608 Hz
32	752 Hz
33	864 Hz
34	1008 Hz
35	1200 Hz
36	1488 Hz
37	1952 Hz
38	2816 Hz
39	4512 Hz
40	4944 Hz
41	5000 Hz

New variable crossover

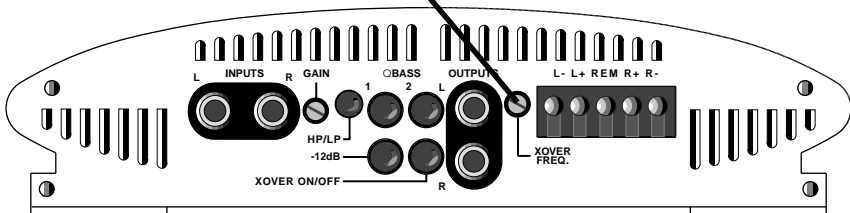

WARRANTY

Three-Year Limited U.S.A. Warranty

This warranty gives you specific legal rights, and you may also have other rights which vary from state to state. **PrecisionPower** warrants its products to be free from defects in materials and workmanship under normal use and service for a period of three (3) years from the date of original purchase when the unit is installed by an Authorized Dealer. Non-Authorized Dealer installed products carry a one (1) year parts and ninety (90) days labor limited warranty. The extent and conditions of Limited Warranty are as follows:

1. Authorized Dealer Installed Products: **PrecisionPower** will either repair or replace at no charge, to the original purchaser, any unit which **PrecisionPower's** examination discloses to be defective and under warranty, provided the defect occurs within three (3) years from the date of original purchase when the unit is installed by an Authorized Dealer and the product is returned immediately to **PrecisionPower**. This warranty is not transferable.

2. Non-Authorized Dealer Installed Products: **PrecisionPower** will either repair or replace at no charge, to the original purchaser, any unit which **PrecisionPower's** examination discloses to be defective and under warranty, provided the defect occurs within ninety (90) days from the date of purchase and the product is returned immediately to **PrecisionPower**. Warranty claims beyond ninety (90) days for Non-Authorized Dealer Installed Products will be for parts only and will extend for one (1) year from the date of purchase. This warranty is not transferable.

3. The date of purchase and proof of Authorized Dealer Installation of a PrecisionPower product must be established by an original sales receipt which must accompany the article being returned for warranty work.

4. This warranty shall NOT apply to any **PrecisionPower** product found to have the original factory serial number removed or defaced. All products received (by **PrecisionPower**) for in warranty or out of warranty repair, with their original serial numbers removed or defaced, will NOT be repaired and will be returned to sender, freight collect. Refer to original packaging for the serial number of your component speakers.

5. The provisions of this warranty shall not apply to any **PrecisionPower** product used for a purpose for which it is not designed, which has been repaired or altered in any way, or which has been connected, installed, or adjusted other than in accordance with the instructions furnished in **PrecisionPower's** owner's manual. Nor shall this warranty apply to any part which has been subject to misuse, neglect, or accident.

6. PrecisionPower does not authorize any other persons to assume any other liability in connection with its products. THIS WARRANTY IS THE ONLY EXPRESS WARRANTY MADE BY PRECISIONPOWER APPLICABLE TO ITS PRODUCTS. ANY IMPLIED WARRANTY OR MERCHANTABILITY OR FITNESS FOR A PARTICULAR PURPOSE APPLICABLE TO PRECISIONPOWER PRODUCTS IS LIMITED IN DURATION TO THE DURATION OF THIS LIMITED WARRANTY. PRECISIONPOWER SHALL NOT BE LIABLE FOR THE INCIDENTAL, CONSEQUENTIAL, OR COMMERCIAL DAMAGES RESULTING FROM THE BREACH OF THIS WRITTEN WARRANTY. Some states or provinces do not allow the exclusion or limitation of incidental or consequential damages or limitations on how long an implied warranty lasts; so the above limitations or exclusions may not apply to you.

7. Your product will be serviced on an in-warranty basis within the warranty period for the correction of warranted defects. If improper operation of your **PrecisionPower** product should occur, contact your Authorized Dealer for assistance with the return and factory repair of your **PrecisionPower** product. If an Authorized Dealer is not available, return the unit including your name, telephone number, return address, a copy of your sales receipt, and a description of the problem to:

PrecisionPower, Inc.
Service Department
4829 S. 38th Street
Phoenix, AZ 85040-2964

TO RETURN PRECISIONPOWER PRODUCTS OUT OF WARRANTY: Return the unit, postage prepaid, in the original protective carton. Please include a description of the problem and, if desired, a request for an estimate of repair costs. Unless a request for an estimate is included, the unit will be repaired as necessary. Please contact **PrecisionPower** Customer Service at 1-800-62-POWER for questions concerning out of warranty repair charges. Repaired unit will be returned with an itemized statement, C.O.D.

Free Manuals Download Website

<http://myh66.com>

<http://usermanuals.us>

<http://www.somanuals.com>

<http://www.4manuals.cc>

<http://www.manual-lib.com>

<http://www.404manual.com>

<http://www.luxmanual.com>

<http://aubethermostatmanual.com>

Golf course search by state

<http://golfingnear.com>

Email search by domain

<http://emailbydomain.com>

Auto manuals search

<http://auto.somanuals.com>

TV manuals search

<http://tv.somanuals.com>