

 **9.45i**

Owner's Manual

Low Impact Treadmill
featuring the
Cardiologic System

PRECOR[®] USA

IMPORTANT SAFETY INSTRUCTIONS

When using an electrical appliance, basic precautions should always be followed, including the following:

- Read all instructions before using the M9.45i Low Impact Treadmill. These instructions were written to ensure your safety and to protect the treadmill.

Before beginning any fitness program, you should have a complete physical examination by your physician.

Il est conseillé de subir un examen médical complet avant d'entreprendre tout programme d'exercice. Si vous avez des étourdissements ou des faiblesses, arrêtez les exercices immédiatement.

DANGER — To reduce the risk of electrical shock always unplug the M9.45i Low Impact Treadmill from the electrical outlet immediately after using and before cleaning.

WARNING — To reduce the risk of burns, fire, electric shock, or injury to persons, take the following precautions:

- When it is plugged in do not leave the M9.45i unattended. Unplug the unit from the power source when it is not in use, and before putting on or taking off parts.
- Do not allow children, invalids, or disabled persons on or near the M9.45i without adult supervision.
- Use the M9.45i only for its intended use as described in this manual. Do not use accessory attachments that are not recommended by the manufacturer—such attachments might cause injuries.
- Check the M9.45i before each use. Completely assemble the treadmill before using it.
- Never operate the treadmill if it has a damaged cord or plug, if it is not working properly, if it has been dropped or damaged, or dropped in water. Return the treadmill to a Precor authorized service center for examination and repair.
- Keep the power cord away from heated surfaces.
- Never block the air openings on the hood while operating the M9.45i. Keep the air openings clean and free of lint, hair, or anything that might impede the free flow of air.
- Never drop or insert objects into any opening. Keep hands away from moving parts.
- Do not operate where aerosol (spray) products are being used or where oxygen is being administered.
- Do not use outdoors.
- To disconnect, turn all controls to the OFF (0) position, then remove the power plug from the outlet.

WARNING— Connect the M9.45i to a properly grounded outlet only. See *Grounding Instructions*.

SAVE THESE INSTRUCTIONS

CAUTION: To effectively use the magnetic safety key, make sure that the key's cord falls under the handrail crossbar before you clip the cord to your workout clothes. See Diagram 10 on page 9.

Personal Safety

- Always attach the safety clip to your clothing at waist level prior to beginning your workout. The safety clip is connected by a cord to the magnetic safety key in the electronic console. If you encounter difficulties, you can stop the running belt by pulling on the cord to disengage the magnetic safety key from inside the console. To resume operation, the magnetic safety key must be replaced.
- When the treadmill is not being used, remove the magnetic safety key and store it in a safe place to prevent unauthorized use.
- Assemble and operate the M9.45i on a solid, level surface. Locate the treadmill at least 4 feet from walls or furniture. Keep the area behind the treadmill clear.
- Wear proper exercise clothing and shoes for your workout—no loose clothing. Do not wear shoes with heels or leather soles. Check the soles of your shoes and remove any dirt and embedded stones. Tie long hair back.
- Keep all loose clothing and towels away from the running surface. The running belt will not stop immediately if an object becomes caught in the belt or rollers.
- Use care when getting on or off the treadmill. Use the handrails whenever possible. Step onto the running belt when the speed is at or below 1 mile per hour (1.6 kilometers per hour). Never step off the treadmill while the running belt is moving.
- Before the running belt begins moving (prior to your workout), and after it stops (at the end of your workout), straddle the belt by placing your feet firmly on the right and left side platforms.
- Never turn ON the treadmill when someone is standing on the machine.
- Keep your body and head facing forward. Never attempt to turn around on the treadmill when the running belt is moving.
- Do not rock the unit. Do not stand or climb on the handrails, electronic console, or hood.
- Do not attempt to service the M9.45i treadmill yourself other than the assembly and maintenance instructions found in this manual. The M9.45i treadmill is for household use only. See *Obtaining Service* in the maintenance section of this manual.
- Do not overexert yourself or work to exhaustion.
- Stop your workout immediately if you feel any pain or abnormal symptoms, and consult your physician

Precor Heart Rate Option—Safety Guidelines

The Precor Heart Rate Option was created and designed exclusively for Precor products. The equipment is extremely sensitive—you should use the heart rate option with this in mind and take time to read the following guidelines:

- Handle the Precor Heart Rate Option with care. Do not drop the equipment. It might damage the transmitter and you could void the manufacturer's limited warranty.
- Do not place the chest strap near strong electromagnetic radiation sources. Television sets, electric motors, radios, and high voltage power lines can interfere with the heart rate signal that is being transmitted to the receiver and might affect the heart rate readings that appear on the electronic console.
- Use only one chest strap at a time inside the range of the receiver. If the receiver tries to process several signals simultaneously, an incorrect heart rate reading could result. Be sure to keep any other transmitters at least 5 feet (1.5 meters) away from the receiver on your M9.45i treadmill.

- Keep the equipment dry. Although the chest strap should not be immersed in water, wetting the electrodes and your chest will improve the initial performance. Note that perspiration on the chest strap during workouts is normal and actually enhances the signal being sent from the chest strap's transmitter.
- To conduct the electrical impulses from your heart, the chest strap's electrodes require a certain percentage of salts and minerals in the water used to wet them. The electrodes continue to transmit your heart rate reading as long as they are in contact with your skin and your skin is providing enough moisture through your perspiration to keep the electrodes wet. However, if the concentration of salts in your perspiration is not high enough to conduct electrical impulses and send them to the receiver, your heart rate reading will appear erratic or not appear at all. Some people cannot use the heart rate feature because they do not have the proper body chemistry.
- Do not use the chest strap if you are taking any medication or have a cardiac pacemaker. Inaccurate heart rate readings can occur due to medication or electrical impulses from the cardiac pacemaker.
- Stretching or bending the electrode strips on the chest strap may cause the strips to lose their conductivity. Handle the chest strap with care.
- After extensive use, the chest strap (transmitter) may wear out, causing inaccurate heart rate readings. With every use, check the strap for excessive wear and replace it if necessary. See *Obtaining Service* in on page 37.

Precor treadmills are designed for the enjoyment of the serious runner as well as the dedicated walker. By following the above precautions and using good common sense, you will have many safe and pleasurable hours of healthful exercise with your Precor treadmill.

Information Regarding Use in the U.S.A. and Canada

FCC Communications Commission, part 15

The M9.45i treadmill has been tested and found to comply with the limits for a Class B digital device, pursuant to part 15 of the FCC Rules. These limits are designed to provide reasonable protection against harmful interference in a residential installation. The M9.45i treadmill generates, uses, and can radiate radio frequency energy and, if not installed and used in accordance with the owner's manual instructions, may cause harmful interference to radio communications. However, there is no guarantee that interference will not occur in a particular installation.

If the M9.45i treadmill does cause harmful interference to radio or television reception, which can be determined by turning the M9.45i treadmill OFF and ON, you are encouraged to try to correct the interference using one or more of the following measures:

- Reorient or relocate the receiving antenna for your TV, radio, VCR, etc.
- Increase separation between the M9.45i treadmill and the receiver (TV, radio, etc.).
- Connect the M9.45i treadmill into a different power outlet—on a dedicated circuit different from the one used by the receiver (TV, radio, etc.). No other appliance should be plugged into the same power outlet that the treadmill is connected to.
- Consult your dealer or an experienced radio/TV technician for help.

WARNING— Per FCC rules, changes or modifications, not expressly approved by Precor, could void the user's authority to operate the equipment.

Canadian Department of Communications

"This digital apparatus does not exceed the Class B limits for radio noise emissions from digital apparatus set out in the Radio Interference Regulations of the Canadian Department of Communications."

"Le présent appareil numérique n'émet pas de bruits radioélectriques dépassant les limites applicables aux appareils numériques de la class B prescrites dans le Règlement sur le brouillage radioélectrique édicté par le ministère des Communications du Canada."

Grounding Instructions

The M9.45i Low Impact Treadmill must be grounded. If it should malfunction or break down, grounding provides a path of least resistance for electric current which reduces the risk of electrical shock. The treadmill is equipped with a power cord having an equipment-grounding conductor and a grounding plug. The plug must be inserted into an appropriate outlet that is properly installed and grounded in accordance with all local codes and ordinances.

DANGER

Improper connection of the equipment-grounding conductor can result in a risk of electric shock. Check with a qualified electrician or service person if you are in doubt as to whether the treadmill is properly grounded. Do not modify the plug provided with the treadmill—if it doesn't fit the outlet, get a proper outlet installed by a qualified technician.

Diagram A

Proper grounding plug and power outlet for 120v connection

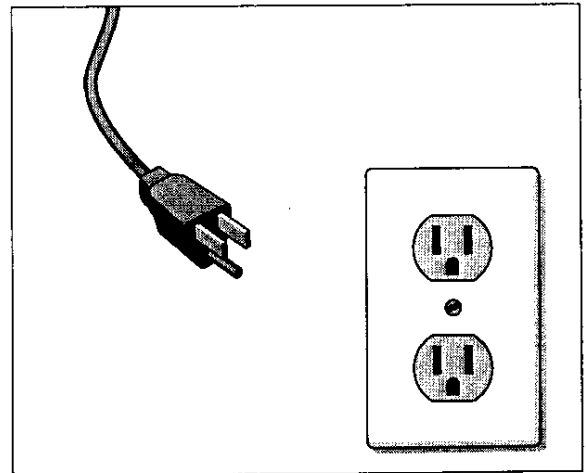

The treadmill is for use on a nominal 120-volt circuit (refer to the **WARNING** below and to the *Installation Requirements* on page 4) and has a grounding plug that looks like the plug illustrated in Diagram A.

WARNING

This product is rated for use on a circuit having a nominal rating of 120 volts, 15 amps, and is factory-equipped with a specific electric cord and plug to permit connection to a proper electric circuit. Make sure that the product is connected to an outlet having the same configuration as the plug. No adapter should be used with this product. If the treadmill must be reconnected for use on a different type of electric circuit, the reconnection should be made by qualified service personnel.

ATTENTION: Haute Tension

Débranchez avant de réparer

Table of Contents

1	Before You Begin	1
	Unpacking the M9.45i Low Impact Treadmill	1
2	Setting Up the M9.45i Low Impact Treadmill	3
	Installation Requirements	3
	Assembly Instructions	3
	Checking the Alignment of the Running Belt	8
3	Using the M9.45i Low Impact Treadmill	9
	Locating the ON and OFF Switch	9
	Using the Magnetic Safety Key	9
	Understanding the Electronic Console	10
	Displays on the Electronic Console	10
	Keys on the Electronic Console	13
	Changing the Display to U.S. Standard or Metric	14
4	Working Out on the M9.45i Low Impact Treadmill	15
	Cooling Down After Your Workout	17
	Pausing Your Workout	17
	Ending Your Workout	17
	Using the Quick Start Feature	18
	Using the Random Course	19
	Creating Custom Courses	19
	Using Your Custom Course	20
	Using the Manual Course Program	21
	Using the Preprogrammed Courses	21
	Using the Interval Courses	22
5	The Precor Smart Rate™ and Cardiologic™ System	23
	Wearing the Chest Strap Transmitter	23
	Understanding Smart Rate	24
	Utilizing the Cardiovascular Course and Fitness Test	24
	Using the M9.45i Cardiovascular Course	25
	Taking the Fitness Test	26
	Using the Weight Loss Program	28
	Correcting Inconsistent Heart Rate Readings	28
	Troubleshooting Heart Rate Error Messages	29
6	Getting the Most Out of Your Workout	31
	How Hard Should I Exercise?	31
	How Long Should I Exercise?	33
	How Often Should I Exercise?	33
7	Maintaining the M9.45i Low Impact Treadmill	34
	Cleaning the Equipment	34
	Storing the Chest Strap	34
	Aligning the Running Belt	35
	Adjusting the Tension of the Belt	36
	Servicing the Treadmill	36
	Power Cord Maintenance	36
	M9.45i Long Term Storage	37
	Displaying the Odometer and Software Version	37
	Obtaining Service	37

1

Before You Begin

This manual explains how to assemble, use, and maintain the M9.45i Low Impact Treadmill. The following conventions are used in this manual:

"Note:" Contains additional information that applies to the preceding text.

"Important:" Indicates information to which you should pay special attention.

"CAUTION:" Indicates steps or information necessary to prevent harm to yourself or damage to the equipment.

"WARNING:" Provides instructions to prevent electrical damage to the equipment and prevent injuries to yourself or others.

"DANGER:" Indicates steps you must take to prevent electrical shock.

CAUTION: This unit weighs over 160 pounds. To avoid injury and to ensure the safety of the unit and yourself, get adequate assistance before dropping the sidewalls of the box and sliding the running bed assembly out of the box. Do not lift the running bed from the box.

Thank you for purchasing the Precor M9.45i Low Impact Treadmill featuring the Cardiologic System. The M9.45i treadmill features several sophisticated and beneficial technologies: *Ground Effects and Integrated Footplant Technology.*

Ground Effects allows the treadmill's running bed to "float" on specially formulated elastomeric springs which cushion impact and control lateral motion without diminishing the bed's lively, responsive feel. Because it's fully suspended, the bed provides optimum shock absorption anywhere your feet land, not just in the center of the running area.

Integrated Footplant Technology (IFT) is a microprocessor-regulated motor control system. This patented technology collects motor and belt speed data, using it to deliver a smooth comfortable feel. It replicates the natural walking and running motion of your feet, by allowing slight, natural speed variations throughout your stride.

The M9.45i Low Impact Treadmill featuring the Cardiologic System is intended for household use and has many unique features which sets it apart from conventional treadmills. To maximize your use of the M9.45i treadmill, please study this guide thoroughly.

Unpacking the M9.45i Low Impact Treadmill

The M9.45i treadmill is carefully tested and inspected before shipment. Precor ships the unit in five pieces as listed below:

- running bed (base) assembly
- handrail/console assembly (targa)
- electronic console display
- owner's manual, limited warranty card, and hardware kit (The hardware kit is shown in Diagram 1.)
- Precor Heart Rate Option (chest strap transmitter)

Optional equipment that you can purchase from your dealer includes:

- Precor Handrails
- Precor Smart Weights
- Handrails

Carefully unpack the pieces of the treadmill and lay them on the floor near the location where you plan to use the treadmill.

Diagram 1

Hardware kit.

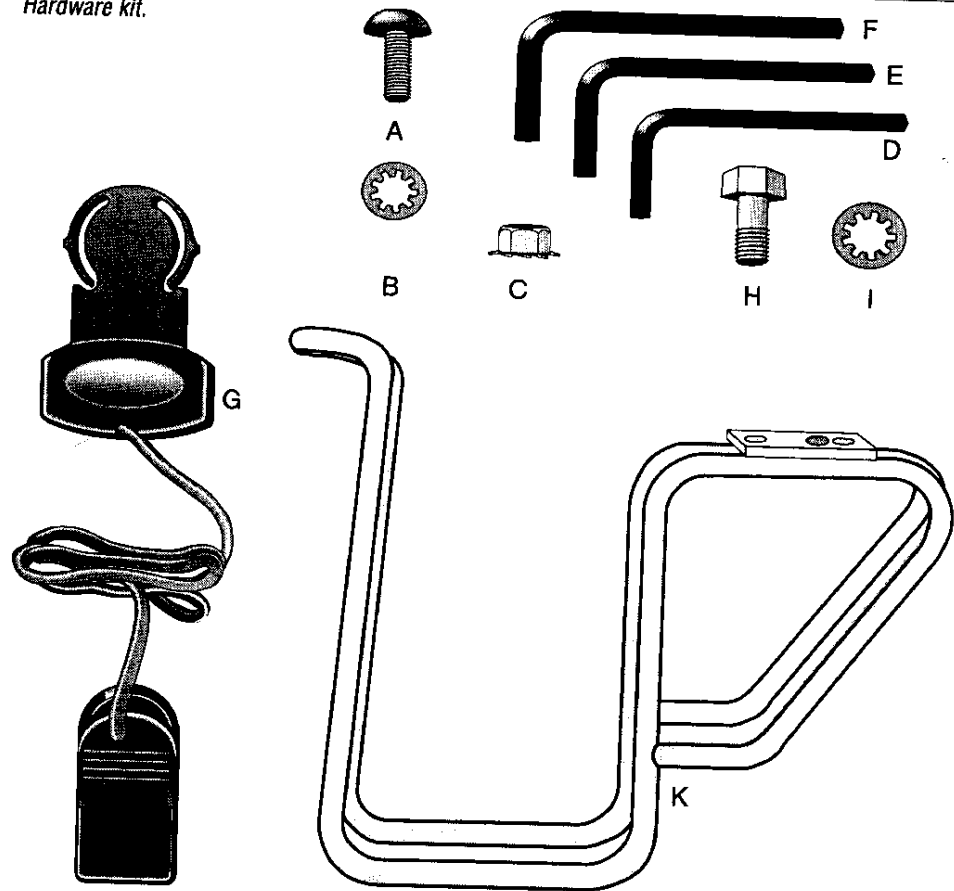

After unpacking the treadmill, open the hardware kit (refer to Diagram 1) and make sure that you have the following items:

- (A) six button head bolts—for mounting the console and water bottle cage
- (B) six small internal star (lock) washers
- (C) four lock nuts
- (D) one 5/32" hex key—console installation
- (E) one 3/16" hex key—hood removal
- (F) one 1/4" hex key—belt and tension adjustment
- (G) one magnetic safety key
- (H) two frame-to-base plate bolts
- (I) two large internal star (lock) washers
- (K) one water bottle cage

If any items are missing, contact the dealer from whom you purchased the treadmill or call 1-800-4-PRECOR for the dealer nearest you.

2

Setting Up the M9.45i Low Impact Treadmill

You do not need any special knowledge or experience to set up a M9.45i. However, you must review and follow the instructions in this manual. If you do not assemble and use the treadmill according to the following guidelines, you could void the Precor limited warranty.

Installation Requirements

Follow these installation requirements when installing the treadmill:

- **Fill out and mail the limited warranty card.** The serial number is printed on a label located underneath the treadmill on the left, rear corner of the running bed. The best time to locate and write the serial number onto the limited warranty card and in this manual is while the treadmill is on its side during the assembly process. Refer to *Obtaining Service*.
- **Set up the M9.45i treadmill on a solid, flat surface.** Do not install the treadmill on deeply padded or shag carpeting due to possible damage to the carpet and machine. If the treadmill is installed in a carpeted area, place a piece of heavy cardboard, plywood, or other solid, smooth, flat surface under the unit to protect the carpet and treadmill. If the floor is not even, the running belt will not track properly. Refer to *Checking the Alignment of the Running Belt*.
- **Locate the treadmill at least 4 feet from walls and furniture.** Be sure to provide ample space in front of the machine to allow easy access to the ON/OFF switch. Open space to the sides and back of the machine makes for a safer mount and dismount and easier belt adjustment.
- **Use the appropriate voltage, dedicated circuit, and grounding as specified on the treadmill.** The M9.45i treadmill is available in a 120-volt model which requires a dedicated circuit. A circuit breaker inside the treadmill also helps to protect the electrical and electronic components from sustained overloads. An integral 3-prong grounded plug provides for your safety and protects the machine.
- **Acquire the appropriate tools.** You will need assistance and a 1/2 inch socket and wrench with a 3 inch extension to complete the assembly of the treadmill.

CAUTION: Do not remove or otherwise bypass the 3-prong plug with an adapter or extension cord in order to use a non-grounded outlet. Electrical damage can occur if the treadmill is connected to an improper power source.

Assembly Instructions

To assist you in the assembly of the treadmill, the items in the hardware kit shown in Diagram 1, correspond to a particular letter in the alphabet. These letters appear throughout the assembly instructions. If necessary, refer to Diagram 1 while performing the steps below.

Ask for assistance to unpack and assemble the M9.45i treadmill. You also need to acquire the following tools *before* assembling the treadmill:

- phillips head screwdriver
- 1/2" socket head wrench with an extension (or 1/2" box wrench)

To assemble the M9.45i treadmill, take the following steps:

1. Unpack the treadmill near the location where you plan to use it. Remove the box that contains the electronic console and set it aside. Take out the packing materials from around the handrail/console assembly and upright supports (targa) and base frame.
2. If you have not already done so, remove the staples from the box and let the side walls drop to the floor. Ask for assistance to move the treadmill out of the box.

CAUTION: Do not try to assemble the treadmill by yourself. Because of the weight of the treadmill and its parts, get additional help from other people.

Diagram 2

Remove cover plate.

- Crossbar
- Mounting plate for the electronic console
- Handrail/console assembly (Targa)
- Phillips head screwdriver
- Handrail clamp
- Cover plate

- Upright support

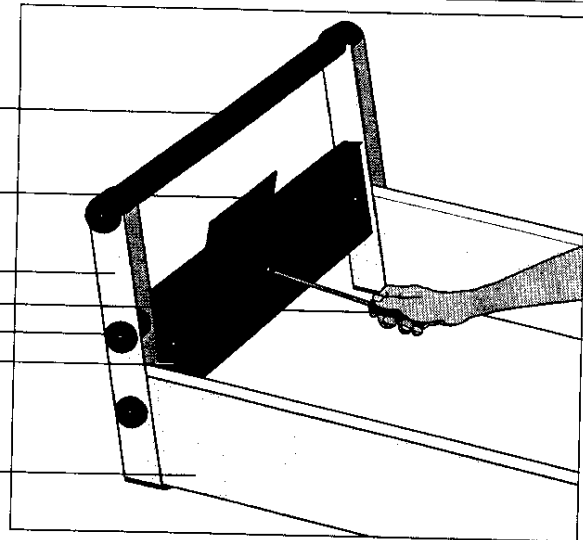

3. Attach the electronic console to the handrail/console assembly before installing the upright supports onto the base of the treadmill. To attach the electronic console, take the following steps:
 - a. To access the ribbon cable you need to remove the cover plate from beneath the upright supports' crossbars. See Diagram 2. Use a Phillips head screwdriver to remove the three screws and detach the cover plate. Set the screws and cover plate aside.

Diagram 3

Attaching the ribbon cable to the electronic console.

- Electronic console
- Ribbon cable receptacle
- Ribbon cable connector

Ribbon cable

Crossbar

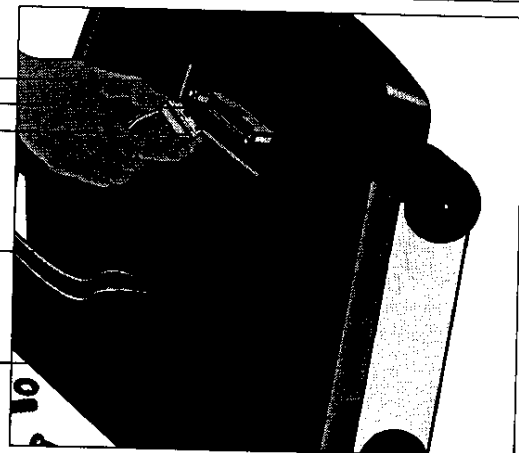

- b. Plug the ribbon cable connector into its receptacle inside the upper electronic console as shown in Diagram 3.

Important: The connector is designed to engage in one direction only. Do not force the connection. Make sure that the flanges on the end of the connection snap into place over the tabs on the receptacle.

- c. Remove the four button head bolts (A) and four internal star washers (B) from the hardware kit. Place a washer on each bolt and set the bolts within easy reach of the handrail/console assembly.

Diagram 4

Mounting the electronic console.

Button head bolt & washer

Mounting plate

Cover plate

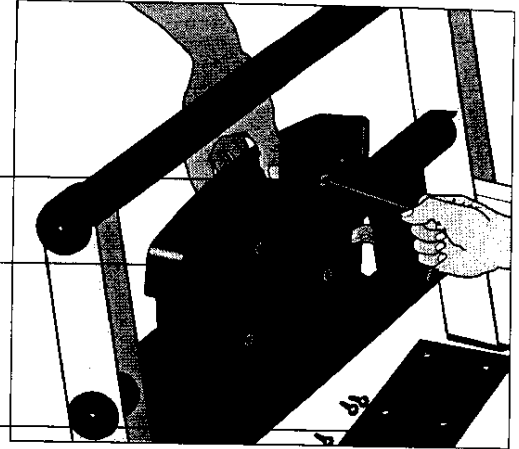

CAUTION: Make sure that the ribbon cable moves freely between the crossbars before tightening the screws. Cable pinched or otherwise damaged by improper installation will not be covered by the Precor limited warranty.

- d. Position the electronic console above the mounting plate. See Diagram 4. Align the mounting holes and insert the four button head bolts (A) and tighten securely using the hex key (E) provided.
 - e. Replace the cover plate removed in step 3a. by aligning the mounting holes and inserting the four phillips head screws. Tighten the screws securely using your screwdriver.
 - f. You are now ready to install the handrail/console assembly onto the base of the treadmill. Ask for appropriate assistance and continue with the following steps.
4. Locate the power switch at the front of the treadmill. Make sure that the power switch is in the OFF position and that the treadmill's power cord is unplugged. Do not assemble the M9.45i treadmill if it is plugged in.
 5. Remove the treadmill's hood using the hex key (F) provided. Unscrew all seven bolts and set them aside. Stand at the front of the treadmill and pull up on the base of the hood to detach it from the treadmill. Set the hood aside.

Diagram 5

Removing the front plate.

Motor

Front plate

Phillips head screwdriver

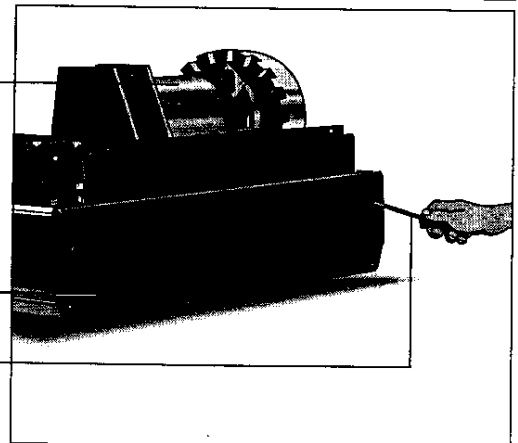

6. Use your phillips head screwdriver to remove the four screws that hold the front plate in place. See Diagram 5. Lay the front plate on the floor in front of the treadmill and set the screws aside.

Diagram 6

Routing the ribbon cable.

Upright support

Ribbon cable

Front plate location

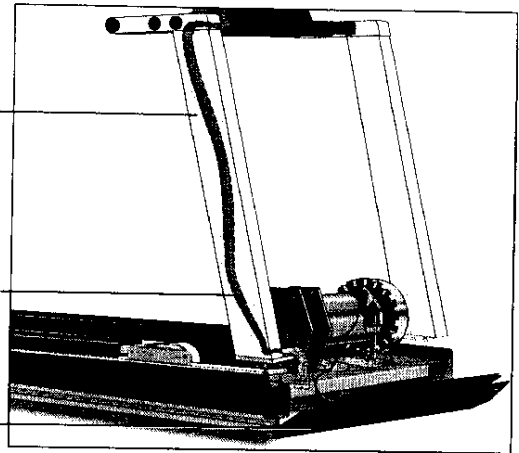

CAUTION: Be sure not to crimp or pinch the ribbon cable as you place the upright supports into position. Cables pinched or otherwise damaged by improper installation will not be covered by the Precor limited warranty.

7. You can now access the mounting plates for the upright supports. Take the following steps to secure the handrail/console assembly and upright supports to the base of the treadmill:
 - a. Position the handrail/console assembly so that both the right and left upright supports align over the base frame. Have your assistant thread the ribbon cable in front of the motor as shown in Diagram 6.

Diagram 7

Installing the handrail/console assembly.

Upright support

Socket head wrench (with an extension)

Base frame

Mounting plates

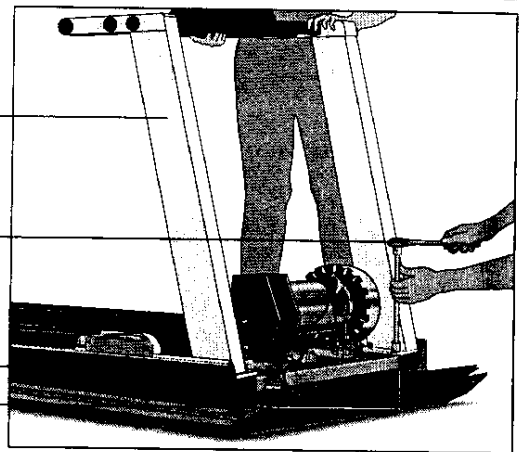

- b. Place a large internal star (lock) washer (I) on each of the two frame-to-base plate bolts (H) and set the bolts within easy reach. Carefully lower the upright supports onto the base frame studs. See Diagram 7. Align the mounting holes for the frame-to-base bolts. While your assistant holds the upright support assembly firmly in place, use your fingers to thread the bolts through the mounting holes and into the base frame.

Note: If you have any difficulty mounting the upright supports onto the base frame studs, you may want to loosen the three upper handrail caps. See Diagram 7. Loosen (but do not remove) the three bolts holding the caps in place on either side of the handrail. This provides more flexibility in mounting the upright supports. Once you secure the upright supports onto the base frame, be sure to retighten all six handrail cap bolts.

- c. Take the four lock nuts (C) from the hardware kit. Use your fingers to thread a nut onto each of the base frame studs.
 - d. To tighten the nuts and bolts, use a 1/2" socket head wrench with an extension (or 1/2" box wrench). Start with the left and move to the right upright support, alternately tightening the nuts and bolts until the four nuts and two bolts are secure and tight against the base frame.

Diagram 8

Connecting the ribbon cable to the lower board.

Ribbon cable receptacle

Ribbon cable connector

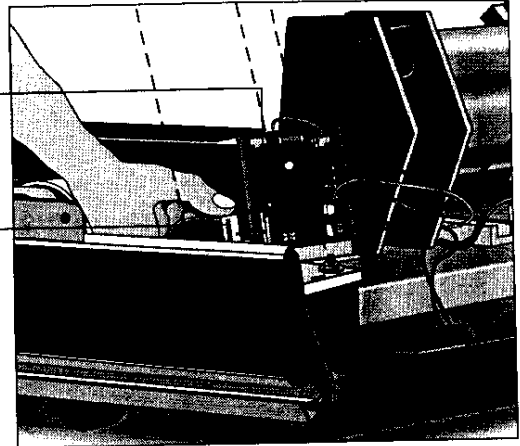

8. Take the ribbon cable that you threaded through the upright support in step 7a. and align the tabs on the connector with its receptacle on the printed circuit board. See Diagram 8. Make sure that all pins are aligned and fully engaged. Do not force the connector into the receptacle.
9. Replace the front plate and hood. Note that handrails are available for this unit. Check with your dealer or see *Obtaining Service* for customer service information.
10. If you need to move the treadmill, ask for assistance. Stand at the rear of the unit. Place your hands underneath one side rail. Have your assistant do the same on the opposite side rail. Together, use proper lifting techniques to lift the rear end of the unit. Stand upright and roll the treadmill on its front wheels to its new location.

CAUTION: Be sure an appropriate number of people help you move the treadmill to its final location. A fully-assembled M9.45i treadmill is very heavy and you might injure yourself if you move the treadmill improperly.

Important: Before you can roll the treadmill on its front wheels, set the incline at 3% or more. Follow steps 1 through 4 in *Checking the Alignment of the Running Belt*, and then, adjust the incline to a minimum of 3%. Turn OFF the treadmill and unplug it before moving it.

Diagram 9

Install the water bottle cage.

Electronic console

Water bottle cage

Water bottle cage mounting location

Bolt (A) with washer (B)

Hex key (D)

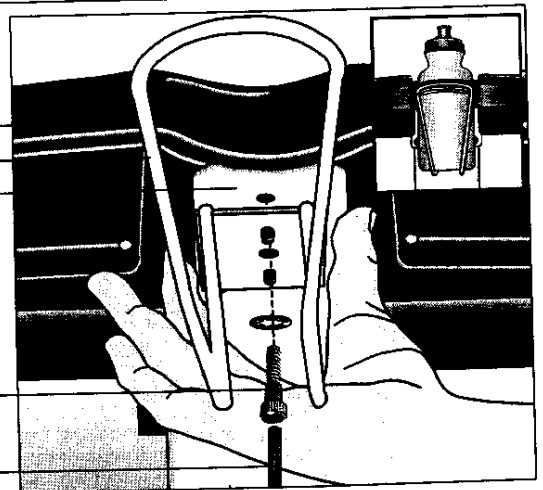

CAUTION: Do not remove or otherwise bypass the 3-prong plug with an adapter in order to use a non-grounded outlet. Do not plug the treadmill into a power transformer in an attempt to adjust the voltage requirements.

11. To install the water bottle cage, place one internal star washer (B) on each of the mounting bolts (A). Position the cage onto the mounting hole locations and insert the bolts. See Diagram 9. Securely tighten the bolts using the 5/32" hex key (D). Place a water bottle inside the cage as shown in the inset in Diagram 9.
12. The treadmill requires a dedicated circuit. Plug the treadmill into a grounded outlet. Make sure that no other product or appliance uses the same circuit as the treadmill.
13. To complete the installation of the M9.45i, see *Checking the Alignment of the Running Belt*.

Checking the Alignment of the Running Belt

CAUTION: Do not walk on the running belt during this procedure.

CAUTION: Keep your feet and hands clear of the treadmill after you turn it ON. The front of the treadmill moves if the incline was not set to zero when the unit was shut OFF. Remain clear of the unit until it has completed the recalibration process.

CAUTION: If you hear or notice any chafing or the running belt appears to be getting damaged, stop the running belt immediately by pressing the STOP key. Consult with your local dealer or Precor representative.

The belt is aligned at the factory before shipment. However, during shipment or by using the treadmill on an uneven surface, the belt might move off center. Proper belt alignment is important because it allows the belt to remain centered and assures smooth operation.

To check the alignment of the running belt, take the following steps:

1. Insert the magnetic safety key into the opening on the electronic console labeled "SAFETY KEY BELOW." Locate the ON/OFF switch at the front of the treadmill and turn ON the treadmill.
2. Stand beside the treadmill and press the QUICK START key. The MANUAL mode course appears in the display. Continue standing next to the treadmill and press the SPEED ▲ key and maintain the running belt at a speed of 2 miles per hour (3 kph).
3. Walk to the back of the treadmill and observe the belt as it moves (watch for a couple of minutes).

If the running belt,...	Then,...
tracks centered on the running surface	the belt is functioning correctly and no adjustment is necessary.
runs or drifts off center	you need to adjust the belt; see <i>Aligning the Running Belt</i> in Chapter 7.

4. Press STOP to stop the running belt.

If the belt is functioning correctly, the M9.45i treadmill is ready to use.

3

Using the Low Impact Treadmill

As simple as using the M9.45i Low Impact Treadmill might seem, you should read this section so that you can use the treadmill safely and effectively. This section of the owner's manual provides the basic information you need for exercising on your treadmill, including the following:

- locating the ON and OFF switch
- using the magnetic safety key
- reviewing features on the electronic console
- changing the unit of measure

Note: Instructions explaining how to use the Precor Heart Rate Option and information regarding the Smart Rate™, Cardiovascular, Fitness Test, and Weight Loss programs appear in the next section: *Precor Smart Rate™ and Cardiologic™ System.*

Locating the ON and OFF Switch

Use the ON/OFF (I/O) power switch to turn the treadmill ON or OFF. This switch is located at the front of the treadmill, near the power cord.

Note: The running belt will not move until the magnetic safety key is inserted into the electronic console. Refer to the instructions below for more information about the safety key.

Using the Magnetic Safety Key

CAUTION: Always attach the magnetic safety key's clip to your clothing before each workout. Use the clip provided on the end of the cord.

The magnetic safety key lets you stop the treadmill's running belt. Use this key in an emergency or when finished exercising. Pulling the key out of the console compartment has the same effect as pressing STOP. To prevent unauthorized use of the treadmill, store the safety key in a safe place.

Diagram 10

Magnetic safety key

Handrail

Route the magnetic safety key and its cord **under** the handrail when you attach the clip to your clothing.

Magnetic safety key

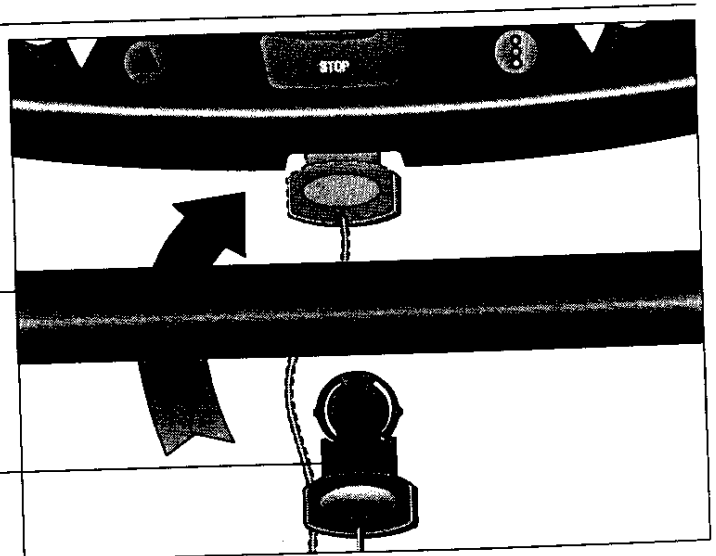

Before you can begin a workout, you must insert the magnetic safety key into the electronic console as shown in Diagram 10. The treadmill's running belt will not move unless the safety key is inserted and secure inside the electronic console.

Important: Do not force the safety key into position, it should slide easily into place within the electronic console compartment. If you force the connection, you could break the safety key and void the **Precor limited warranty.**

Removing the safety key does *not* turn OFF the treadmill. If the safety key becomes dislodged from inside its compartment, the running belt and any incline movement stops and a message "RESET SAFETY SWITCH" scrolls across the display until the safety key is replaced.

Replacing the safety key causes the treadmill to return to its place or position prior to the interruption. However, if the treadmill was moving between inclines when the safety key was removed, you will need to press the INCLINE ▼ or ▲ keys to return the treadmill to its proper incline. You also need to press the Speed ▲ key to start the running belt.

Understanding the Electronic Console

The electronic console lets you control your M9.45i treadmill session. As you work out, the electronic LED display provides constant feedback about your progress. Information about elapsed time, speed, distance covered, degree of incline, and total caloric burn is available at any time. When you use the Precor Heart Rate Option, the Smart Rate™ feature provides visual aids regarding your heart rate. The chest strap that you wear transmits a signal which is picked up by the M9.45i software and displayed numerically (when the Heart Rate indicator is lit) and graphically along the bottom of the left window display. The blinking segment helps you maintain your heart rate in the weight loss or cardiovascular zones.

The M9.45i can also store information about four separate users and recall statistics and information from previous workouts. A separate file that stores data for each of the four users corresponds to a specific user I.D. Previous workout information about your weight, program number, custom course, and workout statistics can be accessed through your user I.D.

Displays on the Electronic Console

Indicator lights appear to show you which feature is being displayed. When you are working out, the electronic console display presents each feature consecutively—this is called scanning. Diagram 11 illustrates the electronic console display. Its features and keys are explained on the following pages.

Diagram 11

*M9.45i
electronic
console
display*

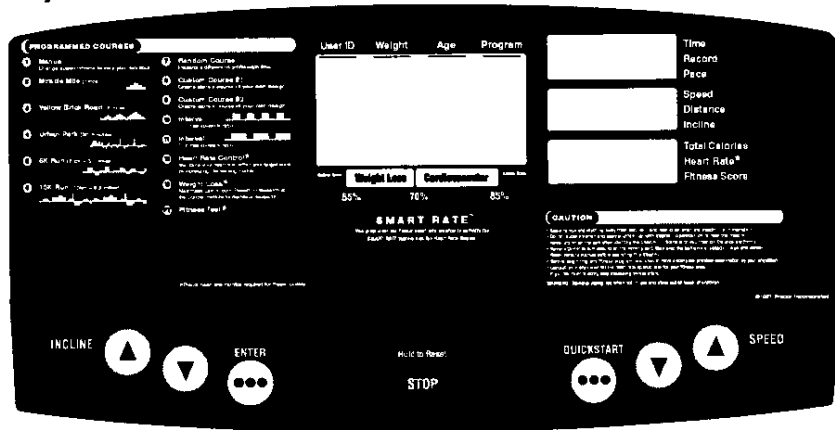

Left Window Displays

The left window displays prompt you to enter specific information before a workout. Small lights next to the words indicate the type of information that is needed. During your workout, the left window displays the course profile and Smart Rate.

Informative messages also scroll across the display. These messages request information and action, or explain problems that may arise while you are using the treadmill. Some problems you can solve (see *Troubleshooting Heart Rate Error Messages*). Other problems require a qualified service technician. If you are unsure about an error message, please call a Precor authorized service center.

Diagram 12

M9.45i displays

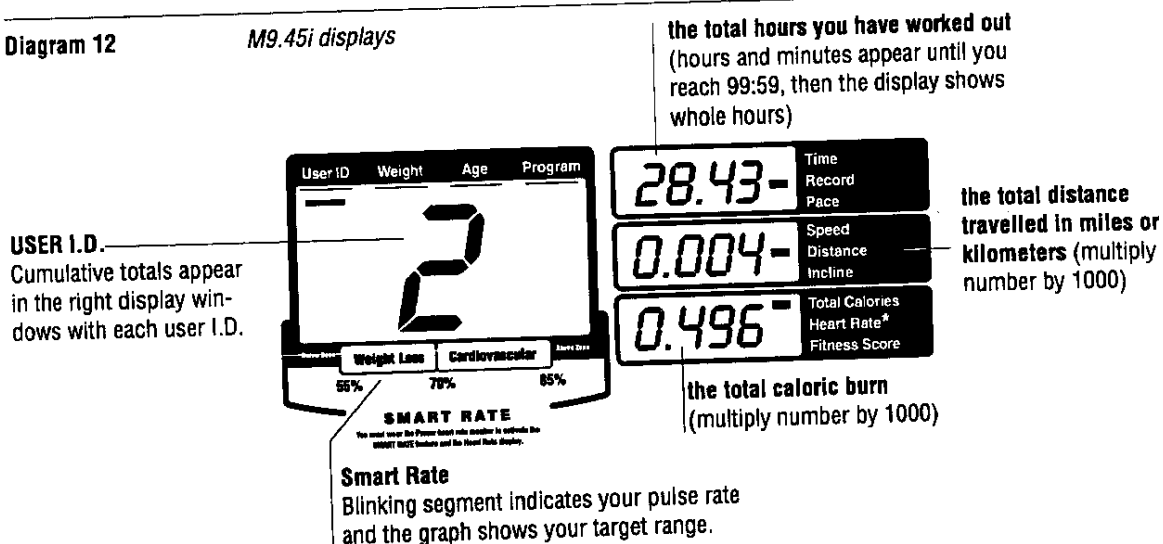

User I.D.: One of four user I.D.'s can appear on the display. Choosing a user I.D. enables the treadmill to identify you and track your cumulative workout statistics. It stores information about your weight, preferred program, cumulative workout statistics, fitness score, perceived level of fitness, and track record. If other people use the treadmill, each person (up to four people) can have their own user I.D. number and personalized workout session.

Every time you begin a workout, the console prompts you for your user I.D. by displaying the user I.D. of the last person who used the treadmill. Press any ▼ or ▲ key, to change the user I.D.

The M9.45i stores accumulated information specific to each user I.D. As you review each user I.D., the cumulative information appears in the three right display windows. See example in Diagram 12.

Note: You can clear the cumulative totals and reset the custom course programs for any user I.D. by pressing and holding the QUICK START and STOP keys for at least 2 seconds when the user I.D. prompt is displayed. Numbers in the mid-right display appear indicating that the software is processing your request. Zeros appear in the right displays when the processing is complete.

To select a specific user I.D., press ENTER and the Weight prompt appears. If you press QUICK START when the Weight prompt is displayed, the software bypasses the remaining setup prompts and displays the course profile associated with the user I.D. A message scrolls by prompting you to begin your workout.

CAUTION: Hold onto the handrails when you press QUICK START. The running belt starts automatically at 1 mph after the display scrolls the message "Belt Starting 3, 2, 1,..."

Note: The QUICK START key operates from existing memory. If no user I.D. information has been entered, the software uses the manual mode course profile and defaults (age = 35, weight = 150 lbs, fitness score = none).

Weight: A weight appears in the display. (If this is the first time you have used the treadmill, a default weight of 150 lbs/68 kg will appear.) Any ▼ or ▲ key lets you change the numerical display. Once the correct weight is displayed, press ENTER to continue to the next prompt.

Note: If you have taken the Fitness Test, your last Fitness Test score also appears in the lower right display window when the Weight prompt appears.

The weight you enter is stored with your user I.D. The next time you use the treadmill, you can use QUICK START to bypass the Weight and Program prompts.

Age: An age appears in the display. (If this is the first time you have used the treadmill, a default age of 35 will appear.) Any ▼ or ▲ key lets you change the numerical display. Once your age is displayed, press ENTER to continue to the next prompt.

Program: Several exercise options are available on the M9.45i treadmill. A label, illustrating the course profiles, appears on the console and provides the different program numbers. The number that appears in the display represents the course profile that you wish to use. Any ▼ or ▲ key lets you change the numerical display. Once the correct program is displayed, press ENTER to continue. For information regarding custom courses, refer to *Creating Custom Courses*.

If you have used the course being displayed, the record time or distance appears in the right display window. Your record distance appears with time-based courses and your record time appears with distance-based courses. For example, if you run or walk a five kilometer course (program number "5"), the record time it took to complete the course appears in the TIME display when the program number "5" is displayed.

Note: When the Program prompt is displayed, you can clear your best performance record by pressing and holding the QUICK START and STOP keys for at least 5 seconds. Zeros appear in the RECORD display when the processing is complete.

Smart Rate: The name given to the bar graph that appears at the bottom of the display. When you wear the Precor Heart Rate Option's chest strap, a blinking segment approximates your heart rate and shows you the zone that your heart rate is in: either weight loss or cardiovascular.

Right Window Displays

The right display windows on the electronic console also use indicator lights to prompt you to enter specific information. The displays provide three separate fields: Time, Record, and Pace; Speed, Distance, and Incline; and Total Calories, Heart Rate, and Fitness Score.

Every few seconds during your workout, new information appears within the window. For example, while you are working out, the Speed display alternately appears with the Distance and Incline displays. A light next to the word identifies which information is being displayed.

Note: The FITNESS SCORE only appears after you complete the Fitness Test. The HEART RATE appears if you are wearing the chest strap transmitter.

TIME: During your workout, a time (00:00) display appears automatically and stops whenever you stop walking or running. As you work out, you will notice that the time starts at zero and counts up when you use manual, distance, or custom courses. However, the time counts down when you use the timed courses. Time appears in minutes and seconds until you reach 90 minutes, then it appears in hours and minutes.

Note: The TIME display alternates between counting up and counting down during the Interval and Weight Loss programs.

RECORD: The record time or distance of your best workout session appears in the right window displays when the Program prompt appears in the left window display. Records are not stored for Manual, Interval, Weight Loss, Cardiovascular course, and Fitness Test programs.

Note: The RECORD only appears prior to the beginning of a workout. If a record time or distance does not exist for the program number being displayed, zeros appear in the RECORD display signifying that you have not yet completed that particular program's course. You have to finish the course before a RECORD is made and stored in memory.

PACE: During your workout, your pace (in minutes/mile or minutes/kilometer) appears when you change your speed.

Speed: Once you begin a workout, the speed at which you are travelling appears in this display. The Speed display is set to scan and alternates with the Distance and Incline displays. In the Cardiovascular Course, the Speed display does not alternately appear with Distance and Incline unless you press the Speed ▼ or ▲ key. Your speed can appear in miles per hour (0.5 to 10 mph) or kilometers per hour (0.8 to 16 kph). If you wish to change the display, you can follow the instructions found in *Changing the Display to U.S. Standard or Metric*.

Note: To display your speed and pace any time during your workout, briefly touch the Speed ▼ or ▲ key. Touching the key briefly will not affect your speed.

Distance: The distance you have travelled appears once you begin a workout. Since the Distance display is set to scan, it alternates with the Speed and Incline displays. Distance can appear in miles or kilometers. If you wish to change the display, you can follow the instructions found in *Changing the Display to U.S. Standard or Metric*.

Note: The odometer resets to 00.00 miles (or kilometers) after your single workout distance exceeds 99.99 miles (161 kilometers). This could only occur when you use manual or interval course programs and exceed 99.99 miles (kilometer) in a single workout.

Incline: The M9.45i treadmill provides inclines from -2% to 12%. You can change the incline and decrease or increase the level of your workout by pressing the INCLINE ▼▲ keys. The Incline display is set to scan and alternates with the Distance and Speed displays.

Note: To display your incline anytime during your workout, briefly touch the INCLINE ▼ or ▲ key. Touching the key briefly will not affect your incline.

TOTAL Calories: During a workout, your caloric burn appears every few seconds and alternates with the HEART RATE display. At the end of the workout, the estimated number of calories burned appears in the display. The calorie calculation is dependent on the weight that you enter during the setup prompts. An accurate weight selection results in a more accurate calorie count.

Note: If you press the QUICK START key while the start-up prompt is scrolling across the display, the software bases the calorie count on a 150 lb (68 kg) person.

HEART RATE: The heart rate display helps you monitor your heart rate and, in the Cardiovascular Course, keeps you within your training zone. You must wear the chest strap transmitter before your heart rate can appear on the display. For more information, refer to the section titled *Precor Smart Rate™ and Cardiologic™ System*.

FITNESS SCORE: A fitness score only appears if you have completed the Fitness Test (program "FT"). The number that appears in the display corresponds to either Tables 1 or 2 found in the section titled *Taking the Fitness Test*. The fitness score is dependent on your age, weight, and cardiovascular fitness. The fitness score appears with the Weight prompt. For more information about your fitness level, refer to *Taking the Fitness Test*.

Keys on the Electronic Console

Each key on the electronic console's keypad provides specific functions. The following information explains the different uses of the keys from left to right. To locate each key, look at the electronic console or refer to Diagram 11.

ENTER: When you turn ON the treadmill, several prompts appear before you start your workout. Each prompt needs to be addressed and then "entered" into the treadmill's memory by pressing the ENTER key.

Note: At the end of a workout, if ENTER is pressed, the USER ID prompt appears.

INCLINE ▼▲ : The INCLINE arrow keys let you decrease ▼ or increase ▲ the treadmill's incline settings from -2% to 12% for easy reference. Briefly touching the INCLINE ▼ or ▲ key during a workout causes the incline level to appear on the display without affecting the incline.

STOP: To pause during your workout, press the STOP key. The running belt slows to a safe stop and the displays on the console freeze allowing you to review your workout statistics. You can also use the STOP key to halt incline movement. See *Pausing Your Workout*.

Note: If you press STOP during the Fitness Test, the test is canceled and you do not receive a fitness score.

Hold to Reset: To exit the Manual and Interval programs, press Hold to Reset for a few seconds. The displays clear, your workout statistics are saved and added to the cumulative totals (unless you entered Manual mode without specifying a user I.D.), and the user I.D. prompt appears. Continue to press Hold to Reset to return to the banner. You can also use this key to exit other courses prematurely. See *Ending Your Workout*.

SPEED ▼▲: The SPEED arrow keys let you decrease ▼ or increase ▲ the speed settings. During a workout, you can decrease or increase the speed of your workout from 0.5 to 10 miles per hour or 0.8 to 16 kilometers per hour. Briefly pressing the SPEED ▼ or ▲ key during a workout causes the current speed and pace to appear on the display without affecting the running belt's speed.

QUICK START: Provides two different options to bypass the setup prompts:

- If you press QUICK START at the Precor banner, a message scrolls across the display "**Belt Starting 3, 2, 1, ...**". The running belt begins moving at 1 mph and the Manual course profile appears in the display. When you press Hold to Reset or stop your workout, the accumulated workout statistics are not stored because the program is not associated with a user I.D.
- If you press ENTER while the Precor banner scrolls across the display, the user I.D. that was last entered into the treadmill's memory appears. Pressing QUICK START, at this point, accesses the last program stored with the user I.D. The display prompts you to press the SPEED ▲ key and begin your workout. At the end of your workout, the accumulated statistics are stored with your user I.D.

CAUTION: Hold onto the handrails when you press the QUICK START key. The running belt begins moving at 1 mph after a warning message scrolls, "**Belt Starting 3, 2, 1, ...**".

If no information is stored in the treadmill's memory for the user I.D. displayed on the electronic console, pressing QUICK START causes the Manual program to appear on the display. For more information, refer to *Using the QUICK START Feature*.

Changing the Display to U.S. Standard or Metric

The M9.45i treadmill can display speed in either miles per hour (mph) or kilometers per hour (kph) and distance in miles or kilometers. When the M9.45i is shipped from the factory, it is set to display to U.S. Standard units of measure (mph and miles). You can easily change this setting by taking the following steps:

Note: The M9.45i treadmill will retain your selection even when it is turned OFF and unplugged. You can change your selection at any time by repeating the following steps.

1. Insert the magnetic safety key into the electronic console.
2. Turn ON "I" the treadmill using the power switch located at the front of the hood.
3. At the Precor banner, press the STOP key, followed immediately by the QUICK START key, then the SPEED ▼ key, and lastly the SPEED ▲ key. (The numbers 5, 6, 7 appear sequentially on the display as you press the associated key.) The prompt, "**PRESS ▲ FOR MPH OR ▼ FOR KPH**" appears on the display.
Important: If the QUICK START key is not pressed within 1 second after pressing the STOP key, the display returns to the Precor banner. You will need to begin again.
4. Any ▼ or ▲ key lets you alternate between the prompts. Press one of the ▼ or ▲ keys to make your selection.
5. Press ENTER to return to the Precor banner.

The changes have been retained in the treadmill's memory. To begin a workout, refer to *Working Out on the M9.45i Low Impact Treadmill*. If you prefer, you can turn OFF the treadmill once you have completed steps 1 through 5.

4

Working Out on the M9.45i Low Impact Treadmill

A variety of exercise options are available on the M9.45i. Refer to the course profiles printed on the label attached to the electronic console. Before using your treadmill, we recommend that you follow the instructions found in this section which include:

- exercising on the treadmill
- cooling down after a workout
- pausing or ending your workout
- using the QUICK START feature
- creating and using custom courses
- using the Manual program
- using the preprogrammed courses
- changing interval courses

When using the treadmill, follow these general guidelines:

- At the beginning of a workout, take several minutes to bring your heart rate into your training zone, shown in Diagram 17 in Chapter 6.
- After your workout, walk slowly for several minutes to cool down your body and lower your heart rate. Use the cool-down feature on your treadmill.
- Before and after a workout, gently stretch your lower body and back to help prevent stiffness or soreness.

Quick Steps to Working Out

1 ▶ Put on the chest strap. (Available through the Precor Heart Rate Option.)

2 ▶ Insert Safety Key.

3 ▶ Turn ON treadmill.

To work out on the M9.45i, take the following steps:

1. If you want your heart rate to appear on the display, or if you plan on using the Cardiovascular Course, Fitness Test, or Weight Loss programs, you will need to put on the chest strap transmitter. Moisten the electrodes before putting the strap on. You can use the spray included with the Precor Heart Rate Option Kit. Refer to *Wearing the Chest Strap Transmitter* to learn how to properly position the chest strap.
2. Insert the magnetic safety key into the electronic console compartment.
3. Locate the ON/OFF switch at the front of the treadmill and turn ON the treadmill. The Precor banner scrolls across the electronic console display.

Note: If the treadmill is ON and the banner is *not* scrolling across the display, press the Hold to Reset key for a few seconds until the display appears blank. Then, release the key and the banner should begin scrolling across the display.

4 Straddle belt.

4. Straddle the running belt with your feet firmly planted on the right and left staging platforms. (Stand close enough to the electronic console so that you can extend your arms and touch the keys.) Attach the safety clip to your clothing near your waistline.

Note: To access the Manual program, press QUICK START while the Precor banner scrolls across the display. For more information, refer to *Using the QUICK START Feature*.

5 Select USER I.D.

5. If you do not use QUICK START, press ENTER and a user I.D. prompt appears. Select one of four user I.D.'s using any ▼ or ▲ key and then press ENTER. The Weight indicator lights.

Note: When "User I.D." appears, the accumulated totals for workout time, number of miles, and total caloric burn appear in the right display windows. You can press QUICK START to bypass the remaining setup prompts and restore the information associated with a user I.D. You can also press QUICK START while the Weight, Age, or Program prompts are displayed. For more information, refer to *Using the QUICK START Feature*.

CAUTION: Hold onto the handrails if you press the QUICK START key. The running belt begins moving at 1 mph after a warning message scrolls, "Belt Starting 3, 2, 1, ..."

6 Select WEIGHT.

6. A weight appears in the left display. Change the weight by pressing any ▼ or ▲ key. (The weight increases and decreases in 5-pound increments.) To increase the accuracy of the calorie count that appears on the display, select a weight that is closest to your actual weight. Press ENTER and the Age indicator lights.

Note: If you have completed the Fitness Test with the Precor Heart Rate Option, your fitness score will appear in the bottom right display window when the Weight and Fitness Score indicator lights are lit.

Important: Before working out, review the information regarding the different M9.25i programs and their operation. Refer to pages 17 through 29.

7 Select AGE.

7. Indicate your age by pressing any ▼ or ▲ key. Press ENTER and the Program indicator lights.

8 Select PROGRAM.

8. To select a particular program, refer to the label on the electronic console. This label provides the program numbers and illustrates the course profiles. To display a program number, use any ▼ or ▲ key. Select the program number by pressing ENTER.

Use the Smart Rate and Heart Rate displays to keep your heart rate in your target zone: *Cardiovascular* or *Weight Loss*.

Important: Before working out, review the information in this manual regarding the different M9.45i programs and their operation.

9 Start working out.

9. Depending on the program you selected, you may be prompted to answer more questions or press SPEED ▲ key to begin your workout. Hold onto the handrail with one hand while you press the SPEED ▲ key with the other hand. Step onto the running belt while the speed is at or below 1 mph (1.6 kph). Once you are comfortable with the walking or running speed, you can remove your hands from the handrail.

To purchase Smart Weights, call your local dealer.

(Pause)

Note: To pause during your workout session before finishing the selected program, press the STOP key. The displays on the console freeze. See *Pausing Your Workout* or *Ending Your Workout* for more information.

10 End workout.

10. When the end of the course profile appears, you are nearing the end of your workout session. Once the session ends, your workout statistics are saved. Your workout statistics remain on the display while the software initiates the cool-down program. When the software begins the automatic cool-down period, TIME counts up from zero. The Distance and Calorie count continue to accumulate and are added to your cumulative totals when you STOP the cool down. For more information, refer to *Cooling Down After Your Workout*.

(Cool down)

Note: Use the ▼ or ▲ keys to decrease or increase the Speed and Incline during your cool-down period.

11 Review workout statistics. Add stats to cumulative totals.

11. Once you have finished your workout and cool down, press STOP. To add the accumulated cool-down statistics (Distance and Calories) to your workout statistics, continue to press Hold to Reset. The user I.D. prompt appears. When the running belt comes to a complete stop, straddle the running belt, remove the safety clip from your clothing, and step off the treadmill.

(Press Hold to Reset)

12 Turn OFF treadmill.

12. Turn OFF the treadmill using the ON/OFF switch.

13 Remove Safety Key. Store in secure place.

13. To prevent unauthorized use, remove the magnetic safety key from inside the console and store it in a safe place.

Cooling Down After Your Workout

Cooling down after your workout helps reduce muscle stiffness and soreness by transporting excess lactic acid out of the working muscles. It also helps your heart rate return to its normal (non-exercising) state.

The M9.45i treadmill automatically incorporates a cool-down period into your workout. (The automatic cool-down does not occur when you are using Manual, Interval, or Random programs.) When the end of the course profile scrolls past on the display, a message appears stating that you have reached the end of the course and the cool-down period is about to begin. Your cumulative workout statistics are saved and any new records are stored with your user I.D. The running belt slows down and the incline returns to 0% to allow a cool-down period in which you can slow your heart rate. The manual course profile appears in the display. You can adjust the speed and incline by pressing the ▼ or ▲ keys.

Note: Speed remains constant if you were already at or below 2 mph (3.2 kph).

During your cool down, the displays on the console continue to appear. The Distance and Calorie statistics displayed during your cool down are saved in the software's memory. The Time display lets you know how long you have been in the cool-down period.

To end a cool-down period, press Hold to Reset for a few seconds. The software adds your cool-down statistics to the cumulative totals, the running belt slows to a gradual stop, and the user I.D. prompt appears.

Pausing Your Workout

You can pause at any time during your workout. Use this feature to rest or take a short break (less than 10 minutes).

To pause while working out, press the STOP key. Hold onto the handrail while the running belt stops so you can safely step off the treadmill. Your workout statistics freeze and remain displayed on the console until you resume your workout.

If you pause for more than ten minutes, the computer adds your workout statistics to the cumulative totals and Precor banner scrolls across the display. Do not rely on the Pause feature as a way to end your workout. If you wish to end your workout, follow the instructions in the next section titled, *Ending Your Workout*.

Important: If you press STOP (to pause) when taking the Fitness Test (program "FT"), you cannot continue the test. The Fitness Test becomes invalid and you do not receive a fitness score.

To resume your workout, straddle the running belt, attach the safety key clip to your clothing, press the Speed ▲ key to start the running belt, hold the handrail, and step onto the running belt while the speed is at or below 1 mph. Your workout statistics continue from where you left off. Continue to press the Speed ▲ key to increase the speed to a comfortable level. Once you are comfortable with the walking or running speed, you can remove your hands from the handrail.

Ending Your Workout

To end your workout, take the following steps:

1. Hold onto the handrail and press the STOP key. The running belt slows to a gradual stop. The displays on the console freeze which lets you review your workout statistics.
2. Continue to press STOP (Hold to Reset) for a few more seconds and the Precor banner appears. The software adds your workout statistics to the cumulative totals.
3. Straddle the running belt and step off the treadmill.
4. Turn OFF the treadmill. To access the same program the next time you workout, press QUICK START when your user I.D. appears.
5. To prevent unauthorized use, remove the magnetic safety key from inside the electronic console and store it in a safe place.

Using the QUICK START Feature

The words "quick start" imply that you can start your workout immediately. Once you insert the magnetic safety key and attach the safety clip to your clothing, pressing QUICK START while your user I.D. is displayed lets you bypass the remaining setup prompts and display the course profile that you last used while working out on your treadmill. The running belt starts automatically after the warning message "Belt Starting 3, 2, 1,..." scrolls across the display.

CAUTION: The QUICK START key automatically starts the running belt after the warning message appears, "Belt Starting 3, 2, 1,..." Always hold onto the handrail with one hand and use the other hand to press QUICK START or any other keys on the console. Do not release your grip on the handrail until you are comfortable with the movement and speed of the running belt.

Since the treadmill's software stores all workout information with your user I.D., the weight, program number, age, fitness score, perceived level of fitness, duration/distance of workout, and record time are reactivated and restored into the treadmill's memory. The last program you used appears as the course profile on the display. You can then begin your workout.

Note: If the last program used was a custom course, pressing QUICK START while your user I.D. is displayed causes the custom course profile to appear. The software assumes you want to use (walk or run) the course, not customize it.

If you press QUICK START while the Precor banner scrolls across the display, the software immediately enters Manual mode. The manual course profile appears on the display. Accumulated workout statistics are not stored with any particular user I.D. When you end your workout by pressing STOP or Hold to Reset the workout statistics are not saved or added to any cumulative totals. Refer to *Using the Manual Course Program*.

You can press QUICK START while the Precor banner scrolls across the display, or after the user I.D., weight, age or program prompts. Review the chart below to understand the different aspects of this feature.

Press QUICK START at the,...	Because,...
PRECOR banner	you want to bypass the setup prompts and enter manual mode. Manual mode has no time limit and lets you regulate the speed and incline of your workout. When the manual course profile appears on the display, the Weight defaults to 150 lbs (68 kg). Workout statistics are not saved.
USER I.D. prompt	you have multiple users in your household or you have used more than one user I.D. to customize your workout. Identifying the user I.D., prior to pressing QUICK START, guarantees that the appropriate workout program and user I.D. information will be restored. Workout statistics are added to the cumulative totals.
WEIGHT prompt	your weight has changed significantly (more than 5 lbs/2 kg) since you last programmed the treadmill, you may want to reenter it to receive a more accurate caloric burn display.
AGE prompt	you had another birthday! Change and ENTER the numeric display prior to pressing QUICK START so that your Fitness Test score will be accurate.
PROGRAM prompt	you want to use the program number that is being displayed. If you want to use a different program. Use the ▼ or ▲ keys to change the program number and press ENTER. The new program number writes-over the existing number and is saved with the user I.D.

Note: Any prompts that appear after the Program selection prompt require your input before you can proceed. You cannot use the QUICK START feature beyond the Program selection prompt.

CAUTION: Hold onto the handrails when you press QUICK START. The running belt starts automatically at 1 mph after the display scrolls the message "Belt Starting 3, 2, 1,..."

Using the Random Course

Choosing the Random course "7" provides variable course profiles. Each course profile is "randomly" selected by the M9.45i software. Every time a Random course is selected, a different course profile appears. The Random course has no time or distance limit, you need to press STOP when you have completed your workout. The 1-minute segments that appear in the course profile maintain a set incline that you can override using the INCLINE ▼ or ▲ keys. Note that a cool-down period does not automatically occur when you press STOP to end your workout. You will need to access Manual mode to cool down.

Creating Custom Courses

You can program the M9.45i treadmill and create your own course profiles using the two custom courses (program numbers "8" and "9") that are available with each user I.D. You create the custom courses as you work out, determining the incline for each 0.1 mile segment along with the 8-mile maximum course length. Once you complete your workout, the course is stored in memory and can be automatically recalled using the same user I.D. and program number.

Important: You cannot use the QUICK START feature to redesign a custom course. If you press QUICK START to access programs "8" or "9," the software assumes you want to "use" the course not "modify" it.

To create a custom course, take the following steps:

1. Follow steps 1 through 4 on page 15, *Quick Steps to Working Out*.
2. Press ENTER to proceed through the User I.D., Weight, and Age prompts.
3. At the Program prompt, your record time appears in the Record display and the length (in miles/kilometers) of the custom course appears in the Distance display. Use any ▼ or ▲ key to select program course number "8" or "9." Press ENTER. A prompt "USE COURSE" appears and scrolls across the display.

Note: The following instructions (steps 4 through 8) assume that you plan on creating a new course profile. However, if you want to use the custom course being displayed, press ENTER, begin your workout, and refer to the section titled, *Using a Custom Course*.

4. Any ▼ or ▲ key lets you alternate between the "use" or "customize" scrolling prompts. Press one of the ▼ or ▲ keys till the prompt "CUSTOMIZE COURSE" scrolls across the display. To begin programming your custom course, press ENTER. A blinking 0.1 mile cell indicates your position on the course profile that appears in the left display window.

Important: Clear an existing course profile and its course record by simultaneously pressing the QUICK START and STOP keys for at least 5 seconds. The course profile reverts to one blinking cell. Be cautious about performing this procedure. Once you clear an existing course profile, you cannot retrieve it.

5. Hold onto the handrail and press the Speed ▲ key. Step onto the running belt while the speed is at or below 1 mph (1.6 kph) and begin walking. Use the INCLINE ▼▲ keys to change the course profile as you walk. The first time you customize programs "8" or "9," the course profile appears as a 0.1 mile blinking cell at 0% incline.

Important: Be sure to walk while customizing the course profile. If you want, you can save your custom course and run it during your next workout. Refer to *Using a Custom Course*.

6. As you work out through the 8-mile course, you can continue to change the incline by using the INCLINE ▼▲ keys to change the cell that is blinking. You cannot "go back" to a cell once you move beyond it. However, you can pause by pressing STOP. Prompts appear and scroll across the display:
 - To save your changes and quit — press ENTER. This saves the course profile up to the point (mile or kilometer) where you stopped and resets any previous course profile record to zero. A confirming message scrolls across the display.

Note: If an existing course profile extended beyond the cell where you stopped, it will be discarded.
 - To discard changes and quit — press Hold to Reset for more than 5 seconds. This discards the changes you made to the course profile.

Note: If you were "writing over" an existing course profile, that course is restored.
 - To continue — press Speed ▲ to start the running belt and let you continue from where you left off. Be sure to hold onto the handrail before pressing this key.
7. If you continue to customize the course profile for the maximum distance of 8 miles, a prompt appears and scrolls across the display explaining that you have reached the end of the course. The running belt stops, the incline returns to 0%, and prompts appear requesting that you save or discard your changes.
8. To save your changes, press ENTER. To discard your changes, press STOP for more than 4 seconds. To use your custom course, refer to the instructions in *Using a Custom Course*.

When you have saved or discarded your custom course changes, you can work out and use the same course over and over by entering the associated user I.D. at the user I.D. prompt and pressing QUICK START. The M9.45i can store two custom courses and their associated speeds and inclines per user I.D.

Using Your Custom Course

The two custom courses (programs "8" and "9") that are available with each user I.D., let you preset the incline in 0.1 mile segments along a specific course that can be up to 8 miles in length.

Note: Prior to using a custom course, you must create it by following the steps found in the previous section, *Creating Custom Courses*.

To use a custom course, follow steps 1 through 5 in the previous section, *Creating Custom Courses*, and then take the following steps:

1. At the "Use Course" prompt, press ENTER. The course profile appears in the display.

Note: The course profile appears in 0.01 mile segments which is different from the 0.1 cells that appear in the customizing course mode. However, all incline changes made to the course profile in the custom course mode are still intact and take effect at the distance specified.
2. Hold onto the handrail and press the Speed ▲ key. Step onto the running belt while the speed is at or below 1 mph and begin walking. Continue to press the Speed ▲ key until you are comfortable with the pace. When you are comfortable with the speed of the running belt, you can let go of the handrail.

Note: During your workout, you can adjust the incline, but the changes are not saved. To pause during your workout session before finishing the selected program, press the STOP key. The displays on the console freeze. See *Pausing Your Workout or Ending Your Workout* for more information.
3. When the end of the course profile appears, you are nearing the end of your workout session. Once the session ends, your workout statistics are saved. The software begins an automatic cool-down period and adds your workout statistics to the cumulative totals. For more information, refer to *Cooling Down After Your Workout*.

Note: Use any ▼ or ▲ keys to change the speed and incline during your cool-down period. During this cool-down period, the workout statistics continue to appear.

CAUTION: The treadmill may automatically change incline when you enter a program. Stay clear of the lift mechanism and hood area until the treadmill has completed its recalibration.

4. Once you have finished your workout, press STOP. To add the accumulated cool-down statistics (Distance and Calories) to your workout statistics, continue to press Hold to Reset. The user I.D. prompt appears. When the running belt comes to a complete stop, straddle the running belt, remove the safety clip from your clothing, and step off the treadmill.
5. Turn OFF the treadmill using the ON/OFF switch.
6. To prevent unauthorized use, remove the magnetic safety key from inside the electronic console and store it in a safe place.

Using the Manual Course Program

Manual mode lets you use the M9.45i treadmill for an indefinite period of time and control the speed and incline in each individual cell of the course profile. All of your workout statistics are compiled and stored with your user I.D.

Note: Workout statistics are not stored when you press QUICK START while the PRECOR start-up prompt is scrolling across the display.

You can choose the Manual course program in two different ways:

CAUTION: Hold onto the handrails when you press QUICK START. The running belt starts automatically at 1 mph after the display scrolls the message "Belt Starting 3, 2, 1,.."

- pressing QUICK START while the Precor start-up prompt scrolls across the display bypasses the remaining setup prompts and displays the manual course profile. The weight setting defaults to 150 pounds (68 kg) so all calorie calculations and their associated displays are based on a body weight of 150 pounds (68 kg). For more information, refer to *Using the QUICK START Feature*.
- selecting your user I.D., weight, and program "1." The manual program then becomes associated with your user I.D. and, at the end of your workout, your workout statistics are added to your cumulative totals. At your next workout, select your user I.D. and press QUICK START to access this same program.

When you choose the Manual program, the program's course profile appears in the left display window and shows a flat constant course. The INCLINE ▼ or ▲ keys change the incline. The SPEED ▼ or ▲ keys affect the speed of the running belt.

As you proceed through your workout, a blinking cell represents your position in the course.

Important: You need to press STOP to end a workout in manual mode. Otherwise the course continues on indefinitely—there is no time or distance limit in manual mode. After you STOP, press Hold to Reset for a few seconds to save your workout statistics. The workout statistics will be applied to whatever user I.D. appeared during the setup prompts. Workout statistics are not saved if you pressed QUICK START at the PRECOR banner.

Using the Preprogrammed Courses

The M9.45i is equipped with five preprogrammed courses that vary in distance, time, and incline. Refer to the label on the electronic console for a representation of the course profiles.

CAUTION: The treadmill may automatically change incline when you enter a program. Stay clear of the lift mechanism and hood area until the treadmill has completed its recalibration.

To use the preprogrammed courses, follow the steps in *Working Out on the M9.45i Low Impact Treadmill*. At the program prompt, enter any program number "2" through "6."

During your workout, you can adjust the speed, but the incline is preset as shown in the course profile. You can override and adjust the incline any time using the INCLINE ▼ or ▲ keys.

With the completion of your selected course, the treadmill enters a cool-down period (see *Cooling Down After Your Workout*) and your best performance (time or distance) is saved and recorded. The next time you workout, it appears as the Record display when the Program prompt appears. Your best performance is associated with a particular program number and only appears with the Program prompt if you have previously completed the program.

Important: If you end your workout prior to completing the course, you need to press Hold to Reset for several seconds to add your workout statistics to the cumulative totals associated with your user I.D. If you turn OFF the treadmill while in program mode, the workout statistics will not be saved with your user I.D.

Using the Interval Courses

The interval courses are among the best for conditioning your cardiovascular system. The courses are designed to raise and lower your heart rate in a repeating fashion for an indefinite period of time. Refer to *Using Smart Rate* and *Getting the Most Out of Your Workout* to learn about your target and training zones.

The interval courses on the M9.45i treadmill allow you to set the rest and work intervals according to your training regimen. You set the speed and incline for the first rest and work intervals (first two segments of the course) and the software takes over from there, repeating the intervals throughout the course until you press the STOP key.

CAUTION: The treadmill may automatically change incline when you enter a program. Stay clear of the lift mechanism and hood area until the treadmill has completed its recalibration.

To use the interval courses, follow the steps in *Working Out on the M9.45i Low Impact Treadmill*. At the Program prompt, enter program number "10" for a one minute rest/one minute work interval or enter program number "11" for a one minute rest/two minute work interval.

To set the interval for a course, take the following steps:

1. When the course profile appears in the left window display, continue to straddle the running belt while you press the SPEED▲ key. Step onto the running belt while the speed is at or below 1 mph (1.6 kph). Hold onto the handrail with one hand until you have completed setting the rest and work speeds for the course. Be sure you are comfortable with the speed of the running belt before you release your grip from the handrail.
2. While the cell is blinking at the top of the first rest interval, press the SPEED▼▲ keys to set your rest speed. Then, press the INCLINE ▼▲ keys to choose an appropriate incline.

Important: You have one or two minutes, depending on the segment time, to set the speed and incline settings for your rest or work intervals.

3. When the work interval begins to blink, use the SPEED▼▲ keys to set your "work" speed. Choose an appropriate incline by pressing the INCLINE ▼▲ keys.

Note: A 30 second count down occurs at the appropriate time and signals the end of a particular time interval. The count down appears in the TIME display.

After you set the speed and incline for the first two intervals of the course profile, the treadmill's software takes over and continues repeating the rest and work intervals, throughout the remaining portions of your workout, at the levels you selected.

Note: Anytime during your workout, you can change the rest and work interval levels by using the SPEED▼▲ or INCLINE ▼▲ keys. The treadmill's software reprograms the remainder of the course profile to the newly specified rest and work intervals.

4. At the end of your workout, press Hold to Reset for several seconds to store the incline settings with your user I.D. and save the Time, Distance, and Calories to your cumulative totals. The interval course inclines will be preset next time you select the same user I.D. and program number. Note that the running belt speeds cannot be saved and need to be reentered during every session.

Important: You need to press STOP to end a workout in interval mode. Otherwise the course continues on indefinitely—there is no time or distance limit in interval mode. Press Hold to Reset for a few seconds to save your workout statistics with your user I.D. If you turn OFF the treadmill while in interval mode, the workout statistics will not be saved with your user I.D.

5

Precor Smart Rate™ and Cardiologic™ System

The Precor Cardiologic™ System has many unique features. Before you use the chest strap transmitter, Cardiovascular Course, Fitness Test, or Weight Loss program, please study this section thoroughly. Included in this section are the following:

- wearing the chest strap transmitter
- understanding Smart Rate
- utilizing the cardiovascular course
- taking the Fitness Test
- using the weight loss program
- correcting inconsistent heart rate readings
- troubleshooting heart rate error messages

Important: If you do not use the Precor Heart Rate Option according to the guidelines found in this manual, you could jeopardize the accuracy of your heart rate readings or void the manufacturer's limited warranty.

Wearing the Chest Strap Transmitter

The Precor Heart Rate Option is a completely wireless system. A built-in receiver displays continual feedback about your heart rate when you wear the transmitter strap around your chest. No bulky wires or cables interfere with your movements.

The wireless chest strap contains the electrodes that transmit your heart rate (pulse) to the receiver. To get an accurate reading, the electrodes need to be *moist* and in *direct contact* with your skin. *Be sure to wear the chest strap underneath your clothing.*

Take the following steps to put on the chest strap:

Diagram 13
Determine proper length.

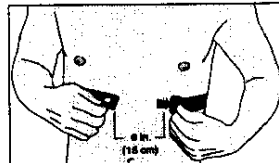

Diagram 14
Moisten electrodes. If needed, use the spray included with the Precor Heart Rate Option.

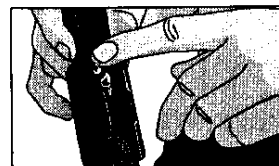
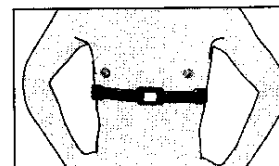

Diagram 15
Buckle chest strap.



1. Adjust the tightness of the chest strap by sliding the buckle along the strap.
2. Determine the length of the strap by wrapping it around your chest. Without stretching the strap, check the distance between the two ends of the strap. For a snug fit, the ends of the strap should be about 6 inches (15 cm) apart. See Diagram 13.
3. Remove the strap from around your chest and carefully dampen the electrode strips with tap water as shown in Diagram 14 or use the Precor spray. Do not use deionized water. To function properly, the electrodes need the salts and minerals found in non-purified water. During your workout, your perspiration keeps the electrodes moist.
4. Buckle the strap around your chest. The strap should feel snug, not restrictive. Make sure that the transmitter lies horizontally across your chest and is centered in the middle of your chest. See Diagram 15.

Note: The chest strap transmitter has a one-year warranty. Some straps have a replaceable battery and other straps are disposable. To change the battery, refer to *Changing the Battery in the Chest Strap*.

With the proper adjustment of the chest strap, you are ready to begin using the Precor Heart Rate Option.

Understanding Smart Rate

The M9.45i software incorporates the latest in cardiac monitoring to provide Smart Rate™—a visual aid that lets you know what your heart rate is doing. When you use the Precor Heart Rate Option, the graph on the display lights up with colored cells to show your exercise intensity. The blinking cell indicates where you are within that zone.

Smart Rate simplifies the correlation between heart rate and exercise. You don't have to stop concentrating on your workout to find your pulse anymore. It is displayed right in front of you along with the Smart Rate zone.

When you use the Cardiovascular Course or Weight Loss Program, the M9.45i software monitors and maintains your heart rate in the target zone best suited for your specific needs.

Smart Rate uses your age and your maximum aerobic heart rate to calculate a zone (weight loss or cardiovascular) and places the blinking cell that symbolizes your heart rate in the correct area. Use Smart Rate during your workout with any M9.45i program to maximize your weight loss or cardiovascular fitness regimen.

CAUTION: Keep in mind that the Smart Rate zones are approximations. Always check with your physician to learn what the appropriate heart rate is for **your** level of fitness. Do not push yourself beyond the recommended range.

When you maintain your heart rate between 70% and 85% of your maximum aerobic heart rate, you are improving your overall cardiovascular/cardiopulmonary fitness level. If you maintain your heart rate between 55% and 70% of your maximum aerobic heart rate, you are burning enough calories that, when continued on a regular basis for 30 minutes or more, provides the greatest fat-burning (weight loss) benefits.

Utilizing the Cardiovascular Course and Fitness Test

The Precor Cardiovascular Course and the Fitness Test have been designed from research conducted at the world-renowned Cooper Institute for Aerobics Research. Both the program and the test must be used in conjunction with the Precor Heart Rate Option.

You can use the Cardiovascular Course to maximize your aerobic workout. Once you start the program, the M9.45i software automatically adjusts the incline (or prompts you to adjust the speed, if necessary) to keep your heart rate within the cardiovascular heart rate zone.

Note: You can override the incline any time during your workout, but doing so may change the target zone that your heart rate is in.

You can take the Fitness Test to determine your cardiovascular fitness level. The Fitness Test measures the maximum amount of oxygen the body can use for energy production during exercise. The higher the amount of oxygen that the body can use, the greater your ability to exercise for prolonged periods without tiring.

The Fitness Test determines heart rate response to varying levels of exercise. It's a simple procedure that reveals valuable information about your current fitness level. Your results classify you in one of three fitness categories (see Tables 1 and 2 in *Taking the Fitness Test*), which are based on the Cooper Institute's eight-year study of over 13,000 men and women.

Before using the Cardiovascular Course or performing the Fitness Test, take time to read the following guidelines.

- Consult with your physician before engaging in any vigorous exercise. Do not use the Cardiovascular Course or perform the Fitness Test until authorized by your physician.
- Slow down and stop the test immediately if you experience any pain or abnormal symptoms.
- The ideal time to perform the Fitness Test is in the morning, prior to any physical exertion, and in a well-ventilated room with a temperature around 72 degrees Fahrenheit (22 degrees Celsius).
- Gently stretch your lower body and back before and after the test to help prevent stiffness or soreness.
- Know your heart rate (pulse) and your physician-recommended heart rate training zone. Individual heart rates vary according to several physiological factors and may not correspond directly with the tables provided.

- You should not use the Cardiovascular Course or take the Fitness Test if you are taking any medications that either speed up or slow down your heart rate. Since the test is based on your heart rate response during varying levels of exercise, medications can invalidate the test.
- Do not drink caffeine or smoke cigarettes for at least three hours prior to the test. Cigarettes and caffeine can elevate your heart rate.
- Do not carry on a conversation while taking the Fitness Test.
- Always face forward on your treadmill and only use the handrails for balance. *Do not use the handrails to support your weight.*
- You must complete at least two stages of the Fitness Test before you can receive a fitness score. The Fitness Test stops automatically if:
 - a. You reach your maximum heart rate (maximum heart rate equals 220 minus your age).
 - b. You meet or exceed 85% of your maximum heart rate at the end of Stage 1.
 - c. You meet or exceed 70% of your maximum heart rate at the end of Stages 2, 3, 4, 5, or 6.
- Keep in mind that you are working with very sensitive equipment and upper body movement should be kept to a minimum.
- Do not carry weights (or Precor Smart Weights) while taking the Fitness Test.
- After putting on the chest strap, turn the treadmill ON and position yourself on the running belt for at least 15 seconds. This allows the treadmill to detect the transmitter.
- While using the Cardiovascular Course or performing the Fitness Test, face the electronic console and stay within 3 feet of it. If you move outside of the 3-foot range, the receiver might have difficulty picking up your heart rate signal.
- Take the Fitness Test again, after a period of rest, if you feel that your heart rate or fitness score is inconsistent.
- A cool-down period, which helps lower your heart rate, has been incorporated into the Fitness Test. A warm-up and cool-down period is also part of the Cardiovascular Course.

Using the M9.45i Cardiovascular Course

The M9.45i Cardiovascular Course monitors your heart rate and automatically maintains it within your cardiovascular zone. Your training or target zone is based on your age and level of fitness.

Note: You must wear the Precor chest strap to use the Cardiovascular Course.

CAUTION: Always check with your physician to learn what the appropriate heart rate is for your level of fitness. Do not push yourself beyond the recommended range.

To use the Cardiovascular Course follow the steps in *Working Out on the M9.45i Low Impact Treadmill* and choose program number "12" at the Program prompt. The following occurs:

1. The software verifies that it detects the heart rate signal and a prompt asks you to specify a workout time. The system defaults to 30 minutes if no previous record exists. You can select a range of time between 10 and 95 minutes in 5-minute increments. Use the ▼ or ▲ keys to change the display. Press ENTER.
2. Hold onto the handrail. The running belt begins moving after the warning message "Belt Starting 3, 2, 1,..." appears.
3. The treadmill provides a 3-minute warm-up period before entering the actual Cardiovascular Course. Use the SPEED ▼ or ▲ keys to adjust the speed to a comfortable level. Once your heart rate moves into the target zone or the 3-minute warm-up ends, the Cardiovascular Course begins.
4. To keep your heart rate within the target zone, the software automatically checks the incline every thirty seconds and makes adjustments when necessary. The treadmill also prompts you if your heart rate is not within the target zone.

Note: During the program, the INCLINE ▼ ▲ keys do not affect the treadmill's incline. Instead, use the INCLINE ▼ ▲ keys to change your target zone. Prompts scroll across the display notifying you of the changes.

CAUTION: Hold onto the handrail. If the treadmill is not already at 0% incline, it automatically returns to 0% incline.

Note: If your heart rate cannot be detected or no heart rate information is transmitted for more than 20 seconds, dashes scroll across the display.

5. When you reach the time limit for the course, a cool-down period begins. The running belt slows and the incline returns to 0% incline.

Note: The speed remains constant if you were at or below 2 mph (3.2 kph).

During your cool down, the displays on the console continue to appear. The Time display counts up from zero so you know how long you have been in the cool-down period. Refer to *Cooling Down After Your Workout*.

6. To end a cool-down period, press Hold to Reset for a few seconds. The running belt stops and the Precor banner appears. The statistics displayed during your cool down are stored in the software's memory.
7. When the running belt comes to a complete stop, straddle the running belt, remove the safety clip from your clothing, and step off the treadmill if you have finished your workout.
8. Turn OFF the treadmill using the ON/OFF switch.
9. To prevent unauthorized use, remove the magnetic safety key from inside the electronic console and store it in a safe place.

Taking the Fitness Test

If you are wearing the Precor chest strap, you can take the Fitness Test to determine your cardiovascular fitness. The software stores your fitness score (with your user I.D.). The Fitness Test measures the maximum amount of oxygen the body can use for energy production during exercise. The higher the amount of oxygen that your body can use, the greater your ability to exercise for prolonged periods without tiring.

The Fitness Test determines heart rate response to varying levels of exercise. It's a simple procedure that reveals valuable information about your current fitness level. You can use the results of the Fitness Test to personalize a weight loss training program to meet your needs.

Important: Before taking the Fitness Test, sit and rest for five minutes prior to running or walking on the treadmill. This brings your heart rate to a resting state.

To use the Fitness Test follow the steps in *Working Out on the M9.45i Low Impact Treadmill* and choose program "FT" at the Program prompt. The following occurs:

- If you have taken the Fitness Test, your fitness score will appear in the bottom right display window when the Weight and Fitness Score indicator lights are lit. If the Fitness Test was the last program you used, you can press QUICK START to bypass the setup prompts. Be sure to hold onto the handrail because the running belt will automatically start to move.
 - The treadmill verifies that it detects a signal from the chest strap and requests that you state your gender. Use any ▼ or ▲ key to choose male or female and press ENTER. Your gender is used to determine your fitness category. See Tables 1 and 2.
1. A warning message scrolls across the display. To start the Fitness Test, keep your hand on the handrail and press ENTER. The running belt starts moving and the course profile appears on the display. Step onto the running belt by placing one foot onto the running belt followed by the other, while the speed is at or below 1 mph (1.6 kph). Begin walking. Once you are comfortable with the movement of the treadmill, you can remove your hand from the handrail.

Note: The fitness score is affected by your weight and age. Be sure you have entered a number that accurately depicts your weight and age or the fitness score might be inaccurate.

Let the test adjust the running belt's speed and incline for you. Avoid changing the speed or incline during the test. Changing the speed or incline using the ▼ or ▲ keys will invalidate the test. However, if you need to change the speed or incline to regain control or reduce your heart rate, please do so—you can retake the Fitness Test later.

CAUTION: The treadmill may automatically change incline when you enter a program. Stay clear of the lift mechanism and hood area until the treadmill has completed its recalibration.

Important: Six stages (3 minute intervals) comprise the Fitness Test. The number of stages you complete is dependent on your level of fitness. Do not be alarmed if you do not complete all six stages; this is normal. However, you must complete at least two stages to receive a fitness score. Stopping or pausing during the Fitness Test, invalidates the test and you do not receive a fitness score.

- When you successfully finish the test, the fitness score scrolls across the display. Then, the displays clear and your fitness score appears in the lower right display window. Your fitness category appears in the left display and is derived from your fitness score and gender. If you dispute the fitness score being displayed, you can retake the Fitness Test after a rest period.

Note: When you finish the Fitness Test, the running belt's speed slows to 2 mph (3.2 kph) and the treadmill's lift returns to 0% incline. Use the SPEED ▼ or ▲ keys to regulate the speed during your cool down.

- When the cool-down period ends, a prompt scrolls across the display explaining how to exit the program.

Table 1

Cardiovascular Fitness Score Category—Females

Age in Years	Low Fitness	Medium Fitness	High Fitness
20 - 39	28 (or below)	28 - 33	33 (or above)
40 - 49	26 (or below)	26 - 31	31 (or above)
50 - 59	24 (or below)	24 - 28	28 (or above)
60 and over	22 (or below)	22 - 26	26 (or above)

Table 2

Cardiovascular Fitness Score Category—Males

Age in Years	Low Fitness	Medium Fitness	High Fitness
20 - 39	35 (or below)	35 - 42	42 (or above)
40 - 49	32 (or below)	32 - 39	39 (or above)
50 - 59	29 (or below)	29 - 36	36 (or above)
60 and over	24 (or below)	24 - 31	31 (or above)

Values in Tables 1 and 2 are based on the findings of the Aerobics Center Longitudinal Study, an eight-year study involving over 13,000 female and male participants.

- Refer to Tables 1 and 2 to determine whether your fitness score places you in a Low, Medium, or High cardiovascular fitness category for your age and sex.
- Once you have finished your workout, press STOP to stop the running belt. To store the Time, Distance, and Calories statistics with your cumulative totals and return to the Precor banner, press Hold to Reset for a few seconds. If you are finished working out, straddle the running belt, remove the safety clip from your clothing, and carefully step off the treadmill.

Note: At the end of your workout, be sure to remove the chest strap, clean it, and store it in a safe place. Refer to *Storing the Chest Strap*.

- Turn OFF the treadmill using the ON/OFF switch.
- To prevent unauthorized use, remove the magnetic safety key from inside the electronic console and store it in a safe place.

Using the Weight Loss Program

The Weight Loss program uses the Smart Rate™ system and incorporates the results of the Cooper Institute's latest research on weight loss and control. It's designed to help you burn the most calories during a 28-minute workout, while minimizing the risk of discomfort and injury. Performed three or four times a week, the weight loss program can help you reach your ideal weight and fitness level quickly and efficiently.

When you wear the Precor Heart Rate Option's chest strap, the software uses your heart rate to adjust the incline setting which, essentially, customizes a Weight Loss program for you. To maximize its effectiveness, use the chest strap every time you workout.

CAUTION: The QUICK START key automatically starts the running belt after the message "Belt Starting 3, 2, 1,..." scrolls across the display. Hold onto the handrail before stepping onto the running belt.

Note: You must wear the Precor Heart Rate Option the first time you access the Weight Loss Program. If you do not, a message scrolls across the display reminding you to put on the chest strap. If you do not have the Precor Heart Rate Option, press ENTER or Hold to Reset to return to the user I.D. prompt.

To use the Weight Loss program, follow the steps found in the section titled *Working Out on the M9.45i Low Impact Treadmill*. When the electronic console display prompts you to enter a program, choose program number "13."

The Weight Loss program is similar to a 4-minute (rest/work) interval program. You *can* change the incline setting; however, the effectiveness of the weight loss program will vary.

If you use the Precor Heart Rate Option, the M9.45i software automatically adjusts the rest or work intervals if your heart rate is above or below the recommended zones for your age. You can see, by the blinking segment on the Smart Rate™ display, that the software tries to maintain your heart rate at the lower end (55% of maximum heart rate) while in the "rest" intervals and attempts to keep it at 70% of maximum heart rate while in the "work" intervals.

Important: You can workout without the chest strap transmitter if you have previously completed the Weight Loss program. The M9.45i software reinstates the rest and work intervals from memory. However, if you are not wearing the chest strap and *do* change the incline settings, the treadmill returns to the preset levels at the beginning of the next rest or work interval.

Correcting Inconsistent Heart Rate Readings

If your fitness score is inconsistent with previous tests, or the heart rate display becomes erratic, or no heart rate appears on the display, take the following steps:

1. Make sure that the electrodes on the chest strap are moist and placed properly against your skin. Sometimes, due to body chemistry, the chest strap cannot successfully detect and transmit your heart rate. If this occurs, use the electrolyte spray that accompanies your Precor Heart Rate Option package. Follow the directions on the bottle. After spraying the electrode strips on the chest strap, check to be sure that the strap is comfortably tight around your chest and centered in the middle of your chest. Refer to Diagram 15 in the section titled, *Wearing the Chest Strap Transmitter*.
2. Make sure that the treadmill is turned ON and the magnetic safety key is secure.
3. Be sure that you are within 3 feet of the electronic console and facing toward it. Allow a few seconds for the receiver to display your heart rate on the electronic console's display.

If you have taken the steps above and still get erratic readings, you may need to replace the chest strap transmitter or its battery. Refer to the section titled, *Changing the Battery in the Chest Strap*. To locate the Precor dealer nearest you, dial 1-800-4-PRECOR.

Troubleshooting Heart Rate Error Messages

While you are performing the cardiovascular courses, situations can arise that cause certain messages to scroll across the M9.45i display. These messages indicate that a problem has occurred and briefly explain what to do to correct the situation.

Several messages have a variety of solutions. These solutions, along with their error messages (in quotes), are presented below. You can remedy most situations by following the instructions beneath the message.

Note: The following messages (in quotes) scroll across the display once.

Message: "INCOMPLETE HEART RATE SIGNAL—"PLEASE CONSULT MANUAL FOR HELP"

Description: The M9.45i electronics are having difficulty acknowledging the signal from the heart rate receiver. The Fitness Test will not work without a heart rate signal so it is important to resolve this situation.

Solution: Follow the steps in the section above titled, *Correcting Inconsistent Heart Rate Readings*.

Message: "TEST INCOMPLETE—YOU MUST NOT STOP"

"PLEASE RETAKE TEST AT A LATER TIME"

Description: If the software senses that you paused during the Fitness Test, this message appears and you will not receive a fitness score for this particular session.

Solution: Do not stop or pause during the Fitness Test and keep a steady and smooth pace while taking the Fitness Test. The Fitness Test requires a continuous workout to produce an accurate fitness score. If you need to retake the test, you must rest awhile or the test will be invalid.

Message: "SORRY—TEST INVALID—MUST COMPLETE AT LEAST 2 STAGES"

Description: If your heart rate exceeds 85% of your maximum heart rate (maximum heart rate is defined as 220 minus your age), at the end of the 1st stage of the test, or your heart rate meets or exceeds 100% of your maximum heart rate during the first or second stage of the test, this message will appear.

Solution: If you have not been involved in an exercise program or regimen, your heart rate may exceed what the M9.45i software will safely accept. Check with your physician before beginning any type of workout program. Do not continue with any type of workout until you have consulted with your physician.

If you feel that you are in good shape and your physician confirms this fact, the receiver or transmitter may not be functioning correctly. Follow the steps in the section above titled, *Correcting Inconsistent Heart Rate Readings*.

Message: "SORRY—INCONSISTENT DATA" "PLEASE CONSULT MANUAL FOR HELP"

Description: The software senses that your heart rate during the last stage that you completed was equal to or less than the previous stage. This situation might occur if your heart rate signal is poor or incomplete, your workout is inconsistent or interrupted, or you place weight on the handrails during portions of the test.

Solution: To remedy a poor or incomplete heart rate signal, follow the steps in the section above titled, *Correcting Inconsistent Readings*. Do not stop or pause during the Fitness Test and keep a steady and smooth pace while taking the Fitness Test. Do not shift your weight or push down on the handrails. Try retaking the test after a prolonged rest period.

Message: "SORRY—INCONSISTENT DATA" "PLEASE RETAKE TEST AT A LATER TIME"

Description: The software calculated your fitness test score to be equal or greater than 80. This score is nearly impossible to attain under ideal circumstances. It indicates that your heart rate is extremely low for the amount of work accomplished or the difference between the last two stages of the test that you completed was equal to or less than the previous stage. This situation might occur if your heart rate signal is poor or incomplete, your workout is inconsistent or interrupted, or you place weight on the handrails during portions of the test.

Solution: To remedy a poor or incomplete heart rate signal, follow the steps in the section above titled, *Correcting Inconsistent Readings*. Do not stop or pause during the Fitness Test and keep a steady and smooth pace while taking the Fitness Test. Do not shift your weight or push down on the handrails. Try retaking the test after a prolonged rest period.

6

Getting the Most Out of Your Workout

To help you get started in planning and carrying out your fitness program, this section provides some basic information on aerobic exercise—such as how hard you should work out, how long each session should be, and how often you need to exercise to benefit from a regular program.

A workout on the M9.45i Low Impact Treadmill provides excellent and efficient cardiovascular conditioning, while strengthening and toning all the major muscle groups in the lower body. Darkened areas in Diagram 16 indicate the muscles improved.

Diagram 16

Muscles improved

1. Trapezius
2. Deltoid
3. Pectorals
4. Rhomboids
5. Triceps
6. Biceps
7. Latissimus Dorsi
8. Forearm Flexors/Extensors
9. Abdominals
10. Erector Spinae
11. Gluteals
12. Hip Flexors
13. Quadriceps
14. Hamstrings
15. Gastrocnemius/Soleus
16. Peroneus Longus/Brevis

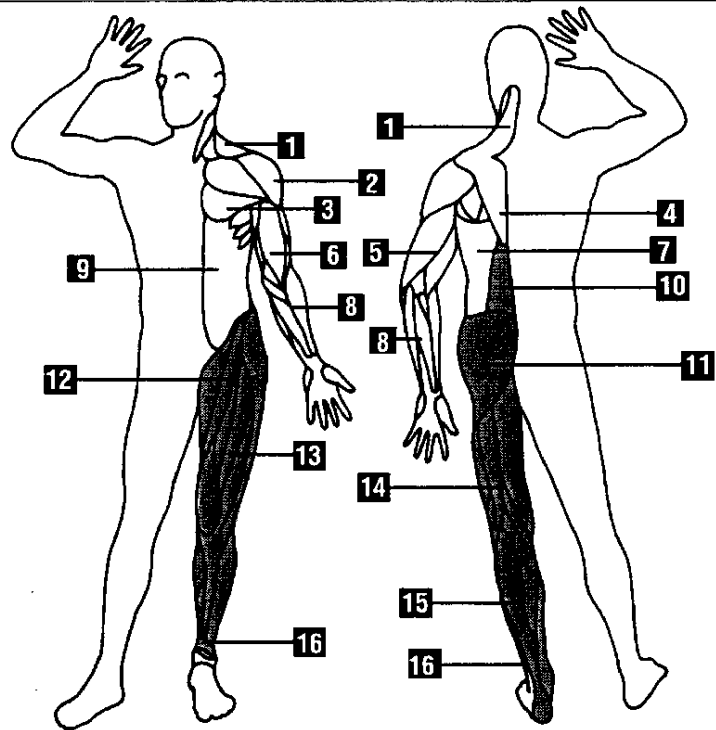

To get the most out of each workout, a general understanding of the principles behind aerobic training is invaluable. The best source of information is your specialty fitness dealer. In addition to providing information on which exercise equipment is best for your individual needs, your fitness dealer can provide useful advice on training, technique, and exercise physiology. Your dealer can also recommend good books and audio/video tapes on these subjects.

How Hard Should I Exercise?

Studies show that to achieve the benefits of aerobic exercise, it is necessary to work out hard enough to raise your heart rate to a certain minimum level, called the "training zone." Your training zone depends on your age and level of fitness.

Diagram 17

Training zones

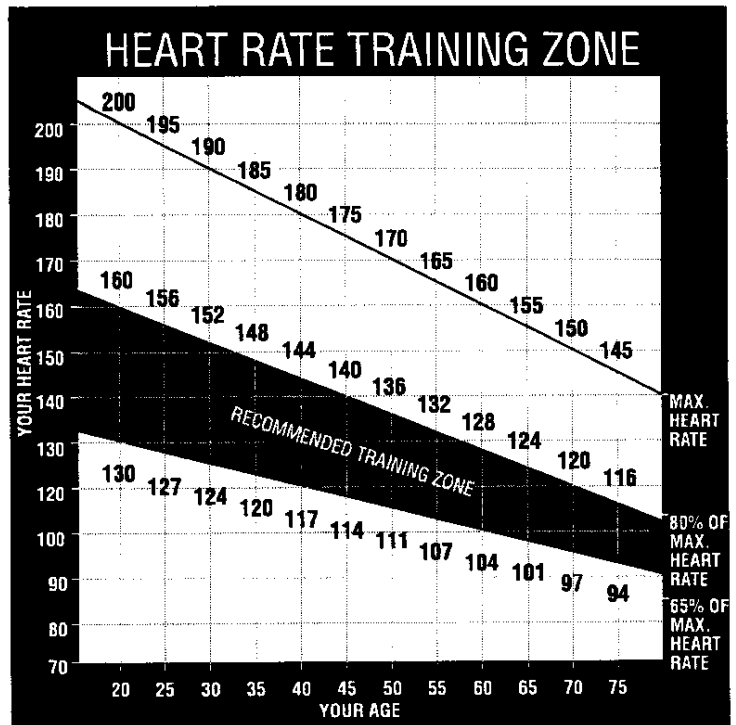

Diagram 17 shows your recommended heart rate training zone, which is calculated using your age and your maximum aerobic heart rate. Your maximum aerobic heart rate is equal to 220 minus your age. The chart is based on a resting heart rate of about 72 for males and 80 for females. Your optimum training zone is between 65% and 80% of your maximum heart rate. For efficient aerobic exercise, work only hard enough to keep your heart rate in this zone. You will obtain the greatest fat-burning benefits when you exercise within the optimum training zone.

Pushing yourself beyond the recommended range, (that is, exercising so hard that your heart rate rises above 80% of maximum) can overstress your muscles. To increase cardiovascular improvement, exercise *longer*, not harder.

Keep in mind that this zone is an approximation, to be used as a guideline—individual heart rates vary according to several physiological factors. To determine your training zone, find your age on the diagram, and then find the line where they intersect. For example, if you are 35 years old, your training zone is between 114 and 140 beats per minute. Remember this zone—this is the heart rate zone you should try to maintain as you work out.

If you do not have an accurate heart rate monitor, you can determine your heart rate by taking your pulse at a place that you can reach easily and comfortably while you exercise. Typical places for measuring heart rate are directly over the heart on the left side of the chest, on either side of the neck, over the temple, or on the thumb side of either wrist. Wherever you measure your pulse, make sure that you use your index and middle fingers—not your thumb. Your thumb has a strong pulse which can affect your pulse rate reading.

Once you locate your pulse, look at a clock with a second hand, and count the beats for six seconds. Multiply that number by 10 to determine the total number of beats per minute. For example, if you count 14 beats over six seconds, the total number of beats per minute is 140. Compare the total number of beats with your training zone as identified in Diagram 17. If necessary, increase or decrease your activity level to bring your heart rate into your training zone. You can regulate your work level (and heart rate) by changing belt speed and incline. **Remember—your heart rate is the definitive measure of how hard you are working.**

Regardless of your fitness level, avoid doing too much too soon. Running or walking too fast or choosing too high of an incline are common errors. Give yourself time to become familiar with your treadmill and to improve your fitness level. Then you can gradually increase speed and incline to make your workouts more challenging.

How Long Should I Exercise?

The length of each exercise session depends on your fitness level. Exercise physiologists have determined that, to attain cardiovascular benefits from exercise, you should maintain your heart rate in its training zone for at least 15 minutes. This is in addition to your warm-up time, and does not include cool down. You should always allow several minutes to bring your heart rate into the training zone, by starting out slowly and gradually increasing work level. Similarly, use several minutes of light exercise after the workout to bring your heart rate down to near resting level.

The higher your fitness level, the longer you should maintain your heart rate in the training zone (between 20 and 30 minutes). Beginners should always start slowly, and gradually bring their sessions up to 20 minutes or more.

How Often Should I Exercise?

Research indicates that aerobic sessions of 20 minutes or more should be done at least three to five times a week to obtain significant cardiovascular benefits. Most experts agree that sensible eating habits and regular aerobic exercise are the keys to weight control and fitness. A recent study, which tracked several subjects over a period of years, conclusively shows that exercise, not dieting, is the key factor to long-term weight loss.

7

Maintaining the M9.45i Low Impact Treadmill

The M9.45i Low Impact Treadmill requires little maintenance to keep it running smoothly and efficiently. However, the customer is responsible for the typical maintenance tasks such as, cleaning the treadmill and adjusting the running belt. If you fail to maintain the treadmill as described below, it could affect or void the limited warranty.

Cleaning the Equipment

CAUTION: Turn OFF the treadmill and disconnect the power cord before performing most maintenance tasks.

Your Precor treadmill relies on low friction for efficient operation. To keep the friction low, the treadmill must be as clean as possible.

Before a workout, use a damp, soft, clean cloth to clean the side platforms and running bed, (refer to Diagram 18 and its callouts). This removes any dirt or dust that might affect the smooth operation of the treadmill.

Vacuum the floor underneath the unit every week to prevent the accumulation of dust and dirt on the running belt.

CAUTION: Do not use an abrasive cleaner on the strap. Do not immerse any part of the chest strap. Do not spray or pour liquids on any part of the equipment.

To periodically clean the treadmill's frame, electronic console, and running belt use a solution of mild soap and water and dampen a clean cloth. To clean the running belt and the grooves on the plastic trim strip, use a soft nylon scrub brush. Never pour water or spray liquids on the electronic console. Allow the treadmill to dry completely before using it.

Manually advance the running belt to clean the opposite side. Do not clean the belt while the running belt is moving. Liquid can splash onto the motor causing damage to the equipment and possibly injuring you.

The Precor Heart Rate Option equipment requires little maintenance beyond keeping it dust free and cleaning the chest strap with mild soap and water. Use a damp sponge or soft cloth to clean the chest strap. Dry the surface thoroughly with a clean towel.

Storing the Chest Strap

Store the chest strap transmitter in a place where dust and dirt cannot accumulate on it such as, a closet or drawer. Be sure to keep the chest strap protected from extremes in temperature. Do not store it in an area that may be exposed to temperatures below 32 degrees Fahrenheit.

Diagram 18

*Alignment of the
running belt*

Running bed
Side platform

Rear roller

Belt adjustment bolt

Running belt

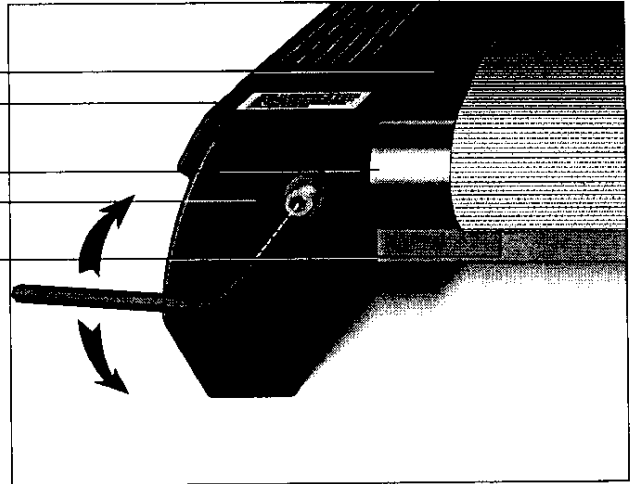

Aligning the Running Belt

Before aligning the running belt, check its operation by following the procedure in *Checking the Alignment of the Running Belt* on page 8. If you determine that the belt needs alignment, follow the instructions here.

Realigning the belt takes a few simple adjustments. If you are unsure about this procedure, call your authorized Precor dealer for service (see *Obtaining Service*).

Take the following steps to adjust the running belt on the M9.45i treadmill. To ensure your safety, make all adjustments while the treadmill is OFF.

1. Make sure the treadmill is OFF and the running belt has completely stopped.
2. Locate the left belt adjustment bolt at the rear of the treadmill as shown in Diagram 18. The direction you turn the bolt depends on how the belt is tracking. Make all belt adjustments on the left rear corner bolt using the hex key provided.
 - If the belt is off center to the LEFT, turn the adjusting bolt 1/4 turn clockwise, which moves the running belt to the right.
 - If the belt tracks off center to the RIGHT, turn the bolt 1/4 turn *counterclockwise*; this moves the belt to the left.

Important: Do not turn the adjusting bolt more than 1/4 turn at a time. *Overtightening the bolt can damage the treadmill.*

3. Insert the Safety key, turn ON the treadmill, press the QUICK START key, and then increase the running belt speed to 3 mph (5 kph) by pressing the SPEED ▲ key.
4. Observe the running belt for a couple of minutes. The belt should track centered on the running bed.
5. Press STOP to stop the running belt.
6. If the belt needs additional alignment, repeat steps 1 through 5 of this procedure until the belt is properly aligned.

CAUTION: Special care must be taken when aligning the running belt. Turn OFF the treadmill while adjusting or working near the rear roller. Remove any loose clothing and tie back your hair. Be very careful to keep your fingers or any other object clear of the belt and rollers, especially in front of the roller and behind the deck. The treadmill will not stop immediately if an object becomes caught in the belt or rollers.

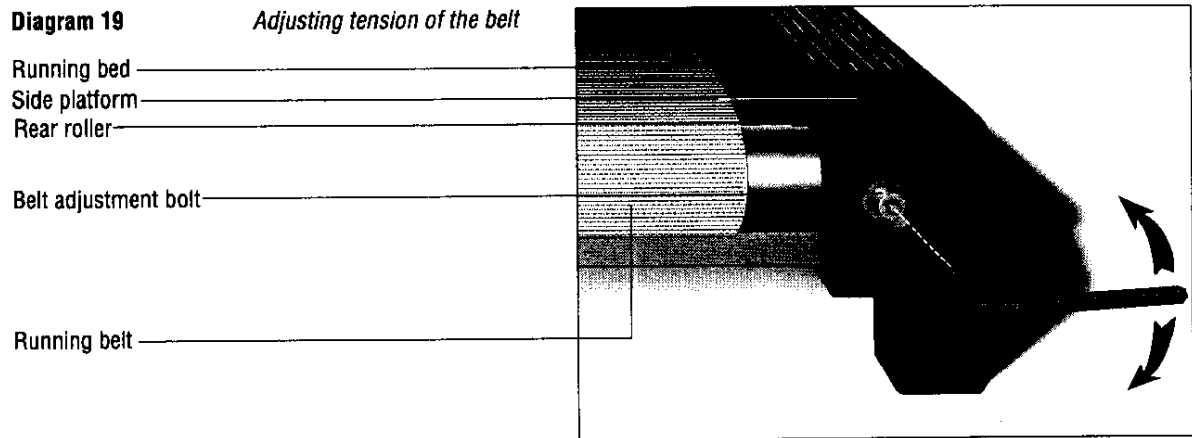

Adjusting the Tension of the Belt

CAUTION: Stand to the side of the treadmill. The running belt begins moving automatically after you press QUICK START.

CAUTION: If you hear a chafing sound or the belt begins to tear or fray, stop the running belt immediately by pressing the STOP key or pulling the magnetic safety key out of the electronic console. Contact your Precor service representative.

Proper belt tension is important for a smooth, steady run. If your physical condition permits, test the belt tension by jogging at 6 mph. If the belt tension is too loose, you will feel a pause in the belt with each footplant (step).

To adjust the running belt tension, take the following steps:

1. Make sure that the treadmill is OFF. If the treadmill is ON, switch it to OFF. Wait for the running belt to come to a complete stop.
2. Standing behind the treadmill use the rear belt adjustment bolts (refer to Diagram 18 on the previous page and Diagram 19). Simply turn each bolt *clockwise* 1/4 turn to adjust the tension of the belt.
3. Turn ON the treadmill, answer the start-up prompts, then increase the speed of the running belt to 6 miles per hour by pressing the SPEED ▲ key.
4. Jog on the running belt for 1 minute or more. If you feel a pause in the belt with each footplant (step), you need to continue to adjust the belt tension.
5. Press STOP to stop the running belt.
6. Continue with steps 1 through 5 until the belt tension has been properly adjusted and you no longer feel the pause in the belt with each footplant.

Important: Do not turn the adjusting bolts more than 1/4 turn at a time. Overtightening the bolts can damage or cause premature failure of the precision bearings in the front and rear rollers.

Servicing the Treadmill

Do not attempt to service the M9.45i yourself except for the maintenance tasks described in this manual. The M9.45i does not contain any user-serviceable parts, or parts that require lubrication. For information about product operation or service, contact an authorized Precor dealer at 1-800-4-PRECOR.

Power Cord Maintenance

When the M9.45i is in use, ensure that the power supply cord is away from moving parts and cannot be damaged.

If the M9.45i power supply cord is damaged, it must be replaced by the Precor part number 36956-102 which is a specific power supply cord assembly kit. It can only be replaced in an authorized Precor repair shop because special tools are required.

M9.45i Long Term Storage

When the M9.45i is not in use, ensure that the power supply cord is unplugged from the wall outlet and is positioned so that it will not become damaged or interfere with other equipment or people.

There are no special storage requirements for the M9.45i other than ensuring that it is kept free from dirt, moisture, or damage.

Displaying the Odometer and Software Version

To display the total number of miles or kilometers that the treadmill has accumulated, the software version number, and the error messages stored in memory, take the following steps:

1. In rapid succession, press STOP, SPEED ▲ and then SPEED ▼. (The numbers 6, 5 appear on the display as you press the respective key.)

Note: You need to press SPEED ▲ within 1 second after pressing STOP or the Precor banner returns and you need to start step 1 over again.

2. The cumulative odometer totals appear on the display. Cycle through all four user I.D.'s by pressing any ▼ or ▲ key. Then the combined cumulative total appears for the User I.D.'s.
3. Press a ▼ or ▲ key again and the combined odometer total for the treadmill appears. (This includes Manual courses accessed through QUICK START that are not associated with any User I.D., so the total can be more than the User I.D. sum.)
4. To view the software version, press ENTER. The software part number appears in the two upper right displays with the version number appearing in the lower right display. These numbers are useful if you need to call customer service.
5. To review the past ten error messages stored in the unit, press ENTER again. To clear error messages, simultaneously press and hold STOP and QUICK START for a few seconds when an error message is displayed.
6. Press ENTER to return to the Precor banner.

Obtaining Service

Do not attempt to service the M9.45i Low Impact Treadmill yourself except for minor belt adjustments and maintenance as described in this manual. The M9.45i treadmill does not contain any user-serviceable parts.

For information about product operation or service, contact an authorized Precor dealer or a Precor Factory Authorized Service Company. To locate the dealer or service person nearest you, call 1-800-4-PRECOR.

To help the customer service representative expedite your call, have your serial number available.

The serial number on the M9.45i treadmill is printed on a label located underneath the treadmill at the left, rear corner of the running bed frame. If you haven't already written the serial number in the space provided below during the assembly process, you will need to get on your knees and bend down to see it.

Model number: M9.45i Serial number: _____

If you have any questions regarding the treadmill, use the model and serial numbers whenever you call your Precor dealer or service person.

PRECOR USA

9.45i Low Impact Treadmill

Owner's Manual Addendum

This addendum accompanies your *M9.45i Owner's Manual*. It explains recent changes to the product that are not documented in the Owner's Manual (P/N 38035-101).

Displaying the Odometer and Software Version

The following text and key sequence replaces step 1 found on page 37 in the *M9.45i Owner's Manual*.

To display the odometer, software version number, and the error messages stored in memory, start at the Precor banner and press the following keys in sequence:

STOP, SPEED ▼, and QUICK START

Note: You need to press SPEED ▼ within 1 second after pressing STOP or the Precor banner returns and you need to begin again.

Continue with steps 2 through 6 on page 37 to view the software version number and the error messages stored in memory.

M9.45i Low Impact Treadmill featuring Smart Rate with the Cardiologic System

Specifications

Length:	76 inches (193 cm)
Width:	Handrails 31.5 inches (80 cm) Base 28.5 inches (72 cm)
Height:	50 inches (127 cm)
Running surface:	53 inches by 18 inches (135 cm by 46 cm)
Motor:	2 hp continuous duty
Speed:	0.5 to 10 mph (0.8 to 16 kph) 10 mph is equivalent to a 6 minute mile
Incline:	-2% to 12% grade
Power:	50/60Hz 120v AC (dedicated circuit) 50/60Hz 240v AC (dedicated circuit)
Weight:	265 lbs (119 kg)
Shipping weight:	326 lbs (147 kg)

Electronic Specifications

4 user identifications in memory/cumulative statistics are saved with each user I.D.

QUICK START

Programs:

Manual
2 Interval
(1 minute rest: 1 minute work)
(1 minute rest: 2 minute work)
Random
5 Preprogrammed courses
2 Custom courses
Weight Loss
Fitness Test
Heart Rate

Display Readouts:

Time
Distance (miles or kilometers)
Speed (mph or kph)
Incline

Calories
Heart rate
Fitness score
Smart rate

PRECOR[®] USA

Precor Incorporated
P.O. Box 3004
Bothell, WA USA 98041-3004

Precor and "M" are registered trademarks and "Cardiologic" and "Smart Rate" are trademarks of Precor Incorporated.
© 1997 Precor Incorporated.

Protected by one or more of the following U.S. and Foreign Patents:
US D303,414; US D313,826; US 5,336,144 and other pending applications.
Specifications subject to change without notice.
1-800-4-PRECOR

P/N 38035-101
11/97

NOTICE:

Precor is widely recognized for its innovative, award winning designs of exercise equipment. Precor aggressively seeks U.S. and foreign patents for both the mechanical construction and the visual aspects of its product design. Any party contemplating the use of Precor's product designs is hereby forewarned that Precor considers the unauthorized appropriation of its proprietary rights to be a very serious matter. Precor will vigorously pursue all unauthorized appropriation of its proprietary rights.

Free Manuals Download Website

<http://myh66.com>

<http://usermanuals.us>

<http://www.somanuals.com>

<http://www.4manuals.cc>

<http://www.manual-lib.com>

<http://www.404manual.com>

<http://www.luxmanual.com>

<http://aubethermostatmanual.com>

Golf course search by state

<http://golfingnear.com>

Email search by domain

<http://emailbydomain.com>

Auto manuals search

<http://auto.somanuals.com>

TV manuals search

<http://tv.somanuals.com>