

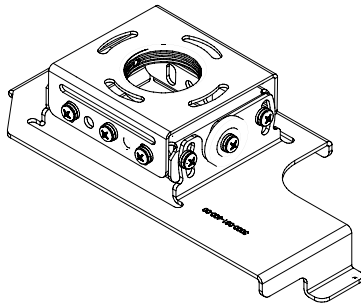

PDS-023 Projector Bracket Installation Instructions



PDS-023 Bracket (Qty 1)	M4 x 10mm Phillips Head Screws (Qty 3)	
	M4 x 10mm Security Head Screws (Qty 3)	

Premier Mounts
 3130 E. Miraloma Ave.
 Anaheim, CA 92806
 Phone: (800) 368-9700 Fax: (800) 832-4888
 techsupport@mounts.com www.mounts.com

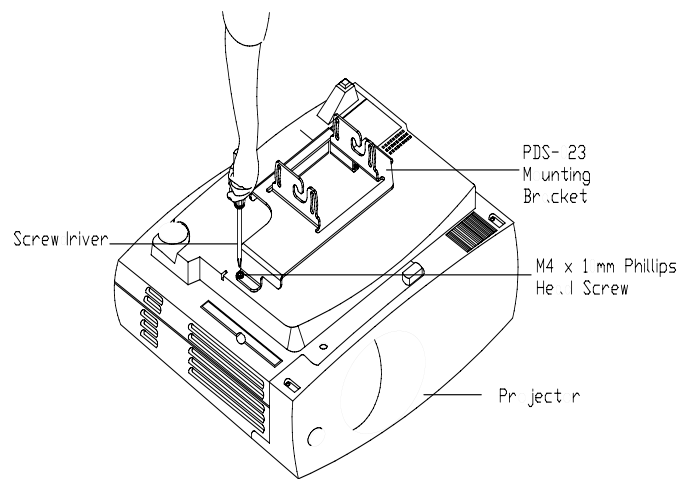
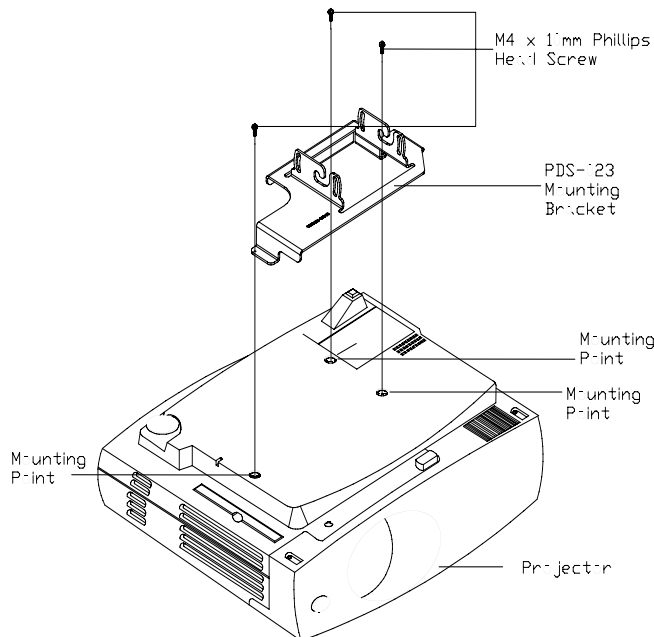

1. Invert the projector and place it on a soft and flat surface. Remove any foot levelers that might possibly prevent the correct installation of the bracket.
2. Locate the three mounting points located on the bottom of the projector.
3. Line up the mounting points on the projector with the mounting holes on the PDS-023 mounting bracket.

1. Using a screwdriver, secure the PDS-023 mounting bracket using three (3) M4 x 10mm Phillips Head screws. Do not over tighten these screws. Overtightening the screws may result in damaging the threaded inserts on the projector.

NOTE: Please refer to the PDS Base Box Installation Instructions to attach the PDS Base Box to the PDS-023 mounting bracket.

NOTE: The projector (shown above) is for illustration purposes only.



**LOCK-IT™
Security System**

Premier Mounts
3130 E. Miraloma Ave.
Anaheim, CA 92806
Phone: (800) 368-9700 Fax: (800) 832-4888
techsupport@mounts.com www.mounts.com

NOTE: To utilize the LOCK-IT™ Security System, all M6 x 12mm Phillips Pan Head screws (A) must be removed prior to installing the M6 x 12mm Security Screws (D).

1. Remove all pre-installed M6 x 12mm Phillips Pan Head screws (A - 6 total).
2. Use the M5 Security Wrench (B - supplied) to install and tighten the M6 x 12mm Security Screws (D).
3. Using the security wrench (supplied), remove the M6 x 8mm standard set screw and replace it with the M6 x 8mm security set screw (C).
4. Insert the nylon washer (G), 1/4" flat washer (H) and the M6 x 12mm Security Screw (D) into the pivot point (I).
5. Attach bracket to projector using security screws.
6. Once the Phillips Pan Head screws have been replaced with the security screws, re-attach the bracket (E) to the mount (F).
7. Insert the four tilt adjustment security screws (two per side).
8. Follow the instructions in the PDS Manual to complete the installation.

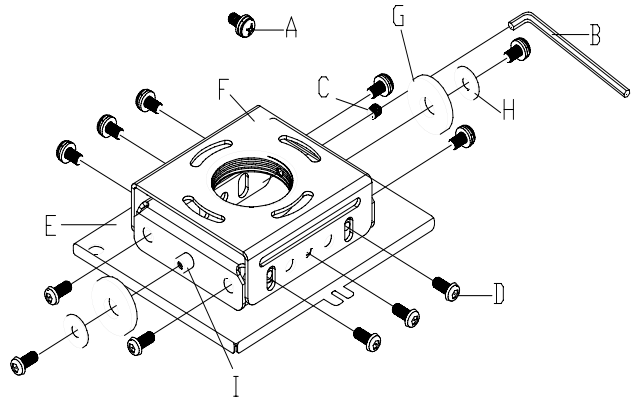

Mounting Bracket Security Screws

1. Using a security wrench (supplied), secure the PDS-023 mounting bracket using three (3) M4 x 10mm Security Head screws. Do not over tighten these screws. Overtightening the screws may result in damaging the threaded inserts on the projector.

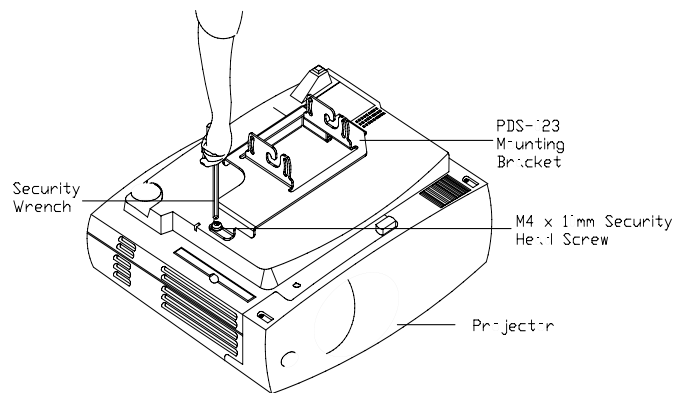

Free Manuals Download Website

<http://myh66.com>

<http://usermanuals.us>

<http://www.somanuals.com>

<http://www.4manuals.cc>

<http://www.manual-lib.com>

<http://www.404manual.com>

<http://www.luxmanual.com>

<http://aubethermostatmanual.com>

Golf course search by state

<http://golfingnear.com>

Email search by domain

<http://emailbydomain.com>

Auto manuals search

<http://auto.somanuals.com>

TV manuals search

<http://tv.somanuals.com>