

INSTALLATION INSTRUCTIONS

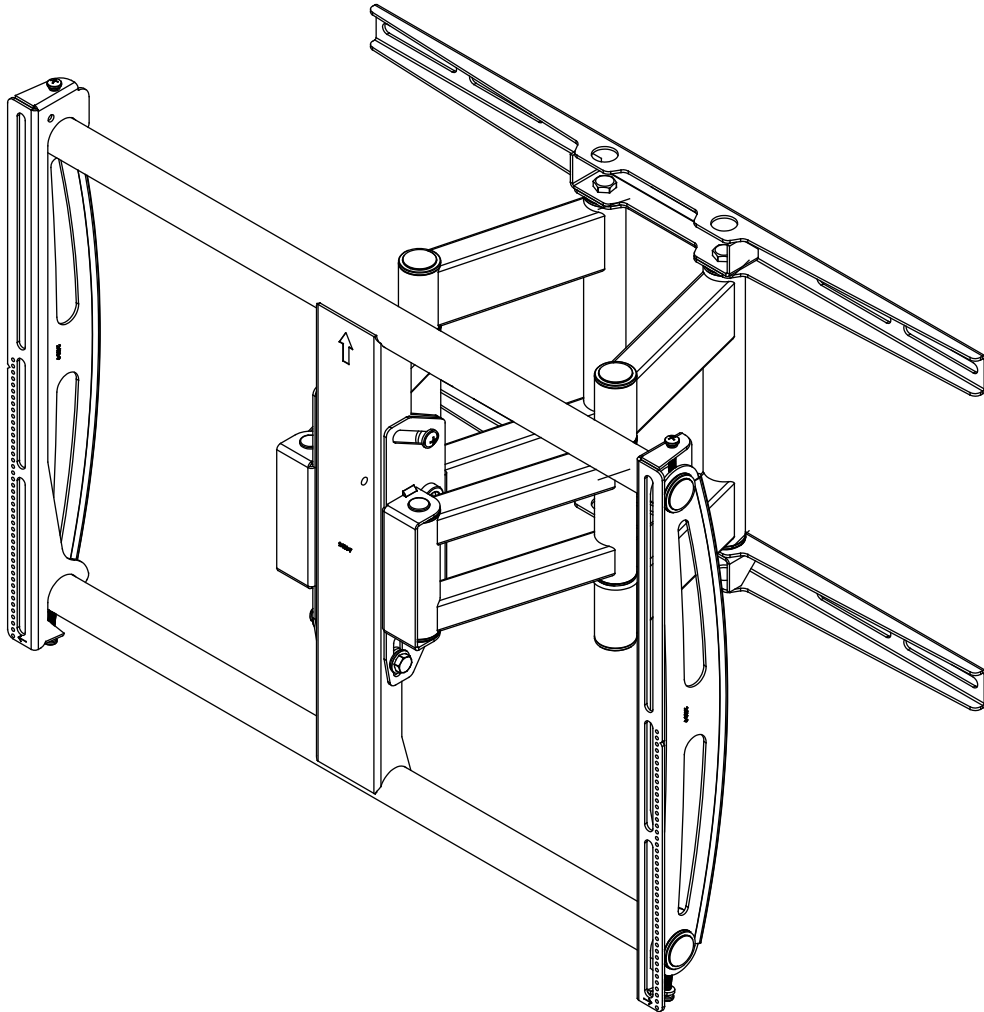

AM250/AM250-FLIP Universal Swingout Arm

NORTH AMERICA

3130 East Miraloma Avenue
Anaheim, CA 92806 USA
USA and Canada -
Phone: 800-368-9700
Fax: 800-832-4888

EUROPE

Swallow House,
Shilton Industrial Estate,
Shilton, Coventry, England CV79JY
Phone: +44 (0) 2476 614700
Fax: +44 (0) 2476 614710

AUSTRALIA, NEW ZEALAND, OCEANIA (Distributor)

P.O. Box 295
Mordialloc Victoria 3195
Australia
Phone: 03 9586 6330
www.premiermounts.com.au

Other Locations - Phone: (001)-714-632-7100; Fax: (001)-714-632-1044

©Premier Mounts 2008
9531-008-001-05



Table of Contents

Warning Statements.....	2
Parts List.....	3
Installation Tools.....	3
Thread Depth Indicator	6
Mount Installation.....	7
Concrete Mounting	8
Universal Mounting Bracket Assembly.....	8
Attaching the Display.....	9
Securing and Leveling the Display.....	10
Tilt Positioning.....	10
Technical Specifications.....	11
Warranty.....	12

Warning Statements



PRIOR TO THE INSTALLATION OF THIS PRODUCT, THE INSTALLATION INSTRUCTIONS SHOULD BE READ AND COMPLETELY UNDERSTOOD. THE INSTALLATION INSTRUCTIONS MUST BE READ TO PREVENT PERSONAL INJURY AND PROPERTY DAMAGE. KEEP THESE INSTALLATION INSTRUCTIONS IN AN EASILY ACCESSIBLE LOCATION FOR FUTURE REFERENCE.



PREMIER MOUNTS DOES NOT WARRANT AGAINST DAMAGE CAUSED BY THE USE OF ANY PREMIER MOUNTS PRODUCT FOR PURPOSES OTHER THAN THOSE FOR WHICH IT WAS DESIGNED OR DAMAGE CAUSED BY UNAUTHORIZED ATTACHMENTS OR MODIFICATIONS, AND IS NOT RESPONSIBLE FOR ANY DAMAGES, CLAIMS, DEMANDS, SUITS, ACTIONS OR CAUSES OF ACTION OF WHATEVER KIND RESULTING FROM, ARISING OUT OF OR IN ANY MANNER RELATING TO ANY SUCH USE, ATTACHMENTS OR MODIFICATIONS.



THE SURFACE MUST BE CAPABLE OF SUPPORTING AT LEAST FIVE TIMES THE WEIGHT OF THE DISPLAY. IF NOT, THE MOUNTING STRUCTURE MUST BE REINFORCED. PROPER INSTALLATION PROCEDURE BY A QUALIFIED SERVICE TECHNICIAN INSTALLATION , AS OUTLINED IN THE INSTRUCTIONS, MUST BE ADHERED TO. FAILURE TO DO SO COULD RESULT IN SERIOUS PERSONAL INJURY, OR EVEN DEATH.



SAFETY MEASURES MUST BE PRACTICED AT ALL TIMES DURING THE ASSEMBLY OF THIS PRODUCT. USE PROPER SAFETY GEAR AND TOOLS FOR THE ASSEMBLY PROCEDURE TO PREVENT PERSONAL INJURY.



At least two qualified people should perform the assembly procedure. Injury and/or damage can result from dropping or mishandling the display.



If mounting to studs, make sure that the mounting screws are anchored into the center of the studs. Use of an edge-to-edge stud finder is recommended.



Be aware of the mounting environment. If drilling and/or cutting into the mounting surface, always make sure that there are no electrical wires in wall. Cutting/drilling into an electrical line may cause serious injury.



Make sure there are no water lines inside the wall where the mount is to be located. Cutting/drilling into a water line may cause severe water damage to the mounting surface.



This product is intended for indoor use only. Use of this product outdoors could lead to product failure and personal injury.



Do not install near sources of high heat. Do not install on a structure that is prone to vibration, movement or chance of impact



Contact Premier Mounts with any questions
(800) 368-9700
techsupport@mounts.com



Parts List



NOTE

This mount is shipped with all installation hardware and components. Make sure that none of these parts are missing and/ or damaged before beginning installation. If there are parts missing and/or damaged, please stop and contact Premier Mounts (800) 368-9700.

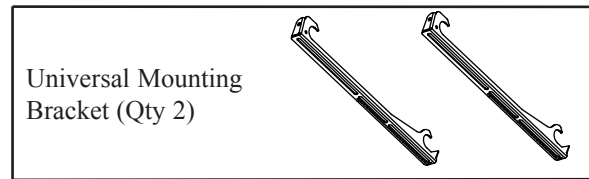
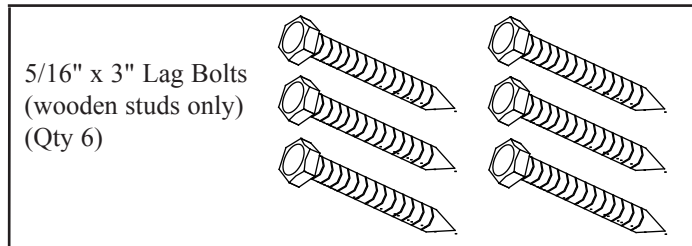
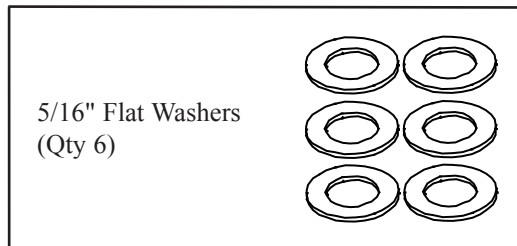
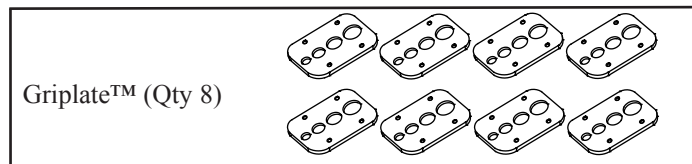
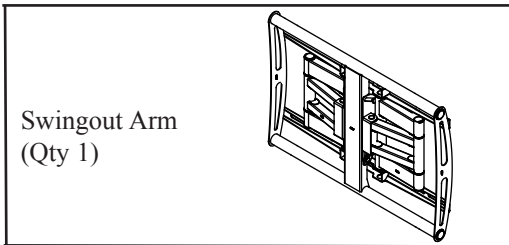

Installation Tools

- | | | |
|--|-----------------------------------|------------------------|
| Phillips Head Screw Driver | Soft Material/ Blanket | 1/2" Socket and Wrench |
| Pencil | Tape Measure | Drill Gun |
| Level (Supplied) | Thread Depth Indicator (Supplied) | |
| 1/4" Drill Bit (Pilot Holes) | | |
| Masonry Drill Bit (Concrete Applications - Commercially Available) | | |

**Parts List (Cont.)**

M4 x 16  (Qty 8)

M6 x 20  (Qty 6)

M4 x 25  (Qty 4)

M6 x 30  (Qty 6)

M5 x 12  (Qty 8)

M8 x 20  (Qty 6)

M5 x 16  (Qty 6)

M5 x 20  (Qty 6)

M8 x 25  (Qty 6)

M5 x 25  (Qty 4)

M8 x 30  (Qty 6)

M5 x 50  (Qty 4)

M8 x 35  (Qty 4)

M6 x 12  (Qty 8)

M8 x 70  (Qty 4)



Parts List (Cont.)

Nylon spacers and flat washers' actual size.



NOTE The nylon spacers may be stacked to achieve proper spacing.

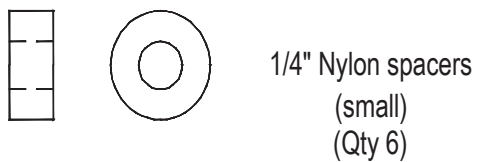
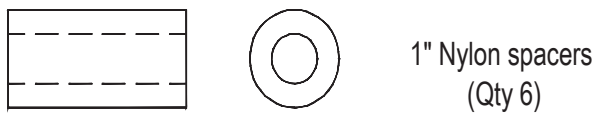
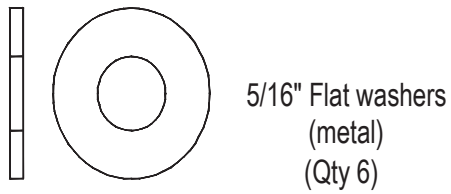
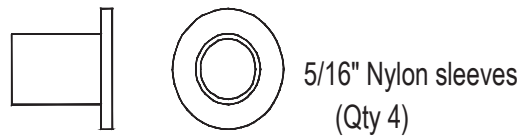
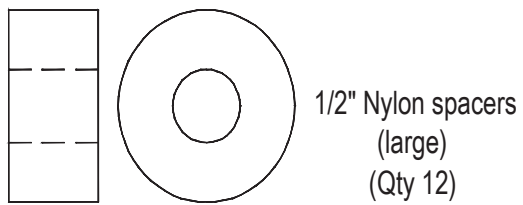
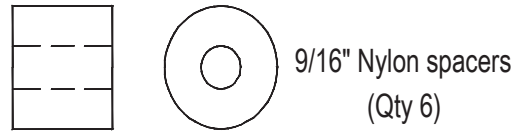
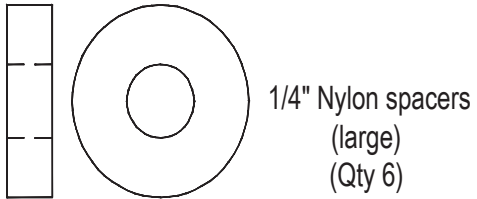



Thread Depth Indicator

- Step 1.** Insert the thread depth indicator (supplied) through the thread inserts found on the back of the flat panel to make sure the inserts measure the same full depth and mark it (Figure 1).
- Step 2.** Locate the correct diameter screw for the thread insert. Compare your marking to the screws (supplied).
- Step 3.** If your selected screw is longer than the marking on the thread depth indicator, DO NOT USE this screw.
- Step 4.** The screw length must not bypass the marking. Select another screw size (Figure 2 and 3), until you find one that comes closest to your mark without going past.

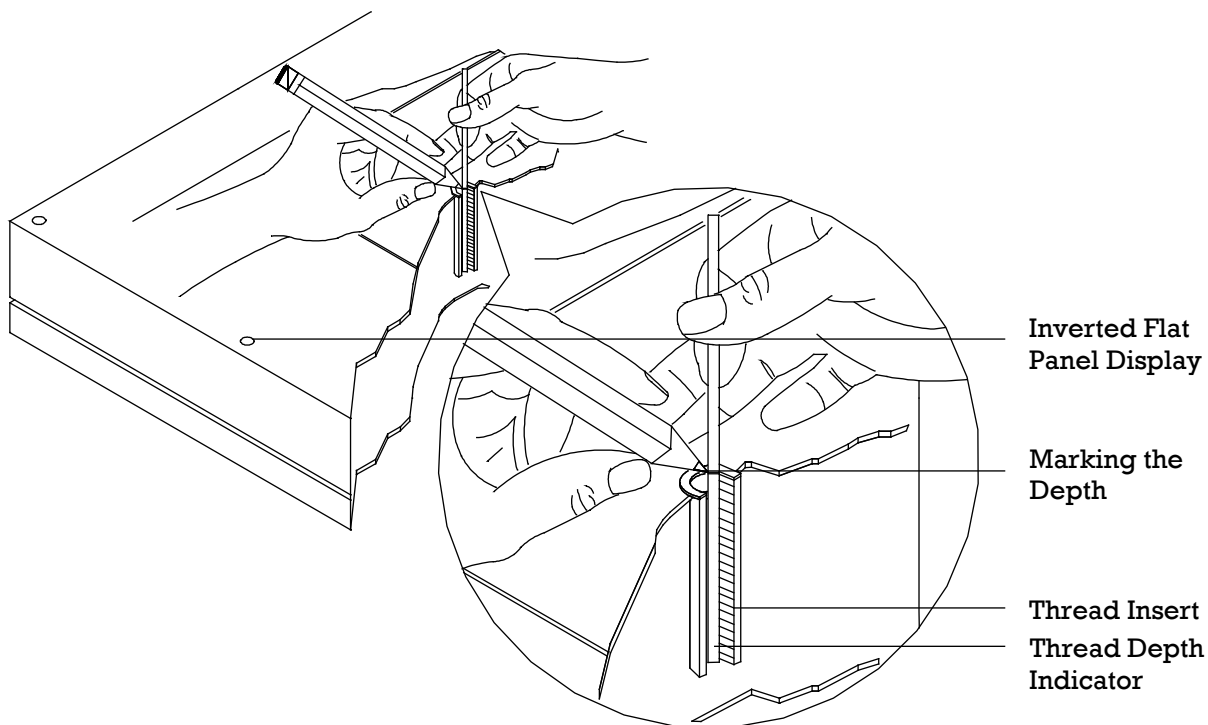

Figure 1

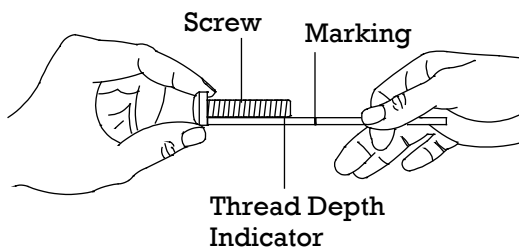

Figure 2

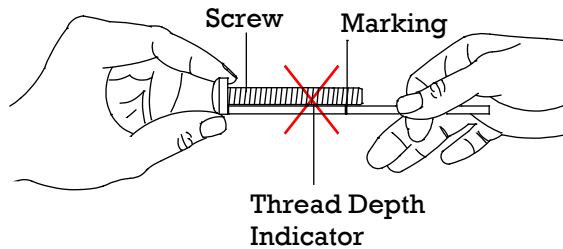

Figure 3



Mount Installation



WARNING

THE FOLLOWING STEPS SHOULD BE PERFORMED BY TWO PEOPLE.



NOTE

For ease of installation, it is recommended that two people perform the installation. One person should hold the mount while the other person installs the lag bolt and washer. Making sure that the mount is level, the person not holding the mount must mark and drill the second mounting hole and secure the second lag bolt and washer.



NOTE

If the studs are 12" apart, use three 3" lag bolts for the top row of mounting points and three 3" lag bolts for the lower row mounting points. If the studs are 16", 18" or 24" apart, use two 3" lag bolts for the top row of mounting points and two 3" lag bolts for the lower row of mounting points.



Step 1

Determine where to mount the AM250/AM250-FLIP. Use a stud finder to find the exact center of each stud.



Step 2

Once all of the studs have been located, use a pencil to mark the spots. Place the mount against the wall and align the mount to the marked stud locations.



Step 3

Using a 1/4" drill bit, drill a pilot hole at the first aligned and marked location.



Step 4

After the pilot hole has been drilled, line up the mounting slot opening to the drilled hole.



Step 5

Insert one (1) 5/16" x 3" lag bolt and washer into the mounting hole and tighten (see WARNING: below).



Step 6

With the help of an assistant, place a level on the center of the mounting rail and level the mount. Mark and drill the second mounting hole.

Insert one (1) 5/16" x 3" lag bolt and washer into the mounting hole and tighten (see WARNING: below). Repeat steps 5 and 6 for the remaining mounting points.



WARNING

Do NOT over-tighten lag bolts when attaching the mount to the wall. Improper installation may result in personal injury or damage to property.



NOTE

If the studs are 12" (304.8mm) apart, use three 3" (76.2mm) lag bolts for the top rail and three 3" (76.2mm) lag bolts for the lower rail. If the studs are 16" (406.4mm), 18" (457.2mm) or 24" (609.6mm) apart, use two 3" lag bolts for the top rail and two 3" lag bolts for the lower rail.



Concrete Mounting

NOTE Concrete anchors must be used for concrete installation. They can be purchased at your local hardware store. The mounting surface must be a minimum 6" thick.

- Step 1.** Begin by placing the mount into position against the wall, keeping it level.
- Step 2.** Mark off four holes to be used for securing the mount.
- Step 3.** Next, drill holes using a masonry bit for your anchors (recommended 5/16" masonry bit).
- Step 4.** Insert a commercially available concrete anchor into each hole (recommended 3/8" wedge anchors).
- Step 5.** If necessary, a hammer can be used to lightly tap each anchor into place so that they are flush with the wall.
- Step 6.** Once all of the anchors are in place, move the wall bracket into position.
- Step 7.** Attach the nut onto the threaded shaft that is protruding from the wall.
- Step 8.** Do not tighten until all nuts are in place.

Universal Mounting Bracket Assembly

- Step 1.** Place the display on a soft, flat surface, face-down.
- Step 2.** Determine where the mounting points are located.
- Step 3.** Place the universal brackets over the mounting points.

NOTE If the mounting surface is not completely level, use the spacers (see Page 6) to ensure that the universal brackets are level on the display.

- Step 4.** Once the desired position has been determined, place the Griplate™ over each mounting point (dimples facing up) and secure them using the appropriate hardware (see Page 5).

NOTE For the two upper mounting points, the dimples (Griplate™) must be facing up. For the two lower mounting points, the dimples (Griplate™) must be facing down.

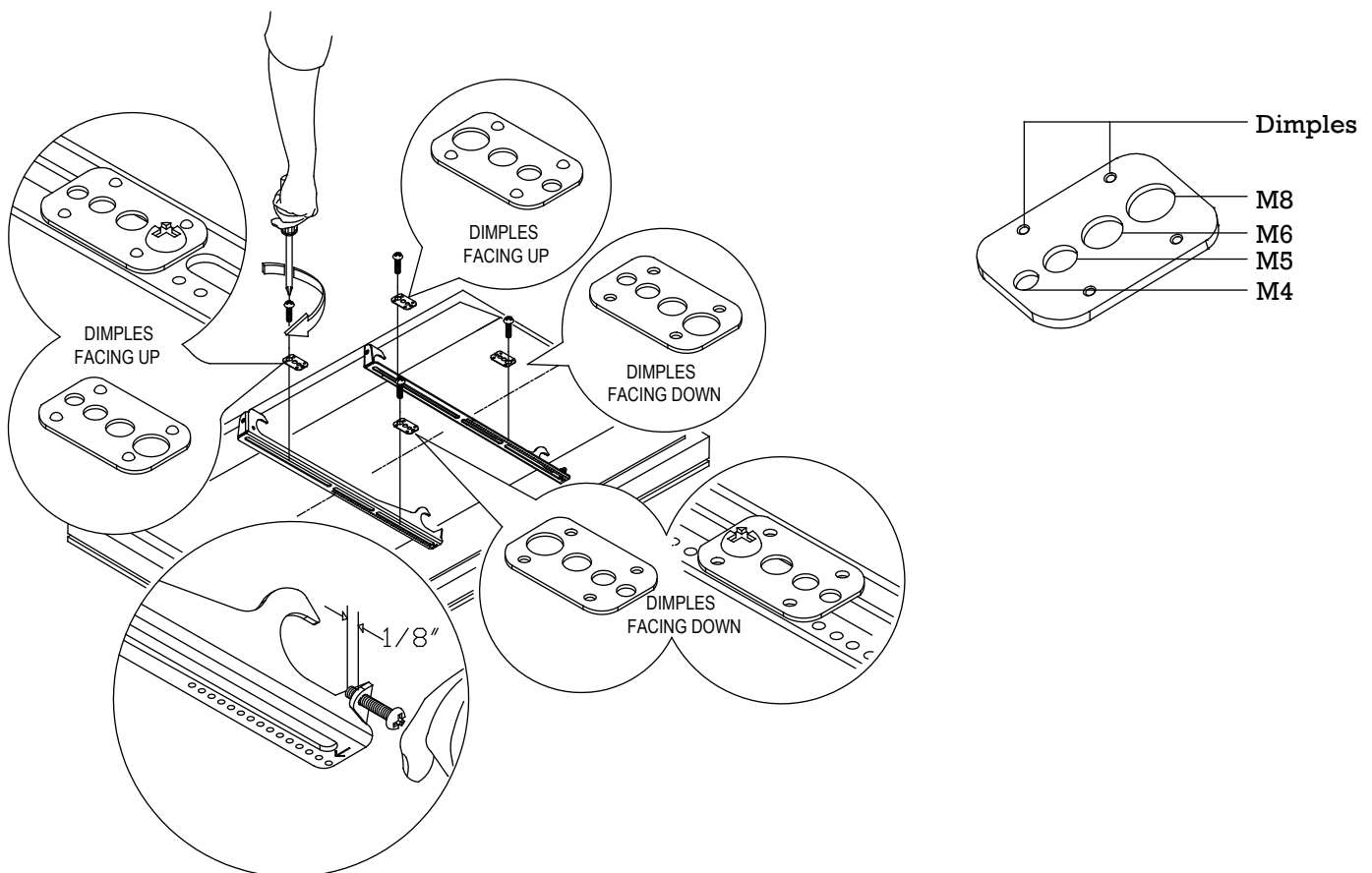



Attaching the Display



WARNING

IT IS RECOMMENDED THAT TWO PEOPLE MOUNT THE DISPLAY, AS THE UNIT IS HEAVY AND, IF DROPPED, WILL DAMAGE THE MOUNT, THE DISPLAY, AND/OR PERSONNEL.

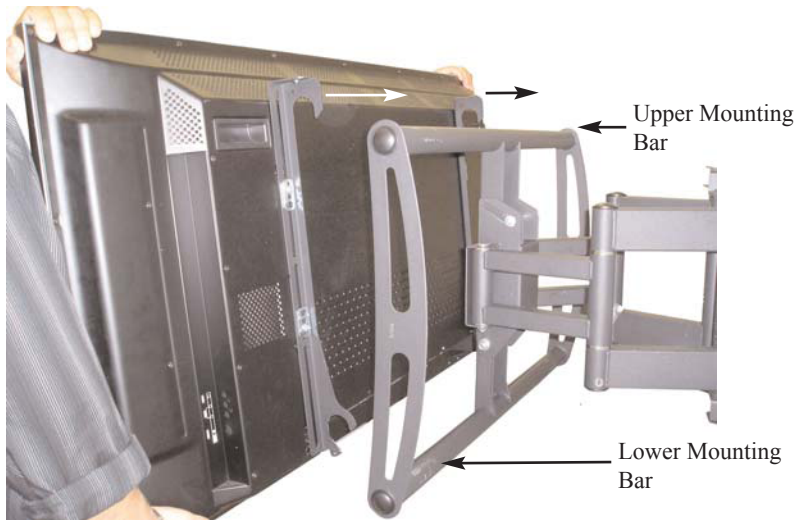

Step 1. Place the universal brackets and the display over the upper mounting bars of the AM250.

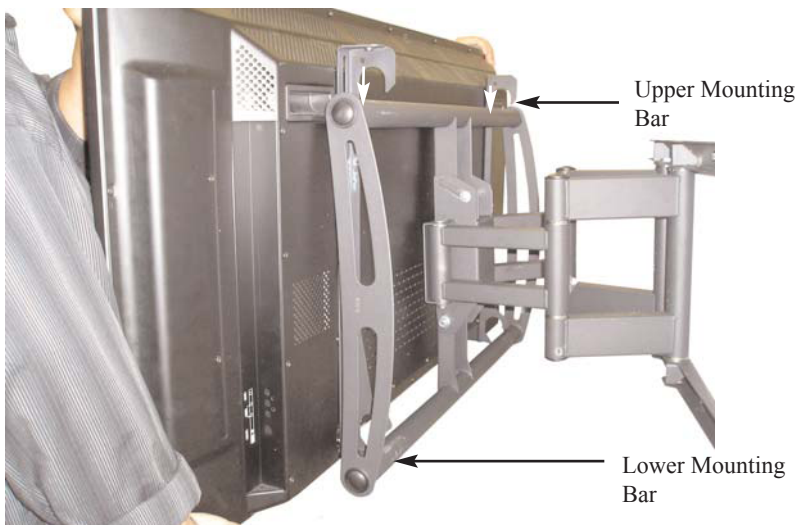

Step 2. Lower the universal mounting brackets and display onto the mounting bars of the AM250.



Step 3. This is what the two units will look like after the universal mounting brackets and display are mounted to the AM250.



Securing and Leveling the Display

Once the brackets have been placed over the upper mounting bars on the AM250, use two (2) M6 x 30mm Phillips Head locking screws to secure the brackets to the bottom of the mounting bars. This will prevent lateral shift movement. Level your flat panel by installing the two additional M6 x 30mm Phillips Head screws to the upper bracket assembly as shown below. Once the display is level, tighten the locking screws.

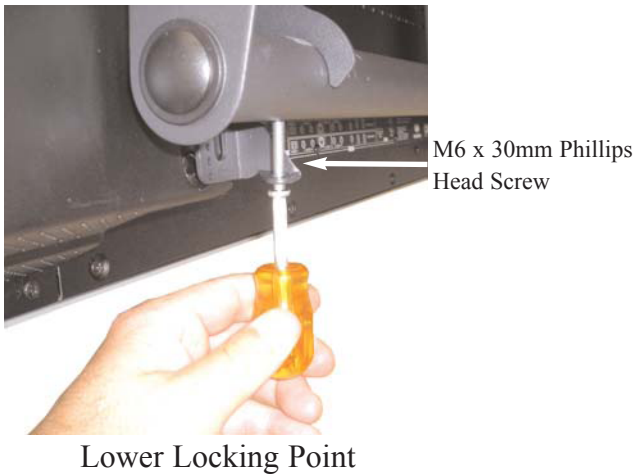

M6 x 30mm Phillips Head Screw



Tilt Positioning

 **NOTE** TO ADJUST THE TILT TENSION OF THE AM250, LOOSEN THE TENSION BOLTS LOCATED ON THE BOTTOM RIGHT AND LEFT SIDE OF THE MAIN ARM ASSEMBLY. RE-TIGHTEN THESE BOLTS TO ACHIEVE YOUR DESIRED TENSION.

To adjust the tilt of the display, place a hand in the top middle of the display and the other hand at the bottom middle of the display.

To Tilt the Display Forward

Gently pull on the upper portion of the display while pushing the lower end of the display away from you. This motion will cause the display to tilt forward.

To Tilt the Display Back

Gently push on the upper portion of the display and pull the lower end of the display towards you. This motion will cause the display to tilt back.





Technical Specifications

All measurements are in inches (mm).

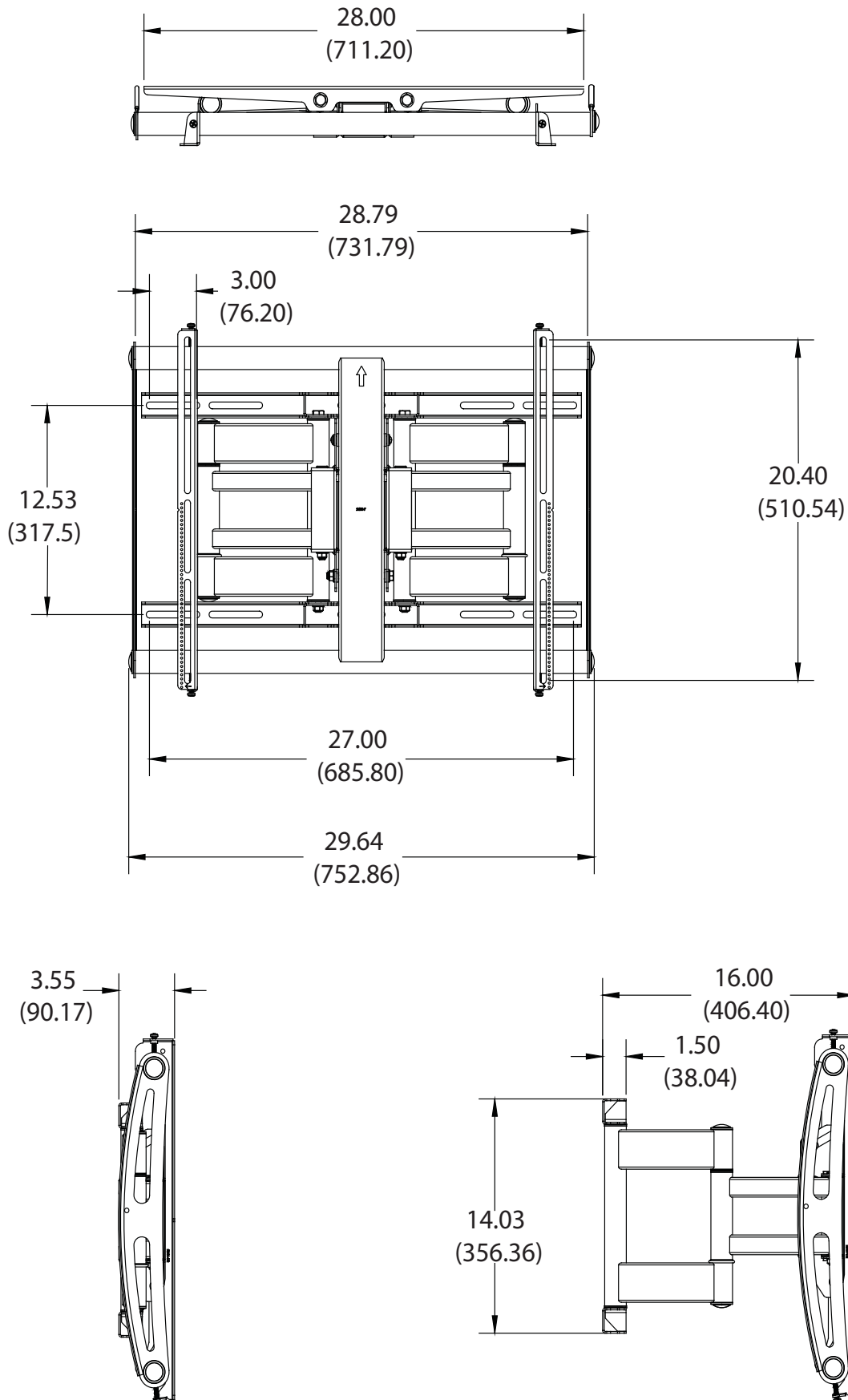



Warranty

PREMIER MOUNTS LIMITED LIFETIME WARRANTY

What and Who is Covered by this Limited Warranty and for How Long

Premier Mounts warrants this product to be free from defects in material and workmanship for the lifetime of the original installation of this product. The limited warranty is valid only for the original purchaser of the product.

What Premier Mounts Will Do

At the sole option of Premier Mounts, Premier Mounts will repair or replace any product or product part that is defective. If Premier Mounts chooses to replace a defective product or part, a replacement product or part will be shipped to you at no charge, but you must pay any labor costs.

What is Not Covered; Limitations

PREMIER MOUNTS DISCLAIMS ANY LIABILITY FOR DAMAGE TO MOUNTS, ADAPTERS, DISPLAYS, PROJECTORS, OTHER PROPERTY, OR PERSONAL INJURY RESULTING, IN WHOLE OR IN PART, FROM IMPROPER INSTALLATION, MODIFICATION, USE OR MISUSE OF ITS PRODUCTS.

PREMIER MOUNTS DISCLAIMS ALL OTHER WARRANTIES, EXPRESS OR IMPLIED, INCLUDING WARRANTIES OF MERCHANTABILITY AND FITNESS FOR A PARTICULAR PURPOSE. PREMIER MOUNTS IS NOT RESPONSIBLE FOR INCIDENTAL OR CONSEQUENTIAL DAMAGES, INCLUDING BUT NOT LIMITED TO, INABILITY TO USE ITS PRODUCTS OR LABOR COSTS FOR REMOVING AND REPLACING DEFECTIVE PRODUCTS OR PARTS. SOME STATES DO NOT ALLOW THE EXCLUSION OR LIMITATION OF INCIDENTAL OR CONSEQUENTIAL DAMAGES, SO THE ABOVE LIMITATION OR EXCLUSION MAY NOT APPLY TO YOU.

What Customers Must Do for Limited Warranty Service

If you discover a problem that you think may be covered by the warranty you MUST REPORT it in writing to the address below within thirty (30) days. Proof of purchase (an original sales receipt) from the original consumer purchaser must accompany all warranty claims. Warranty claims must also include a description of the problem, the purchaser's name, address, and telephone number. General inquiries can be addressed to Premier Mounts Customer Service at 1-800-368-9700. Warranty claims will not be accepted over the phone or by fax.

Premier Mounts
Attn: Warranty Claim
3130 E. Miraloma Avenue
Anaheim, CA 92806

How State Law Applies

THIS WARRANTY GIVES YOU SPECIFIC LEGAL RIGHTS, AND YOU MAY ALSO HAVE OTHER RIGHTS WHICH VARY FROM STATE TO STATE.

Free Manuals Download Website

<http://myh66.com>

<http://usermanuals.us>

<http://www.somanuals.com>

<http://www.4manuals.cc>

<http://www.manual-lib.com>

<http://www.404manual.com>

<http://www.luxmanual.com>

<http://aubethermostatmanual.com>

Golf course search by state

<http://golfingnear.com>

Email search by domain

<http://emailbydomain.com>

Auto manuals search

<http://auto.somanuals.com>

TV manuals search

<http://tv.somanuals.com>