

Celebrity

Owner's Manual

ATTENTION:
Please read the content
of your owner's manual
before operating your
scooter.



3&4 Wheel Scooters

The Ultimate In Style & Performance[®]

Pride
Mobility Products Corp.

*Exeter, PA
St. Catharines, ON*

1-800-800-8586

www.pridemobility.com

SAFETY GUIDELINES

Please read and follow all instructions in this owner's manual before attempting to operate your scooter for the first time. If there is anything in this manual you do not understand, or if you require additional assistance for set-up, contact your authorized Pride Provider.

Using your Pride product safely depends upon your diligence in following the warnings, cautions, and instructions in this owner's manual. Using your Pride product safely also depends upon your own good judgement and/or common sense, as well as that of your provider, caregiver, and/or healthcare professional. Pride is not responsible for injuries and/or damage resulting from any person's failure to follow the warnings, cautions, and instructions in this owner's manual. Pride is not responsible for injuries and/or damage resulting from any person's failure to exercise good judgement and/or common sense.

The symbols below are used throughout this owner's manual to identify warnings and cautions. It is very important for you to read and understand them completely.



WARNING! Failure to heed the warnings in this owner's manual may result in personal injury.



CAUTION! Failure to heed the cautions in this owner's manual may result in damage to your scooter.

CONTENTS

I. INTRODUCTION	4
II. SAFETY	6
III. EMI/RFI	14
IV. SPECIFICATIONS	16
V. YOUR CELEBRITY	18
VI. BATTERIES AND CHARGING	22
VII. OPERATION	26
VIII. COMFORT ADJUSTMENTS	28
IX. DISASSEMBLY AND ASSEMBLY	30
X. OPTIONAL ACCESSORIES	33
XI. BASIC TROUBLESHOOTING	34
XII. CARE AND MAINTENANCE	35
XIII. WARRANTY	37

I. INTRODUCTION

Welcome to Pride Mobility Products Corporation (Pride). Congratulations on the purchase of your new Pride Scooter. Your scooter design combines the most advanced state-of-the-art components with modern, attractive styling. We are certain that the design features and trouble-free operation will add convenience to your daily living and ensure complete satisfaction.

At Pride, your safety is important to us. Please read and follow all of the instructions in this manual before you attempt to operate your scooter for the first time. These instructions were produced for your benefit. Your understanding of these instructions is essential for the safe operation of your new Pride Scooter.

Pride is not liable for damage to property or personal injury arising out of the unsafe use of a Pride Scooter. Pride is also not liable for any property damage or personal injury arising out of the failure of any person and/or user to follow the instructions and recommendations set forth in this manual or any other instructions or recommendations contained in other scooter related literature issued by Pride or contained on the Pride Scooter itself.

This owner's manual is compiled from the latest specifications and product information available at the time of publication. We reserve the right to make changes as they become necessary. Any changes to our products may cause slight variations between the illustrations and explanations in this manual and the product you have purchased.

If you experience any problems with your scooter that you are not able to solve, or if you do not feel capable of safely following any of the instructions and/or recommendations contained in this manual, please contact your authorized Pride Provider for assistance.

Once you understand how to operate and take care of your scooter, we are certain that it will give you years of trouble-free service and enjoyment.

Information Exchange

We want to hear your questions, comments, and suggestions regarding this manual. We would also like to hear about the safety and reliability of your new Pride Scooter, and the service you received from your authorized Pride Provider.

Please notify us of any change of address so we can keep you apprised of important information regarding safety, new products, and new options that can increase your ability to use and enjoy your Pride Scooter. Please feel free to write us at the address below:

Pride Mobility Products Corporation
Attn: Customer Care Department
182 Susquehanna Avenue
Exeter, PA 18643-2694

customer@pridemobility.com
1-800-424-8205

I. INTRODUCTION

Pride Owners Club

As a Pride product owner, you are invited to register your product's warranty and enroll in the Pride Owners Club. You may do so by filling out and returning your enclosed registration card or by visiting Pride's web site at www.pridemobility.com. As a registered member, each time you visit our site you will have access to the most interactive and honest educational venue available today for people with mobility needs, their families, and friends.

From our home page, click on the button that reads "Owners Club" to enter a page dedicated to current and potential Pride product owners. You will gain access to interviews, stories, recreation ideas, daily living tips, product and funding information, and interactive message boards. Message boards invite you to speak with other Pride customers as well as Pride representatives who are available to assist you with any questions or concerns you may have.

My Authorized Pride Provider Is:

Name: _____

Address: _____

Phone Number: _____

Quick Reference Information:

Scooter Model: _____

Serial Number: _____

Purchase Date: _____

NOTE: If you ever lose or misplace your product registration card or this owner's manual, contact us and we will be glad to send you a new one immediately.

II. SAFETY

GENERAL



WARNING! Do not operate your new scooter for the first time without completely reading and understanding this owner's manual.

Your Scooter is a state-of-the-art life-enhancement device designed to increase mobility. Pride provides an extensive variety of products to best fit the individual needs of the scooter user. Please be aware that the final selection and purchasing decision regarding the type of scooter to be used is the responsibility of the scooter user who is capable of making such a decision and his/her healthcare professional (i.e., medical doctor, physical therapist, etc.).

The contents of this manual are based on the expectation that a mobility device expert has properly fitted the scooter to the user and has assisted the prescribing healthcare professional and/or the authorized Pride Provider in the instruction process for the use of the product.

There are certain situations, including some medical conditions, where the scooter user will need to practice operating the scooter in the presence of a trained attendant. A trained attendant can be defined as a family member or care professional specially trained in assisting a scooter user in various daily living activities.

As you begin using your scooter during daily activities, you will probably encounter situations in which you will need some practice. Simply take your time and you will soon be in full and confident control as you maneuver through doorways, on and off lifts, up and down ramps, and over moderate terrain.

Below are some precautions, tips, and other safety considerations that will help the user become accustomed to operating the scooter safely.

MODIFICATIONS

Pride has designed and engineered your scooter to provide maximum mobility and utility. A wide range of accessories is available from your authorized Pride Provider to further customize your scooter to better suit your needs and/or preferences. However, under no circumstances should you modify, add, remove, or disable any feature, part, or function of your scooter.



WARNING! Do not modify your scooter in any way not authorized by Pride. Unauthorized modifications may result in personal injury and/or damage to your scooter.

REMOVABLE PARTS



WARNING! Do not attempt to lift or move your scooter by any of its removable parts. Personal injury and damage to the scooter may result.

ELECTROMAGNETIC FIELDS

Your scooter's road performance features may be influenced by electromagnetic fields caused by cellular telephones or other radiating devices, such as hand-held radios, radio and television stations, wireless computer links, microwave sources, and paging transmitters. Learn more about this topic in III. "EMI-RFI."

II. SAFETY

PRE-RIDE SAFETY CHECK

Get to know the feel of your scooter and its capabilities. Pride recommends that you perform a safety check before each use to make sure your scooter operates smoothly and safely. For details on how to perform these necessary inspections, see XII. "Care and Maintenance."

Perform the following inspections prior to using your scooter:

- Check for proper tire inflation (if equipped with pneumatic tires).
- Check all electrical connections. Make sure they are tight and not corroded.
- Check all harness connections. Make sure they are secured properly.
- Check the brakes.
- Check battery charge.

If you discover a problem, contact your authorized Pride Provider for assistance.

TIRE INFLATION

If your scooter is equipped with pneumatic tires, you should check or have the air pressure checked at least once a week. Proper inflation pressures will prolong the life of your tires and help ensure the smooth operation of your scooter.



WARNING! It is critically important that 30-35 psi tire pressure be maintained in pneumatic tires at all times. Do not underinflate or overinflate your tires. Low pressure may result in loss of control, and overinflated tires may burst. Failure to maintain 30-35 psi tire pressure in pneumatic tires at all times may result in tire and/or wheel failure, causing serious personal injury and/or damage to your scooter.

WARNING! Inflate your scooter tires from a regulated air source with an available pressure gauge. Inflating your tires from an unregulated air source could overinflate them, resulting in a burst tire and/or personal injury.

WEIGHT LIMITATIONS

Your scooter is rated for a maximum weight capacity. Refer to the specifications table for information.



WARNING! Exceeding the weight capacity voids your warranty and may result in personal injury and damage to your scooter. Pride will not be held responsible for injuries and/or property damage resulting from failure to observe weight limitations.

WARNING! Do not carry passengers on your scooter. Carrying passengers may result in personal injury and/or property damage.

INCLINE INFORMATION

More and more buildings have ramps with specified degrees of inclination, designed for easy and safe access. Some ramps may have turning switchbacks (180-degree turns) that require you to have good cornering skills on your scooter.

- Proceed with extreme caution as you approach the downgrade of a ramp or other incline.
- Take wide swings with your scooter around any tight corners. If you do that, the scooter's rear wheels will follow a wide arc, not cut the corner short, and not bump into or get hung up on any railing corners.
- When driving down a ramp, keep the scooter's speed adjustment set to the slowest speed setting to ensure a safely controlled descent.
- Avoid sudden stops and starts.

II. SAFETY

When climbing an incline, try to keep your scooter moving. If you must stop, start up again slowly, and then accelerate cautiously. When driving down an incline, do so by setting the speed adjustment dial to the slowest setting and driving in the forward direction only. If your scooter starts to move down the incline faster than you anticipated or desired, allow it to come to a complete stop by releasing the throttle control lever. Then push the throttle control lever forward slightly to ensure a safely controlled descent.

WARNING! When climbing an incline, do not zigzag or drive at an angle up the face of the incline. Drive your scooter straight up the incline. This greatly reduces the possibility of a tip or a fall. Always exercise extreme caution when negotiating an incline.



WARNING! Do not drive your scooter across the side of a hill or diagonally up or down a hill; do not stop, if possible, while driving up or down an incline.

WARNING! You should not travel up or down a potentially hazardous incline (i.e., areas covered with snow, ice, cut grass, or wet leaves).

WARNING! When on any sort of an incline or decline, never place the scooter in freewheel mode while seated on it or standing next to it.

WARNING! Even though your scooter is capable of climbing slopes greater than those illustrated in figures 1 and 2, do not, under any circumstances, exceed the incline guidelines or any other specifications presented in this manual. Doing so could cause instability in your scooter, resulting in personal injury and/or damage to your scooter.

Handicap public access ramps are not subject to government regulation in all countries, and therefore do not necessarily share the same standard percent of slope. Other inclines may be natural or, if man-made, not designed specifically for scooters. Figures 1 and 2 illustrate your scooter's stability and its ability to climb grades under various weight loads and under controlled testing conditions.

These tests were conducted with the scooter's seat in the highest position and adjusted rearward on the seat base to its farthest rearward position. Use this information as a guideline. Your scooter's ability to travel up inclines is affected by your weight, your scooter's speed, your angle of approach to the incline, and your scooter setup.

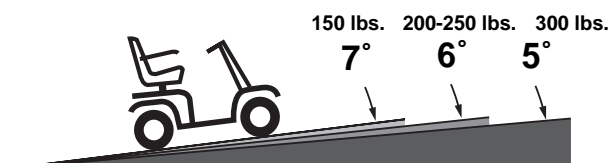

Figure 1. (3-wheel) Maximum Recommended Incline Angles

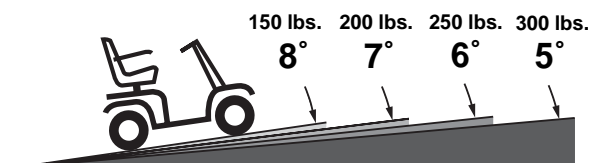

Figure 2. (4-wheel) Maximum Recommended Incline Angles



WARNING! Any attempt to climb or descend a slope steeper than what is shown in figures 1 and 2 may put your scooter in an unstable position and cause it to tip, resulting in personal injury.



WARNING! Never carry an oxygen tank weighing more than 15 lbs. Never fill the rear basket with contents exceeding 15 lbs.

II. SAFETY

When you approach an incline, it is best to lean forward. See figures 3 and 3A. This shifts the center of gravity of you and your scooter toward the front of the scooter for improved stability.

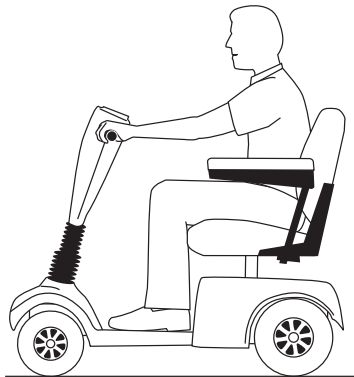

Figure 3. Normal Driving Position

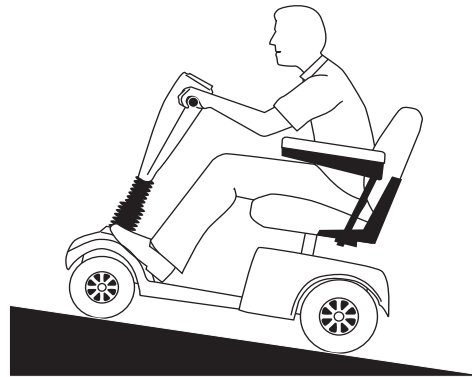

Figure 3A. Increased Stability Driving Position

CORNERING INFORMATION

Excessively high cornering speeds can create the possibility of tipping. Factors which affect the possibility of tipping include, but are not limited to, cornering speed, steering angle (how sharply you are turning), uneven road surfaces, inclined road surfaces, riding from an area of low traction to an area of high traction (such as passing from a grassy area to a paved area – especially at high speed while turning), and abrupt directional changes. High cornering speeds are not recommended. If you feel that you may tip over in a corner, reduce your speed and steering angle (i.e., lessen the sharpness of the turn) to prevent your scooter from tipping.



WARNING! When cornering sharply, reduce your speed. When using your scooter at higher speeds, do not corner sharply. This greatly reduces the possibility of a tip or fall. To avoid personal injury or property damage, always exercise common sense when cornering.

BRAKING INFORMATION

Your scooter is equipped with two powerful brake systems:

1. Regenerative: Uses electricity to rapidly slow the vehicle when the throttle control lever returns to the center/stop position.
2. Disc Park Brake: Activates mechanically after regenerative braking slows the vehicle to near stop, or when power is removed from the system for any reason.

II. SAFETY

OUTDOOR DRIVING SURFACES

Your scooter is designed to provide optimum stability under normal driving conditions—dry, level surfaces composed of concrete, blacktop, or asphalt. However, Pride recognizes that there will be times when you will encounter other surface types. For this reason, your scooter is designed to perform admirably on packed soil, grass, and gravel. Feel free to use your scooter safely on lawns and in park areas.

- Reduce your scooter's speed when driving on uneven terrain and/or soft surfaces.
- Avoid tall grass that can become tangled in the running gear.
- Avoid loosely packed gravel and sand.
- If you feel unsure about a driving surface, avoid that surface.

PUBLIC STREETS AND ROADWAYS



WARNING! You should not operate your scooter on public streets and roadways. Be aware that it may be difficult for traffic to see you when you are seated on your scooter. Obey all local pedestrian traffic rules. Wait until your path is clear of traffic, and then proceed with extreme caution.

NOTE: Safety accessories like fluorescent flags are available to order from your authorized Pride Provider.

STATIONARY OBSTACLES (STEPS, CURBS, ETC.)

WARNING! Do not drive near raised surfaces, unprotected ledges, and/or drop-offs (curbs, porches, stairs, etc.).

WARNING! Do not attempt to have your scooter climb or descend an obstacle that is inordinately high. Serious personal injury and/or damage may result.



WARNING! Do not attempt to have your scooter proceed backward down any step, curb, or other obstacle. This may cause the scooter to tip and cause personal injury.

WARNING! Be sure your scooter is traveling perpendicular to any curb you may be required to ascend or descend. See figures 4 and 4A.

WARNING! Do not attempt to negotiate a curb that has a height greater than 2 in.

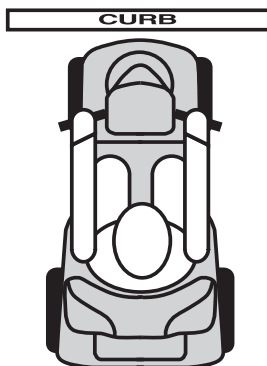

Figure 4. Correct Curb Approach

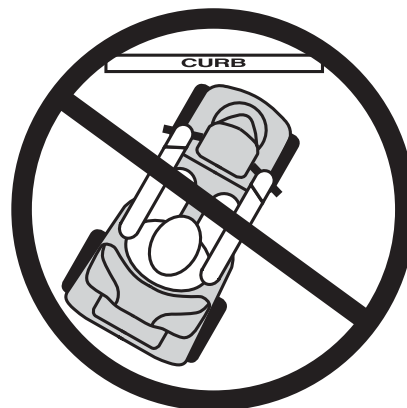

Figure 4A. Incorrect Curb Approach

II. SAFETY

INCLEMENT WEATHER PRECAUTIONS



WARNING! Pride recommends that you do not operate your scooter in icy or slippery conditions or on salted surfaces (i.e., walks or roads). Such use may result in an accident, personal injury, or adversely affect the performance and safety of your scooter.

WARNING! Do not operate or store your scooter where it may be exposed to inclement weather conditions such as rain, snow, mist, and below freezing temperatures (such as storage on an outside car/van lift). Attempting to operate the scooter in such conditions can damage the electronics and potentially result in loss of control.

FREEWHEEL MODE

Your scooter is equipped with a manual freewheel lever that, when pulled up, allows the scooter to be pushed. For more information about how to place your scooter into and out of freewheel mode, see V. “Your Celebrity.”



WARNING! When your scooter is in freewheel mode, the braking system is disengaged.

- Disengage the drive motors only on a level surface.
- Ensure the key is removed from the key switch.
- Stand behind the scooter to engage or disengage freewheel mode. Never sit on a scooter to do this.
- After you have finished pushing your scooter, always return it to the drive mode to lock the brakes.

Failure to heed the above could result in personal injury and/or damage to your scooter.

STAIRS AND ESCALATORS

Scooters are not designed to travel up or down stairs or escalators. Always use an elevator.



WARNING! Do not use your scooter to negotiate steps or escalators. You may cause injury to yourself and to others and/or damage your scooter.

DOORS

- Determine if the door opens toward or away from you.
- Use your hand to turn the knob or push the handle or push-bar.
- Drive your scooter gently and slowly forward to push the door open. Or drive your scooter gently and slowly rearwards to pull the door open.

ELEVATORS

Modern elevators have a door edge safety mechanism that, when pushed, reopens the door(s).

- If you are in the doorway of an elevator when the door(s) begin to close, push on the rubber door edge or allow the rubber door edge to contact the scooter and the door will reopen.
- Use care that pocketbooks, packages, or scooter accessories do not become caught in elevator doors.

II. SAFETY

LIFT/ELEVATION PRODUCTS

If you will be traveling with your scooter, you may find it necessary to use a lift/elevation product to aid in transportation. Pride recommends that you closely review the instructions, specifications, and safety information set forth by the manufacturer of the lift/elevation product before using that product.



WARNING! Never sit on your scooter when it is being used in connection with any type of lift/elevation product. Your scooter was not designed with such use in mind, and any damage or injury incurred from such use is not the responsibility of Pride.

BATTERIES

In addition to following the warnings below, be sure to comply with all other battery handling information.



WARNING! Scooter batteries are heavy (refer to specifications table). Lifting weight beyond your capacity could result in personal injury. If necessary, get someone physically able to lift the scooter batteries for you.

WARNING! Battery posts, terminals, and related accessories contain lead and lead compounds. Wash hands after handling.

WARNING! Always protect the batteries from freezing and never charge a frozen battery. Charging a frozen battery may result in personal injury and/or damage to the battery.

WARNING! RED (+) cables must be connected to positive (+) battery terminals/posts. BLACK (-) cables must be connected to negative (-) battery terminals/posts. Failure to connect your battery harnesses in the proper manner may result in personal injury and/or damage to your scooter. REPLACE cables immediately if damaged.

BATTERY DISPOSAL AND RECYCLING

If you encounter a damaged or cracked battery, immediately enclose it in a plastic bag and call your authorized Pride Provider for instructions on disposal. Your authorized Pride Provider will also have the necessary information on battery recycling, which is our recommended course of action.

MOTOR VEHICLE TRANSPORT

Currently, there are no standards approved for tie-down systems in a moving vehicle of any type to transport a person while seated in a scooter.

Although your scooter may be equipped with a positioning belt, this belt is not designed to provide proper restraint during motor vehicle transport. Anyone traveling in a motor vehicle should be properly secured in the motor vehicle seat with safety belts fastened securely.



WARNING! Do not sit on your scooter while it is in a moving vehicle. Personal injury and/or property damage may result.

WARNING! Always be sure your scooter and its batteries are properly secured when it is being transported. Failure to do so may result in personal injury and/or damage to your scooter.

PREVENTING UNINTENDED MOVEMENT



WARNING! If you anticipate being seated in a stationary position for an extended period of time, turn off the power. This will prevent unexpected motion from inadvertent throttle control lever contact. Failure to do so may result in personal injury.

II. SAFETY

GETTING ONTO AND OFF OF YOUR SCOOTER

Getting onto and off of your scooter requires a good sense of balance. Please observe the following safety tips when getting onto and off of your scooter:

- Ensure that your scooter is not in freewheel mode. See V. “Your Celebrity.”
- Make certain that the seat is locked into place and the key is removed from the key switch.
- The seat armrests of the seat can be flipped up to make getting onto and off of the scooter easier.



WARNING! Position yourself as far back as possible in the scooter seat to prevent the scooter from tipping and causing injury.

WARNING! Avoid using your armrests for weight bearing purposes. Such use may cause the scooter to tip and cause personal injury.

WARNING! Avoid putting all of your weight on the floorboard. Such use may cause the scooter to tip and cause personal injury.

REACHING AND BENDING

Avoid reaching or bending while driving your scooter. When reaching, bending, or leaning while seated on your scooter, it is important to maintain a stable center of gravity and keep the scooter from tipping. Pride recommends that the scooter user determine his/her personal limitations and practice bending and reaching in the presence of a qualified healthcare professional.



WARNING! Do not bend, lean, or reach for objects if you have to pick them up from the floor by reaching down between your knees. Movements such as these may change your center of gravity and the weight distribution of the scooter and cause your scooter to tip, possibly resulting in personal injury. Keep your hands away from the tires when driving.

PRESCRIPTION DRUGS/PHYSICAL LIMITATIONS

The scooter user must exercise care and common sense when operating his/her scooter. This includes awareness of safety issues when taking prescribed or over-the-counter drugs or when the user has specific physical limitations.



WARNING! Consult your physician if you are taking prescribed or over-the-counter medication or if you have certain physical limitations. Some medications and limitations may impair your ability to operate your scooter in a safe manner.

ALCOHOL

The scooter user must exercise care and common sense when operating his/her scooter. This includes awareness of safety issues while under the influence of alcohol.



WARNING! Do not operate your scooter while you are under the influence of alcohol, as this may impair your ability to drive safely.

POSITIONING BELTS

Your authorized Pride Provider, therapist(s), and other healthcare professionals are responsible for determining your requirement for a positioning belt in order to operate your scooter safely.



WARNING! If you require a positioning belt to safely operate your scooter, make sure it is fastened securely. Serious personal injury may result if you fall from the scooter.

III. EMI/RFI

EMI/RFI WARNINGS

Laboratory tests performed by the Food and Drug Administration (FDA) have shown that radio waves can cause unintended motion of electric mobility vehicles. Radio waves are a form of electromagnetic energy (EM). When electromagnetic energy adversely affects the operation of an electrical device, that adverse effect is called *Electromagnetic Interference (EMI)* or *Radio Frequency Interference (RFI)*.



WARNING! Radio waves may interfere with the control of scooters.

EMI/RFI FREQUENTLY ASKED QUESTIONS (FAQS)

The following FAQs summarize what you should know about EMI/RFI. Use this information to minimize the risk that EMI/RFI will adversely affect your mobility vehicle.

Where do radio waves come from?

Radio waves are emitted from the antennas of cellular phones, mobile two-way radios (such as walkie-talkies and CBs), radio stations, TV stations, amateur radio (HAM) transmitters, wireless computer links, microwave sources, and paging transmitters. Radio waves are a form of electromagnetic energy (EM). EM is more intense closer to transmitting antennas, which are sources of emission. The greater the transmission strength, the greater the concern to electric mobility vehicle users.

If EMI/RFI affects my mobility vehicle, what kind of motion should I expect?

This is difficult to predict. The answer would depend on a number of factors:

- The strength of the radio waves.
- The construction of your particular mobility vehicle.
- The location of your mobility vehicle (whether it is on the level ground or on an incline).
- Whether or not your mobility vehicle is in motion.

The motion of any electric mobility vehicle affected by EMI/RFI can be erratic. The mobility vehicle may come to a sudden stop or move in an uncontrolled manner. Also, it is possible for EMI/RFI to release the brakes of an electric mobility vehicle. Some intense EMI/RFI can even damage the control system components of an electric mobility vehicle.

Is there any way to know for certain whether or not radio waves are the cause of any unintended mobility vehicle motion?

Unfortunately, EMI/RFI may be difficult to recognize, because the signals from radio sources are invisible and may be intermittent. However, the FDA recommends that you report all incidents of unintended motion or unintended brake release of your mobility vehicle to its manufacturer and, if possible, determine whether or not there was a radio wave source nearby at the time of the incident.

One precaution you can take against unintended motion of your mobility vehicle is to make certain that you or someone else is not the cause of the unintended motion.

- Turn off your mobility vehicle by removing the key from the key switch when you are getting onto or off of your mobility vehicle.
- Never leave the key in the key switch of an unattended mobility vehicle.
- By following these steps, you greatly reduce the risk of you or anyone else inadvertently bumping the throttle control levers and causing the mobility vehicle to move unintentionally.

Has anyone been injured by the erratic, unintended motion of an electric mobility vehicle?

The FDA has reports of injuries that resulted from uncontrolled motion of electric mobility vehicles, but it is not clear just how many of those injuries were actually caused by EMI/RFI.

III. EMI/RFI

Are all electric mobility vehicles susceptible to EMI/RFI?

Each make and model of electric mobility vehicle differs in its ability to resist EMI/RFI. Every mobility vehicle has a particular level of resistance to EMI/RFI. This resistance is measured in volts per meter (V/m). A higher resistance level offers greater protection against EMI/RFI. In other words, an electric mobility vehicle with a high resistance level is less likely to be affected by a strong radio source than is an electric mobility vehicle with a low resistance level.

What is the FDA doing about the problem?

The FDA has written to electric mobility vehicle manufacturers and requested that those manufacturers test their new mobility vehicle models to be certain that they provide a reasonable degree of resistance against EMI/RFI. The FDA has stated that all newly manufactured electric mobility vehicle models should have a resistance level of at least 20 V/m. This level of resistance provides a reasonable degree of protection against the common sources of EMI/RFI.

The FDA has also requested or recommended that:

- Electric mobility vehicle manufacturers clearly label new products with their resistance level or state that the resistance level is not known.
- The labeling or informational material supplied with new electric mobility vehicles must explain what the resistance level means and warn users about the possibility of EMI/RFI and how to avoid it.
- Electric mobility vehicle manufacturers undertake an educational program to inform electric mobility vehicle users and their caregivers about the problems associated with EMI/RFI and about the actions they can take to minimize the risk of EMI/RFI.
- While there is no exact way to tell if your mobility vehicle is totally safe, an immunity level of 20 V/m is generally achievable and useful. This product has been tested and passed at an immunity level of 20 V/m.

What can I do to find out if my mobility vehicle is likely to be affected by EMI/RFI?

If you have had your mobility vehicle for some time and have not experienced any unintended motion, it is not likely that you will have a problem in the future. However, it is always possible that EMI/RFI problems could arise if you are close to a source of radio waves. Therefore, it is very important for you to be alert to this possibility. The mobility vehicle meets or exceeds a resistance level of at least 20 V/m.

What can I do to reduce the risk of my mobility vehicle being affected by EMI/RFI?

Here are some precautions you can take:

- Do not turn on or use hand-held personal communications devices, such as citizens band (CB) radios and cellular phones, while your mobility vehicle is turned on.
- Be aware of nearby radio wave transmitters, such as radio or TV stations and hand-held or mobile two-way radios. Try not to operate your mobility vehicle too close to those transmitters. For example, if you are on an electric mobility vehicle with a resistance level of at least 20 V/m, you should remain at least three feet from a hand-held two-way radio and at least ten feet from a mobile two-way radio.
- Be aware that adding accessories and/or components, or modifying your mobility vehicle in any way, may change its EMI/RFI resistance level and may make it more susceptible to interference from radio wave sources.

What should I do if my mobility vehicle moves unexpectedly?

If unintended motion or unintended brake release occurs, turn off your mobility vehicle (by removing the key) as soon as it is safe to do so.

If my mobility vehicle moves unintentionally, where should I report the incident?

Call Pride Customer Care at 1-800-424-8205 to report the incident.

IV. SPECIFICATIONS

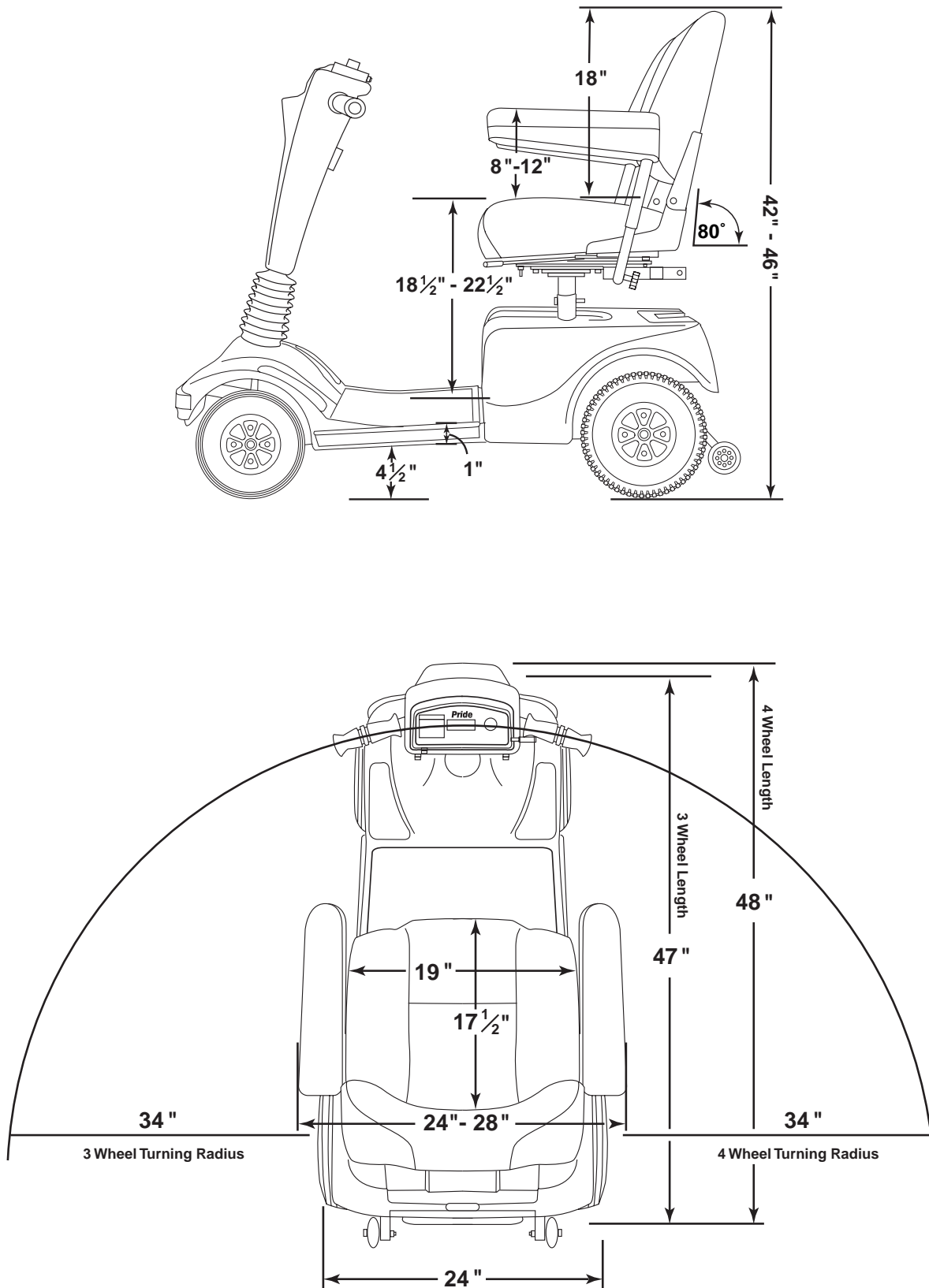

Figure 5. Celebrity Dimensions

IV. SPECIFICATIONS

Model Numbers	SC-400 (Candy Apple Red), SC-401 (Hunter Green), SC-402 (Viper Blue) SC-440 (Candy Apple Red), SC-441 (Hunter Green), SC-442 (Viper Blue)												
Length	48in. (4 wheel), 47in. (3 wheel)												
Width	24in.												
Tires	Type: Pneumatic Front: 3in. x 9in. Rear: 4in. x 10in.												
Weight Capacity	300 lbs. Maximum												
Battery Type (Batteries not included)	Two 12V, 32AH, U-1 type, AGM or Gel-Cell												
Horsepower	1.4 hp (peak)												
Charger	Onboard Charger												
Speed (max)	Variable up to 5.25 mph (60% reverse)												
Maximum Grade	Please refer to figures 1 and 2.												
Range	20-25 miles per charge with 32AH batteries												
Turning Radius	34in. (3 and 4 wheel)												
Body Colors	Painted: Candy Apple Red, Hunter Green, or Viper Blue												
Seating	<p>Style: Medium back w/Sliders</p> <p>Dimensions: 18.5in. width (usable) x 19in. height (usable) x 19in. depth</p> <p>Seat Cover Material: Vinyl or Fabric, Gray, Fawn, or Camel</p> <p>Armrests: Match</p> <p>User Adjustable seat height from ground: 24in. to 28in.</p> <p>User Adjustable seat height from scooter deck: 18.5in. to 22.5in.</p>												
Included Features	Dynamic rear suspension system, Adjustable seat height and positioning, Height adjustable armrest, Sliding seat, Slime® Tire sealant, Energy-saving auto shutoff feature, Front headlight												
Brakes	Electronic regenerative braking and electromechanical disc brake												
Rear Wheel Drive	Sealed Transaxle, 24 VDC Motor												
Wheels	Black												
Tiller Type	Infinitely adjustable between the forward stop and the scooter deck												
Freewheel Mechanism	Freewheel release lever located on transaxle												
Weight of Scooter	<p>TOTAL weight with batteries = 165.0 lbs. (3 wheel) 171.0 lbs. (4 wheel)</p> <p>TOTAL weight without = 115.0 lbs. (3 wheel)/121.0 lbs. (4 wheel)</p> <p>Component breakdown:</p> <table style="width: 100%; border: none;"> <tr> <td style="width: 60%;">Front section:</td> <td style="text-align: right;">35.0 lbs. (3 wheel)</td> </tr> <tr> <td></td> <td style="text-align: right;">45.0 lbs. (4 wheel)</td> </tr> <tr> <td>Rear section (with utility tray):</td> <td style="text-align: right;">45.0 lbs. (3 wheel and 4 wheel)</td> </tr> <tr> <td>Rear plastic shroud:</td> <td style="text-align: right;">3.5 lbs.</td> </tr> <tr> <td>Seat:</td> <td style="text-align: right;">35.0 lbs.</td> </tr> <tr> <td>Batteries (two are required):</td> <td style="text-align: right;">25.0 lbs. ea. (12V, 32AH)</td> </tr> </table>	Front section:	35.0 lbs. (3 wheel)		45.0 lbs. (4 wheel)	Rear section (with utility tray):	45.0 lbs. (3 wheel and 4 wheel)	Rear plastic shroud:	3.5 lbs.	Seat:	35.0 lbs.	Batteries (two are required):	25.0 lbs. ea. (12V, 32AH)
Front section:	35.0 lbs. (3 wheel)												
	45.0 lbs. (4 wheel)												
Rear section (with utility tray):	45.0 lbs. (3 wheel and 4 wheel)												
Rear plastic shroud:	3.5 lbs.												
Seat:	35.0 lbs.												
Batteries (two are required):	25.0 lbs. ea. (12V, 32AH)												
Front-to-Rear Lockup	Lock pin and lever system												
Ground Clearance	4.5in.												
Optional Accessories	Cane/crutch holder, walker holder, rearview mirror, cup holder, rear basket (square), oxygen holder, power seat assembly, front bumper, rear bumper, front basket, fully directional light package												

V. YOUR CELEBRITY

Your Celebrity is a motorized electric scooter designed to enhance your personal mobility. Your Celebrity is an indoor/outdoor scooter that was designed to travel primarily on smooth surfaces such as sidewalks, roads, parking lots, floors, and driveways. For easy transportation or storage, you can disassemble your Celebrity into 6 components. See figure 6.



Figure 6. Celebrity Components

CONTROL CONSOLE ASSEMBLY



WARNING! Do not expose the control console assembly to moisture. In the event that the control console assembly does become exposed to moisture, do not attempt to operate your scooter until the control console assembly has dried thoroughly.

The control console assembly houses all of the controls you need to drive your Celebrity, including the key, the key switch, the speed control dial, the throttle control lever, the battery condition meter, the horn button, and the light switch. See figure 7.

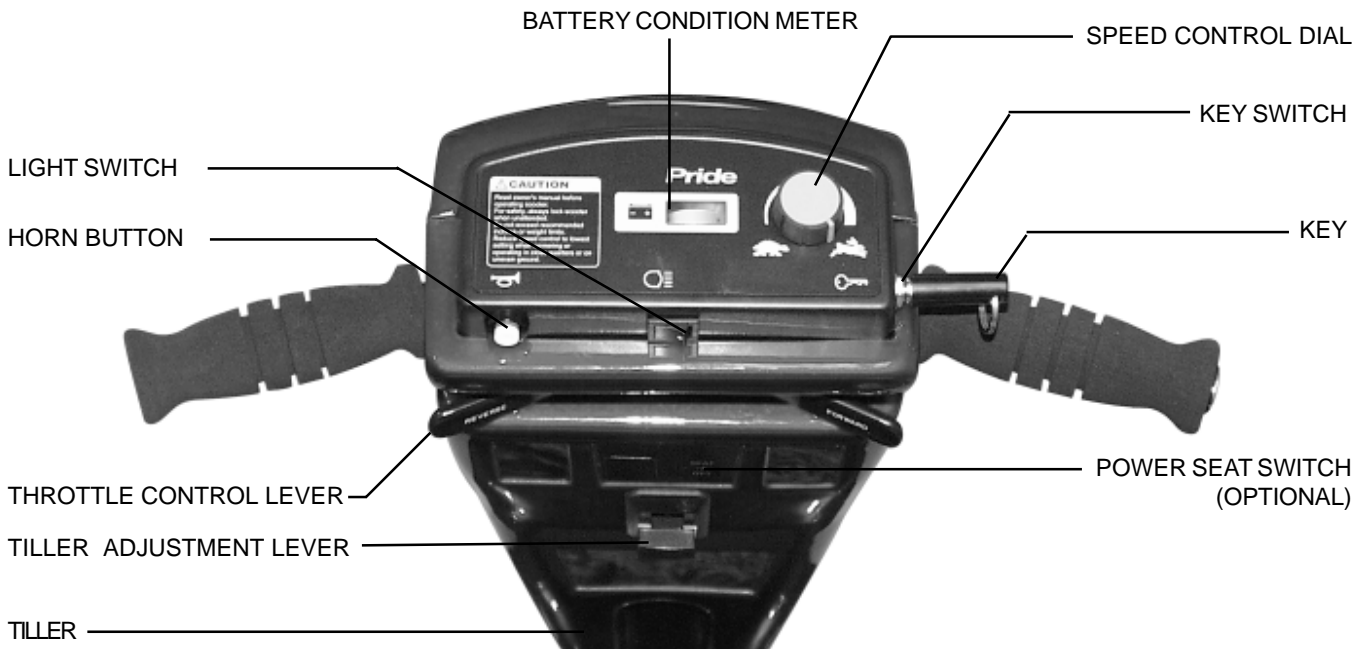

Figure 7. Control Console Assembly

V. YOUR CELEBRITY

Key Switch



WARNING! If the key is removed from the key switch while your scooter is in motion, the electronic brakes engage and your scooter comes to an abrupt stop!

- Fully insert the key into the key switch to power up (turn on) your Celebrity.
- Pull the key out to power down (turn off) your Celebrity.

Speed Control Dial

This control dial allows you to preselect and limit your Celebrity's top speed.

- The image of the tortoise represents the slowest speed setting.
- The image of the hare represents the fastest speed setting.

Throttle Control Lever

This lever allows you to control the forward speed and the reverse speed of your Celebrity up to the maximum speed you preset with the speed control dial.

- Place your right hand on the right handgrip and your left hand on the left handgrip.
- Use your right thumb to push the right side of the lever to disengage your Celebrity's brakes and move forward.
- Release the lever and allow your Celebrity to come to a complete stop before pushing the other side of the lever to move in reverse.
- When the throttle is completely released, it automatically returns to the center "stop" position and engages your Celebrity's brakes.

Battery Condition Meter

Whenever you have the key fully inserted, this meter gives an approximate reading of your Celebrity's battery voltage.

Horn Button

- The key must be fully inserted into the key switch for the horn to be operational.
- This button activates a warning horn.
- Do not hesitate to use the warning horn when its use could prevent accident or injury.

Light Switch

This switch controls your Celebrity's lighting system.

- Press this switch once to turn on the lights.
- Press it again to turn off the lights.

V. YOUR CELEBRITY

REAR SECTION

The onboard battery charger, the charger power cord, the batteries, the electronic controller assembly, the main circuit breaker, the manual freewheel lever, and the motor/transaxle assembly are located beneath the shroud on the rear section of your Celebrity. See figures 8 and 9. Refer to IX. "Disassembly and Assembly" for instructions on removing the rear shroud.

Onboard Battery Charger

The onboard battery charger converts household current (AC) to direct current (DC) and charges the batteries of your Celebrity. See VI. "Batteries and Charging."

- The charger is located on the utility tray. See figure 8.
- The charger is a gray-colored plastic box with a green LED indicator on the exterior of the case.

Batteries

The batteries store the electrical energy that powers your Celebrity. See VI. "Batteries and Charging."

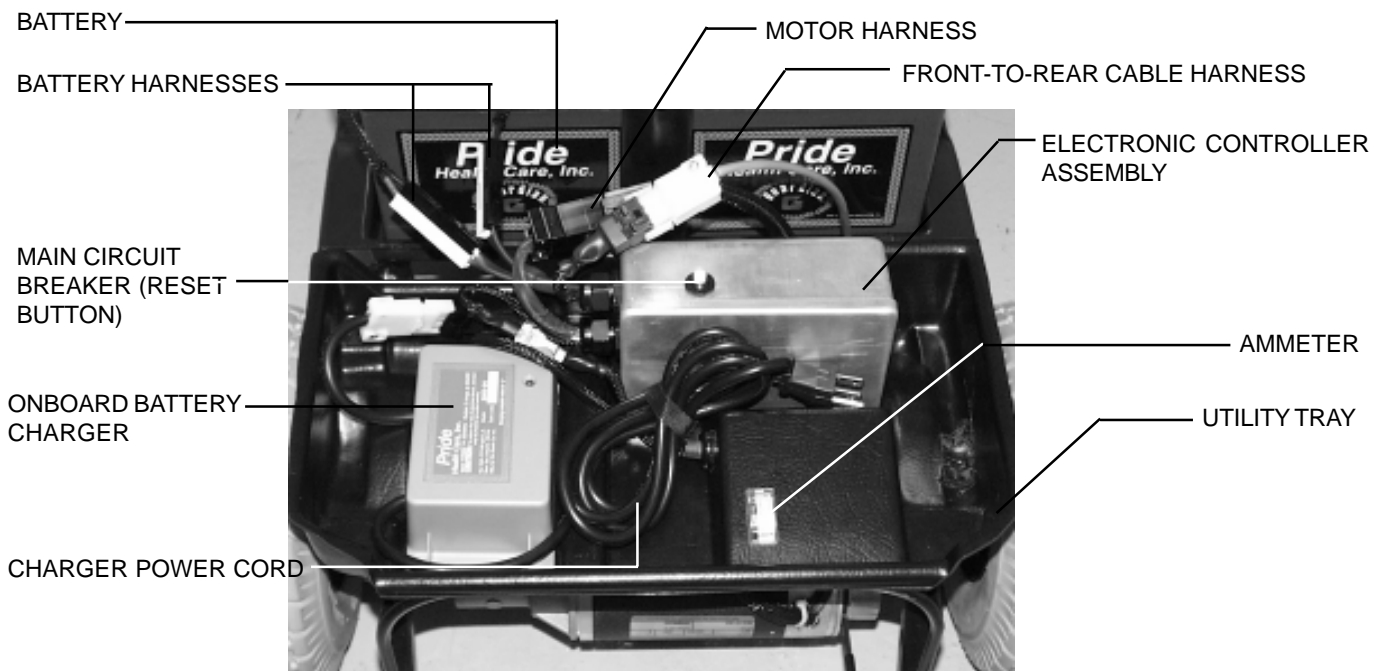

Figure 8. Utility Tray Components

Electronic Controller Assembly

The electronic controller assembly is located behind the batteries and at the forward right corner of the Celebrity's rear section. This assembly receives electrical signals from the console controls and sends power to the motor, the brakes, and the lighting system.

Main Circuit Breaker

When the voltage in your Celebrity's batteries becomes low or your Celebrity is heavily strained because of excessive loads or steep inclines, the main circuit breaker may trip to protect your Celebrity's motor and electronics from damage.

V. YOUR CELEBRITY

Do not expose the electronic controller assembly to moisture. In the event that the electronic controller assembly does become exposed to moisture, do not attempt to operate your Celebrity until the assembly has thoroughly dried.

- The main circuit breaker (reset button) is mounted on the electronic controller assembly cover. See figure 8.
- The main circuit breaker reset button pops out when the breaker trips.
- When the breaker trips, the entire electrical system of your Celebrity is shut down.
- Allow a minute or so for your Celebrity's electronics to "rest."
- Push in the reset button to reset the breaker.
- If the breaker trips frequently, you may need to charge your batteries more often. You may also need to have your Pride Provider perform a load test on your Celebrity's batteries.
- If the main circuit breaker trips repeatedly, see your authorized Pride Provider for service.

Manual Freewheel Lever



WARNING! When your scooter is in freewheel mode, the braking system is disengaged.

- **Disengage the drive motors only on a level surface.**
- **Ensure the key is removed from the key switch.**
- **Stand behind the scooter to engage or disengage freewheel mode. Never sit on a scooter to do this.**
- **After you have finished pushing your scooter, always return it to the drive mode to lock the brakes.**

Failure to heed the above could result in personal injury and/or damage to your scooter.

Whenever you need, or want, to push your Celebrity for short distances, you can put it in manual freewheel mode.

- The manual freewheel lever is located on the end of the motor/transaxle assembly at the right rear of the Celebrity. See figure 9.
- Pull up on the manual freewheel lever to disable the drive system and the brake system.
- You will then be able to push your Celebrity.
- Push down on the manual freewheel lever to reengage the drive system and the brake system and take your Celebrity out of freewheel mode.

Motor/Transaxle Assembly

The motor/transaxle assembly is the electromechanical unit that converts the electrical energy of your Celebrity's batteries into the controlled mechanical energy that drives the Celebrity's wheels. See figure 9.

Anti-Tip Wheels

The anti-tip wheels are an integral and important safety feature of your Celebrity. Do not, under any circumstances, remove the anti-tip wheels from your Celebrity. See figure 9.



WARNING! Do not remove the anti-tip wheels or modify your scooter in any way that is not authorized by Pride.

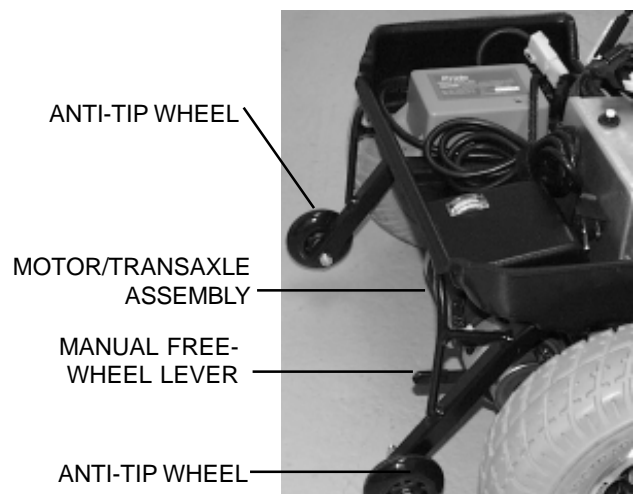

Figure 9. Rear Section

VI. BATTERIES AND CHARGING

Your Celebrity is equipped with two long-lasting, 12-volt, deep-cycle batteries that are sealed and maintenance free. They are recharged by an onboard 3-amp charging system designed for ease of use and convenience. See figure 8.

- Charge your Celebrity's batteries prior to using it for the first time.
- Keep your batteries fully charged to keep your Celebrity running trouble free.

Follow these easy steps to charge your batteries safely:

1. Position your scooter close to a standard wall outlet.
2. Remove the key from the key switch.
3. Extend the charger power cord and plug it into the wall outlet. See figure 10.



Figure 10. Charger Power Cord



WARNING! Never use an extension cord to plug in your battery charger. Plug the charger directly into a properly wired standard wall outlet.



WARNING! Removal of the grounding prong can create an electrical hazard. If necessary properly install an approved 3-prong adaptor to an electrical outlet having 2-pronged plug access. Failure to heed could result in personal injury and or property damage.

NOTE: There is a charger inhibit on your scooter. The scooter will not run and the battery condition meter will not operate while the batteries are charging.

4. It is recommended that you charge your batteries for 8 to 14 hours. You can check this periodically by the battery condition meter on the control console assembly. However, you must first unplug the battery charger and then insert the key. The battery condition meter on the control console assembly indicates the approximate strength of your batteries. When fully charged, the meter reads 24 volts. You can also check the charge by the ammeter which is located on the utility tray under the rear shroud. The battery charger must be plugged into a wall outlet to obtain a reading. When the amperage reading is at or near zero (0) amps, the battery charging is complete. See figure 11.
5. When the batteries are fully charged, unplug the charger power cord from the wall outlet, then coil the cord and store it under the utility tray lid.



Figure 11. Ammeter Indicates Battery Is Fully Charged

VI. BATTERIES AND CHARGING

FREQUENTLY ASKED QUESTIONS (FAQS)

How does the charger work?

When your Celebrity's battery voltage is low, the charger works harder and sends more electrical current to the batteries to bring up their charge. As the voltage of the batteries approaches a full charge, the charger sends less and less electrical current to the batteries. When the batteries are fully charged, the current being sent to them from the charger is at nearly zero amperage. Therefore, when the charger is plugged in, it maintains the charge on your Celebrity's batteries, but it does not overcharge them. We do not recommend that you charge your Celebrity's batteries for more than 24 consecutive hours.

What does the LED on the charger indicate?

The green LED turns on after the batteries have been fully charged. In some instances, the green LED may stay on after the charger has been unplugged from the wall outlet. Although users may perceive this as a charger malfunction, it is a normal condition. The green LED goes off when the batteries reach 26 VDC, which may take a few minutes.

Can I use a different charger?

For the safest, most efficient, and balanced charging of your Celebrity's batteries, we prefer and highly recommend the simultaneous charging of both batteries by use of the onboard battery charger.

How often must I charge the batteries?

Two major factors must be considered when deciding how often to charge your Celebrity's batteries:

- All day scooter use on a daily basis.
- Infrequent or sporadic scooter use.

With these considerations in mind, you can determine just how often and for how long you should charge your Celebrity's batteries. We designed the onboard charger so that it will not overcharge your scooter's batteries (do not charge them for more than 24 consecutive hours). However, you may encounter some problems if you do not charge your batteries often enough or if you do not charge them on a regular basis. Follow the five guidelines below to provide safe and reliable battery operation and charging.

- If you use your Celebrity daily, charge its batteries as soon as you finish using it for the day. Your Celebrity will be ready each morning to give you a "full day" of service. We recommend that you charge your Celebrity's batteries for 8 to 14 hours after daily use.
- If you use your Celebrity once a week or less, charge its batteries at least once a week for 12 to 14 hours at a time.
- Keep your Celebrity's batteries fully charged.
- Avoid deeply discharging your Celebrity's batteries.
- Do not charge your Celebrity's batteries for more than 24 consecutive hours.

How can I get maximum range or distance per charge?

Rarely will you have ideal driving conditions: smooth, flat, hard driving surfaces with no wind or curves. You will often face hills, sidewalk cracks, uneven and loosely packed surfaces, curves, and wind. All of these driving conditions affect the distance or running time per battery charge. The following are a few suggestions for obtaining the maximum range per battery charge.

VI. BATTERIES AND CHARGING

- Always fully charge your Celebrity's batteries prior to your daily use.
- Maintain 30 psi (pounds per square inch) in all of your Celebrity's tires.
- Plan your route ahead to avoid as many hills, cracked, broken, or soft surfaces as possible.
- Limit your baggage weight to essential items.
- Try to maintain an even speed while your Celebrity is in motion.
- Avoid stop-and-go driving.

What type and size of battery should I use?



WARNING! Corrosive chemicals are contained in batteries. Use only AGM or Gel-Cell batteries to reduce the risk of leakage or explosive conditions.

We recommend deep-cycle batteries that are sealed and maintenance free. Both sealed lead acid and Gel Cell are deep-cycle batteries that are similar in performance in your Celebrity. Do not use wet-cell batteries, which have removable caps.

NOTE: Sealed batteries are not serviceable. Do not remove the caps.

Use these specifications to reorder deep-cycle batteries:

Type: Deep-cycle (AGM or Gel-Cell)
Size: U-1
Voltage: 12 volts each
Amperage: 32 AH (amp hours)

To change a battery in your Celebrity:



WARNING! Battery posts, terminals, and related accessories contain lead and lead compounds. Wash hands after handling.

1. Remove the seat and the rear shroud. See IX. "Disassembly and Assembly."
2. Disconnect the battery cables from the electronic controller.
3. Disconnect the battery cables from the battery terminals.
4. Remove the old battery.
5. Place a new battery in the battery well.
6. Connect the red battery cable to the positive (+) battery terminal.
7. Connect the black battery cable to the negative (-) battery terminal.
8. Reconnect the battery cables to the electronic controller.
9. Reinstall the rear shroud and the seat.

Why do my new batteries seem weak?

Deep-cycle batteries employ a different chemical technology than is used in car batteries, nickel-cadmium batteries (nicads), or in other common battery types. Deep-cycle batteries are specifically designed to provide power, drain down their charge, and then accept a relatively quick recharge.

We work closely with our battery manufacturer to provide batteries that best suit your Celebrity's specific electrical demands. Fresh batteries arrive daily at Pride and are shipped fully charged to our customers. During shipping, the batteries may encounter temperature extremes that may influence their initial performance.

VI. BATTERIES AND CHARGING

Heat diminishes the charge on the battery; cold slows the available power and extends the time needed to recharge the battery. It may take a few days for the temperature of your Celebrity's batteries to stabilize and adjust to their new room or ambient temperature.

More importantly, it takes a few charging cycles (a partial drain followed by a full recharge) to establish the critical chemical balance that is essential to a deep-cycle battery's peak performance and long life.

Please follow these steps to properly break in your Celebrity's new batteries for maximum efficiency and service life.

1. Fully recharge any new battery prior to its initial use. This charging cycle brings the battery up to about 88% of its peak performance level.
2. Operate your new Celebrity in familiar and safe areas. Drive slowly at first, and do not travel too far from your home or familiar surroundings until you have become accustomed to your Celebrity's controls and have properly broken in your scooter's batteries.
3. Fully recharge the batteries. They should now be at over 90% of their peak performance level.
4. Operate your Celebrity again.
5. Fully recharge the batteries again.
6. After four or five charging cycles, the batteries are able to receive a charge of 100% of their peak performance level and are able to last for an extended period of time.

How can I ensure maximum battery life?

Fully charged deep-cycle batteries provide reliable performance and extended battery service life. Keep your Celebrity's batteries fully charged whenever possible. Batteries that are deeply discharged, infrequently charged, or stored without a full charge may be permanently damaged, causing unreliable performance and limited service life.

How should I store my Celebrity and its batteries?

See XI. "Care and Maintenance."

What about public transportation?

If you intend to use public transportation while using your scooter, you must contact in advance the transportation Provider to determine their specific requirements.

VII. OPERATION

BEFORE GETTING ONTO YOUR SCOOTER

- Have you fully charged the batteries? See VI. “Batteries and Charging.”
- Is the manual freewheel lever in the drive (down) position? Never leave the manual freewheel lever pulled up unless you are manually pushing your scooter.

GETTING ONTO YOUR SCOOTER

1. Make certain that the key is removed from the key switch.



WARNING! Never attempt to board or exit your scooter without first removing the key from the key switch. This will prevent the scooter from moving if accidental throttle control lever contact is made.

2. Stand at the side of your scooter.
3. Disengage the seat lock lever and rotate the seat until it is facing you.
4. Make certain that the seat is locked securely in position.
5. Position yourself comfortably and securely in the seat.
6. Disengage the seat lock lever and rotate the seat until you are facing forward.
7. Make certain that the seat is locked securely in position.
8. Make certain that your feet are safely on the floorboard.

PRE-RIDE ADJUSTMENTS AND CHECKS

- Is the seat at the proper height? See VIII. “Comfort Adjustments.”
- Is the seat locked securely in place?
- Is the tiller at a comfortable setting and locked securely in place? See VIII. “Comfort Adjustments.”
- Is the key fully inserted into the key switch? See V. “Your Celebrity.”
- Does the scooter’s horn work properly?
- Is your proposed path clear of people, pets, and obstacles?
- Have you planned your route to avoid adverse terrain and as many inclines as possible?

OPERATING YOUR SCOOTER

Keep both hands on the tiller and your feet on the floorboard at all times while operating your scooter. This driving position gives you the most control over your vehicle.

- Set the speed adjustment dial to your desired speed.
- Press your thumb against the appropriate throttle control lever.
- The electromechanical disc park brake automatically disengages and the scooter accelerates smoothly to the speed you preselected with the speed adjustment dial.
- Pull on the left handgrip to steer your scooter to the left.
- Pull on the right handgrip to steer your scooter to the right.
- Move the tiller to the center position to drive straight ahead.
- To stop, slowly release the throttle control lever.. The electronic brakes will automatically engage when your scooter comes to a stop.

NOTE: Your scooter’s reverse speed is slower than that of the forward speed you preset with the speed adjustment dial.

VII. OPERATION

GETTING OFF OF YOUR SCOOTER

1. Bring your scooter to a complete stop.
2. **Remove the key from the key switch.**
3. Disengage the seat lock lever and rotate the seat until you are facing toward the side of your scooter.
4. Make certain that the seat is locked securely in position.
5. Carefully and safely get out of the seat and stand to the side of your scooter.
6. You can leave the seat facing to the side to facilitate boarding your scooter next time.

POWER DOWN TIMER FEATURE

Your scooter is equipped with an energy saving auto power down timer feature designed to preserve your scooter's battery life. If you mistakenly leave the key in the key switch and in the "on" position but do not use your scooter for approximately 20 minutes, the scooter's controller shuts down automatically. Although the controller is shut down, power will still be supplied to the scooter's lighting system.

If the power down timer feature takes effect, perform the following steps to resume normal operation.

1. Remove the key from the key switch.
2. Reinsert the key and power up your scooter.

VIII. COMFORT ADJUSTMENTS

TILLER ANGLE ADJUSTMENT



WARNING! Remove the key before adjusting the tiller or seat. Never attempt to adjust the tiller or seat while the scooter is in motion.

You can adjust the tiller to any number of positions between the forward stop and the scooter deck.

1. Pull up on the tiller adjustment lever. See figure 12.
2. Move the tiller to a comfortable position.
3. Release the tiller adjustment lever. The tiller remains in that position.

NOTE: In order to lower the tiller to the scooter deck, you must first remove the seat and both batteries. See IX. “Disassembly and Assembly.”

SEAT HEIGHT ADJUSTMENT

The seat can be repositioned to one of five different heights.

1. Remove the seat from your Celebrity. See IX. “Disassembly and Assembly.”
2. Use the attached ring to pull and remove the ball detent pin from the seat post tower. See figure 13.
3. Raise or lower the seat pedestal to the desired seat height.
4. Hold the seat pedestal at that height and match up the holes in the seat pedestal and in the seat post tower.
5. Fully insert the ball detent pin.
6. Replace the seat.

FRONT-TO-BACK SEAT ADJUSTMENT

The Celebrity is equipped with a sliding seat that is operated like an automobile seat. You can reposition the Celebrity’s seat forward or rearward.

1. Pull out the front-to-back seat release lever. See figure 14.
2. Move the seat forward or rearward.
3. Release the front-to-back seat lever.

SEAT ROTATION

The seat lock lever locks the seat in one of four positions.

1. Push down on the seat lock lever to unlock the seat. See figure 14.
2. Rotate the seat to the desired position.
3. Release the seat lock lever to lock the seat securely in place.



Figure 12. Tiller Adjustment



Figure 13. Seat Height Adjustment

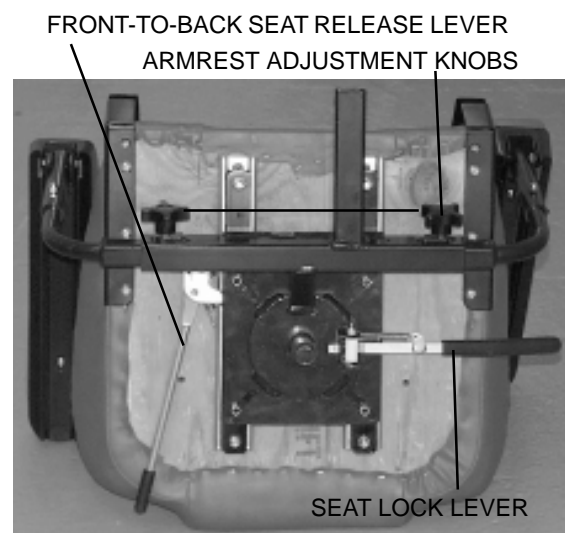

Figure 14. Seat Adjustments

VIII. COMFORT ADJUSTMENTS

ARMREST HEIGHT ADJUSTMENT

You will need the following tools to adjust the height of the armrests:

• 5/32" Hex Key • 1/8" Hex Key • 7/16" Wrench

1. Loosen the setscrew on the side of the height adjustment tube with the 1/8" hex key.
2. Loosen and remove the acorn nut and screw holding the height adjustment tube in place.
3. Raise or lower the height adjustment tube to the desired height.
4. Align the holes in the adjustment tube with the holes in the armrest upright.
5. Insert the screw through the holes in both the height adjustment tube and the armrest upright.
6. Install and tighten the acorn nut.
7. Tighten the setscrew on the side of the height adjustment tube.
8. Repeat for the other armrest.

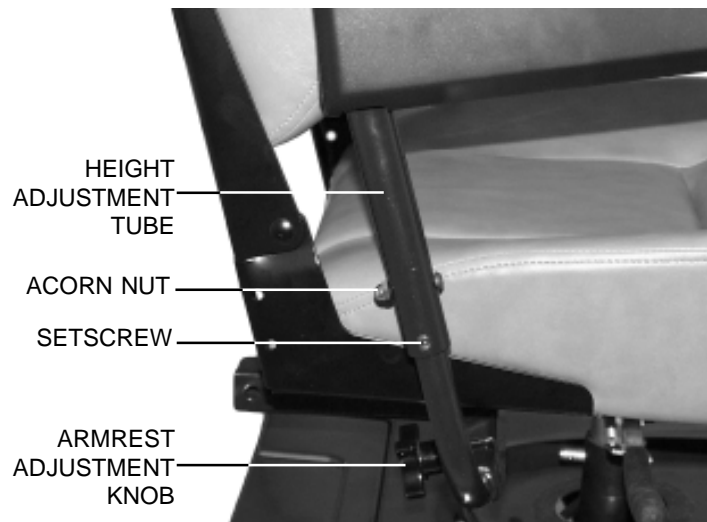

Figure 15. Armrest Height Adjustment

ARMREST WIDTH ADJUSTMENT

The armrest width of your Celebrity can be adjusted inward or outward.

1. Loosen the armrest adjustment knobs at the back of the seat frame. See figure 14 and 15.
2. Slide the armrests in or out to the desired width.
3. Tighten the armrest adjustment knobs. The armrests can also be lifted upward to allow getting on and off of your Celebrity easier.

SEAT ACTUATOR



Figure 16. Power Seat Actuator (Optional)

POWER SEAT (OPTIONAL)

Your Celebrity may be equipped with a power seat actuator which raises and lowers the seat automatically. See figure 16.

WARNING! The power seat is intended for operation only while your scooter is stationary and on a level surface. Its purpose is to aid you in reaching objects.



Strict adherence to the following safety rules is vital to your safety:

- **Do not attempt to raise or lower the seat while in motion!**
- **Operate the power seat only on level ground.**
- **Do not operate your scooter with the power seat elevated.**
- **It is recommended that the scooter be driven only with the seat in the lowest position.**

Raising and lowering the power seat when traveling or when on an incline could cause the scooter to tip over, resulting in serious injury and/or scooter damage. Keep the power seat in its lowest position when traveling or when on an incline.

IX. DISASSEMBLY AND ASSEMBLY

No tools are required to disassemble or assemble your Celebrity. Always disassemble or assemble your Celebrity on a level, dry surface with sufficient room for you to work and move around your scooter. Keep in mind that the disassembled sections of the Celebrity takes up more floor space than the assembled Celebrity.

DISASSEMBLY



WARNING! Lifting weight beyond your physical capability may result in personal injury. Ask for assistance when necessary while disassembling or assembling your scooter.

You can disassemble the Celebrity into six pieces: the seat, the front frame, the rear frame, the rear shroud, and the batteries. You can also remove the utility tray to lighten the weight of the rear section if necessary. Place the scooter in an area where you have sufficient clearance to move the parts around. You need about four or five feet in all directions. You may need assistance to lift some of the scooter's components. See IV. "Specifications" for individual component weights.

1. Place the freewheel lever in the drive (down) position.
2. Unplug the charger, coil the cord and store it in the rear compartment.
3. Push down on the seat lock lever to unlock the seat and lift the seat up and off of the Celebrity. See figure 17.
4. Gently lift the rear shroud off of the Celebrity. See figure 18.
5. Unplug the rear light harness (if so equipped). See figure 19.
6. Unplug the large white front-to-rear harness that attaches the front control console harness to the utility tray. See figure 20.
7. Disconnect the motor harness. See figure 21.
8. Unplug both 2-pin battery harnesses and lift both batteries off of the Celebrity. See figures 22 and 23.
9. If removing the utility tray, unplug the 6-pin motor harness. The utility tray is held place with reusable fasteners, to remove it, gently pull the tray straight up and off the scooter.



CAUTION! Failure to unplug both battery harnesses and the control console assembly harness prior to disassembly could result in permanent damage to the scooter.

10. Grab the handle grip on the tiller, pull upward on the release lever and gently lower the tiller down to the center of the Celebrity chassis until it is fully lowered.
11. Remove ball detent pins and lift the locking levers. See figures 24 and 25.
12. Lift up on the front section to separate it from the rear section. See figure 26.



Figure 17. Seat Removal



Figure 18. Shroud Removal

IX. DISASSEMBLY AND ASSEMBLY



Figure 19. Disconnecting The Lighting Harness



Figure 20. Disconnecting The Front-to- Rear Harness



Figure 21. Disconnecting The Motor Harness



Figure 22. Disconnecting The 2-pin Battery Harness



Figure 23. Battery Removal



Figure 24. Remove Ball Detent Pins With Rings



Figure 25. Lift Up Frame Lock Lever To Unlock



Figure 26. Separating The Frame

IX. DISASSEMBLY AND ASSEMBLY

ASSEMBLY

1. Place the freewheel lever in the drive (down) position.
2. Position the front and rear sections next to each other.
3. Tilt the rear end to a horizontal position, insert the longer tube of the front end into the rear section first, and make sure that the locking cam levers are vertically positioned and the locking pins are removed.
4. Slide the two sections of the unit together until the front half reaches its insertion limit.
5. Secure the front and rear sections with ball detent pins.
6. Push the frame lock levers back to their locked (downward) position.
7. Plug the large 9-pin white plastic harness from the front section of the Celebrity into the mating plug found on the control assembly cover on the utility tray at the rear of the Celebrity. The two orange dots present on both plugs should be adjacent to each other and enable quick plug mating.
8. Put the batteries in place and plug the 2-pin battery harnesses into the adjoining harnesses that are also located on the control assembly.
9. If the utility tray has been removed, when reinstalling it, be sure the tray is firmly pressed down on the reusable fasteners that holds it to the scooter, then reconnect the 6-pin motor harness.
10. Gently place the rear shroud over the seat pedestal.
11. Connect the rear light harness (if so equipped).
12. Slide the shroud down in place. Make sure that the rear plastic shroud does not make any contact with the rear wheels.
13. Carefully lift the seat and slide the small seat post (on the seat bottom) into the seat pedestal.
14. Rotate the seat until it locks into place.

X. OPTIONAL ACCESSORIES

For information concerning these accessories, contact your authorized Pride Provider.



• Single Crutch Holder



• Double Crutch Holder



• Oxygen Tank Holder



• Walker Holder



• Forearm Crutch Holder



• Rear Bumper



• Rear Basket



• Front Basket

XI. BASIC TROUBLESHOOTING

Any electromechanical device occasionally requires some troubleshooting. However, most of the problems that may arise can usually be solved with a bit of thought and common sense. Many of these problems occur because the batteries are not fully charged, or because the batteries are worn down and can no longer hold a charge.

What if all the systems on my Celebrity seem to be “dead”?

- Make certain that the key is fully inserted in the key switch.
- Check that the batteries are fully charged. See VI. “Batteries and Charging.”
- Push in the reset button to reset the main circuit breaker. See V. “Your Celebrity.”
- Make certain that both battery harnesses are firmly connected to the electronic controller assembly and to the battery terminals. See IX. “Disassembly and Assembly.”
- Make sure that the front-to-rear harness connector is firmly connected. See IX. “Disassembly and Assembly.”

What if the motor runs but my Celebrity does not move?

- Your Celebrity was probably left in manual freewheel mode.
- When the freewheel lever is pulled up, the brakes are disengaged and all power to the transaxle is cut.
- Push down the freewheel lever to restore normal operation to your Celebrity. See V. “Your Celebrity.”

What if the main circuit breaker repeatedly trips? See V. “Your Celebrity.”

- Charge the Celebrity’s batteries more frequently. See VI. “Batteries and Charging.”
- If the problem continues, have both of your Celebrity’s batteries load tested by your authorized Pride Mobility Products Corporation Provider.
- Or, battery load testers are available at most automotive parts stores.
 - Follow the directions supplied with the load tester.
 - See VI. “Batteries and Charging” or Section IV. “Specifications” for information about your Celebrity’s battery type.

What if the battery condition meter dips way down and the motor surges or hesitates when I press my Celebrity’s throttle control lever? See V. “Your Celebrity.”

- Fully charge your Celebrity’s batteries. See VI. “Batteries and Charging.”
- Have your authorized Pride Provider load test each battery.
- Or, see the previous troubleshooting question for load testing the batteries yourself.

If you experience any problems with your Celebrity that you are not able to solve, immediately contact your authorized Pride Provider for information, maintenance, and service.

XII. CARE AND MAINTENANCE

Your scooter requires a minimal amount of care and maintenance. If you do not feel confident in your ability to perform the maintenance listed below, you may schedule inspection and maintenance at your authorized Pride Provider. The following areas require periodic inspection and/or care and maintenance.

TIRE PRESSURE

- If equipped with pneumatic tires, always maintain a proper **30-35 psi** tire pressure.



WARNING! It is important that 30-35 psi tire pressure be maintained in pneumatic tires at all times. Do not underinflate or overinflate your tires. Low pressure may result in loss of control, and overinflated tires may burst. Failure to maintain 30-35 psi tire pressure in pneumatic tires at all times may result in tire and/or wheel failure, causing serious personal injury and/or damage to your scooter.

- Regularly inspect your scooter's tires for signs of wear.

EXTERIOR SURFACES

Bumpers, tires, trim, and the tiller boot can benefit from an occasional application of rubber or vinyl conditioner.



WARNING! Do not use a rubber or vinyl conditioner on the scooter's vinyl seat, floorboard, or tire tread. They will become dangerously slippery and result in personal injury and/or damage to your scooter.

BATTERY TERMINAL CONNECTIONS

- Make certain that the terminal connections remain tight and uncorroded.
- The batteries must sit flat in the battery wells.
- The battery terminals should face the rear of the scooter.

WIRING HARNESSES

- Regularly check all wiring connections.
- Regularly check all wiring insulation, including the charger power cord, for wear or damage.
- Have your authorized Pride Provider repair or replace any damaged connector, connection, or insulation that you find before using your scooter again.

ABS PLASTIC SHROUDS

- The front tiller shroud, front shroud, and the rear shroud are formed from durable ABS plastic and are coated with an advanced formula urethane paint.
- A light application of car wax will help the shrouds retain their high gloss.

AXLE BEARINGS AND THE MOTOR/TRANSAXLE ASSEMBLY

These items are all prelubricated, sealed, and require no subsequent lubrication.

MOTOR BRUSHES

The motor brushes are housed inside of the motor transaxle/assembly. They should be inspected periodically for wear by your authorized Pride Provider.

XII. CARE AND MAINTENANCE

CONSOLE, CHARGER, AND REAR ELECTRONICS

- Keep these areas free of moisture.
- Allow these areas to dry thoroughly if they have been exposed to moisture before operating your scooter again.

STORING YOUR SCOOTER

If you plan on not using your scooter for an extended period of time, it is best to:

- Fully charge its batteries prior to storage.
- Disconnect the batteries from the scooter.
- Store your scooter in a warm, dry environment.
- Avoid storing your scooter where it will be exposed to temperature extremes.



WARNING! Always protect batteries from freezing temperatures and never charge a frozen battery. This damages the battery and can cause personal injury.

For prolonged storage, you may wish to place several boards under the frame of your scooter to raise it off of the ground. This takes the weight off the tires and reduces the possibility of flat spots developing on the areas of the tires contacting the ground.

XIII. WARRANTY

THREE-YEAR LIMITED WARRANTY

Three years on all structural frame components; including platform, fork, seat post, and frame.

Three-year prorata drive train warranty; including transaxle, motor, and brake.

- First year: 100% replacement of parts cost
- Second year: 67% replacement of parts cost
- Third year: 50% replacement of parts cost

THREE-YEAR WARRANTY EXCEPTIONS

Transaxle: In cases where there is an increase in the operational noise level, the warranty does not apply. (The increase in operational noise level usually occurs due to abusive and excessive strain on the scooter.)

Motor brake: Three-year warranty for the electrical function of the motor brake. Brake pads are a wear item and are not warranted.

ONE-YEAR LIMITED WARRANTY

For one (1) year from the date of purchase, Pride will repair or replace at our option to the original purchaser, free of charge, any part or electronic component found upon examination by an authorized representative of Pride to be defective in material and/or workmanship.

The battery is warranted by the battery manufacturer (six-month limited warranty). The battery is not warranted by Pride.

Warranty service can be performed by Pride or by an authorized Pride Provider. Do not return faulty parts to Pride without prior consent. All transportation costs and shipping damage incurred while submitting parts for repair or replacement are the responsibility of the original purchaser.

WARRANTY EXCLUSIONS

- ABS plastic shrouds and footrest covers (wear items and not warranted)
- Batteries (the battery manufacturer provides a 6 month limited warranty)
- Tires and tire tubes (wear items and not warranted)
- Upholstery and seating (wear items and not warranted)
- Repairs and/or modifications made to any part of the scooter without specific and prior consent from Pride
- Circumstances beyond the control of Pride
- Damage caused by: battery fluid spillage or leakage, abuse, misuse, accident, or negligence, improper operation, maintenance, or storage, commercial use or use other than normal
- Labor, service calls, shipping, and other charges incurred for repair of the product

There is no other express warranty.

Implied warranties, including those of merchantability and fitness for a particular purpose, are limited to one (1) year from the date of original purchase and to the extent permitted by law. Any and all implied warranties are excluded. This is the exclusive remedy. Liabilities for consequential damages under any and all warranties are excluded.

Some states do not allow limitations on how long an implied warranty lasts or do not allow the exclusion of limitation of incidental or consequential damages. So, the above limitation or exclusion may not apply to you.

NOTES



Pride
Mobility Products Corp.

182 Susquehanna Ave.
Exeter, PA 18643
1-800-800-8586

www.pridemobility.com

Free Manuals Download Website

<http://myh66.com>

<http://usermanuals.us>

<http://www.somanuals.com>

<http://www.4manuals.cc>

<http://www.manual-lib.com>

<http://www.404manual.com>

<http://www.luxmanual.com>

<http://aubethermostatmanual.com>

Golf course search by state

<http://golfingnear.com>

Email search by domain

<http://emailbydomain.com>

Auto manuals search

<http://auto.somanuals.com>

TV manuals search

<http://tv.somanuals.com>