

owner's manual

ple420p

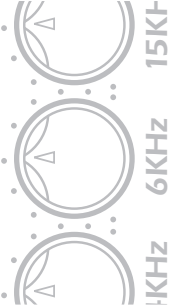

in-dash 4 band parametric equalizer



PYLE®

www.pyleaudio.com

congratulations . . .

for choosing Pyle Audio, and congratulations on joining a select group of dedicated enthusiasts committed to the very best in mobile sound performance and dependability.

You are now the proud owner of one of the world's most sophisticated electronics components. This Pyle product is the result of an extensive engineering program with the sole purpose of creating the finest mobile audio experience imaginable. We're confident that this product will provide you with many years of outstanding musical entertainment.

table of contents

Ple420p



i	congratulations
1	table of contents
2	general features
3	specifications
4-5	features and controls
6	mounting and installation
7	electrical connections
8-9	system wiring
10	precautions and troubleshooting

PYLE®

general features

ple420p



4 band parametric controls

pre-amp DVD & AUX input

via RCA jacks

output volume control

input gain adjustments

ple420p

subwoofer output

3.5mm DVD input jack

blue light illumination

frequency gain control

rotary fader

rotary band control

6 channels RCA outputs

remote power on/off

specifications

ple420p

ple420p

4 band parametric	SUB 150Hz, LOW 400Hz, MID 2.5KHz, HI 15KHz
boost/cut	18dB
frequency response	15 Hz - 30 KHz (+/- 1 dB)
input level (for 400mV output)	200 mV
total harmonic distortion (THD) (at 400mV output)	< 0.03%
output impedance	10K Ohms
signal-to-noise ratio (S/N)	90 dB
separation	50 dB
current drain	200 mA
power supply voltage	12V DC Neg. Ground
dimensions (W x H x L)	
mm	178 x 28 x 105
inches	7 x 1.1 x 4.1

features and controls

ple420p

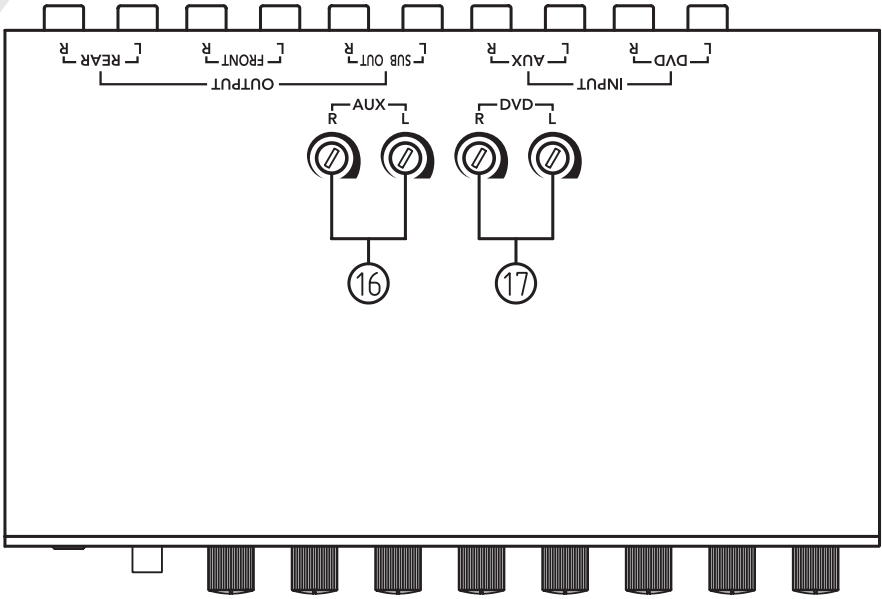

front

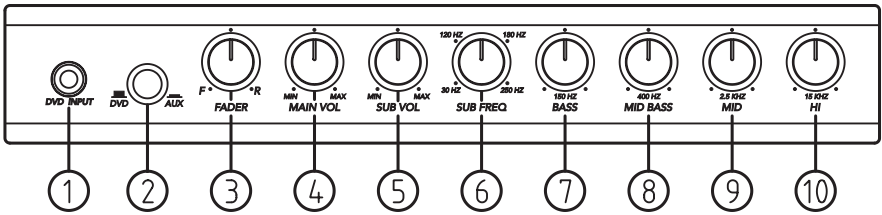

rear

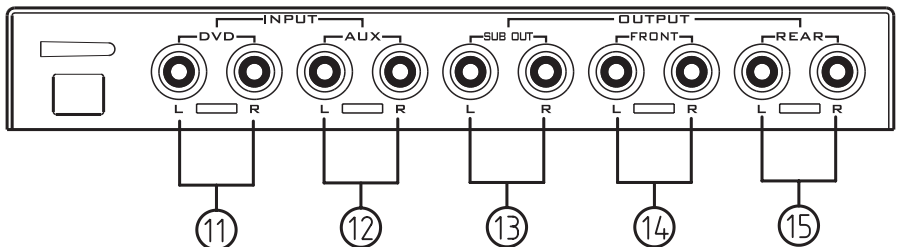

features

1. 3.5mm DVD input jack

Connects to the DVD source with 3.5mm plug cable.

2. DVD & AUX input switch

to select the AUX or DVD inputs.

3. fader control

- in a 2 Amplifier, 4 Speaker system, rotating the knob to the FRONT side increases the level of the front speakers; rotating to the REAR side increase level of the rear speakers. At mid position, both sets of speakers are at maximum level.

- in a 2 Speaker system, the fader control should be rotated to the position which provides highest levels for both sets of speakers.

4. volume control

allows adjustment of sound level for particular program material or source.

5. subwoofer output volume

this control adjusts output level of subwoofer RCA jack.

6. subwoofer frequency control

lets you adjust the subwoofer crossover frequency point from 30-250 Hz.

7-10. 4 band parametric equalizer controls

this four-band equalizer gives you to control over the output levels at various frequency.

11-12. DVD and AUX inputs

RCA cables are used to connect your car stereo head unit, DVD player, or other source to either the line or AUX inputs.

13-15. subwoofer/rear/front channel outputs

RCA cables are used to connect the subwoofer channel outputs to the subwoofer channel amplifier inputs, the rear channel outputs to the rear channel amplifier inputs, and the front channel outputs to the front channel amplifier inputs.

16-17. DVD/AUX input gain adjustments

allows you to adjust the left and right channel input sensitivity to match the output level from your DVD or auxiliary source.

power connections

connect to power source as follows:

+12V: Connect a red wire of at least 12 gauge to the car battery or other power source.

GROUND: Connect a black wire of at least 12 gauge to car chassis for ground connection

REMOTE: Connect an orange wire to remote activating (12V DC) wire of car stereo or other head unit.

mounting and installation

ple420p

mounting

Please take the time to install your new Pyle Signal Processor securely, according to this diagram, using the hardware provided.

This Half-DIN size unit can also be installed in the dash adjacent to the head unit, provided that there is a slot available.

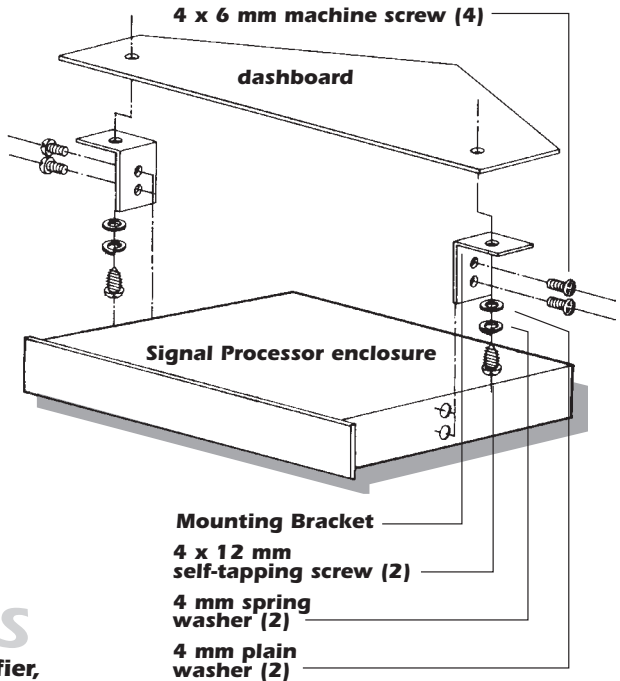

wiring tips

When making electrical connections to your amplifier, please observe the following:

Connect 12V DC from a constant battery source to a +12V slip-on spade terminal and install a one (1) amp fuse in line.

Connect the signal processor's GROUND to a good chassis ground, near where the unit is mounted, or to the case of the head unit.

Connect the signal processor's REMOTE TURN-ON lead to the remote turn-on lead out of the head unit, and install a 1/2 amp fuse in line. (A relay should be used if turning on more than one component, such as EQs, crossovers or amplifiers.)

Connect stereo RCA cables from the head's left and right front outputs to the left and right inputs of the signal processor.

Connect stereo RCA cables from the left and right outputs, (and low, mid and high outputs if applicable), of the signal processor to the left and right inputs of your amplifier(s) or additional signal processor(s).

Turn the unit on, and adjust the input gain on the signal processor to match the output of the head unit (1/2, or at center position, is about 1 V). Be careful not to overdrive the input of your amplifier(s) or signal processor(s).

Adjust each of the crossover or equalizer controls to achieve the desired sound characteristics.

electrical connections

ple420p

rear

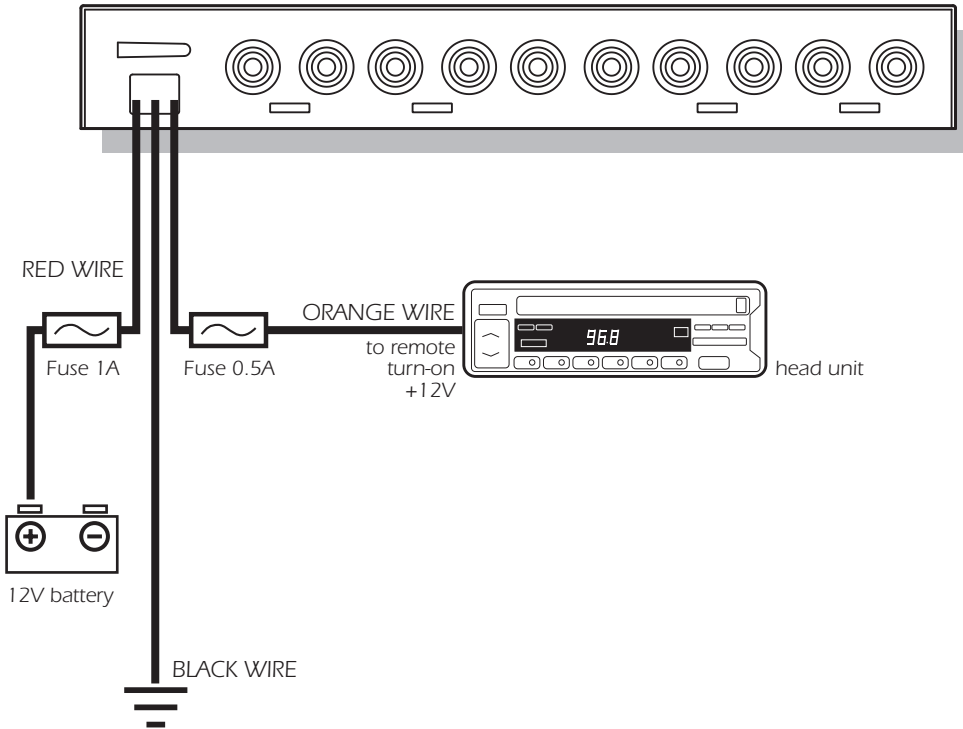

system wiring

basic system application using
front, rear, and subwoofer amps

ple420p

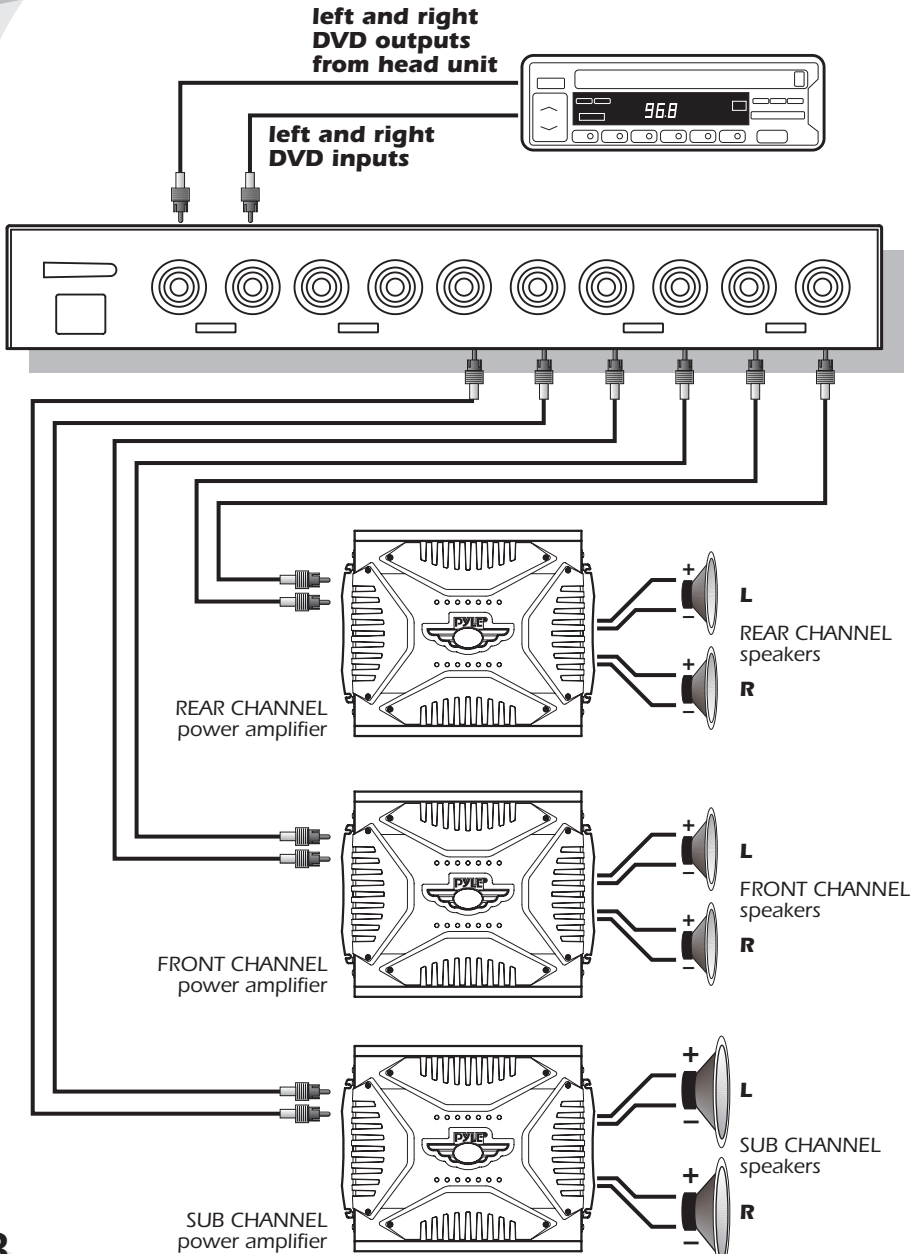

system wiring

basic system application using
a **4 channel amp** and **subwoofer amp**

ple420p

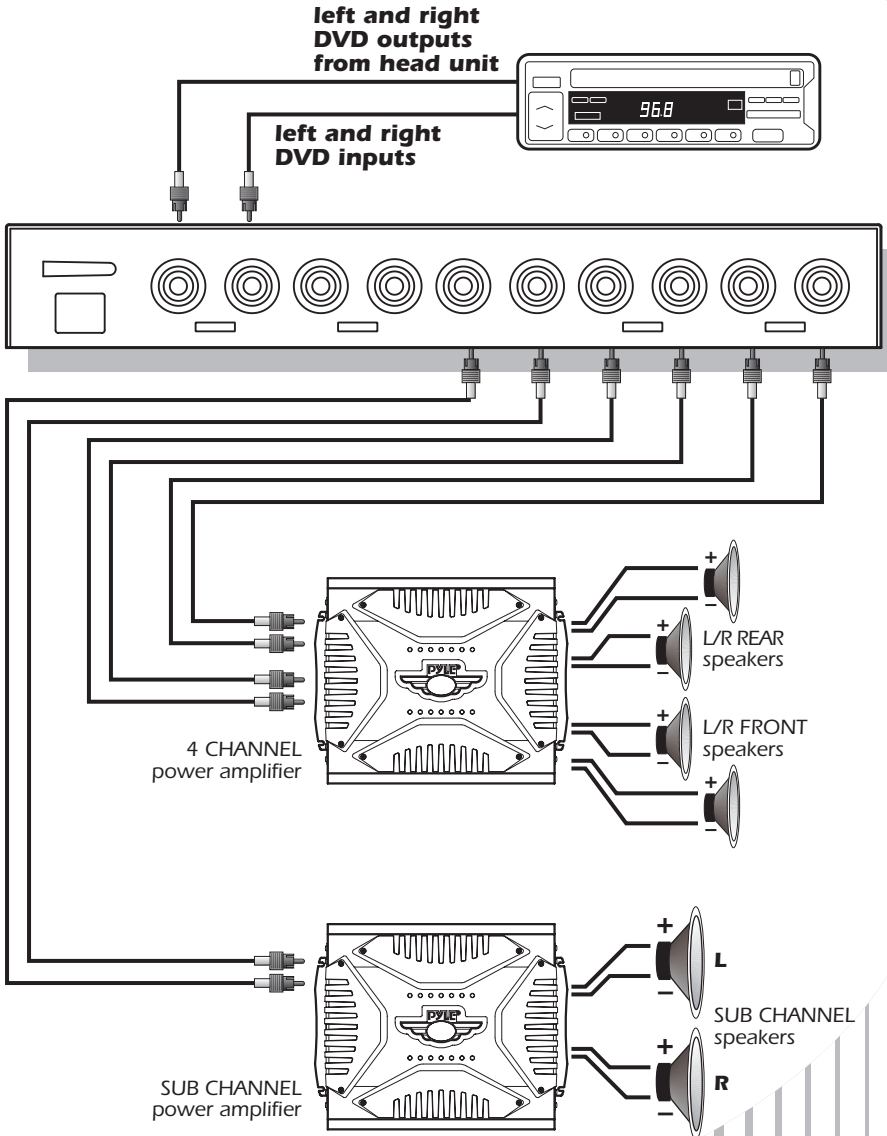

PYLE[®]

precautions

ple420p

- Never drive with the volume raised so high you cannot hear what is occurring in traffic around you.
- Be aware that repeated exposure to excessive volume levels can permanently damage your hearing!
- Keep all electronics away from moisture, dust, extreme heat or extreme vibrations.
- Pyle Audio products are capable of sound pressure levels in excess of 150 dB. Continuous exposure to sound pressure levels over 100 dB may cause permanent loss of hearing. Use common sense and PRACTICE SAFE SOUND.

troubleshooting

If you experience...

Signal Processor does not turn on. Check that:

- Remote Turn-On wire has 12V.
- 12V wire has 12V.
- Ground wire is properly connected.

Level of sound is low. Check that:

- Wiring is not loose or cables misconnected/disconnected.
- RCA cables are not faulty.

Background noise is too high. Check that:

- Wiring is not loose or cables misconnected/disconnected.
- RCA cables are not faulty.

notes

limited warranty policy

All Pyle products are carefully constructed and thoroughly tested before shipment. Products purchased in the USA are warranted to be free of defects in material and workmanship for two (2) years from the date of purchase. This warranty is limited to the original retail purchaser.

Should the product fail due to factory defects in material or workmanship, your unit will be repaired or replaced at the sole discretion of Pyle.

To obtain warranty service you must first call our Consumer Return Hotline number at (718) 236-6948 to obtain a Return Authorization number. This R.A.# must appear on the outside of your package and on all paperwork relating to your return.

When returning a product to us for warranty service it must be carefully packed and shipped prepaid to:

R.A.#
Pyle Service Center
1600 63rd Street
Brooklyn, NY 11204

You must also include the following items:

- A copy of your sales receipt or other proof of purchase
- A brief letter indicating the problem you are experiencing
- include in your letter your return address, daytime phone number, and R.A. number
- also include a check or money order for \$12.00 for return shipping, handling, and insurance, or provide your Visa/MC number with expiration date.

Our obligation under this warranty is limited to the repair or replacement of the defective unit when it is returned to us prepaid. This warranty will be considered void if the unit was tampered with, improperly serviced, or subject to misuse, neglect, or accidental damage.

Free Manuals Download Website

<http://myh66.com>

<http://usermanuals.us>

<http://www.somanuals.com>

<http://www.4manuals.cc>

<http://www.manual-lib.com>

<http://www.404manual.com>

<http://www.luxmanual.com>

<http://aubethermostatmanual.com>

Golf course search by state

<http://golfingnear.com>

Email search by domain

<http://emailbydomain.com>

Auto manuals search

<http://auto.somanuals.com>

TV manuals search

<http://tv.somanuals.com>