



QC40198 User Manual

19" LCD Observation System



Rev 3/30/2010

Please contact a Q-See support representative first regarding any additional information you need help with regarding product features, specification or assistance with setup.

Please contact us using the following methods with questions about your Q-See product.

Q-See Products

8015 E. Crystal Dr.
Anaheim, CA 92807



Email:

Customer Service
cs@dpsi-usa.com

Technical Support
ts@dpsi-usa.com

Online live web chat visit:
www.q-see.com



Telephone:

Customer Service
1.877.998.3440 x 538

Technical Support
1.877.998.3440 x 539

Fax:
1.714.998.3509

1. Electrical Safety

All installation and operation should conform to your local electrical safety codes.

We assume no liability or responsibility for any fires or electrical shock caused by improper handling or installation.

2. Transportation Security

Avoid heavy stress, violent vibrations or contact with water during transportation, storage and installation of this system.

3. Installation

Keep upright. Handle with care.

Do not provide power to the combo DVR prior to completing installation.

Do not place objects on the combo DVR.

4. Qualified Service Technicians

Any examination and repair work should be done only by a qualified service engineer.

We are not liable for any problems caused by unauthorized modifications or attempted repairs.

5. Environment

This product works in a temperature range of 32°F to 104°F (0°C -40°C).

This combo DVR should be installed in a cool, dry place away from direct sunlight and flammable or explosive substances, etc.

6. Accessories

Make sure to only use accessories recommended by Q-See.

Before installation, check the package to verify that all the components are included.

Contact your local retailer ASAP if something is broken in your package.

7. About the LCD Screen

During installation, do not push or squeeze the LCD or its rim as this may result in LCD damage.

During operation or storage be careful to avoid contact between hard objects and the LCD screen.

Keep the LCD screen clean by using a soft cloth to remove any dirt or smudges regularly. Never use ether-based chemicals, alcohol or other chemical agents to clean your screen.



Thank You for Choosing a Q-See Product!

All of our products are backed by a conditional service warranty covering all hardware for 12 months from the date of purchase. Additionally, our products also come with a free exchange policy that covers all manufacturing defects for one month from the date of purchase. Permanent upgrading service is provided for the software.

Liability Exclusions:

Any product malfunction or abnormalities in operation or damage caused by the following reasons are not within the free service scope of our company:

- (1) Equipment damage caused by improper operation.
- (2) Improper equipment operation environment and conditions (e.g., improper power, extreme environmental temperatures, humidity, lightning and sudden surges of electricity).
- (3) Damage caused by acts of nature (e.g., earthquake, fire, etc).
- (4) Equipment damage caused by the maintenance of personnel not authorized by Q-See.
- (5) Product sold over 12 months ago.

In order to fulfill the terms of your warranty, you must complete the registration process after purchasing our product. To do this, simply fill out the User's Information Card below and fax or mail it in to us at the information listed below. You can also register the product by going to the www.q-see.com website and clicking on the Register link.

Customer Information Card

User's Name	Mr./Mrs.
Company Name	
Postal Address	
Postal code	
Phone Number	
E-mail	
Model Number of Product	
Serial Number of Product	
Purchase Date	
Distributor	

The material in this document is the intellectual property of Q-See.

No part of this manual may be reproduced, copied, translated, transmitted, or published in any form or by any means without our company's expressed written consent.

1. Our products are under continual improvement and we reserve the right to make changes without notice. No guarantee is given as to the correctness of its contents.
2. We do not accept any responsibility for any harm caused by using our product.
3. The product picture may differ from the actual product, which is only for your reference. The accessories may be different according to the region you purchased our product. For more information on specific accessories, please contact your local distributor.

Copyright Reserved

1.	<i>FEATURES AND SPECIFICATIONS</i>	1
1.1	Features	1
1.2	Specifications	3
2.	<i>CONTROLS</i>	7
2.1	Front Panel and Side Panel	7
2.2	Rear Panel	8
2.3	Remote Control	9
2.4	Mouse Control.....	11
3.	<i>INSTALLATION AND CONNECTION</i>	13
3.1	What's in the Box	13
3.2	Connection Diagram	13
3.3	Device Installation	14
3.4	Hard Drive Installation.....	15
3.5	Connecting Power Supply.....	16
3.5.1	Connecting Video Input.....	16
3.5.2	Connecting Video Output.....	16
3.6	Connecting Audio Input & Output, Bidirectional Audio.....	17
3.6.1	Audio Input.....	17
3.6.2	Audio Output	17
3.7	Alarm Input and Output Connection.....	18
3.7.1	Alarm Input and Output Details	19
3.7.2	Alarm Input Port	20
3.7.3	Alarm Output Port	20
3.8	RS232	21
3.9	RS485	21
3.10	Other Interfaces	22
4.	<i>NAVIGATION AND CONTROLS</i>	23
4.1	Login, Logout & Main Menu	23
4.1.1	Login	23
4.1.2	Main Menu	23
4.1.3	Logout	24
4.1.4	Auto Resume after Power Failure.....	24
4.2	Manual Recording.....	25
4.2.1	Live Viewing.....	25
4.2.2	Manual Record.....	25

4.3	Search & Playback.....	27
4.3.1	Search Menu.....	27
4.3.2	Playback.....	28
4.3.2.1	Playback Mode.....	28
4.3.2.2	Accurate Playback.....	28
4.3.2.3	Synchronized Playback Function when Playing Back.....	28
4.3.2.4	Digital Zoom.....	28
4.3.2.5	File Backup.....	28
4.3.2.6	Slow Playback and Fast Playback.....	28
4.3.3	Calendar.....	29
4.4	Schedule.....	29
4.4.1	Schedule Menu.....	29
4.4.2	Quick Setup.....	30
4.4.3	Snapshot.....	30
4.4.4	Image FTP.....	32
4.5	Motion Detection.....	32
4.5.1	Go to Detect Menu.....	32
4.5.2	Motion Detect.....	32
4.5.3	Video Loss.....	35
4.5.4	Camera Masking.....	35
4.6	Alarm Setup and Alarm Activation.....	36
4.6.1	Alarm setup.....	36
4.7	Backup.....	38
4.7.1	Detect Device.....	38
4.7.2	Backup Device.....	39
4.8	PTZ Control and Color Setup.....	40
4.8.1	Cable Connection.....	40
4.8.2	PTZ Setup.....	40
4.8.2.1	Intelligent Positioning Key.....	42
4.9	Preset/ Patrol/Pattern/Scan.....	42
4.9.1	Preset Setup.....	43
4.9.2	Activate Preset.....	43
4.9.3	Patrol setup (Tour Setup).....	43
4.9.4	Activate Patrol (tour).....	44
4.9.5	Pattern Setup.....	44
4.9.6	Activate Pattern Function.....	44
4.9.7	Auto Scan Setup.....	44
4.9.8	Activate Auto Scan.....	45
4.10	Flip.....	45
5.	UNDERSTANDING OF MENU OPERATIONS AND CONTROLS.....	46
5.1	Menu Tree.....	46
5.2	Main Menu.....	47
5.3	Setting.....	47
5.3.1	General.....	48
5.3.2	Encode.....	49

5.3.3	Schedule	50
5.3.4	RS232	51
5.3.5	Network	51
5.3.5.1	Advanced Network Setup	53
5.3.6	Alarm	58
5.3.7	Detect	58
5.3.8	Pan/Tilt/Zoom	59
5.3.9	Display	59
5.3.10	Default	61
5.4	Search	62
5.5	Advanced	62
5.5.1	HDD Management	63
5.5.2	Abnormity	64
5.5.3	Alarm Output	64
5.5.4	Manual Record	65
5.5.5	Account	65
5.5.6	Auto Maintain	66
5.5.7	TV Adjust	66
5.6	Information	66
5.6.1	HDD Information	67
5.6.2	BPS	67
5.6.3	Log	68
5.6.4	Version	68
5.6.5	Online Users	69
5.7	Shutdown	69
6.	AUXILIARY MENU	70
6.1	Go to Pan/Tilt/Zoom Menu	70
6.2	Intelligent Positioning Key	71
6.3	Preset /Patrol / Pattern /Border Function	71
6.3.1	Preset Setup	72
6.3.2	Activate Preset	72
6.3.3	Patrol Setup	72
6.3.4	Activate Patrol	72
6.3.5	Pattern Setup	72
6.3.6	Activate Pattern Function	73
6.3.7	Border Setup	73
6.3.8	Activate Border Function	73
6.3.9	Flip	73
7	WEB OPERATION	74
7.1	Network Connection	74
7.1.1	Port Forwarding	74
7.1.2	Pop-Ups and ActiveX Controls	75
7.2	Login	77
7.2.1	Real-time Monitoring	79
7.2.2	PTZ	81

7.2.3	Color.....	83
7.2.4	Picture Path and Record Path	83
7.3	Configure.....	85
7.3.1	System Information	85
7.3.2	System Configuration.....	87
7.3.3	Advanced	106
7.3.4	Additional Function.....	112
7.4	Search.....	112
7.5	Alarm.....	115
7.6	About.....	117
7.7	Log out	117
7.8	Un-install Web Control	117
8.	SETUP MYQ-SEE DDNS	118
9	SMARTPHONE ACCESS.....	121
10	TROUBLESHOOTING.....	123
	APPENDIX A: HDD CAPACITY CALCULATION	128
	APPENDIX B: COMPATIBLE USB DRIVE LIST.....	129
	APPENDIX C: COMPATIBLE CD/DVD BURNER LIST.....	130
	APPENDIX D: COMPATIBLE SATA HDD LIST.....	131

1. FEATURES AND SPECIFICATIONS

This combo DVR integrates a DVR (Digital Video Recorder) and LCD screen together. It is an excellent digital monitor with a sleek appearance and innovative capabilities which are functional and reliable.

It uses an embedded Linux OS to maintain stable operation and a popular H.264 compression algorithm to produce high quality low bit stream footage that is easy to manage and efficient to transfer over the internet. It can use various functions such as record, playback, and monitoring at the same time and produces audio and video synchronization. This product has advanced technology and strong network data transmission functions.

This combo DVR utilizes a high quality LCD capable of producing rich and vivid images. Its convenient 19-inch screen enables maximized viewing capabilities. This is an ideal system that can be used in an in-home environment and a variety of business environments that require enhanced monitoring capabilities such as: super markets, convenience stores, transportation, etc.

1.1 Features

This product has the following features:

- **Smartphone Compatible**
Access live footage directly from your iPhone, or other Smartphone¹. Your DVR can also be set to email your hand held-device directly whenever specific activity occurs, such as motion detection.
- **View Your Video Feed Online with No Service Fees**
View your DVR's live or recorded video footage on any Internet accessible computer with Internet Explorer, Mozilla Firefox and Google Chrome².
- **Stay Notified with Customizable Email Alerts**
Set your system up to notify you when an event has occurred at the location you are monitoring. Notification alerts can easily be adjusted to your specifications.
- **Advanced Motion Detection Activated Recording**
Advanced motion detection settings ensure that false alarms are not triggered. The easy to use motion detect set up screen allows you to mask out certain areas which experience heavy movement in order to avoid false alarms and avoid unnecessary record triggering.
- **Multiple Backup Options³**
A built-in USB port gives you the option of backing up and transferring your video footage using a flash drive or external USB hard drive. You can also connect to an external CD/DVD writer to burn your file footage right onto a compact disc or DVD disc. Files can also be accessed from your DVR system to a remote computer location by logging on remotely.
- **Connect to a TV or PC Monitor Easily**
This system comes with a VGA out port and PC in port to allow you to connect to a TV or computer monitor for viewing purposes. The LCD is equipped to support simultaneous BNC & HDMI output.

¹ For a complete list of compatible Smartphone's, please see Section 9 "Smartphone Access"

² Internet Explorer, Mozilla Firefox and Google Chrome are registered trademarks of their respective owners and are not affiliated with Q-See.

³ For a complete list of compatible Hard Drives, USB Drives and external DVD Burners, see Appendixes B-D

● **User-Friendly LCD Control Functions**

Front panel button control allows instant booting up and system shut down at the press of a button. LCD monitor can be set to go into energy efficient stand-by mode.

● **Included Mouse and Remote Control**

In addition to front panel button controls, system can also be booted up and shut down using the included remote control or mouse. Mouse operation function supports intelligent operation by enabling copy and paste functions.

● **Storage Function**

Encrypted file format to ensure data security and avoid vicious data modification.

● **Compression Format**

Supports multiple-channel audio and video. Independent hardware decodes the audio and video signal from each channel to maintain video and audio synchronization.

● **24/7 Scheduled Recording**

Choose which days of the week and hours of the day you want to set your DVR to record or not record.

● **Multiple Playback Options and Advanced Search Functions**

Supports real-time recording on each channel independently. Search through recorded files while you are playing live footage, monitoring through a remote location using a supported internet browsing application and backing up system files. A variety of playback modes include: slow play, fast play, backward play and frame by frame play.

● **Network Monitoring**

Supports network remote real-time monitoring (available bandwidth permitting), remote record search and remote PTZ control.

● **Alarm Activation Function**

Several relay alarm outputs enable you to pair your system with an on-site alarm system.

● **Communication Ports**

- RS485 port can be used for PTZ camera control.
- RS232 port can connect to a keyboard for central control, and can also connect to PC COM to upgrade system and maintain system settings.
- Standard Ethernet port allows you to access the DVR from a network or the Internet.

● **PTZ camera control**

- Supports PTZ decoder via RS485.
- Supports a variety of protocols to allow the DVR to control the PTZ speed dome.

1.2 Specifications

Combo Digital Video Recorder		
	Main Processor	High-performance industrial embedded micro controller
	OS	Embedded LINUX
	System Resources	Multiplex operations: Multiple-channel record, multiple-channel playback and network operation simultaneously
	Interface	User-friendly graphical interface
	Input Devices	Front panel, USB mouse, remote control
	Input Method	Arabic number, English character, and extended Chinese (optional)
	Shortcut Function	Copy/paste operation, USB mouse right-key shortcut menu, double click USB mouse to switch screen
Compression Standard		
	Video Compression	H.264
	Audio Compression	G.711A
Video Monitor		
	Video Input	1-CH PC input 8-CH composite video input: (NTSC/PAL) BNC (1.0VB _{P-P} , 75Ω)
	Video Output	1-ch PAL/NTSC, BNC (1.0VP- P, 75Ω) composite video signal output. 1-ch HDMI output. Supports simultaneous TV/HDMI video output.
	Video Standard	PAL (625 line, 50f/s), NTSC (525 line, 60f/s)
	Record Speed	Real-time Mode: PAL 1f/s to 25f/s per channel and NTSC 1f/s to 30f/s per channel
	Video Partition	1/4/9 windows
	Monitor Touring	Supports monitor tour functions such as alarm, motion detection, and scheduled auto control.
	Resolution (PAL/NTSC)	PAL/NTSC Real-time monitoring : D1: 704×576/704×480 Playback : D1 704×576/704×480 (6f/s, when other channels' resolution are all CIF, the first channel can support 30f/s.) , CIF 352×288/ 352×240 , QCIF 176×144/176×120 Dual stream function. The extra stream supports QCIF 176×144/176×120.
	Image Quality	6-level image quality (Adjustable)
	Privacy mask	Support one privacy mask of user-defined size in full screen. Support up to 4 zones.
	Image Information	Channel information, time information and privacy mask zone.
	TV Adjust	Adjust TV output zone suitable to anamorphic video.
	Channel Lock	Cover secret channel with blue screen though system is encoding normally. Screen-lock function to prevent unauthorized user seeing secret video.

	Channel Information	Channel name, recording status, screen lock status, video loss status and motion detection status are shown on the bottom left of display screen.
	Color Configuration	Hue, brightness, contrast, saturation and gain setup for each channel.
Audio		
	Audio Input	4-ch 200-2000mv 10KΩ(BNC)
	Audio Output	1-ch audio output 200-3000mv 5KΩ(BNC)
	Bidirectional Audio	1-ch bidirectional talk input 200-3000mv 10KΩ (BNC) 1-ch bidirectional talk output 200-3000mv 5KΩ(BNC)
Hard Disk		
	Hard Disk	1 built-in SATA port. Support 1 HDD.
	Hard Disk Occupation	Audio : PCM 28.8MByte/h Video : 56-900MByte/h
Record and Playback		
	Recording Mode	Manual recording, motion detection recording, schedule recording and alarm recording Priority: Manual recording> alarm recording>motion detection recording>schedule recording.
	Recording Length	1 to 120 minutes single record duration (Default setup is 60 minutes)
	Playback Repeat Way	When hard disk is full, system can overwrite previous video file.
	Record Search	Various search engines such as time, type and channel.
	Playback Mode	Various fast play, slow play speeds, manual frame by frame playback and reverse play mode.
	Various File Switch Ways	Can switch to previous or next file or any file in current play list. Can switch to file on other channel of the same time. (If there is a file) Support file continuous play, when file is end system auto plays the next file in the current channel
	Multi-channel Playback	There are two playback modes: 4-ch and full-channel. In 4-ch playback mode, you can select the 1/2/3/4-ch playback according to your requirement. In full-channel mode, system can playback in full channels.
	Window Zoom	Switch between self-adaptive screen/full screen when playback
	Partial Enlargement	When in one-window full-screen playback mode, you can select any zone to activate partial enlargement function.
Backup Function		
	Backup Mode	HDD backup
		Support peripheral USB backup device. (Flash disk, portable disk, etc.)
		Support USB burner (extension function).
		Support network download and backup

Network Function		
	Network control	View monitor channel remotely.
		Device configuration through client-end and web browser
		Upgrade via client or browser to realize remote maintenance.
		View alarm information such as external alarm, motion detection and video loss via client.
		Support network PTZ lens control
		File download backup and playback
		Multiple devices share information via corresponding software such as professional surveillance software (PSS)
		Duplex transparent COM
		Network alarm input and output
		Bidirectional audio.
Motion Detection and Alarm		
	Motion Detection	Zone setup: supports 396 (PAL 22×18, NTSC 22×15) detection zones. Various sensitivity levels. Alarm can activate record or external alarm or screen message prompt.
	Video Loss	Alarm can activate external alarm or screen message prompt.
	External Alarm	Support record activation function or activate external alarm or screen message in specified period.
	Manual Alarm Control	Enable or disable alarm input channel Supports analog alarm signal to specific alarm output channel.
	Alarm Input	3-ch alarm input (You can set normal open or normal close type to select the alarm type.)
	Alarm Output	3-channel relay output
	Alarm Relay	30VDC 2A, 125VAC 1A (activation alarm)
Interface		
	USB Interface	2 USB 2.0 ports.
	Network connection	RJ45 10M/100M self-adaptable Ethernet port
	RS485	PTZ control port Support various PTZ control protocols.
	RS232	Ordinary COM (Debug), keyboard connection and transparent serial port (COM input and output via network)
System Information		
	Hard Disk Information	Display HDD current status
	Data Stream Statistics	Data stream statistics for each channel (in wave mode)
	Log statistics	Back up to 1024 log files. Support various search engines such as time and type.
	Version	Display version information: channel amount, alarm input and output amount, system version and release date.
	On-line user	Display current on-line user
User Management		
	User Management	Multi-lever user management; various management modes Integrated management for local user, serial port user and network user. Configurable user power.

		Support user /group and its corresponding rights modification. No limit to the user or group amount.
	Password Authentication	Password modification Administrator can modify other user's password.
		Account lock strategy Failing to log in five times within a thirty minute period may result in account lock-out.
Update Tools		
		Web browser and client-end update tool.
Login, Logout and Shut Down		
		Password login protection to guarantee safety
		User-friendly interface when login. Provide the following options: Logout /shutdown/ restart.
		Right authentication when shut down to make sure only those proper people can turn off combo DVR
General		
	Power	100 – 240V-50-60HZ 1.7A (60W)
	Power Consumption	13W (Excluding HDD)
	Working Temperature	0°C – +55°C
	Working Humidity	10% – 90%
	Air Pressure	86kpa – 106kpa
	Dimension (WxDxH)	12 x 3 x 16.75 in (300 x80 x425 mm) (with chassis)
	Weight	11.75 lbs (5.3 Kg) (Excluding HDD)
	Installation Mode	Desktop/wall-mount installation

2. CONTROLS

This section provides information about the front panel and rear panel. Please refer to this before you install the system.

2.1 Front Panel and Side Panel

The front panel is shown in Figure 2-1.

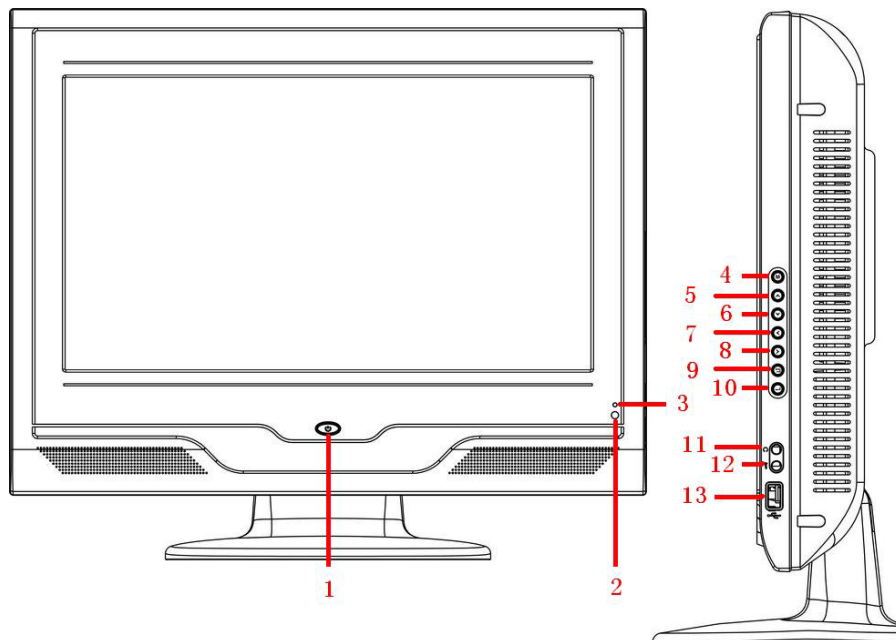

Figure 2-1

Please refer to the following chart for front panel button information.

Number	Function
1	When the device is off, press it for a several seconds to boot up the device. Press it for a short time to turn off screen. When the device is on press it for a long time to shut down the device.
2	Power indication light
3	Infra-red remote control signal receiver
4	Mode button. Used to switch between PC input signal and main board signal.
5	Switch the current activated control. Go upward when used to modify setup. Auxiliary function such as control and switch the PTZ menu.
6	Switch the current activated control. Go downward when used to modify setup. Auxiliary function such as control and switch the PTZ menu.
7	Switch the current activated control. Used to adjust playback control bar to go left during playback.
8	Switch the current activated control. Used to adjust the playback control bar to go right during playback.
9	Go back to the previous menu or cancel current selection.

	Go back to real-time monitor status in playback mode.
10	Confirm current operation. Go to the default button Go to the menu.
11	Bidirectional talk output
12	Bidirectional talk input
13	USB port

2.2 Rear Panel

The rear panel is shown below. See Figure 2-2.

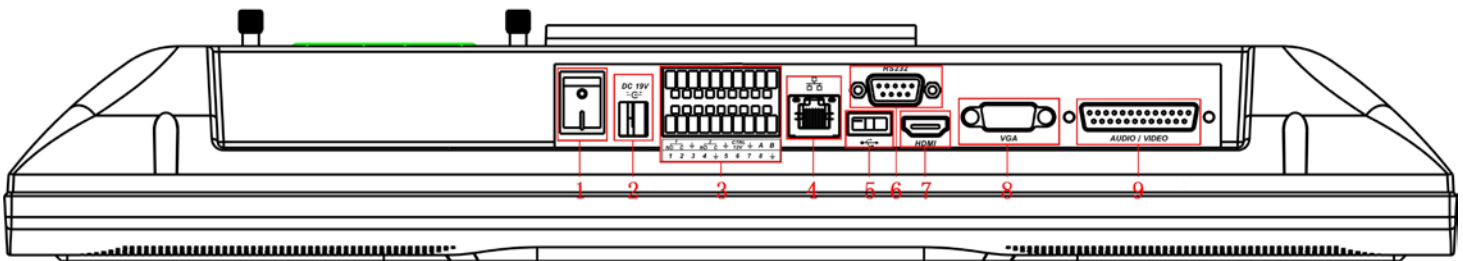

Figure 2-2

Please refer to the following chart for detailed information.

Number	Function
1	Power button
2	Power input port
3	Alarm input/alarm output/RS485 port
4	Network port
5	USB port
6	RS232 port
7	HDMI port
8	PC input
9	Video CVBS input, audio CVBS input, video CVBS output, audio CVBS output.

2.3 Remote Control

The remote control interface is shown in Figure 2-3

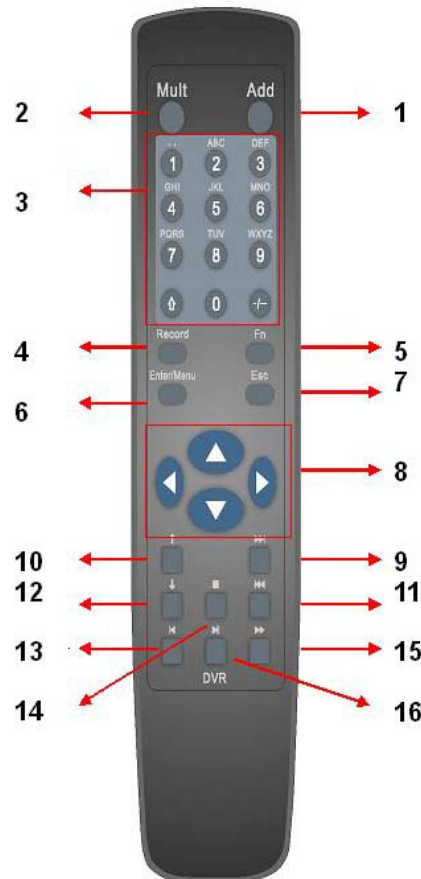

Figure 2-3

Num	Name	Function
1	Address	Click to input device serial number
2	Multiple-window switch	Switch between multiple-window and one-window view
3	0-9 number key	Input password, channel or switch channel.
4	Record	Start or stop recording manually In record interface, working with the direction buttons to select the channel to record
5	Auxiliary key	In 1-ch monitor mode: pop up assistant function: PTZ control and Video color Switch the PTZ control menu in PTZ control interface. In motion detection interface, functions as a directional key to complete setup Backspace: Press for 1.5 seconds to clear all contents in current text box. In HDD information interface, used to switch between HDD record time and other information Special combined operation in some menus.



6	Confirm /menu key	go to default button
		go to the menu
7	Cancel	Go back to previous menu or cancel current operation (close upper interface or control)
		In playback mode, it goes to real-time monitor mode.
8	Direction keys	Switch current activated control, go to left or right.
		In playback mode, it is to control the playback process bar.
		Aux function(such as switch the PTZ menu)
9	Forward	Various forward speeds and normal speed playback.
10	Previous	In playback mode, playback the previous video.
11	Backward	Various backward speeds and normal speed playback.
12	Stop	In playback mode, stop current playback.
13	Next	In playback mode, playback the next video.
14	Slow play	Multiple slow play speeds or normal playback.
15	Play/Pause	Reverse playback or paused mode, click this button to realize normal playback.
		In normal playback click this button to pause playback.
		In pause mode, click this button to resume playback.
		In real-time monitor mode, click this button to enter video search menu.
16	Fast play	Various fast speeds and normal playback.

2.4 Mouse Control

The mouse control interface is shown in Figure 2-4.



Figure 2-4

Left click mouse	System pops up password input dialogue box if you have not logged in.
	In real-time monitor mode, you can go to the main menu.
	When you have selected one menu item, left click mouse to view menu content.
	Implement the control operation.
	Modify checkbox or motion detection status.
Click combo box to pop up drop down list	
	 <p>In input box, you can select input methods. Left click the corresponding button on the panel you can input number/English character (small/capitalized). ← stands for backspace button. _ stands for space button. _stands for input a backspace icon and ← stands for deleting the previous character.</p>  <p>In number input mode: _ stands for clear and ← stands for deleting the previous numeral.</p> <p>When inputting special sign, you can click corresponding numeral in the front panel to input. For example, click numeral 1 you can input “/” , or you can click the numeral in the on-screen keyboard directly.</p> 

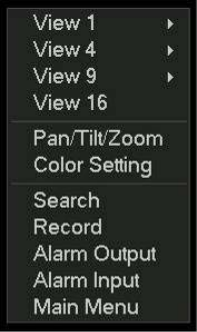
Double Left Click mouse	Implement special control operation such as double click one item in the file list to playback video.
	In multiple-window mode, double left click one channel to view in full-window. Double left click current video again to go back to previous multiple-window mode.
Right Click Mouse	Real-time monitor mode, pop-up shortcut menu: one-window, four-window, nine-window and sixteen-window, Pan/Tilt/Zoom, color setting, search, record, alarm input, alarm output, main menu. Adjust Pan/Tilt/Zoom and color setting for current selected channel. If you are in multiple-window mode, system automatically switches to the corresponding channel.
	
	Exit current menu without saving the modification.
Middle Button	In numeral input box: Increase or decrease numeral value.
	Switch the items in the check box.
	Page up or page down
Move mouse	Select current control or move control
Drag mouse	Select motion detection zone
	Select privacy mask zone.

3. Installation and Connection

Note: When installing and operating you should follow common safety guidelines.

3.1 What's in the Box

When you receive the combo DVR, please check for any visible damage. The protective materials used for the packaging of the combo DVR can protect it from most damage during transportation.

Open the box to check the accessories and verify that you have received the following items:

● 1-Combo DVR LCD unit	● 1-Stand	● 1-Remote Control
● 1-Software CD	● 1-User's Manual	● 1-Mouse
● 1-Ethernet Cable	● 1-Video/Audio Dongle	

3.2 Connection Diagram

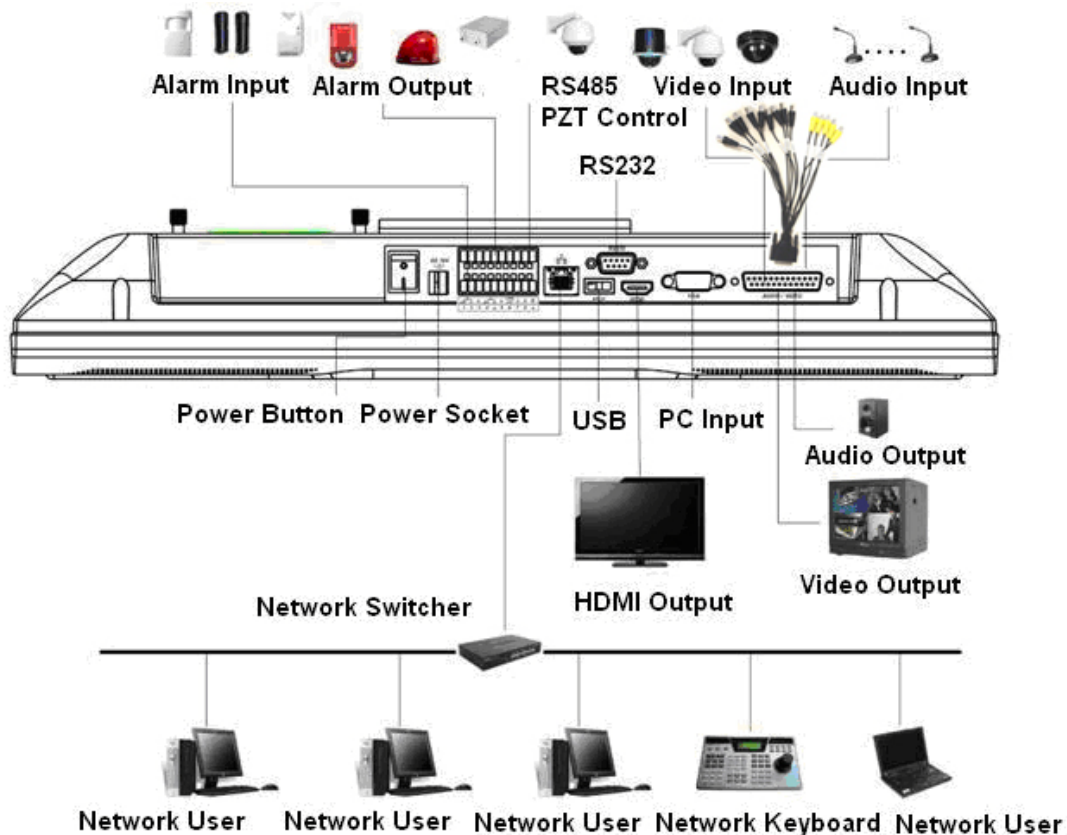

**Illustrated Connection Suggestion*

3.3 Device Installation

The DVR supports two installation modes: desktop/ wall-mount. The default installation is the desktop type. Refer to Figure 3-1.

You will need to purchase the wall mount accessories for wall mount type installation.

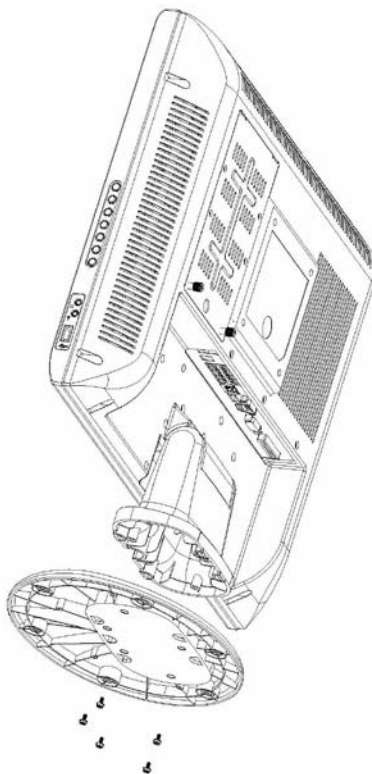

Figure 3-1

3.4 Hard Drive Installation

This combo DVR supports one SATA Hard Drive of 7200rpm or higher. Refer to the Appendix A for a list of recommended Hard Drive brands and models.

Please follow the instructions below to install the HDD:

NOTE: If your DVR came with a pre-installed hard drive you do not need these instructions unless you replace or upgrade the hard drive.



1. Insert the key in the lock and press down. Turn clockwise 90 degrees to unlock.



2. Loosen the two screws on the HDD cover.



3. Remove the HDD cover from the rear panel.



4. Connect the HDD cable and power cable.

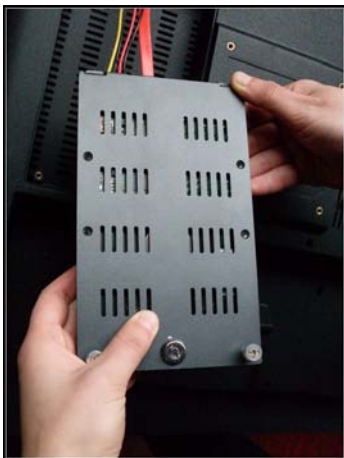

5. Place the HDD cover on the HDD lining up the four holes of the cover and drive.



6. Use the screws to attach the HDD to the cover. Recheck connection of HDD cables before closing



7. Place the HDD with the HDD cover back into the slot. And then attach the two screws firmly.



8. Insert the key into the hole and then press. Turn the key counter clockwise 90 degrees to secure the lock.

3.5 Connecting Power Supply

We recommend you use UPS (uninterrupted power supply) to guarantee steady operation, combo DVR life span, and other peripheral equipment's operation such as cameras. We also strongly recommend that you plug the DVR and cameras into a transient voltage surge protector (UL-1449 rating). Look for a clamping voltage of 330 or lower, Joule rating of at least 400, and a response time of 10 nanoseconds or less.

3.5.1 Connecting Video Input

The video input interface is BNC. The input video formats include: PAL/NTSC (See Figure 3-2)

The video signal complies with North American NTSC video standards.

We recommend setting your video up in an area with low video input signal distortion and interference in an area with suitable lighting.

Ensure the stability and reliability of camera signal:

The camera should be positioned so that direct sunlight does not shine into it, and away from flammable, explosive substances. Cameras and DVR should share the same grounding if possible to ensure normal operation of cameras.

Ensure stability and reliability of the cables

If you are running cables more than 200 feet or installing cable in walls, we recommend using high quality shielded RG59 cables. If you plan on running cables over 800 feet, we recommend using a higher quality shielded cable such as RG6.

For distances above 1,800 feet, we recommend using fiber optic cable to ensure video quality.

Keep the video signal away from any strong electromagnetic interference.

Make sure cables are well connected to DVR

The cable should be fixed firmly to the BNC connectors on the dongle.

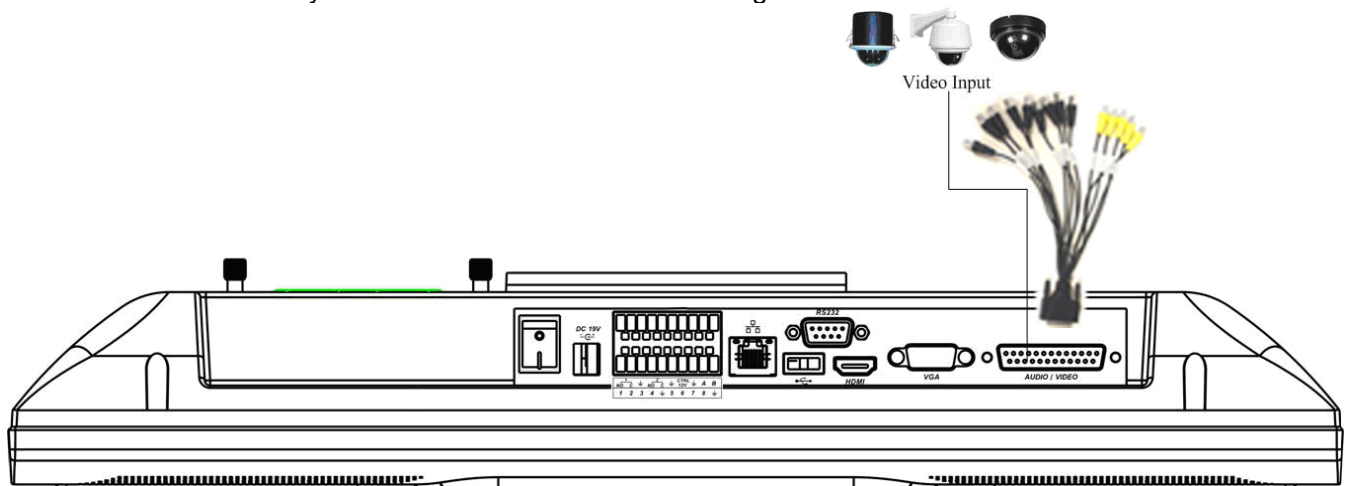

Figure 3-2

3.5.2 Connecting Video Output

Video output includes BNC (PAL/NTSC BNC (1.0VP- P , 75Ω) output and HDMI output.

System supports BNC and HDMI output at the same time. (See Figure 3-3)

- When hooking your system up to a PC monitor through the BNC video out port you will need to use a composite to VGA converter box. We do not recommend attaching to RCA ports on a TV through the BNC output because it can damage the TV, DVR, or both.

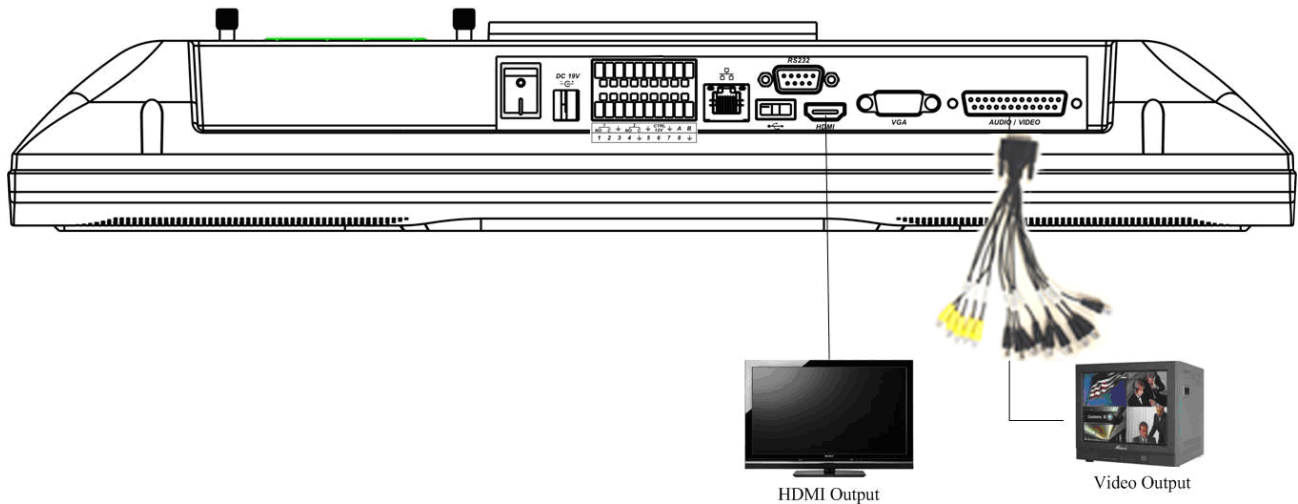

Figure 3-3

3.6 Connecting Audio Input & Output, Bidirectional Audio

3.6.1 Audio Input

This product uses BNC ports. Audio transmission is similar to video transmission. Try to avoid interference, keep contacts snug and dry, and away from high tension current.

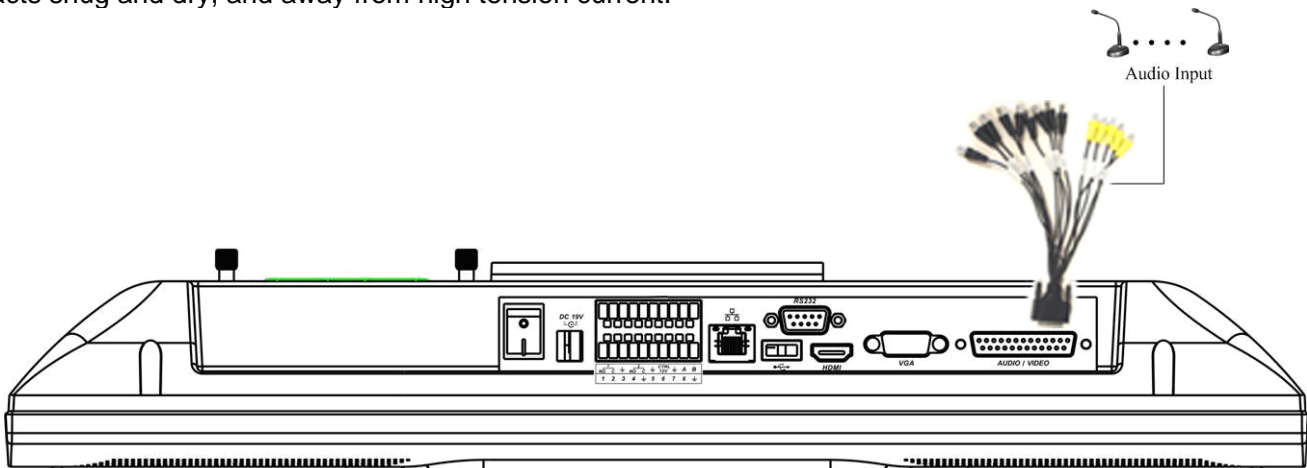

Figure 3-4

3.6.2 Audio Output

The audio output signal parameter is usually over 200mv 1KΩ (BNC). It can directly connect to low impedance earphone, active sound box or amplifier-driven audio output device. (See Figure 3-5)

If the sound box and the pick-up cannot be separated spatially, it is easy to get reverb or squeaking feedback. If feedback occurs, try these tips:

- Use better sound pick-up with better directing properties.
- Reduce the volume of the sound box.
- Using more sound-absorbing materials can reduce voice echo and improve acoustics environment
- Adjust the layout to reduce occurrence of squeaking

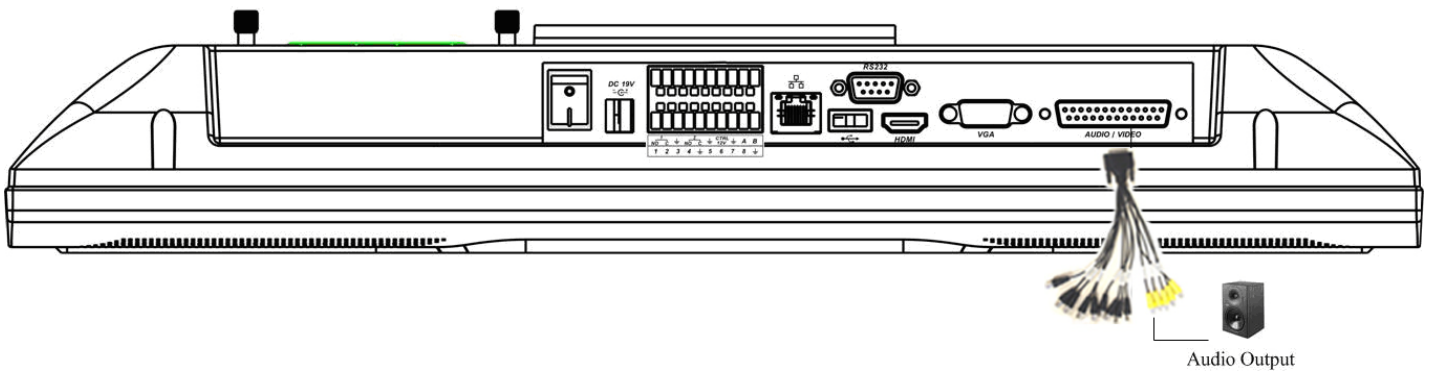

Figure 3-5

3.7 Alarm Input and Output Connection

Refer to the following chart in Figure 3-6 for alarm input and output connection.

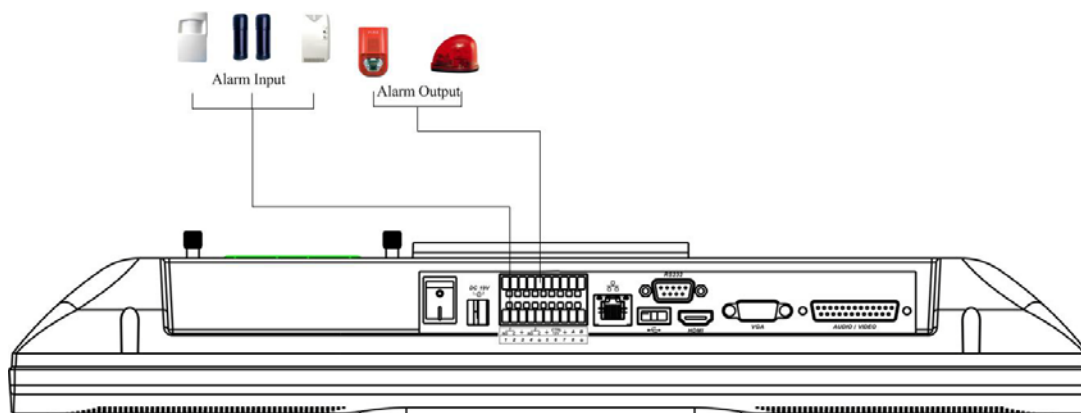

Figure 3-6

There are two alarm input types for you to select: normally open (NO) and normally closed (NC).

1. Alarm input

- Please make sure alarm input is grounded.
- Grounding signal is needed for alarm input.
- When you are connecting two combo DVRs or you are connecting one combo DVR and one other device, please use a relay to separate them

2. Alarm output

The alarm output port should not be connected to high power load directly (It shall be less than 1A) to avoid high current which may result in relay damage. Please use the co-contactor to establish the connection between the alarm output port and the load.

How to connect PTZ camera

- Ensure the camera has the same grounding with combo DVR otherwise you may not control the PTZ. Shielded twisted wire is recommended and the shielded layer is used to connect to the ground.
- For excessively long signal wires, 120Ω should be parallel connected between A, B lines on the far end to reduce reflection and guarantee the signal quality.
- 485 A, B” of combo DVR cannot parallel connect with “485 port” of other device.
- The voltage between of A, B lines of the camera should be less than 5v.
- Ensure the front end device is soundly grounded. Improper grounding may result in chip damage.

3.7.1 Alarm Input and Output Details

You can refer to the following chart and Figure 3-7 for alarm input and output information.

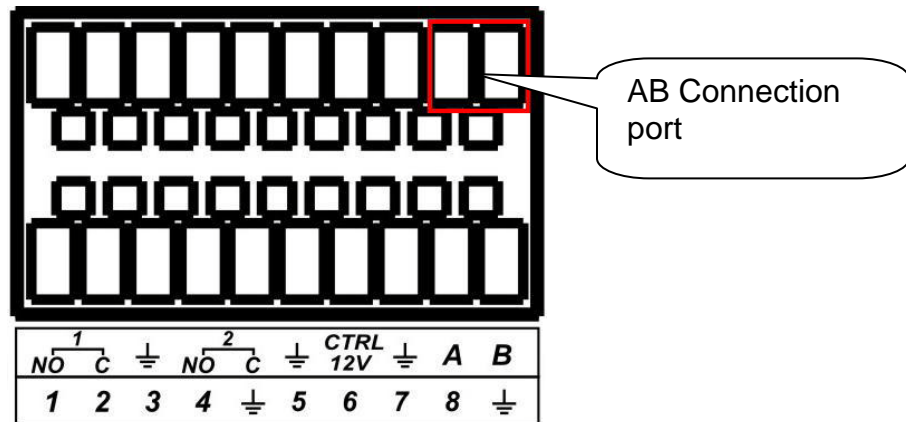



Figure 3-7

Parameter	Grounding Alarm
	Ground line
Alarm Input	1, 2, ..., 8 becomes valid in low voltage.
1-NO C, 2-NO C,	Two NO activation outputs.
CTRL 12V	Controls the power output You need to close the device power to cancel the alarm.
A/B	485 communication port. Used to control devices such as PTZ. Please parallel connect 120Ω between A/B cables if there are too many PTZ cameras

3.7.2 Alarm Input Port

Refer to the following sheet for more information.

- Normal open or Normal close type
- Parallel connect COM end and GND end of the alarm detector (Provide external power to the alarm detector).
- Parallel connect the Ground of the combo DVR and the ground of the alarm detector.
- Connect the NC port of the alarm sensor to the combo DVR alarm input (ALARM)
- Use the same ground with that of combo DVR if you use external power to the alarm device.

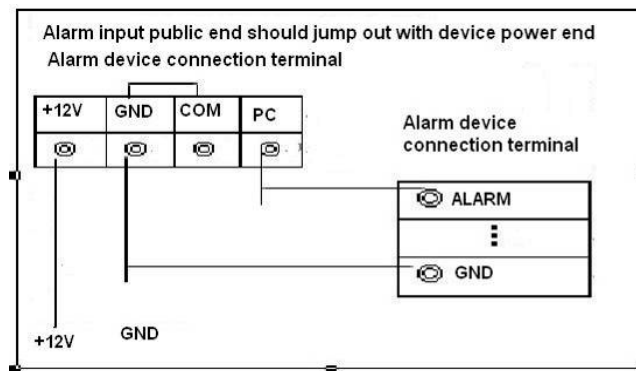

Figure 3-8

3.7.3 Alarm Output Port

- 3 way relay alarm output (NO contact). Provides external power to external alarm device.
- To avoid overloading, please read the following relay parameters sheet carefully.
- RS485 A/B cable is for the A/B cable of the PTZ camera.

Relay Specification

Model:	JRC-27F	
Material of the contact	Silver	
Rating (Resistance Load)	Rated switch capacity	30VDC 2A, 125VAC 1A
	Maximum switch power	125VA 160W
	Maximum switch voltage	250VAC, 220VDC
	Maximum switch currency	1A
Insulation	Between contacts with same polarity	1000VAC 1minute
	Between contacts with different polarity	1000VAC 1minute

	Between contacts and winding	1000VAC 1minute
Surge voltage	Between contacts with same polarity	1500V (10×160us)
Length of open time	3ms max	
Length of close time	3ms max	
Longevity	Mechanical	50×106 times (3Hz)
	Electrical	200×103 times (0.5Hz)
Temperature	-40°C ~+70°C (-40°F to +158°F)	

3.8 RS232

You can connect the combo DVR with POS or Keyboard through RS232.

With POS system, the combo DVR can communicate through RS232 and network. For the POS system, the combo DVR can integrate the text content and even search the record through the info.

The combo DVR also supports NKB operation. You can operate the combo DVR from keyboard controls instead of using the control pad on the front panel of the unit.

3.9 RS485

When the combo DVR receives a camera control command, it transmits that command up the cable to the PTZ camera. RS485 is a single-direction protocol; the PTZ device can't return any data to the unit. To enable the operation, connect the data cable from the PTZ camera to the RS485 (A, B) input on the combo DVR. See Figure 3-9.

Since RS485 is disabled by default for each camera, you must enable the PTZ settings first. This combo DVR supports multiple protocols such as Pelco-D, Pelco-P, as well as most common protocols (26 total).

To connect PTZ cameras to the DVR:

1. Connect RS485 A, B on the DVR rear panel.
2. Connect the other end of the cable to the proper pins in the connector on the camera.
3. Please follow the instructions to configure a camera to enable each PTZ device on the combo DVR.

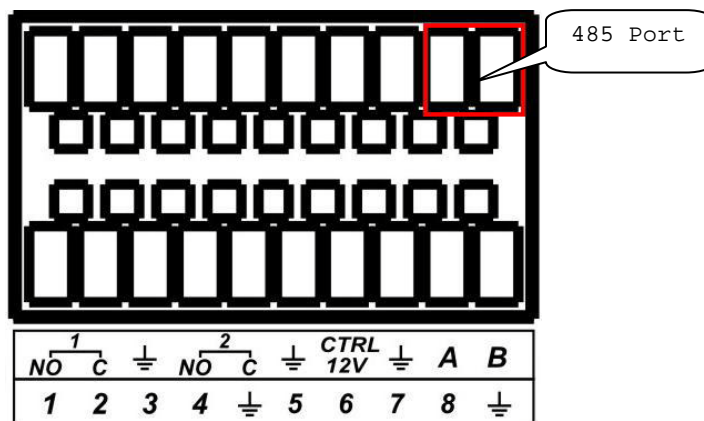

Figure 3-9

3.10 Other Interfaces

There are other interfaces on the combo DVR, such as USB ports. You can refer to Figure 3-10 for more information.

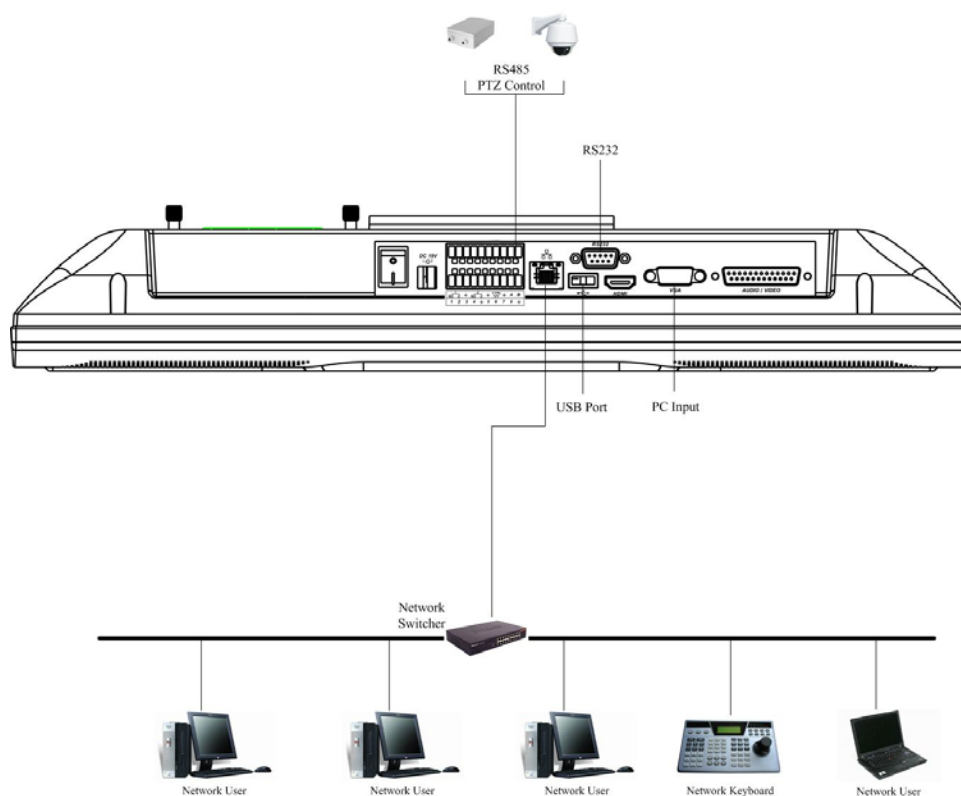

Figure 3-10

4. NAVIGATION AND CONTROLS

Overview of Navigation and Controls

Before operation, please make sure:

- You have properly installed a hard drive and all the cable connections.
- The provided input power and the device power are matched.
- The external power source is within 100–240V-50-60HZ 1.7A (60W) and the current is stable.

NOTE: We also STRONGLY recommend that you plug the DVR and cameras into a Transient Voltage Surge Protector (UL-1449 rating). Look for a clamping voltage of 330 or lower, Joule rating of at least 400, and a response time of 10 nanoseconds or less.

4.1 Login, Logout & Main Menu

4.1.1 Login

After system boots up, the default video display is in multiple-window mode. Click Enter or left click mouse and you will see the login interface illustrated in Figure 4-1. Use the USB mouse, front panel buttons, remote control or keyboard to navigate through the system log in screen. Click **123** to switch between numbers, letters (small/capitalized) and symbols.

There are four types of account access you can assign to users who log in to your DVR:

- **Username:** admin. **Password:** admin. (administrator, local and network)
- **Username:** 888888. **Password:** 888888. (administrator, local only)
- **Username:** 666666. **Passwords:** 666666 (Lower authority user who can only monitor, playback, backup etc.)

It is highly recommended that you change your system password after you log on for the first time. Write your changes down or keep them in a safe place because the system will lock you out if you login in incorrectly three times within a 30 minute period. If this occurs, wait 30 minutes, reboot the DVR, and try to log in again.



Figure 4-1

4.1.2 Main Menu

After you log in, you will access the system main menu shown in Figure 4-2.

There are six icons: search, information, setting, backup, advanced and shutdown.

You can move the cursor to highlight an icon, and then double click mouse to enter the sub-menu.

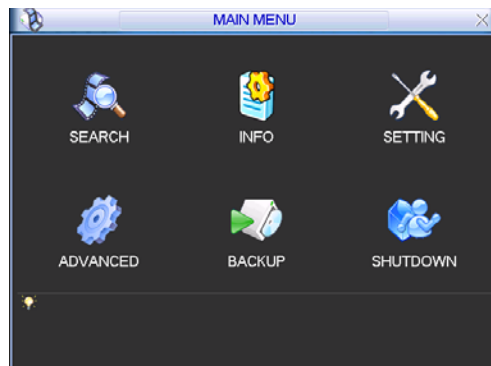

Figure 4-2

4.1.3 Logout

There are two ways to log out.

One is from the main menu:

In the main menu, click the shutdown button. This will generate the interface shown below. See Figure 4-3



Figure 4-3

From the drop down menu shown in Figure 4-3, you will be given several log out options. See Figure 4-4.

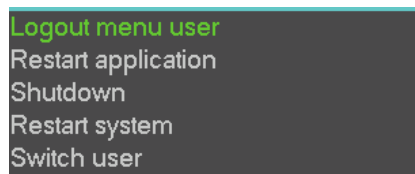

Figure 4-4

The other way to log out is to press the power button on the front panel for at least 3 seconds. The system will stop all operations and you can then click the power button in the rear panel to turn off the combo DVR.





4.1.4 Auto Resume after Power Failure

The system can automatically backup video and resume previous working status after power failure.

4.2 Manual Recording

4.2.1 Live Viewing

After you log in, the system is in live viewing mode. You can see system date, time and channel name. If you want to change system date and time, you can refer to general settings (Main Menu->Setting->General). If you want to modify the channel name, please refer to the display settings (Main Menu->Setting->Display)

1		Recording status	2		Motion detection	3		Video loss	4		Camera lock
---	---	------------------	---	---	------------------	---	---	------------	---	---	-------------

4.2.2 Manual Record

Note: You have to have access rights to access to the Manual Record menu and a hard drive needs to be properly installed.

4.2.2.1 Manual Record Menu

There are two ways for you to get to the manual record menu.

- Right click mouse or in the main menu, Advanced->Manual Record.
- In live viewing mode, push record button on the front panel or record button on the remote control.

4.2.2.2 Basic Operation

There are three status modes: schedule/manual/stop. Highlight icon “○” to select corresponding channel.

- Manual: The highest priority. After manual setup, all selected channels will begin ordinary recording.
- Schedule: Cameras record as you have set in recording setup (Main Menu->Setting->Schedule)
- Stop: All channels stop recording.



Figure 4-5

4.2.2.3 Enable/Disable Record

Please check current channel status: “○” means it is not recording, “●” means it is recording. You can use mouse or direction keys to highlight channel number as illustrated in Figure 4-6.



Figure 4-6

4.2.2.4 Enable all channel recording

By clicking “o” below “All” (as illustrated in Figure 4-7), you can enable all channel recording.

- All channel schedule record
Click “ALL” next to “Schedule” as illustrated in Figure 4-7.
When system is in schedule recording, all channels will record as you have previously set (Main menu->Setting->Schedule).
The corresponding indication light on front panel will turn on.

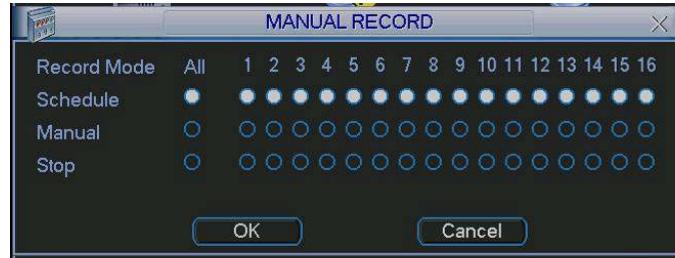

Figure 4-7

- All channel manual record
Click “ALL” next to “Manual” as illustrated in Figure 4-8.
When system is manual recording, all schedules you have set up will be off (Main menu->Setting->Schedule).
You can see indication light on front panel turns on, system begins manual record now.

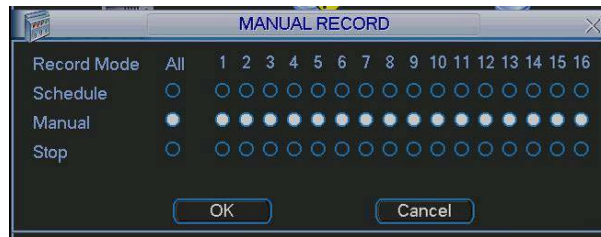

Figure 4-8

4.2.2.5 Stop All Channel Recording

Click “ALL” next to “Stop” as illustrated in Figure 4-9.

System stops all channel recording no matter what mode you have set in the menu (Main menu->Setting->Schedule)

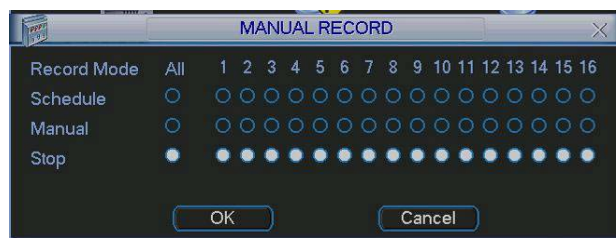

Figure 4-9

4.3 Search & Playback

4.3.1 Search Menu

Click search button in the main menu, search interface is shown below. See Figure 4-10. Usually there are three file types:

- R: Regular recording file.
- A: External alarm recording file.
- M: Motion detection recording file

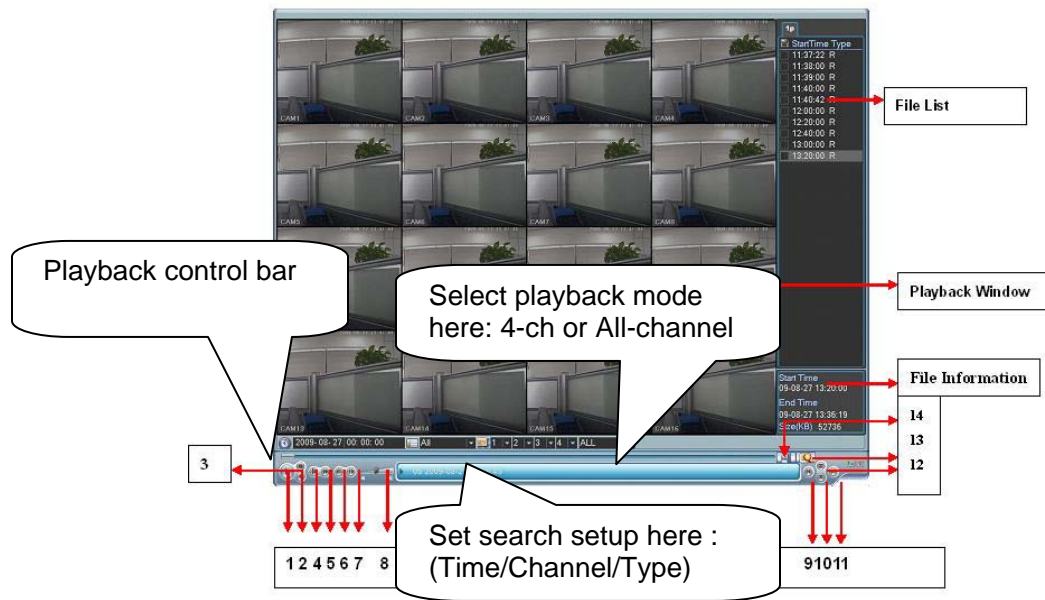

Figure 4-10

Please refer to the following chart for more information.

Number	Function
1	Play
2	Backward
3	Stop
4	Slow play
5	Fast play
6	Previous frame
7	Next frame
8	Volume
9	Previous file
10	Next channel
11	Next file
12	Previous channel
13	Search
14	Backup

4.3.2 Playback

There are various search modes: video type, channel number or time. The system can display a maximum of 128 files on one screen. You can use page up/down button to view if there is more than one page. Select the file name and double click mouse (or click enter button), you can view file content.

4.3.2.1 Playback Mode

There are two playback modes: 4-ch and all-channel. In 4-ch playback mode, you can select the 1/2/3/4-ch playback according to your requirements. In all-channel mode, system can playback on all channels.

4.3.2.2 Accurate Playback

Input time (h/m/s) in the time column and then click playback button, system will start playback.

4.3.2.3 Synchronized Playback Function when Playing Back

While playing back, click a number key, the system will switch to that channel's video for that time.

4.3.2.4 Digital Zoom

When the system is in full-screen playback mode, drag your mouse on the screen to select a section and then left click mouse to digitally zoom in on that section. You can right click mouse to exit.

4.3.2.5 File Backup

System supports backup operation during search. You can click to put a v before file name (multiple choices). Then click backup button (Button 14 in Figure 4-10).

4.3.2.6 Slow Playback and Fast Playback

Refer to the following table for slow play and fast playback function:

Button	Function	Notes
Fast play button ►►	In playback mode, click this button to switch between various fast play modes such as fast play 1, fast play 2 etc.	Frame rate may vary due to different versions.
Slow play button ►	In playback mode, click this button to switch between various slow play modes such as slow play 1 or slow play 2.	
Play/Pause ►	In slow playback mode, click this button to switch between play/pause modes.	
Previous/next	In playback mode, you can click ◀ and ▶ to view previous or next video on current channel.	

4.3.2.7 Reverse Playback and Frame by Frame Playback

Button	Illustration	Remarks
Reverse play: ◀ in playback interface.	In normal playback mode, left click reverse play button◀, system begins reverse playback. Double click reverse play button again, system goes to pause mode.	When system is in reverse play or frame by frame playback mode, you can click play button▶ / to go to normal playback.
Manual playback frame by frame.	Click pause button in normal playback mode, you can use ◀ and ▶ to view frame by frame.	

4.3.3 Calendar

Click the calendar icon  illustrated in Figure 4-10 to generate a pop-up calendar. Highlighted dates indicate that there are recorded files on that day. You can click on the dates highlighted in blue (see Figure 4-11) to view file list. In Figure 4-11 there are video files on June 13th and June 14th. Double click the date to view its file list.



Figure 4-11

4.4 Schedule

After the system boots up, it is in default 24-hour regular mode. You can set record type and time in the schedule interface.

4.4.1 Schedule Menu

From the main menu, you can click the schedule option to get to the schedule menu illustrated in Figure 4-12

- Channel: Please select the channel number first. You can select "all" if you want to set the same schedule for all of the channels.
- Week day: There are eight options: from Saturday to Sunday and all.
- Pre-record: System can pre-record the video before the event occurs into the file. The value ranges from 1 to 30 seconds depending on the bit stream.
- Redundancy: Please note redundancy function **does not** apply to current series since there is only one hard drive.
- Snapshot: You can enable this function to take a snap shoot of image when alarm occurs.
- Record types: There are three types: regular, motion detection (MD) and Alarm.

Click the  icon to select the corresponding function. After completing all the setups, click the save button and the system will go back to the previous menu.

At the bottom of the menu, there are color bars for your reference. Green represents regular recording, yellow is for motion detection and red represents alarm recording.

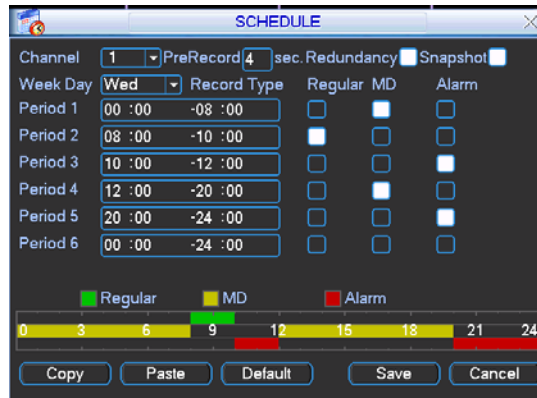

Figure 4-12

4.4.2 Quick Setup

This function allows you to copy one channel setup to another. After setting up channel 1, you can click the copy button and then paste the set up options of channel 1 to channel 2 or any other channel. Once you are done adjusting the setups of your channels, click the save button to finalize your chosen set up options.

4.4.3 Snapshot

4.4.3.1 Schedule Snapshot

In Encode interface, click snapshot button to input snapshot mode, size, quality and frequency. In General interface setup upload interval (Figure 4-14).

In Schedule interface (Figure 4-12), enable snapshot function.

Refer to Figures 4-13 through 4-15 for more detailed information.



Figure 4-13



Figure 4-14



Figure 4-15

4.4.3.2 Activate Snapshot

Please follow the steps listed below to enable the activate snapshot function. After you have enabled this function, the system can now take snapshots when corresponding alarm occurs.

- In Encode interface, click snapshot button to input snapshot mode, size, quality and frequency (see Figure 4-16).
- In General interface please input upload interval (see Figure 4-14).
- In Detect interface please enable snapshot function for specified channels. Or in alarm interface please enable snapshot function for channels you want.

Refer to Figures 4-16 Through 4-18 for a more detailed illustration.



Figure 4-16

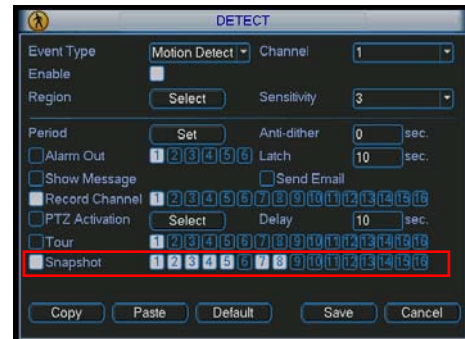

Figure 4-17



Figure 4-18

4.4.3.3 Priority

Note: The activate snapshot setting takes priority over the schedule snapshot setting. If you have enabled both types of settings at the same time, the system will activate the “activate snapshot” setting when an alarm occurs automatically.

4.4.4 Image FTP

In Network interface, you can set FTP server information. Enable FTP function and then click save button. See Figure 4-19.

Boot up corresponding FTP server.

Enable schedule snapshot (Chapter 4.4.3.1) or activate snapshot (Chapter 4.4.3.2) first, now system can upload the image file to the FTP server.

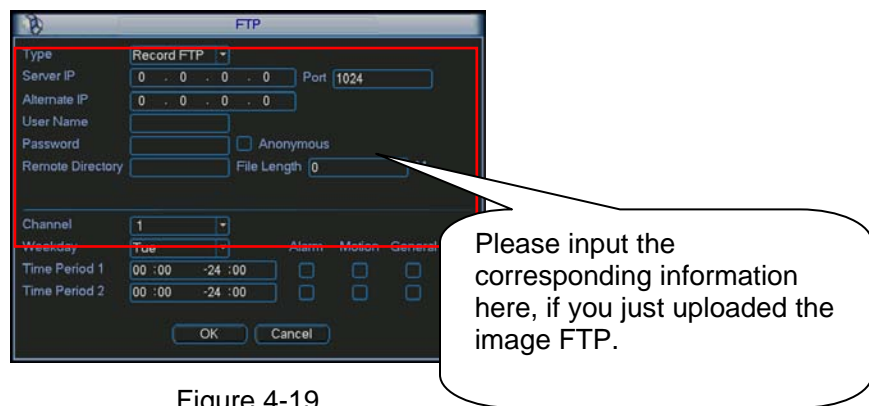

Figure 4-19

4.5 Motion Detection

4.5.1 Go to Detect Menu

In the main menu, click Setting, then Detect to obtain the motion detection interface illustrated in Figure 4-20. The three detection modes available are motion detection, video loss and camera masking.

4.5.2 Motion Detect

Detection menu is illustrated below in Figure 4-20:

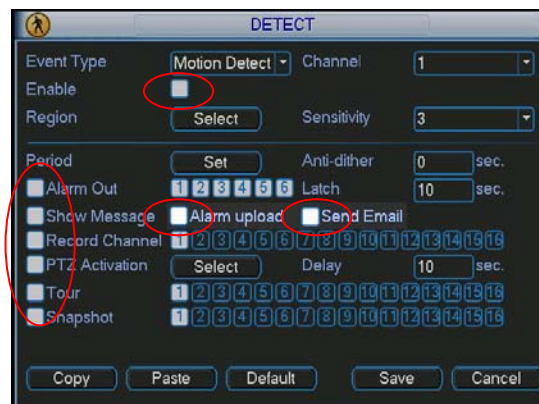

Figure 4-20

- Event type: from the dropdown list you can select motion detection type.
- Channel: select the channel to activate recording function once alarm occurs. Please make sure you have set MD record in encode interface (Main Menu->Setting->Schedule) and schedule record in manual record interface (Main Menu->Advanced->Manual Record)
- Latch: when motion detection event ends, system auto delays detecting again for a specified time. The value ranges from 10-300 seconds.
- Region: Click select button in the "Region" portion of the Detect menu illustrated in Figure 4-20. Here you can set the motion detection zone. As illustrated in Figure 4-21 below, there are 396 (22*18 PAL) /330 (22*15 NTSC) small zones. The green square is current cursor position. The Red zone is the motion detection zone. Black zone is the disarmed zone. You can click the Fn button on the remote to switch between the arm mode and disarm mode. In arm mode, you can click the direction buttons to move the green rectangle to set the motion detection zone. After you completed the setup, please click ENTER button to exit current setup. Click save button to save current setup. If you click ESC button to exit the region setup interface the system will not save your zone setup.
 NOTICE: as shown in Figure 4-21, you can left click the mouse and then drag it to set a region for motion detection. Click Fn to switch between arm/withdraw motion detection. After setting, click enter button to exit.

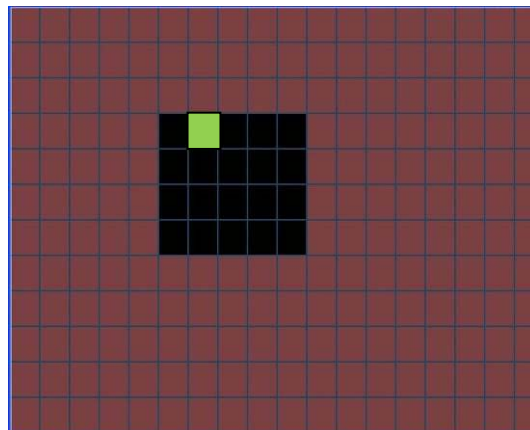

Figure 4-21

- Sensitivity: System supports 6 levels. The sixth level has the highest sensitivity.
- Show message: System can pop up a message to alert you in the local host screen if you enable this function.
- Alarm upload: System can upload the alarm signal to the network (including alarm center) if you enable this function.
- Send email: System can send out an email to alert you when alarm occurs.
- PTZ activation: Here you can set PTZ movement when alarm occurs. Such as go to preset, tour & pattern when there is an alarm. Click "select" button, you can see the interface shown in Figure 4-22. Please note: motion detection can only activate the preset.

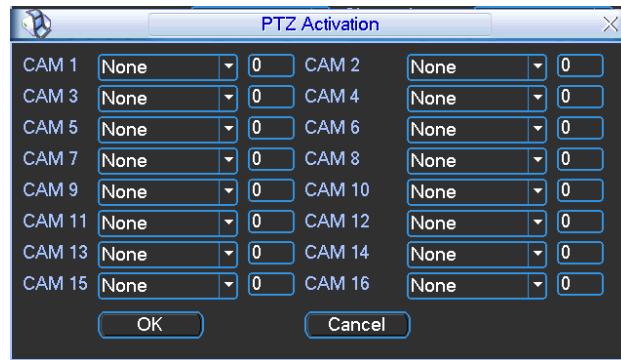

Figure 4-22

- **Period:** Click set button (Figure 4-20), you can see the interface shown in Figure 4-23. Here you can set for business day and non-business day as illustrated in Figure 4-24. Click set button to generate the interface shown in Figure 4-24. Here you can set your own setup for business day and non-business day.

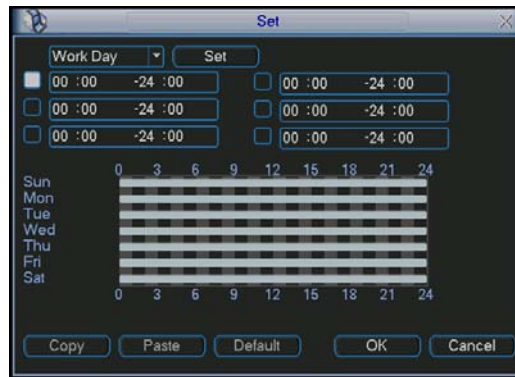

Figure 4-23

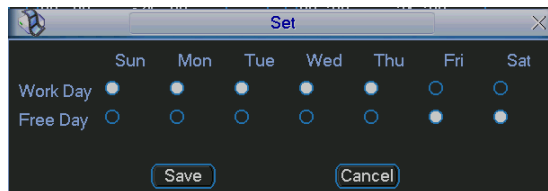



Figure 4-24

- **Anti-dither:** Here you can set anti-dither time. This is the time you would want the system to delay before starting recording on a motion alarm.
- **Alarm output:** when an alarm occurs, system can upload alarm to the network (Including the alarm center.)
- **Tour:** Here you can enable tour function when alarm occurs. It is a one-window tour. Please go to chapter 5.3.9 Display for tour interval setup.

Please highlight icon  to select the corresponding function. After all the setups are complete click save button, system goes back to the previous menu.

Note:

In motion detection mode, you can not use copy/paste to set channel setup since the video in each channel may not be the same.

4.5.3 Video Loss

As illustrated in Figure 4-25, select video loss from the Event Type list. This function informs you when video loss has occurred. You can enable alarm output channel and then enable show message function.

Tips:

You can enable preset/tour/pattern activation operation when video loss occurs. Refer to chapter 4.5.2 motion detection for detailed information.

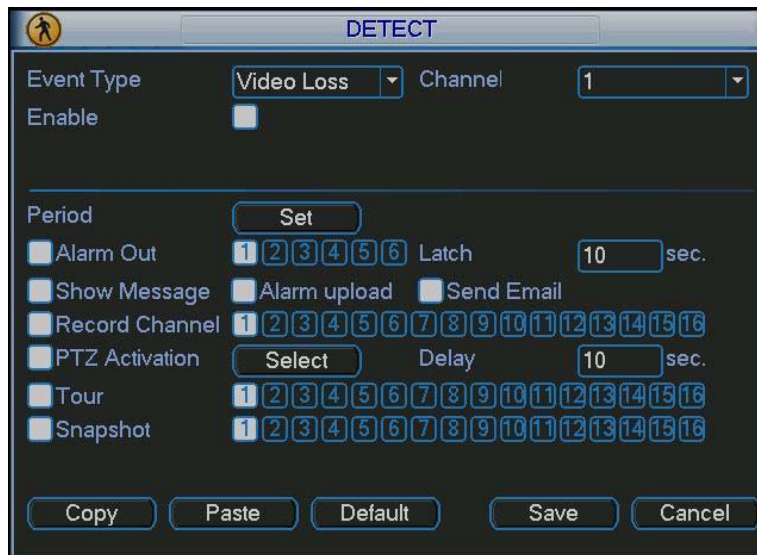

Figure 4-25

4.5.4 Camera Masking

When someone viciously masks lens, the system can alert you to guarantee video continuity. Camera masking interface is shown in Figure 4-26.

Note:

In Detect interface, copy/paste function is only valid for the same type, which means you cannot copy a channel setup in video loss mode to camera masking mode.

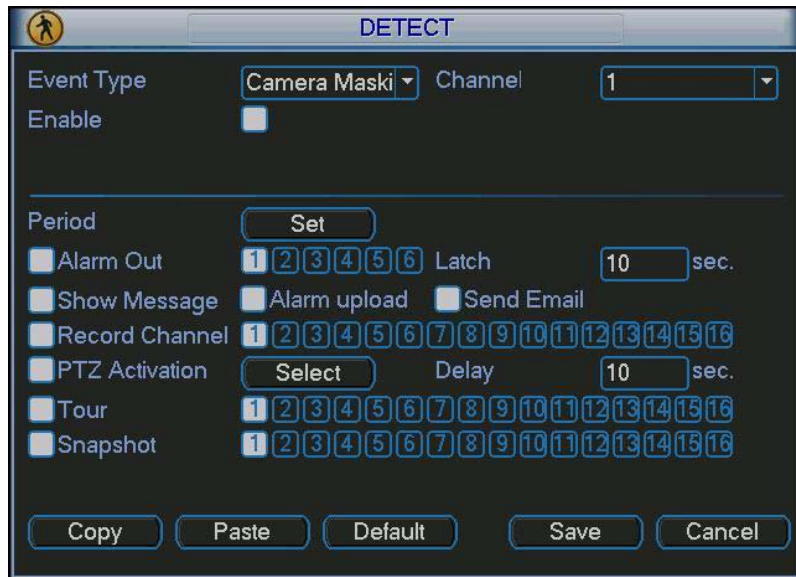

Figure 4-26

4.6 Alarm Setup and Alarm Activation

Before operation, please make sure you have properly connected any external alarm devices such as a buzzer.

Go to alarm setup interface

In the main menu, choose Setting, then Alarm to get to the Alarm setup interface illustrated in Figure 4-27.

4.6.1 Alarm setup

Alarm interface is shown below in Figure 4-27

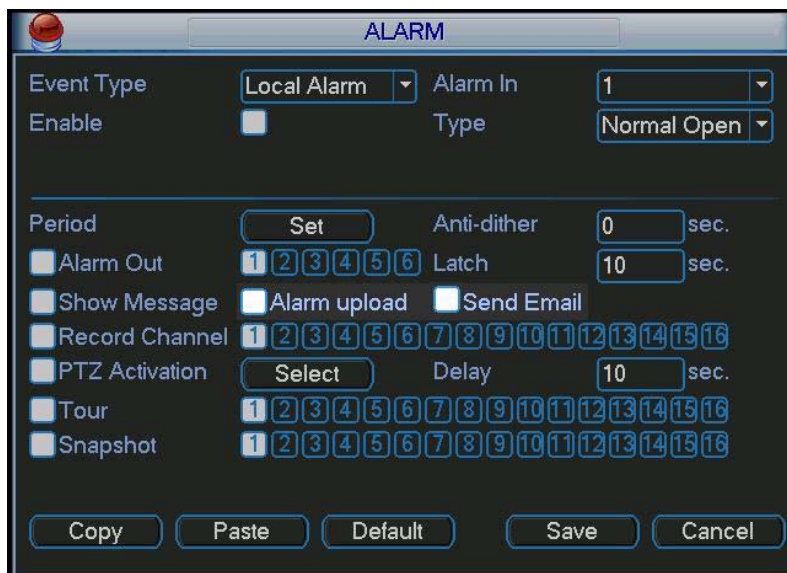

Figure 4-27

- Alarm in: Here you select channel number.
- Event type: There are two types. One is local input and the other is network input.
- Type: normally open or normally closed.
- PTZ activation: Here you can set PTZ movement when alarm occurs. Such as go to preset, tour & pattern when there is an alarm. Click “select” button to generate the interface illustrated in Figure 4-28.

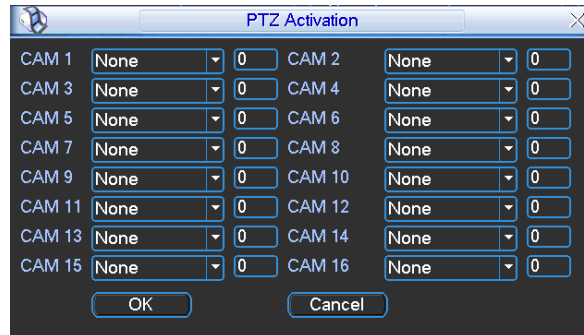

Figure 4-28

- Period: Click set button to generate the user interface illustrated in Figure 4-29. Here you can set for business day and non-business day.

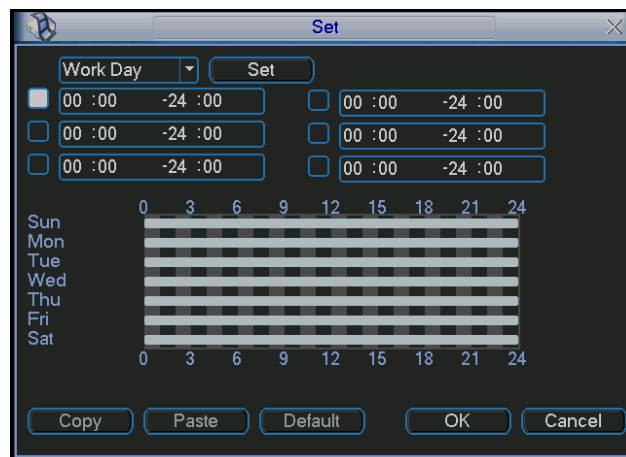

Figure 4-29

- Click the set button in Figure 4-29 to generate the Set up screen dialog illustrated in Figure 4-30. Here you can set your own setup for business day and non-business day.

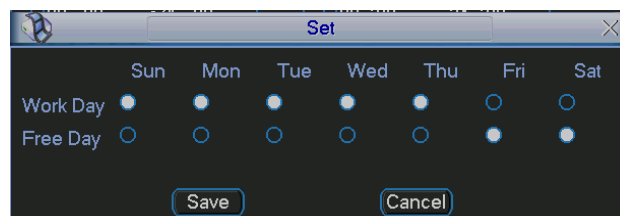



Figure 4-30

- Anti-dither: Here you can set anti-dither time. This is the time you would want the system to delay before starting recording on a motion alarm.
- Show message: System can display a message to alert you in the local host screen if you have enabled this function.
- Alarm upload: System can upload the alarm signal to the network (including alarm center) if you enabled current function.
- Send email: System can send out email to alert you when alarm occurs.
- Record channel: you can select proper channel to record alarm video (Multiple choices). At the same time you need to set alarm record in schedule interface (Main Menu->Setting->Schedule) and select schedule record in manual record interface (Main Menu->Advance->Manual Record).
- Latch: Here you can set a time to continue recording after motion stops. Value ranges from 10 to 300 seconds. System delays this long before turning off alarm and de-activating output after external alarm is cancelled.
- Tour: Here you can enable tour function when alarm occurs. It is a one-window tour: go to chapter 5.3.9 Display for tour interval setup.
For snapshot operation, please refer to chapter 4.4.3.

Please highlight icon  to select the corresponding function. After setting all the setups please click save button, system goes back to the previous menu.

4.7 Backup

Combo DVR supports USB device backup and network download. Here we cover USB backup. You can refer to Chapter 7 Web Operation for network download backup operation.

4.7.1 Detect Device

Click the backup button to generate the interface shown in Figure 4-31. Here you can view device information such as total capacity and status.

You can view backup device name and its total space and free space. The devices include USB burner, flash drive, SD card and USB hard drive.

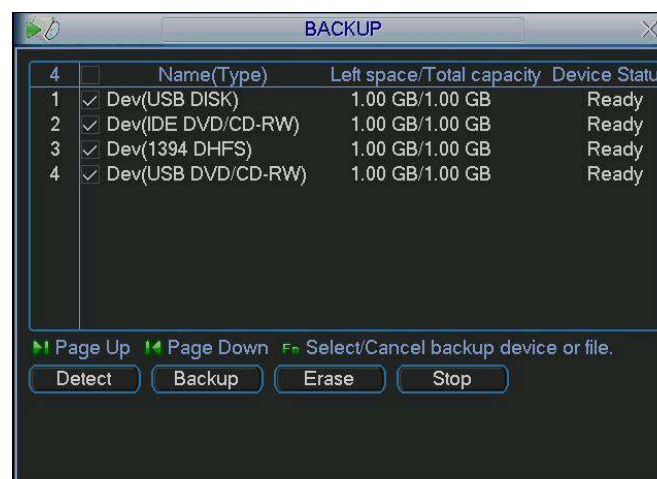

Figure 4-31

4.7.2 Backup Device

Select backup device and then set channel, file start time and end time.

Click add button, system begins search. All matched files are listed below. System automatically calculates the capacity needed and remaining as illustrated in Figure 4-32. Note that the system will only back up files with a ✓ before channel name. You can use Fn on remote or cancel button to delete ✓ next to the file number. Click the backup button and you will backup selected files. A progress bar will be displayed showing your progress in the backup. When the system completes backup, you will see a dialogue box notifying you the files have been successfully backed up.



Figure 4-32

After you click backup button, and system begins the backup, the backup button will function as a stop button. You can view the remaining time and process bar at the left bottom as shown in Figure 4-33.

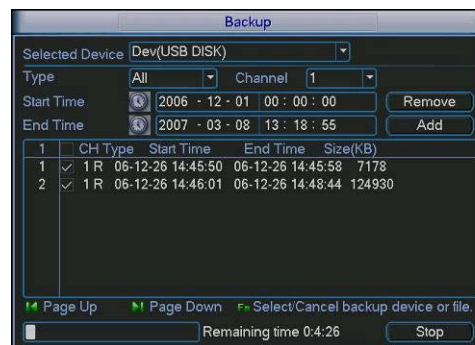

Figure 4-33

The file name convention is as follows: SN_CH+channel number+time Y+M+D+H+M+S. In the file name, the YDM format is the same as you set in general interface. (Main Menu ->Setting ->General). File extension type is dav. The files can be played back using the player on the CD that comes with the DVR.

Tips:
 During backup process, you can click ESC to exit current interface for other operation. The system will not terminate backup process.

Note:
 When you click stop button during the backup process, the stop function becomes activated immediately. For example, if there are ten files, when you click stop if system has just backed up five files, system only save the previous 5 files in the device (But you can view ten file names).

4.8 PTZ Control and Color Setup

Note: All the operations here are based on PELCOD protocol. For other protocols, there might be differences.

4.8.1 Cable Connection

Please follow the procedures below to connect the cables

- Connect the dome RS485 port to combo DVR 485 port.
- Connect dome video output cable to combo DVR video input port.
- Connect power adapter to the dome.

4.8.2 PTZ Setup

Note: The camera video should be in the current screen. Before setup, please check that the following connections are right:

- PTZ video and data connection is right. PTZ address setup is right.
- Camera A (B) line connects with combo DVR A (B) line.

Boot up the combo DVR, input user name and password.

In the main menu, click setting, and then click Pan/Tilt/Zoom Control button. The interface is shown in Figure 4-34. Here you can set the following items:

- Channel: select the current camera channel.
- Protocol: select corresponding PTZ protocol (such as PELCOD)
- Address: default address is 1.
- Baud rate: select corresponding baud rate. Default value is 9600.
- Data bits: select corresponding data bits. Default value is 8.
- Stop bits: select corresponding stop bits. Default value is 1.
- Parity: there are three options: odd/even/none. Default setup is none.

NOTE: These settings must match the settings on the PTZ camera control board

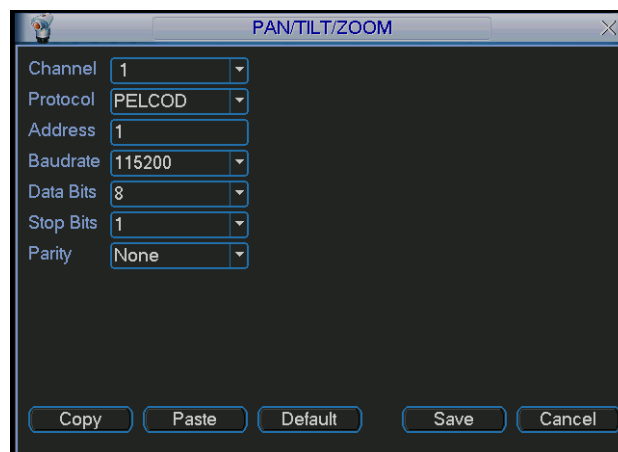

Figure 4-34

After completing all the settings click save button.

In one window display mode, right click mouse (click “Fn” Button in the front panel or click “Fn” key in the remote control). The interface shown in Figure 4-31 will be displayed.

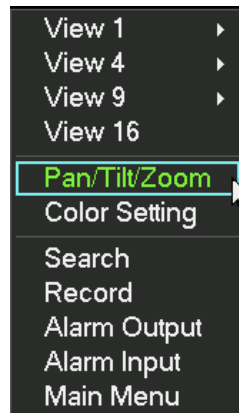

Figure 4-35

Click Pan/Tilt/Zoom, the interface below will be displayed. See Figure 4-35.

Here you can set the following items:

- Speed: value ranges from 1 to 8.
- Zoom
- Focus
- Iris



Please click icon  and  to adjust zoom, focus and iris.



Figure 4-36

In Figure 4-37, please click direction arrows to adjust PTZ position. There are total 8 direction arrows.



Figure 4-37

4.8.2.1 Intelligent Positioning Key













In the middle of the eight direction arrows, there is a 3D intelligent positioning key (see figure 4-38). This function only works if your protocol supports it, and you need to use mouse to control.

Click this key, system goes back to the single screen mode. Drag the mouse in the screen to adjust section size. The dragged zone supports 4X to 16X speeds. The function will work automatically. The smaller the zone you dragged, the higher the speed.



Figure 4-38

Here is a chart for your reference:

Name	Function key	function	Shortcut key	Function key	function	Shortcut Key
Zoom		Near			Far	
Focus		Near			Far	
Iris		close			Open	

4.9 Preset/ Patrol/Pattern/Scan

Click the “set” button illustrated in Figure 4-36. This will generate the interface shown in Figure 4-39.

Here you can set the following items:

- Preset
- Tour
- Pattern
- Border

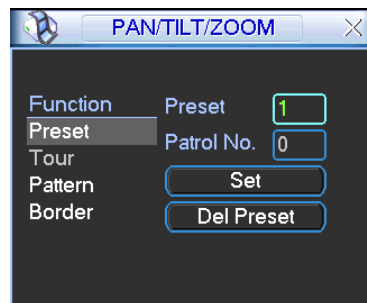

Figure 4-39

Click the page switch button illustrated in Figure 4-36. This will activate the following functions:

- Preset
- Tour
- Pattern
- Auto scan
- Auto pan
- Flip
- Reset
- Page switch

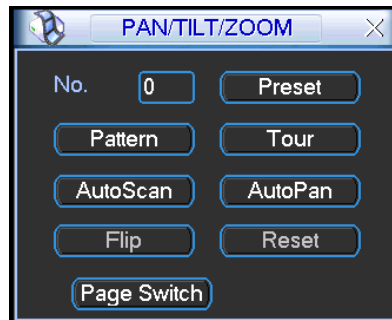

Figure 4-40

Note:

- Preset, tour and pattern all need the value to be the control parameter. You can define it as you require.
- You need to refer to your speed dome user's manual for Aux definition. In some cases, it can be used for special processes.
- The following setups are usually operated in Figure 4-36, Figure 4-37 and Figure 4-39.

4.9.1 Preset Setup

As shown in Figure 4-36, uses eight direction arrows to adjust camera to the proper position. Click the preset button and input preset number. The interface is shown in Figure 4-41.

Now you can add this preset to one tour.

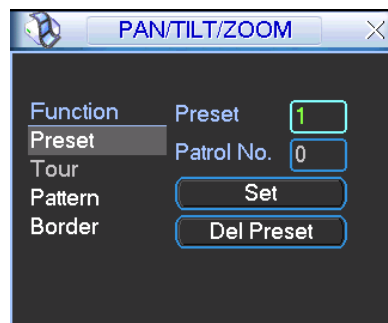

Figure 4-41

4.9.2 Activate Preset

As shown in Figure 4-39, input preset number in the blank, and click preset button.

4.9.3 Patrol setup (Tour Setup)

As shown in Figure 4-36, click the patrol button. The interface is shown in Figure 4-42. Input preset number and add this preset to a patrol (tour). For each patrol (tour), you can input up to 80 presets.



Figure 4-42

4.9.4 Activate Patrol (tour)

As shown in Figure 4-42, input patrol (tour) number in the blank and click patrol button

4.9.5 Pattern Setup

As shown in Figure 4-41, click pattern button and then click “begin” button. This will generate an interface as shown in Figure 4-43. Then you can go to the screen illustrated in Figure 4-36 to modify zoom, focus, and iris.

Go back to the screen illustrated in Figure 4-43 and click “end” button and save your changes as any pattern number you wish so that you can easily utilize them in the future.



Figure 4-43

4.9.6 Activate Pattern Function

As shown in Figure 4-43, input reference number in the Pattern field.

4.9.7 Auto Scan Setup

As shown in Figure 4-43, the border button to get to the interface shown in Figure 4-44. Choose from the options of Left or Right. Set the Left and Right border limits by going back to the screen illustrated in Figure 4-36.



Figure 4-44

4.9.8 Activate Auto Scan

As shown in Figure 4-36, click “Auto Scan” button to begin system auto scan. During scan the auto scan button becomes Stop button. Click stop button to terminate scan operation.

4.10 Flip

As shown in Figure 4-36, click the page switch button to get the interface illustrated in Figure 4-45. From here, you can set the auxiliary function. The aux value is relative to the Aux button of the camera.

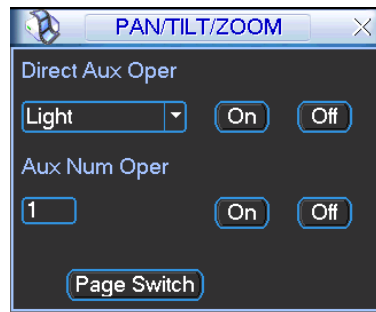
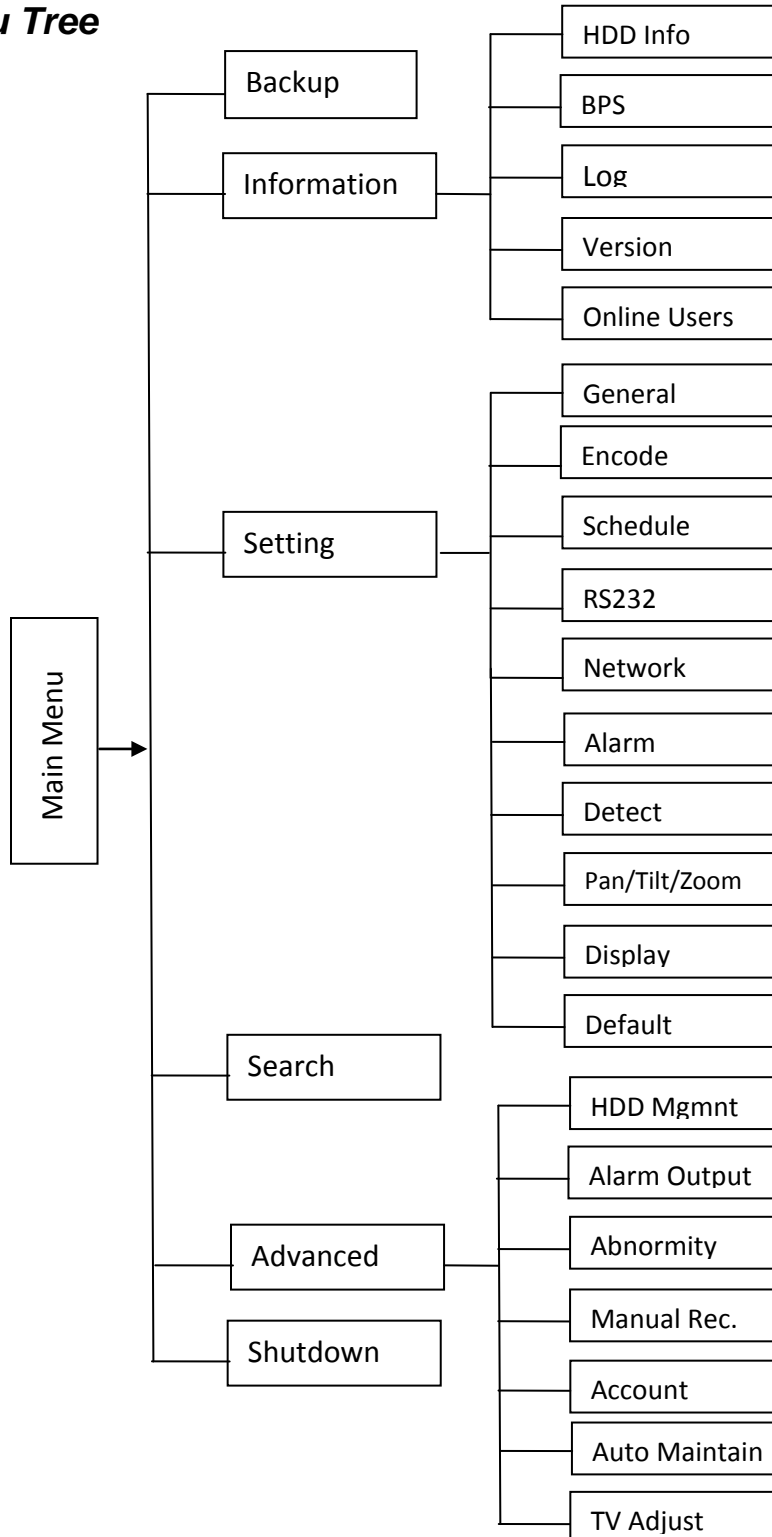

Figure 4-45

Please note the direction buttons are to control the speed dome menu. The button definition is defined by the speed dome protocol. The button becomes grey and invalid if current protocol does not support this function. The up/down button is to switch between the items and the left/right button is to modify the setup.

5. Understanding of Menu Operations and Controls

5.1 Menu Tree



5.2 Main Menu

After you log in, the system main menu is shown below in Figure 5-1. There are six icons: search, Information, setting, advanced, backup and shutdown. Move the cursor to highlight the icon, then double click mouse to enter the sub-menu.

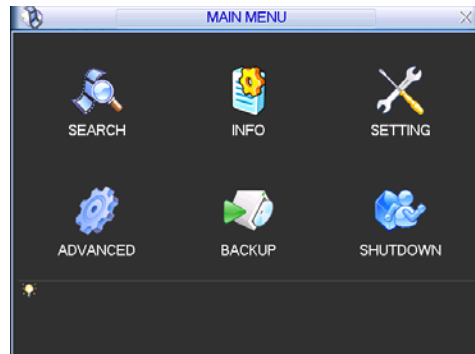

Figure 5-1

5.3 Setting

In main menu, highlight setting icon and double click mouse. System setting interface is shown below. See Figure 5-2.

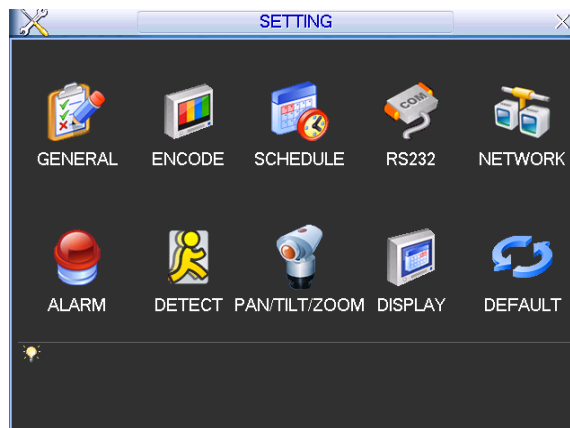

Figure 5-2

5.3.1 General

General setting includes the following items. See Figure 5-3.

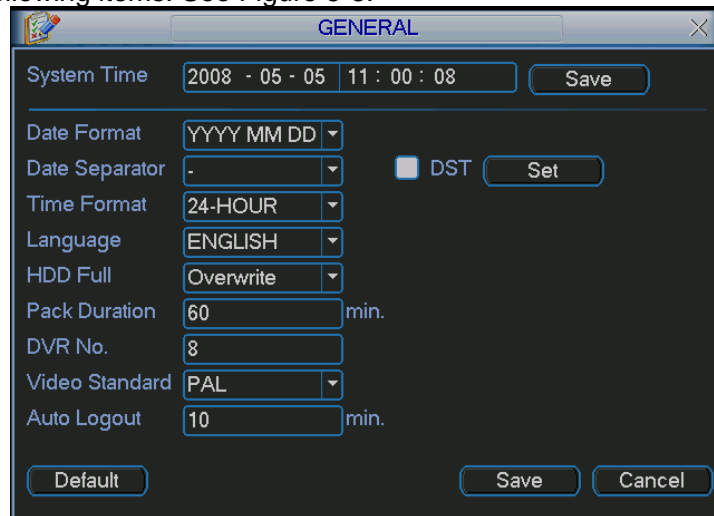

Figure 5-3

- System time: Here is where you set system time
- Date format: There are three types: YYYY-MM-DD: MM-DD-YYYYY or DD-MM-YYYY.
- Date separator: There are three options to separate date: dot, beeline and solidus.
- DST: Here you can set DST time and date. Enable DST function and then click set button. You will see an interface shown in Figure 5-4.

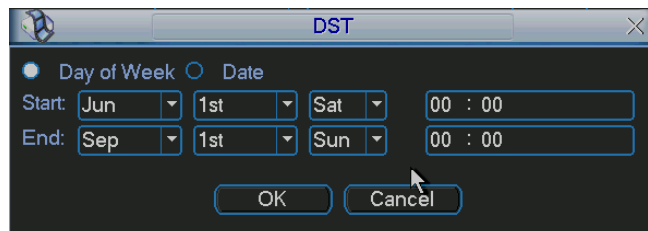

Figure 5-4

Here you can set start time and end time by setting corresponding week setup. In Figure 5-4, enable date button, you can see the interface shown in Figure 5-5. Here you can set start time and end time by setting corresponding date setup.

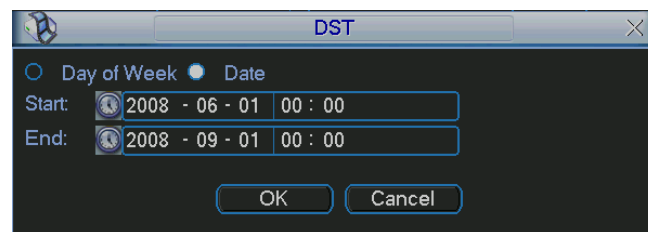

Figure 5-5

- Time format: There are two types: 24-hour mode or 12-hour mode.

- Language: System supports various languages: Chinese (simplified), Chinese (Traditional), English, Italian, Japanese, French, Spanish (All languages listed here are optional. Slight difference may be found in difference models.)
- HDD full: Here you can select what to do when hard drive becomes full. There are two options: stop recording or overwrite. If you select the overwrite option the system will overwrite the oldest files when it runs out of space. If you do not select this option it will stop recording.
- Pack duration: Here you can specify record length. The value ranges from 60 to 120 minutes. Default value is 60 minutes.
- DVR No: When you are using one remote control to control several DVRs, you can give a number to each DVR to make it easier to manage the units.
- Video standard: There are two formats: NTSC and PAL, in North America we use NTSC.
- Auto logout: Here you can set the unit to automatically log out when a user account remains inactive for a specified time. The value ranges from 0 to 60 minutes.

Note:

Since system time is very important, do not modify time unless there is a need to do so!

Before your time modification, stop recording first!

After completing all the setups please click save button, system goes back to the previous menu.

5.3.2 Encode

Encode setting includes the items listed below. See Figure 5-6.

Please highlight icon  to select the corresponding function.

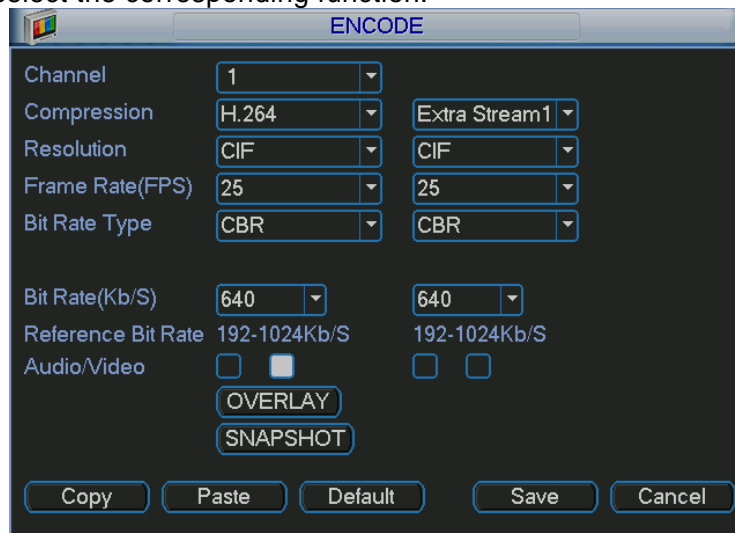

Figure 5-6

Channel: Select the channel you want.

- Compression: System supports H.264.
- Resolution: System supports various resolutions, you can select from the dropdown list. For this model, main stream supports D1/CIF/QCIF. Please note the resolution may vary due to different channels. The extra stream supports QCIF only.
- Frame rate: It ranges from 1f/s to 30f/s in NTSC mode and 1f/s to 25f/s in PAL mode.

Note:

If the 1-channel resolution is D1 and the frame rate is more than 6f/s, then the other seven channels (the second channel to the eighth channel) resolution shall be CIF or QCIF.

If the 1-channel resolution is D1 and the frame rate is or less than 6f/s, then the other seven channels (the second channel to the eighth channel) resolution shall be D1/CIF/QCIF. Right now in D1 resolution, the max frame rate is 6f/s on more than one channel.

- Bit rate type: System supports two types: CBR and VBR. In VBR mode, you can set video quality.
- Quality: There are six levels ranging from 1 to 6. The sixth level has the highest image quality.
- Video/audio: You can enable or disable the video/audio.
- Overlay: Click overlay button, you can see the interface shown in Figure 5-7

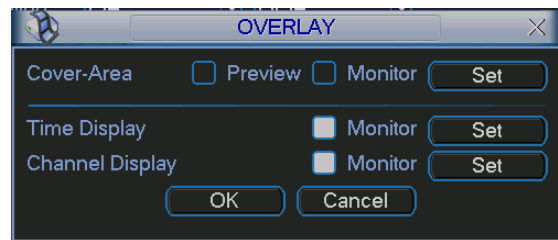

Figure 5-7

- ✧ Cover area (Privacy mask): Here you can set privacy mask sections. You can drag your mouse to set section size. In one channel video, system supports up to 4 zones.
- ✧ Preview/monitor: privacy mask has two types. Preview and Monitor. Preview means the privacy mask zone can not be viewed by user when system is in preview status. Monitor means the privacy mask zone can not be viewed by the user when system is in monitor status.
- ✧ Time display: You can select for the system to display time or not when you playback. Click set button and then drag the title to the corresponding position in the screen.
- ✧ Channel display: You can select whether system displays channel number or not when you playback. Click set button and then drag the title to the corresponding position in the screen.

5.3.3 Schedule

Please refer to chapter 4.4 schedule.

5.3.4 RS232

RS232 interface is shown below. There are five items. See Figure 5-8



Figure 5-8

- Function: There are various devices for you to select. Console is for serial port or min-end platform to upgrade program. Keyboard is for you to use special keyboard to control current device.
- Baud rate: You can select proper baud rate.
- Data bit: You can select proper data bit. The value ranges from 5 to 8.
- Stop bit: There are three values: 1/1.5/2.
- Parity: there are three choices: none/odd/even.

System default setup is:

- Function: Console
- Baud rate: 115200
- Data bit: 8
- Stop bit: 1
- Parity: None

After completing all setups click save button, system goes back to the previous menu.

5.3.5 Network

Here is where you input network information. See Figure 5-9.

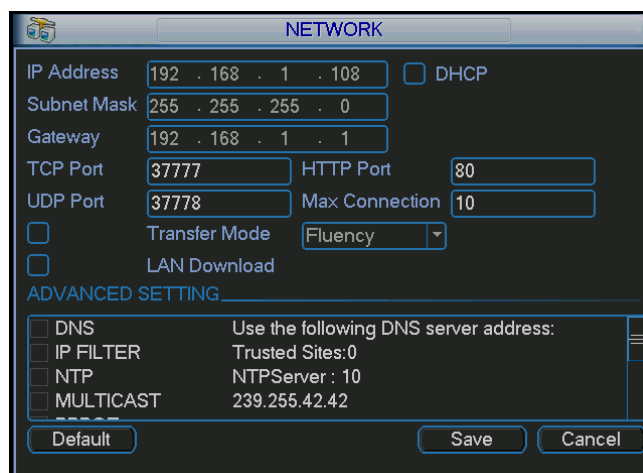
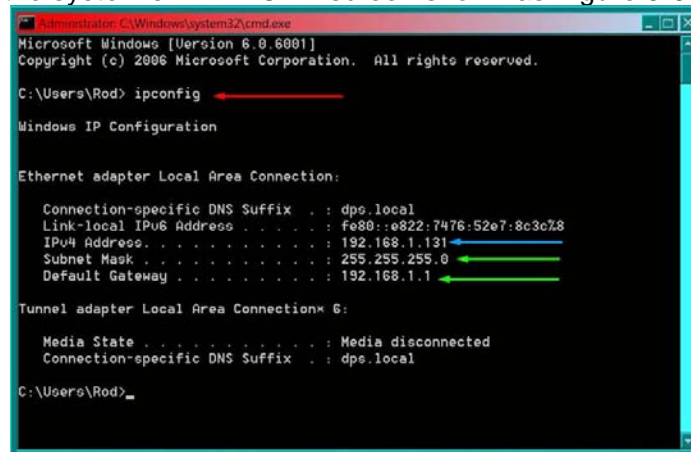

Figure 5-9

- DHCP: You use this option to have the router the DVR is attached to assign an IP address for you. When you enable the DHCP function, you can not modify IP/Subnet mask /Gateway. These values are assigned by the DHCP function in the router. If you have not enabled DHCP function, IP/Subnet mask/Gateway display is zero. You need to disable DHCP function to view current IP information. When PPPoE is operating, you can not modify IP/Subnet mask /Gateway.
- TCP port: Default value is 37777.
- UDP port: Default value is 37778.
- HTTP port: Default value is 80.
- IP address: Here you can input a static IP address.

You will need to setup the network settings on the DVR to match the settings of the router that you attach the DVR to. To get the router settings you would go to the run option on a computer attached to the same router as the DVR and type cmd and hit OK to bring up a command prompt (Figure 5-10), then type ipconfig at the prompt (RED arrow on Figure 5-10) to access the router settings. Write down the gateway and subnet mask numbers (GREEN arrows on Figure 5-10) so you can copy them into the network settings on the DVR. Use the MENU on the DVR to get to the system's NETWORK screen shown as Figure 5-9.



```

Administrator: C:\Windows\system32\cmd.exe
Microsoft Windows [Version 6.0.6001]
Copyright (c) 2006 Microsoft Corporation. All rights reserved.

C:\Users\Rod> ipconfig

Windows IP Configuration

Ethernet adapter Local Area Connection:

    Connection-specific DNS Suffix  . : dps.local
    Link-local IPv6 Address . . . . . : Fe80::e822:7476:52e7:8c3c%8
    IPv4 Address. . . . . : 192.168.1.131
    Subnet Mask . . . . . : 255.255.255.0
    Default Gateway . . . . . : 192.168.1.1

Tunnel adapter Local Area Connection* 6:

    Media State . . . . . : Media disconnected
    Connection-specific DNS Suffix  . : dps.local

C:\Users\Rod>
  
```

Figure 5-10

For the DVRs IP address you would enter the same first 3 sets of numbers as the gateway and select a fourth set of numbers that is different then any other device attached to the same router. If the IP address of your computer in the ipconfig (BLUE arrow in Figure 5-10) was a single or two digit number you should be ok with any three digit number, if the computer IP address ends with a number in the 100s then you should go with a 200 number. Enter the same Gateway and Subnet as the green arrows in ipconfig.

- Maximum connections: system supports up to 10 users. 0 means there is no connection limit.
- Transfer mode: Here you can select the priority between fluency/video qualities.
- LAN download: System can process the downloaded data first if you enable this function. The download speed is 1.5X or 2.0X of the normal speed.

After completing all the setups please click save button, system goes back to the previous menu.

5.3.5.1 Advanced Network Setup

Advanced setup interface is shown in Figure 5-11. Put a checkmark in the box to enable the corresponding function and then double click current item to go to setup interface.

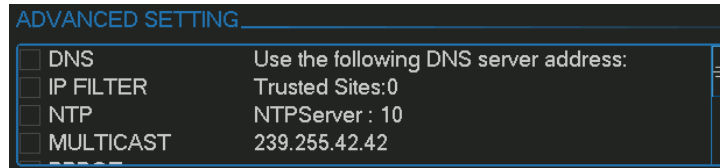

Figure 5-11

IP Filter

IP filter interface is shown in Figure 5-12. You can add IP in the following list. The list supports up to 64 IP addresses.

Please note after you enable this function, only the IPs listed below can access the DVR.

If you disable this function, all IP addresses can access the DVR.

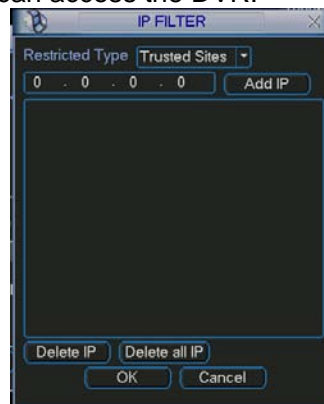

Figure 5-12

PPPoE

PPPoE interface is shown in Figure 5-13.

Input "PPPoE name" and "PPPoE password" you get from your ISP (Internet service provider).

Click save button, you need to restart to activate your configuration.

After rebooting, combo DVR will connect to internet automatically. The IP in the PPPoE is the combo DVR dynamic value. You can access this IP to access the unit.

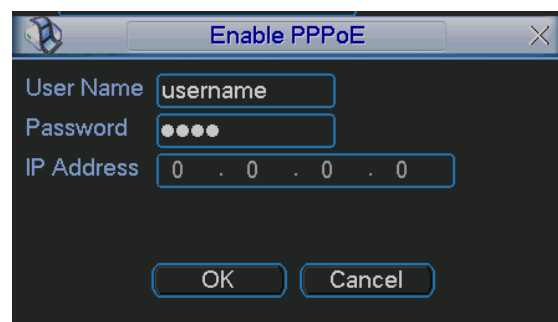

Figure 5-13

NTP Setup

You need to install SNTP server (Such as Absolute Time Server) in your PC first. In Windows XP you can use command “net start w32time” to boot up NTP service.

NTP setup interface is shown in Figure 5-14.

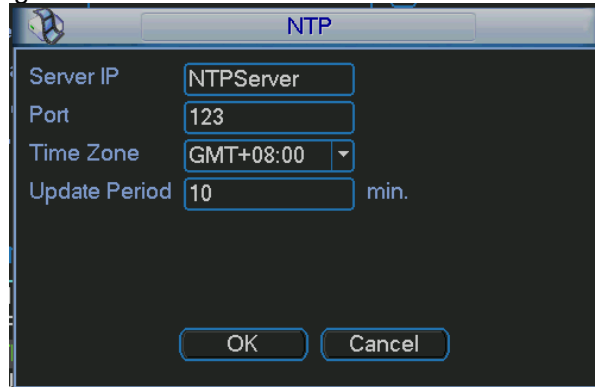

Figure 5-14

- Host IP: Input your PC address.
- Port: This combo DVR supports TCP transmission only. Port default value is 123.
- Update interval: minimum value is 1. Max value is 65535. (Unit: minutes)
- Time zone: select your corresponding time zone here.

City /Region Name	Time Zone
London	GMT+0
Berlin	GMT+1
Cairo	GMT+2
Moscow	GMT+3
New Deli	GMT+5
Bangkok	GMT+7
Beijing (Hong Kong)	GMT+8
Tokyo	GMT+9
Sydney	GMT+10
Hawaii	GMT-10
Alaska	GMT-9
Pacific Time(P.T)	GMT-8
American Mountain Time(M.T)	GMT-7
American Central Time(C.T)	GMT-6
American Eastern Time(E.T)	GMT-5
Atlantic Time	GMT-4
Brazil	GMT-3
Middle Atlantic Time	GMT-2

DDNS Setup

DDNS setup interface is shown in Figure 5-15.

In network DDNS, please select DDNS type and highlight enable item. Then please input the Host name and Password you setup on the DDNS site where you created your account. Click save button and then reboot system. Click save button, system prompts for rebooting to get all setup activated.

After rebooting, open IE and input as below:

http : //(DDNS server IP)/(virtual directory name)/webtest.htm

e.g.: http : //10.6.2.85/ combo DVR _DDNS/webtest.htm.)

Now you can open DDNS Server web search page.



Figure 5-15

Please note DDNS type includes: MYQ-SEE DDNS, DYNDNS DDNS, and NO-IP DDNS. All DDNS can be valid at the same time, you can select as you need.

Please refer to chapter 9 for MYQ-SEE setup information.

DNS

There are two modes: Manual setup and auto setup

- Manual Setup

You can double click DNS to set DNS address manually. See Figure 5-16.

Please input preferred DNS server IP and alternative DNS server IP.

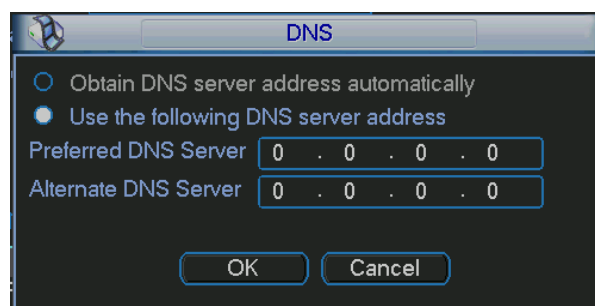

Figure 5-16

- Auto gets DNS address

Please enable DHCP function first and then double click DNS item.

If the DHCP function is enabled successfully, system can get the DNS server IP address. See Figure 5-17.

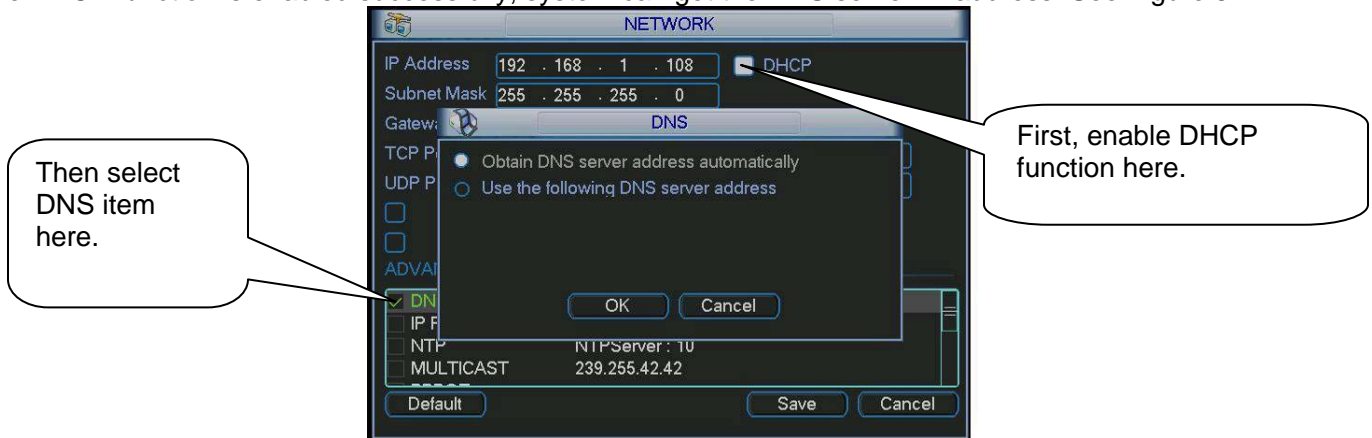

Figure 5-17

FTP

You need to download or buy a FTP service tool (such as Ser-U FTP SERVER) to establish FTP service.

Install Ser-U FTP SERVER first. From "start" -> "program" -> Serv-U FTP Server -> Serv-U Administrator. Now you can set user password and FTP folder. Please note you need to grant write rights to FTP upload user. See Figure 5-18.

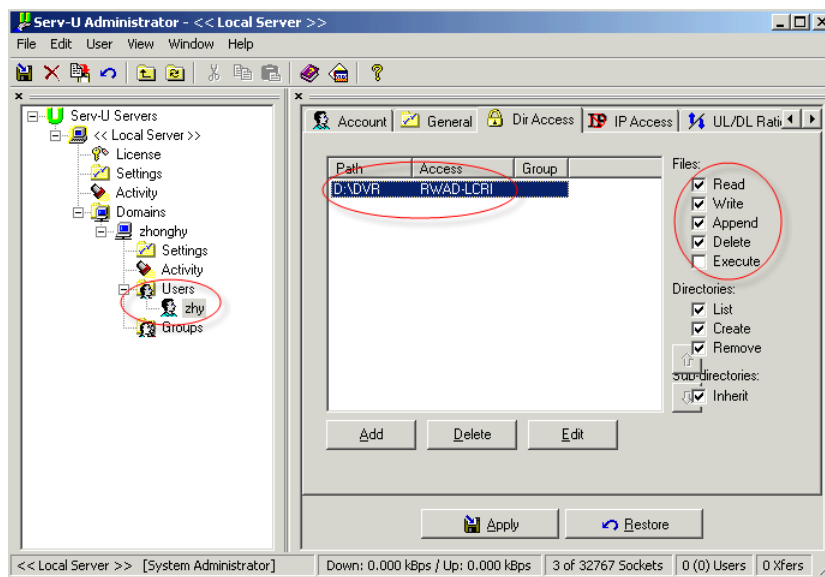

Figure 5-18

You can use a PC or FTP login tool to test to see if setup is right or not.

For example, you can login user ZHY to [FTP://10.10.7.7](ftp://10.10.7.7) and then test if user can modify or delete folder or not.

See Figure 5-19.

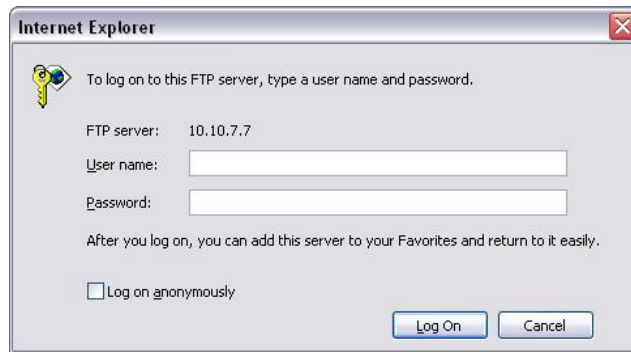

Figure 5-19

System also supports uploading multiple DVRs to one FTP server. You can create multiple folders under this FTP. In Figure 5-9, select FTP and then double click mouse. You will see the following interface. See Figure 5-20.

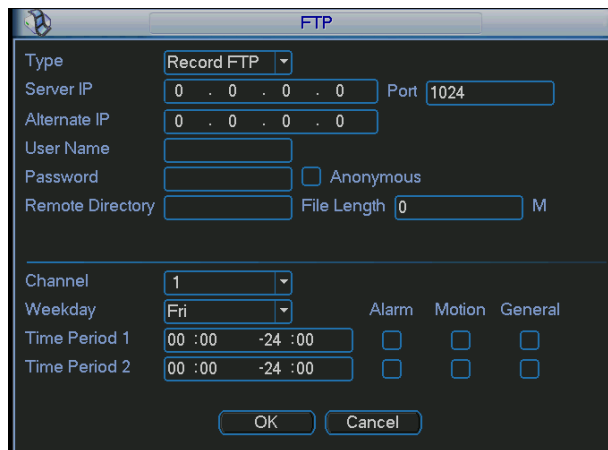



Figure 5-20

Please highlight the icon  in front of Enable to activate FTP function. Here you can input FTP server address, port and remote directory. When remote directory is empty, system will automatically create folders according to the IP, time and channel. User name and password is the account information for you to login to the FTP. File length is upload file length. When setup is larger than the actual file length, system will upload the whole file. When setup here is smaller than the actual file length, system only uploads the set length and automatically ignores the left section. When interval value is 0, system uploads all corresponding files. After completing channel and weekday setup, you can set two periods for one each channel.

Email

The email interface is shown below. See Figure 5-21.

- SMTP server: Input your email SMTP server IP here.
- Port: Input corresponding port value here.
- User name: Input the user name to login the sender email box.
- Password: Input the corresponding password here.
- Sender: Input sender email box here.
- Title: Input email subject here. System supports letters and numbers. Max 32-digit.
- Receiver: Input receiver email address here. System supports up to 3 email boxes.
- SSL enable: System supports SSL encryption box.
- Interval: The send interval ranges from 0 to 3600 seconds. 0 means there is no interval.

Please note system will not send out the email immediately when the alarm occurs. When the alarm, motion detection or the abnormality event activates the email, system sends out the email according to the interval you specify here. This function is very useful when there are too many emails activated by the abnormality events, which may result in heavy load for the email server.

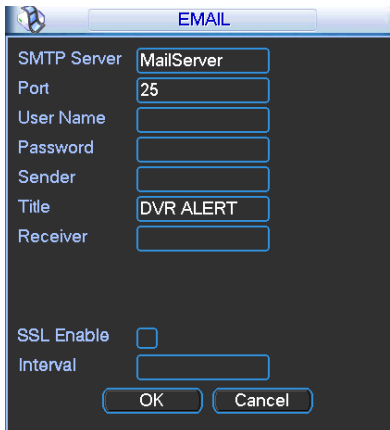

Figure 5-21

5.3.6 Alarm

Please refer to Chapter 4.6 Alarm Setup and Activation.

5.3.7 Detect

Please refer to Chapter 4.5 Detect.

5.3.8 Pan/Tilt/Zoom

The pan/tilt/zoom setup includes the following items. Please select channel first. See Figure 5-22.

- Protocol: Select corresponding PTZ protocol such as PELCOD.
- Address: input corresponding PTZ address.
- Baud rate: Select baud rate.
- Data bit: Select data bit.
- Stop bit: Select stop bit.
- Parity: There are three choices: none/odd/even.

After completing the setup click save button, system goes back to the previous menu.

For detailed setup, please refer to Chapter 4.9 preset/patrol/pattern/scan.

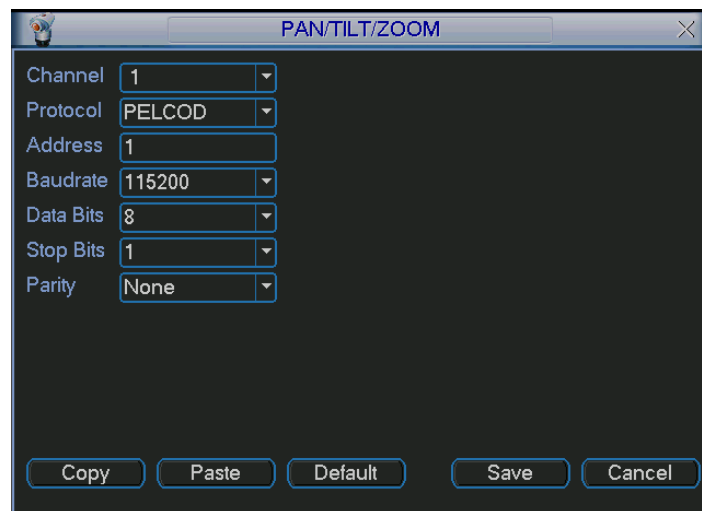



Figure 5-22

5.3.9 Display

Display setup interface is shown below. See Figure 5-23.

- Transparency: Here you can adjust transparency. The value ranges from 128 to 255.
- Channel name: Here you can modify channel name. System supports up to 25-digits. Please note all your modifications here only apply to combo DVR local end. You need to open web or client end to refresh channel name.
- Time display: You can select to display time or not when system is playing back.
- Channel display: You can select to display channel name or not when system is playing back.
- Overlay information: System displays some information on the screen for your reference.
- Resolution: There are five options: 1400x900(default), 1280x1024, 1280x720, 1024x768, 800x600. Please note the device needs to reboot to activate setup changes.
- Display mode: You can select from the dropdown list.
- Enable tour: Activate tour function.
- Interval: Input proper interval value here. The value ranges from 5-120 seconds. In tour process, you can use mouse or click Shift to turn on window switch function.  Stands for opening switch function,  stands for closing switch function.
- Motion tour type: System supports 1/8 window tour.
- Alarm tour type: System supports 1/4/9/16 window tour.

Please highlight icon  to select the corresponding function.

After completing the setup click save button, system goes back to the previous menu.

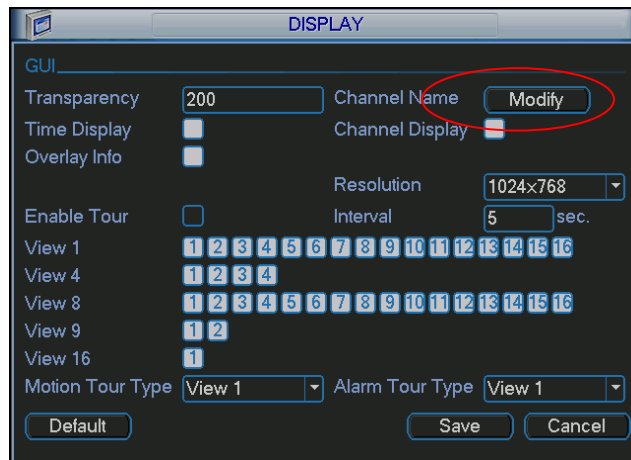

Figure 5-23

In Figure 5-23, click modify button after channel. You will see the interface shown in Figure 5-24. Please note all your modifications here apply to local end only. You need to refresh web or client-end to get the latest channel name. System supports up to 25-digital characters.

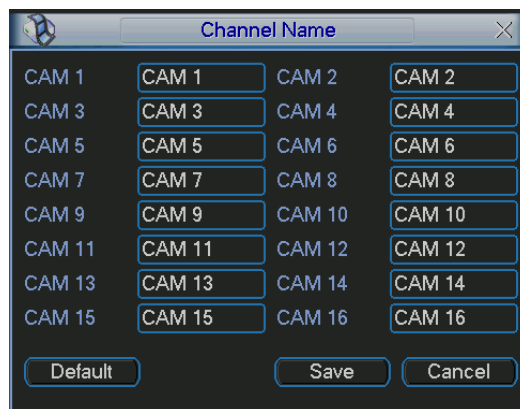

Figure 5-24



In tour mode, you will see the following interface. On the right corner, right click mouse or click shift button, you can control the tour. There are two icons:  stands for enabling window switch mode and  stands for stopping window switch function. See Figure 5-25.



Figure 5-25

5.3.10 Default

Click default icon, system pops up a dialogue box. You can highlight  to restore default factory setup. See Figure 5-26.

- Select all
- General
- Encode
- Schedule
- RS232
- Network
- Alarm
- Detect
- Pan/tilt/zoom
- Display
- Channel name

Please highlight icon  to select the corresponding function.

After all the setups please click save button, system goes back to the previous menu.

Warning!

System menu color, language, time display mode, video format, IP address, user account will not retain previous setup after default operation!

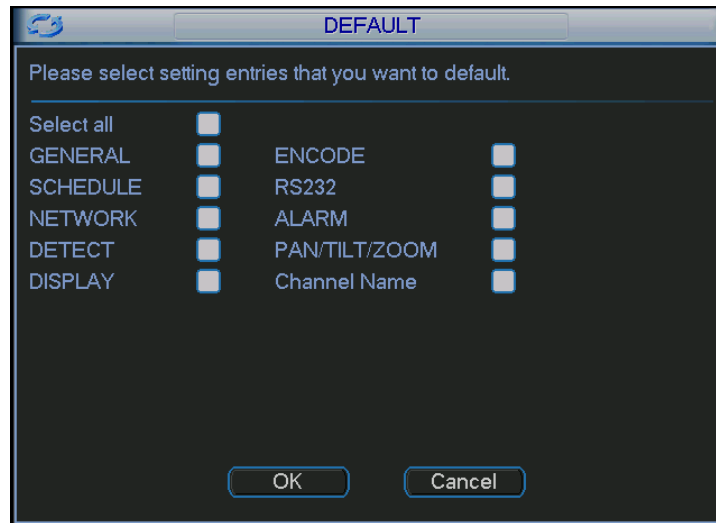

Figure 5-26

5.4 Search

Please refer to Chapter 4.3 Search.

5.5 Advanced

Double click advanced icon in the main window, the interface is shown below. See Figure 5-27. There are seven function keys: HDD management, alarm output, abnormality, manual record, account, auto maintenance, and TV adjust.



Figure 5-27

5.5.1 HDD Management

Here you can view and implement hard disk management. See Figure 5-28.

You can see current hard drive type, status, capacity and record time. When hard drive is working properly, system is shown as O. When hard drive error occurs, system is shown as X.

You can select hard drive mode from the dropdown list such as read-only or you can erase all data in the hard drive.

Note: system needs to reboot to get all the modifications activated.

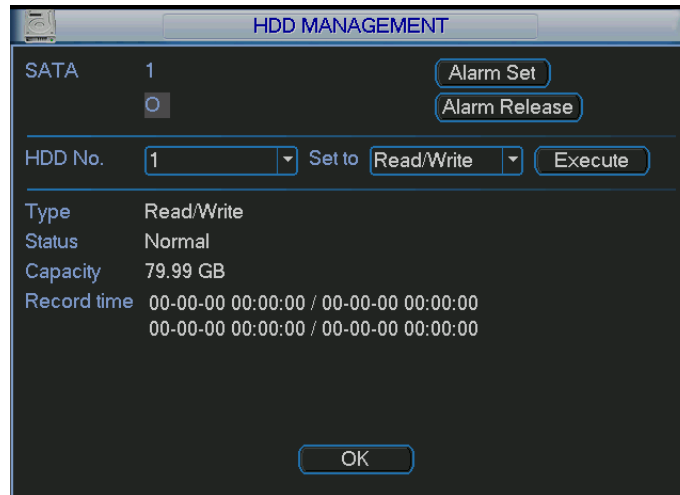



Figure 5-28

Click alarm set button, the interface is shown below. See Figure 5-29 (This interface is just like the abnormality setup). Please refer to Chapter 5.5.2 for detailed information.

Highlight icon  to select the corresponding function.

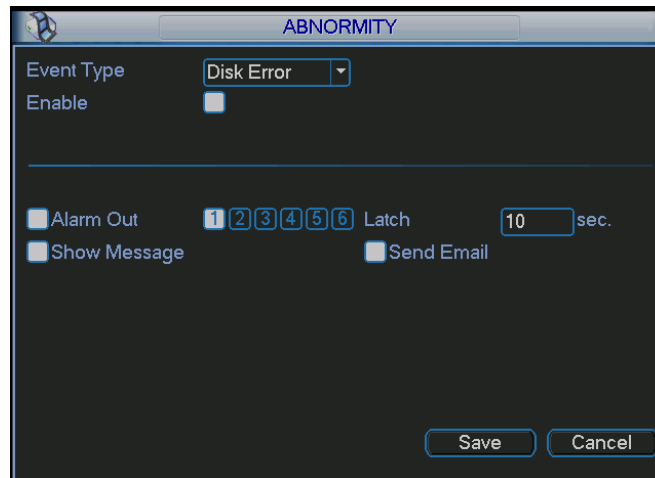

Figure 5-29

5.5.2 Abnormity

Abnormity interface is shown in Figure 5-30.

- Event type: There are several options such as disk error, no disk, disconnection, IP conflict etc.
- Alarm output: Select alarm activation output port (multiple choices).
- Latch: Here you set corresponding delaying time. The value ranges from 10s-300s. System automatically delays the number of seconds you specify before turning off alarm and de-activating output after external alarm ends.
- Show message: system can display the message in the local screen to alert you when alarm occurs.
- Alarm upload: System can upload the alarm signal to the network (including alarm center) if you enable this function.
- Send email: System can send out email to alert you when alarm occurs.

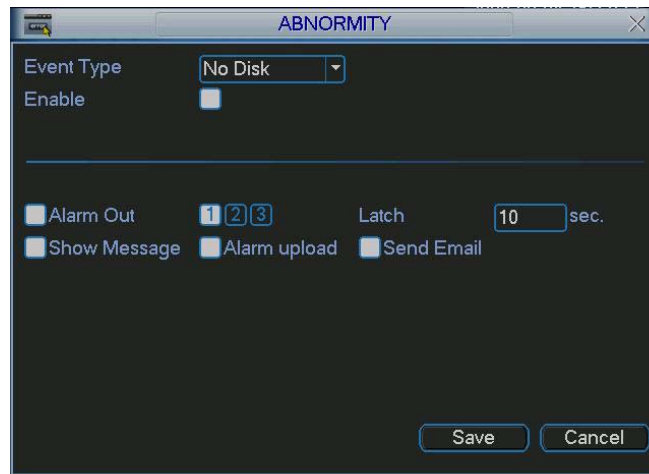



Figure 5-30

5.5.3 Alarm Output

Here is where you set proper alarm output.

Please highlight icon  to select the corresponding alarm output. After completing the setups please click OK button, system goes back to the previous menu. See Figure 5-31.

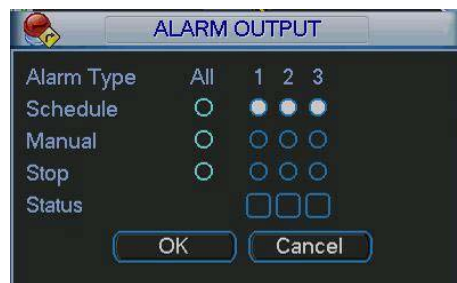

Figure 5-31

5.5.4 Manual Record

Please refer to Chapter 4.2.2 manual record.

5.5.5 Account

Here you setup account management. See Figure 5-32.

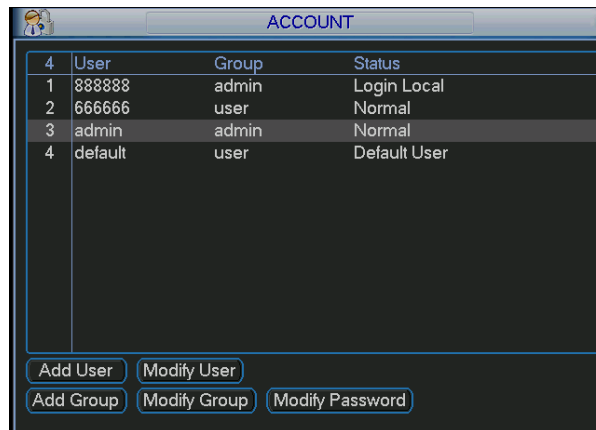

Figure 5-32

Here you can:

- Add new users
- Modify users
- Add groups
- Modify groups
- Modify passwords.

For account management please note:

- System account adopts two-level management: group and user. No limit to group or user amounts.
- For group or user management, there are two levels: admin and user.
- The user name and group name can consist of eight bytes. A name can only be used once. There are three default users: admin/888888/666666. Except user 666666, other users have administrator right.
- One user should belong to one group. User rights can not exceed group rights.
- About reusable function: this function allows multiple users use the same account to login.

After the setup is complete click save button, system goes back to the previous menu.

5.5.6 Auto Maintain

Here you can set auto-reboot time and auto-delete old files setup. See Figure 5-33. You can select proper setup from dropdown list. After the setup is complete click save button, system goes back to the previous menu.

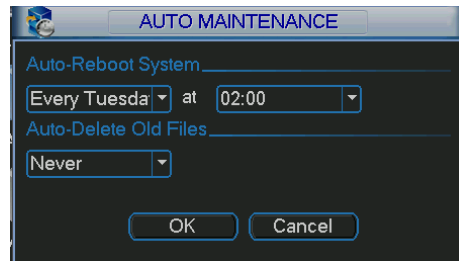

Figure 5-33

5.5.7 TV Adjust

Here you can adjust TV output setup. See Figure 5-34. Please drag slide bar to adjust each item. After the setup is complete click OK button, system goes back to the previous menu.



Figure 5-34

5.6 Information

Here you can view system information. There are five items: HDD (hard disk information), BPS (data stream statistics), Log, version, and online user. See Figure 5-35.

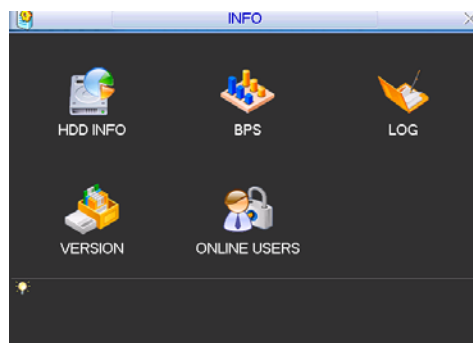

Figure 5-35

5.6.1 HDD Information

Here is listed hard drive type, total space, free space, video start time and status. See Figure 5-36.

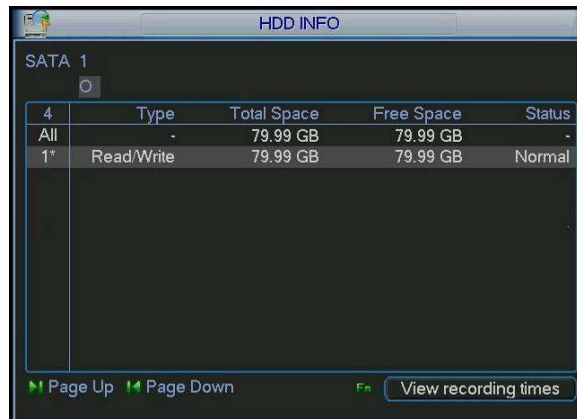

Figure 5-36

“o” means current HDD is normal. “X” means there is an error. “-“ means there is no HDD.

If disk is damaged, system shows a “?”. Please remove the damaged hard drive before you add a new one.

If there is a hard drive problem, check if hard drive time and system time correspond. Please go to setting then general to modify system time, then reboot the system to solve this problem.

After system boots up, if there is any problem, system goes to HDD information interface directly. Please note, system does not ask you to force a solution.

When HDD problem occurs, you can check to see if system time and HDD time are identical or not. If they are not identical, please go to General (Chapter 5.3.1) to adjust system time or go to HDD Management (Chapter 5.5.1) to format HDD and then reboot the combo DVR.

Tips:

Please click Fn button or left click mouse to view HDD record time and HDD type and time.

5.6.2 BPS

Here is where you view current video data stream (KB/s) and occupied hard drive storage (MB/h). See Figure 5-37.

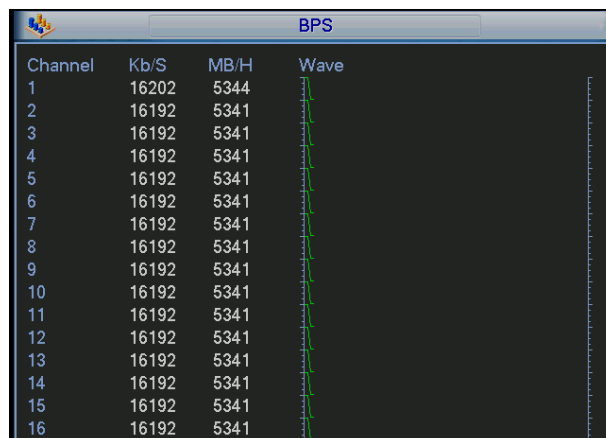

Figure 5-37

5.6.3 Log

Here you can view the system log file. See Figure 5-38.

Log types include system operation, configuration operation, data management, alarm event, record operation, log clear etc.

Select start time and end time, then click search button. You can view the log files. Use page up/down button to view if there are more than ten files.

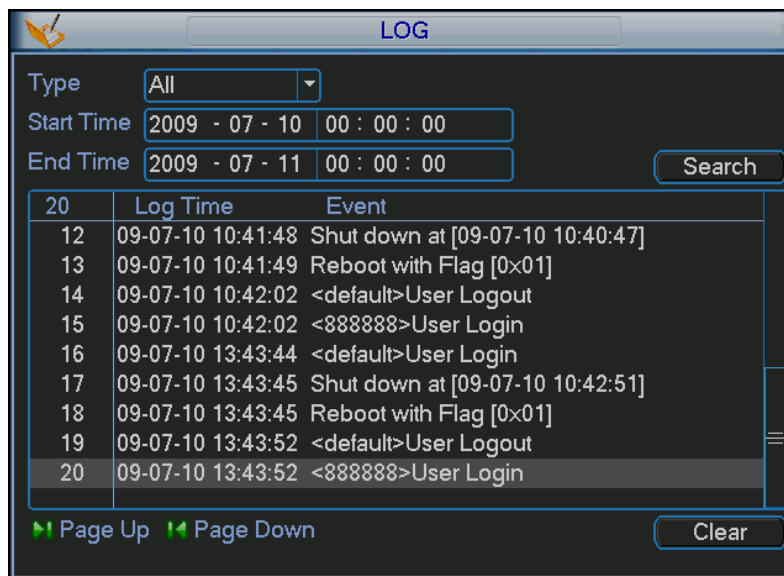

Figure 5-38

5.6.4 Version

Here you can view version information. See Figure 5-39.

- Channel
- Alarm in
- Alarm out
- System version:
- Build Date

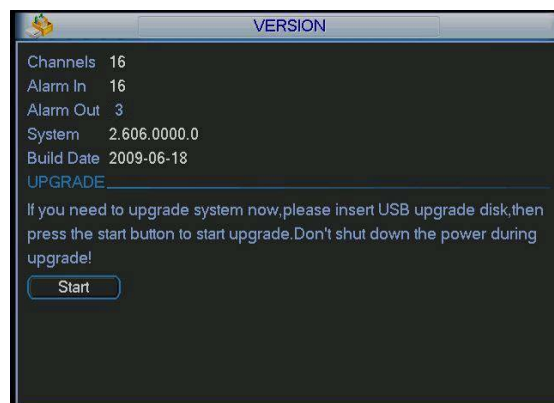

Figure 5-39

5.6.5 Online Users

Here you can manage online users. See Figure 5-40.

You can disconnect a user or block a user if you have proper system rights. Maximum disconnection setup is 65535 seconds.



Figure 5-40

5.7 Shutdown

Double click shutdown icon, system displays a dialogue box for you to select. See Figure 5-41.

- Logout menu user: You need to input password when you login the next time.
- Restart application: Reboot combo DVR.
- Shutdown: System shuts down and turns off power.
- Restart system: System reboots.
- Switch user: you can use another account to log in.

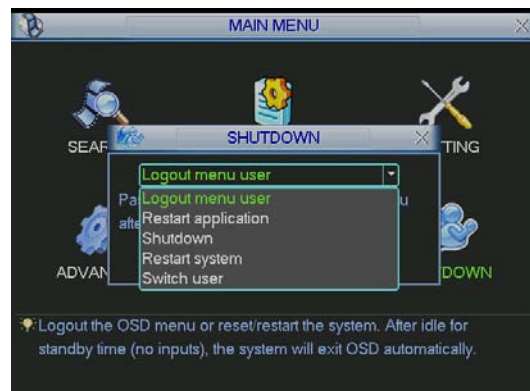

Figure 5-41

6. Auxiliary Menu

6.1 Go to Pan/Tilt/Zoom Menu

In the one-window surveillance mode, right click mouse (click “fn” Button on the front panel or click AUX key in the remote control). The interface shown below will be displayed: See Figure 6-1.



Figure 6-1.

Click Pan/Tilt/Zoom, the interface below will display. See Figure 6-2.
Here you can set the following items:

- Zoom
- Focus
- Iris



Please click icon  and  to adjust zoom, focus and Iris.



Figure 6-2.

In Figure 6-2, click direction arrows (See Figure 6-3) to adjust PTZ position. There are eight direction arrows. (Please note there are only four direction arrows in combo DVR front panel.)



Figure 6-3







6.2 Intelligent Positioning Key

In the middle of the eight direction arrows, there is a 3D intelligent positioning key. See Figure 6-4 . Please make sure your protocol supports this function and you need to use mouse to control. Click this button, system goes back to the single screen mode. Drag the mouse in the screen to adjust section size.



Figure 6-4

Here is a chart for your reference:

Name	Function key	function	Shortcut key	Function key	function	Shortcut key
Zoom		Near	▶		Far	▶▶
Focus		Near	◀		Far	▶
Iris		close	◀		Open	▶

6.3 Preset / Patrol / Pattern / Border Function

In Figure 6-2 click the set button. The interface is shown below:

Here you can set the following items:

- Preset
- Patrol
- Pattern
- Border



Figure 6-5

In Figure 6-2, click page switch button, you will see the interface in Figure 6-6.

Here you can activate the following functions:

- Preset
- Tour (Patrol)
- Pattern
- Auto scan
- Auto pan
- Flip
- Page Switch

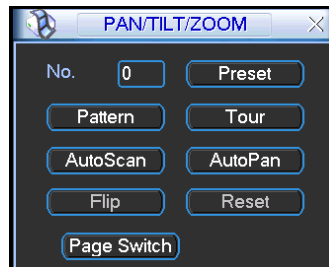

Figure 6-6

6.3.1 Preset Setup

Note: The following setups are usually operated in Figure 6-2, Figure 6-5 and Figure 6-6. In Figure 6-2, use eight direction arrows to adjust camera to the proper position. In Figure 6-5, click preset button and input preset number. The interface is shown in Figure 6-7. Add this preset to one patrol number



Figure 6-7

6.3.2 Activate Preset

In Figure 6-6 please input preset number in the blank, and click preset button.

6.3.3 Patrol Setup

In Figure 6-5, click patrol button. The interface is shown in Figure 6-8. Input preset number and then add this preset to one patrol.



Figure 6-8

6.3.4 Activate Patrol

In Figure 6-6, input patrol number in the blank and click patrol button

6.3.5 Pattern Setup

In Figure 6-5, click pattern button and then click begin button. The interface shows like Figure 6-9. Please go to Figure 6-2 to modify zoom, focus, and iris. Go back to Figure 6-9 and click end button. You can store all these setups as pattern 1.



Figure 6-9

6.3.6 Activate Pattern Function

In Figure 6-6 input mode value in the No. blank, and click pattern button.

6.3.7 Border Setup

In Figure 6-5, click border button. The interface is shown in Figure 6-10.

Please go to Figure 6-2, use direction arrows to select camera left limit, and then please go to Figure 6-10 and click left limit button

Repeat the above procedure to set right limit.



Figure 6-10

6.3.8 Activate Border Function

In Figure 6-6, click auto scan button, the system begins auto scan. Correspondingly, the auto scan button changes to stop button.

Click stop button to terminate scan operation.

6.3.9 Flip

In Figure 6-6, click page switch button, you will see the interface shown below. See Figure 6-11. Here you can set auxiliary function.

Click page switch button again, system goes back to Figure 6-2.

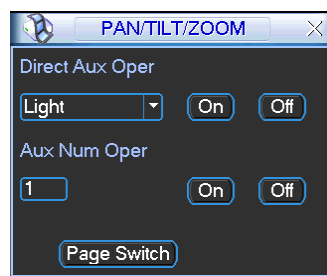

Figure 6-11

7 WEB OPERATION

7.1 Network Connection

BEFORE YOU CAN ACCESS THE DVR REMOTELY YOU NEED TO SETUP THE NETWORK CONFIGURATION ON THE DVR TO WORK WITH YOUR ROUTER. PLEASE REFER TO CHAPTER 5 - 5.5.3 Network

Before web operation, please check the following items:

- Network connection is right
- Combo DVR and PC network setup is right. Please refer to network setup (main menu->setting->network)
- Use order ping ***.***.***.***(* combo DVR IP address) to check connection is OK or not. Usually the return TTL value should be less than 255.
- Open the IE and then input combo DVR IP address.
- System can automatically download latest web control and the new version can overwrite the previous one.
- If you want to un-install the web control, please run *uninstall webrec2.0.bat*. Or you can go to C:\Program Files\webrec to remove single folder. Please note, before you un-install, please close all web pages, otherwise the un-installation might result in error.

7.1.1 Port Forwarding

To access the DVR from a remote computer over the internet you will need to forward port 80 and port 37777 of the Router the DVR is attached to, to the IP address of the DVR. You can get instructions on how to do this for most popular routers by going to www.portforward.com. Once there, click on the orange “Routers” link in the second paragraph as shown in Figure 7-1. Find the link of the brand and model of your router from the list of manufacturers and click the “next button”. From there, click on the orange “Default Guide” link (BLUE box in Figure 7-2). This will take you to the port forwarding instructions for your router.

When you access the DVR from a remote computer you also need to use a different address in the Internet Explorer browser window. Instead of entering the IP address of the DVR you need to enter the public IP address of the router the DVR is attached to. You can get this address by going to www.myipaddress.com from a computer that is attached to the same router as the DVR. This website will display your address as illustrated in Figure 7-3. The example below shows an IP Address of 76.254.183.54. Please make sure to take note of the address that you obtain for your own Router and use it accordingly.



Figure 7-1

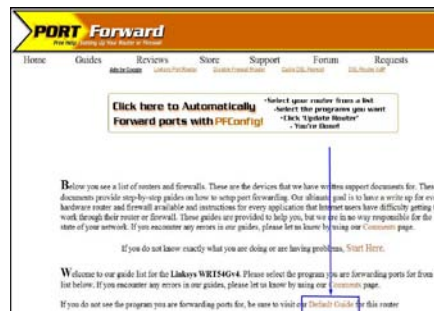

Figure 7-2



Figure 7-3

NOTE: If you cannot use HTTP port 80 or 37777 because it is being used by another program, or it is being blocked by your service provider, you can use another port in the same range. If you do so then you need to forward the IP address of the router to the other port, change the port in the DVR NETWORK settings and you need to add the port number after the IP address. For example, if you set the HTTP port as 82, you need to enter the IP address as xxx.xxx.xxx.xxx:82. Where the Xs are the numbers of the IP address you received from www.myipaddress.com

User name and password here are the same as what you use on the DVR.

7.1.2 Pop-Ups and ActiveX Controls

To access the DVR through Internet Explorer after you have configured your network settings on your DVR to match the settings of your Router and forwarded your ports as discussed above, you will need to modify your browser controls to allow Pop-ups. To do this, go to the Internet Explorer tool bar and select the "tools" option (RED box in Figure 7-4), then select the "Pop up Blocker" option and select "Turn Off Pop-up Blocker" (BLUE arrows in Figure 7-4). You will also need to enable Active X controls. To do this, go to the Internet Explorer tool bar and select the "tools" option, then "Internet Options"(GREEN arrow in Figure 7-4). This will open an Internet Options dialog box as shown in Figure 7-5. Through here, choose the "Security" tab (RED box in Figure 7-5), then click the "Custom Level" button (GREEN box in Figure 7-5), then click on OK (BLUE arrow in Figure 7-5). This will open a dialog box as shown in Figure 7-6. Once here, scroll down to the ActiveX Controls and Plug Ins and make sure they are all set to either prompt (BLUE arrows Figure 7-6) or enabled (RED arrows Figure 7-6).



Figure 7-4

To connect to the DVR from the remote computer you would then open an Internet Explorer browser window and enter the internet IP of your router that you got by going to www.myipaddress.com.

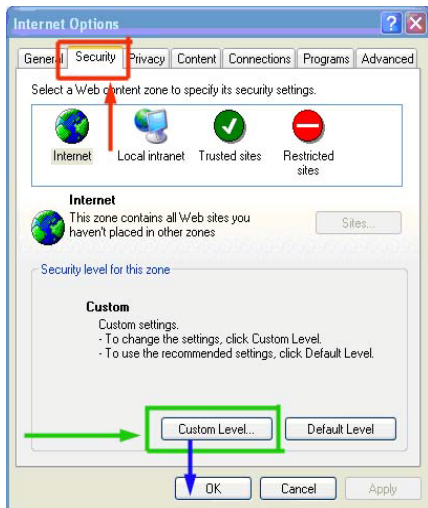

Figure 7-5

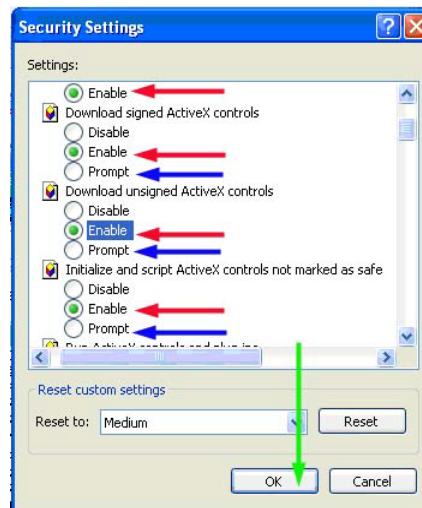

Figure 7-6

If you get a error message that says the program cannot load because the publisher is unknown or the program is unsigned, go to internet explorer→Tools→Internet Options (see Figure 7-4), then go to the “Advanced” tab (RED box in Figure 7-7). This will open the window in Figure 7-8. Scroll down to “Security”, and select the options to “Allow software to run or install even if the signature is invalid”, and “Allow Active Content to Run Files on My Computer” (RED box in Figure 7-8).

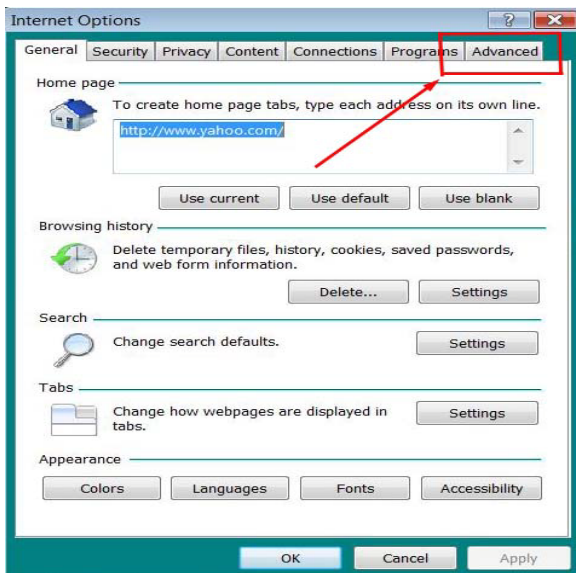

Figure 7-7

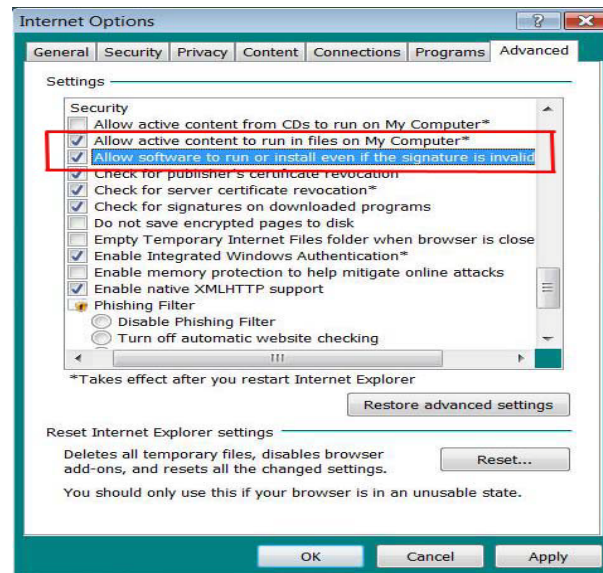

Figure 7-8

Other plug-ins or anti-virus programs may be blocking ActiveX. Please uninstall or close them
 NOTE: On many systems you many have another option. You can go into internet options in Internet Explorer, enter the IP address you use to access the DVR as a trusted site, then go to the default level button and set move the bar down to the low setting, click apply and ok. Do not select the option to enable protected mode or require server verification. On Vista you may get an “unknown publisher or publisher can’t be verified” error message. If you get one of these messages you need to go to the advanced tab, down to the security settings, put checkmarks in the options to allow active content to run on my computer, and allow software to run or install even if the signature is invalid, and remove the check for the option to check for signatures on downloaded programs.

7.2 Login

Open IE and input combo DVR address in the address column. For example, if your combo DVR IP is 10.10.3.16, then please input `http:// 10.10.3.16` in IE address column. If you are accessing the DVR from a computer that is attached to the same router as the DVR you would enter the IP address of the DVR. If you are accessing the DVR from a remote computer you would enter the public IP address of the router. You can get this address go going to a website such as www.myipaddress.com from a computer that is attached to the router as the DVR. See Figure 7-9

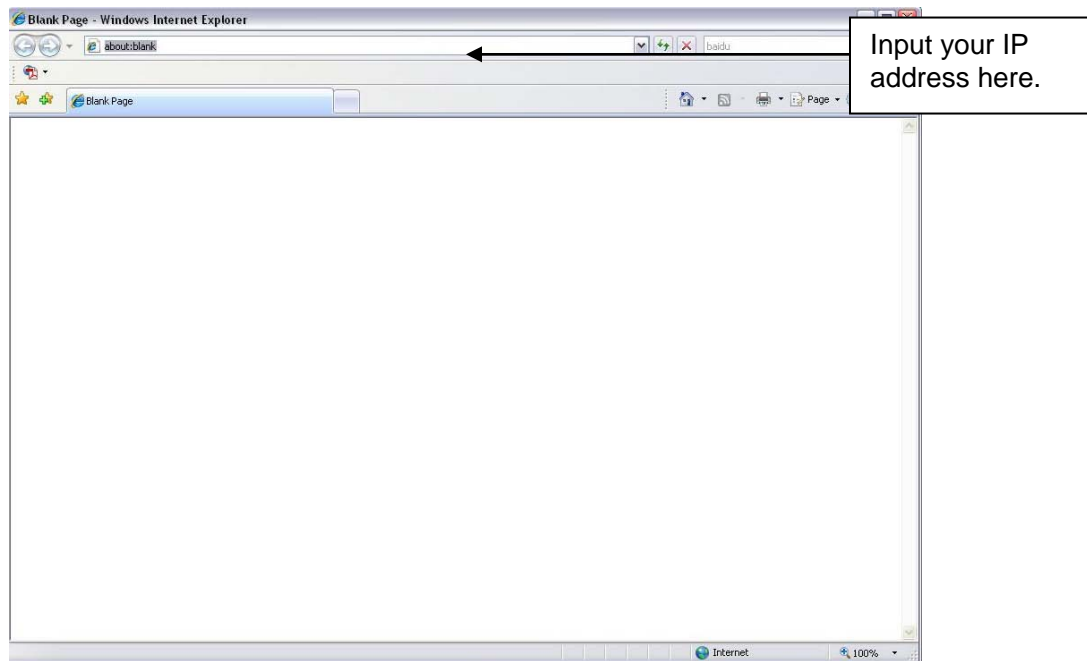

Figure 7-9

System pops up warning information to ask you whether install webrec.cab control or not. Please click yes button. After installation, the interface is shown below. See Figure 7-10.

Please input your user name and password.

Default factory name is admin and password is admin.

Note: For security reasons, please modify your password after you first login.

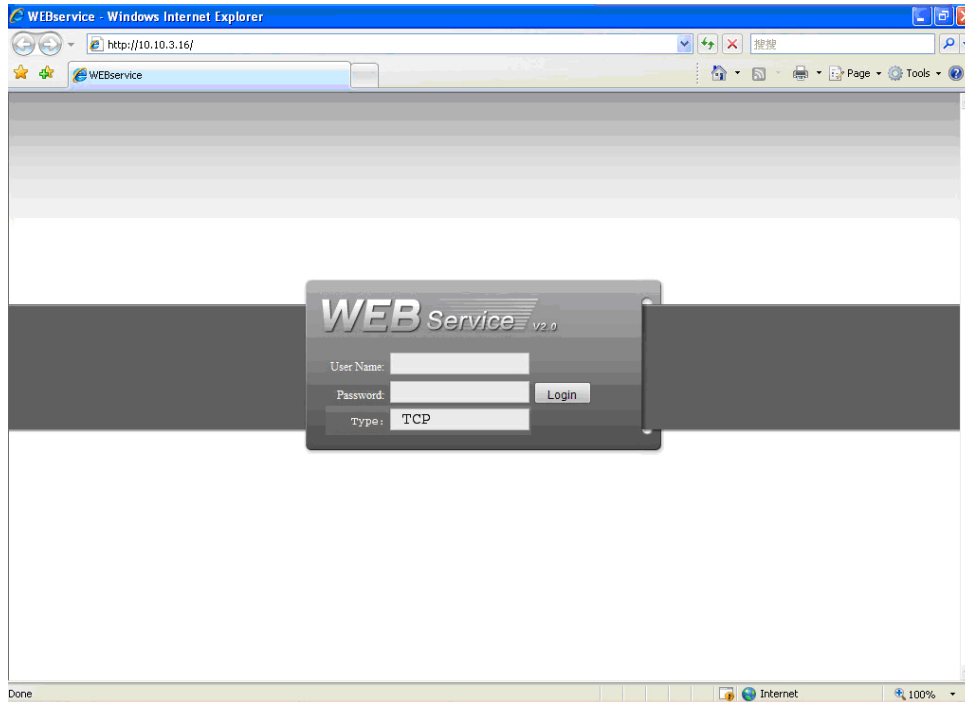

Figure 7-10

After you log in, you can see the main window. See Figure 7-12.

This main window is divided into the following sections:

- Section 1: there are five function buttons: configuration (chapter 7.3), search (chapter 7.4), alarm (chapter 7.5), about (chapter 7.6), log out (chapter 7.7).
- Section 2: there are channel number and three function buttons: start dialog, local play, and refresh.
- Section 3: there are PTZ (chapter 7.2.2), color (chapter 7.2.3) button and you can also select picture path and record path.
- Section 4: real-time monitor window. Please note current preview window is circled by a green rectangle zone.
- Section 5: Here you can view window switch button. You can also select video priority between fluency or real-time.
- ✧ System monitor window switch supports full screen/1-window/4-window/6-window/8-window/9-window/13-window/16-window/20-window/25-window/36-window. See Figure 7-11.



Figure 7-11

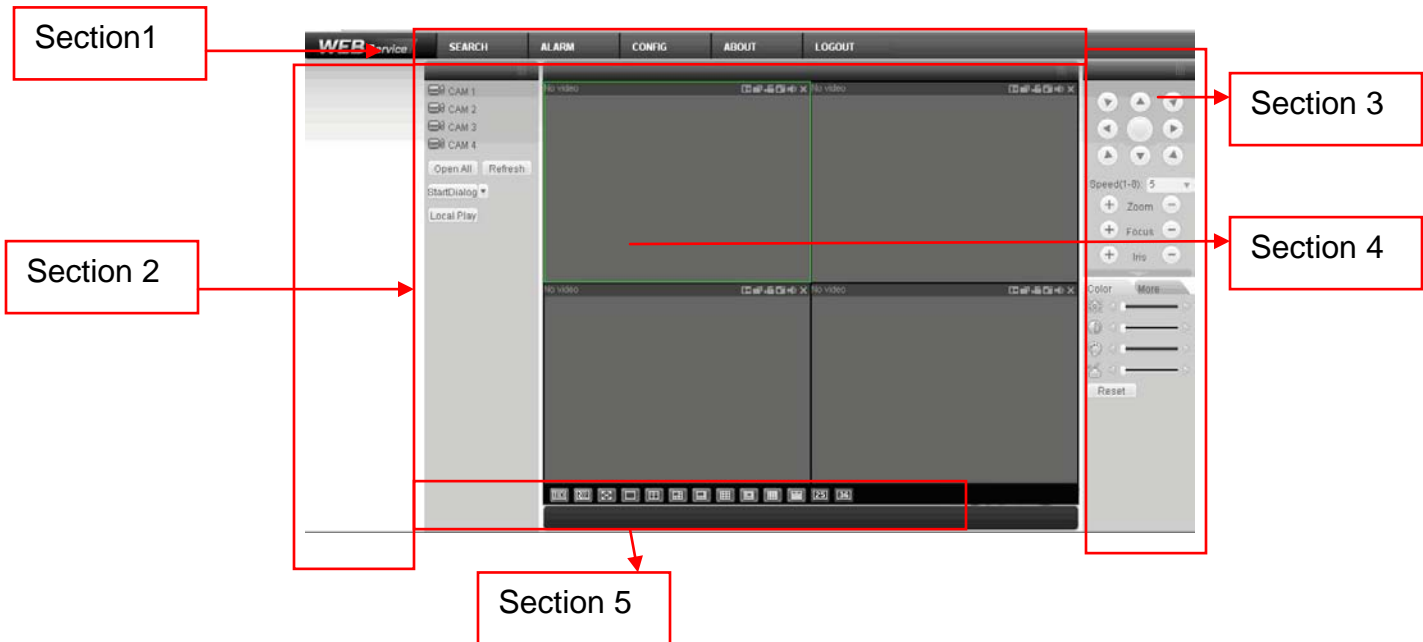

Figure 7-12

7.2.1 Real-time Monitoring

In section 2, left click the channel you want to view, you can see the corresponding video in current window. On the top left corner, you can view device IP, channel number, network monitor bit stream.

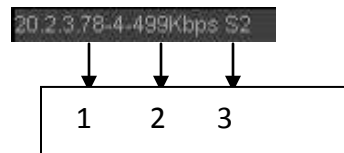

Figure 7-13

On the top right corner, there are six function buttons. See Figure 7-14.

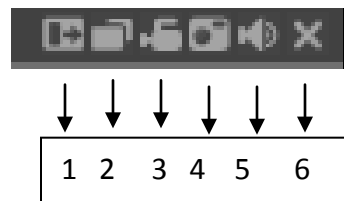

Figure 7-14

- 1: Digital zoom: Click this button and then left click and drag the mouse in the zone to zoom in. right clicking mouse restores original status.
- 2: Change show mode: resize or switch to full screen mode.
- 3: Local record. When you click local record button, the system begins recording and this button becomes highlighted. You can go to system folder RecordDownload to view the recorded file.
- 4: Capture picture. You can take snap shots of important video. All images are stored in system client folder \download\picture (default).
- 5: Audio: Turn audio on or off. (It has no relationship with system audio setup)
- 6: Close video.

Refer to Figure 7-15 for main stream and extra stream switch information.

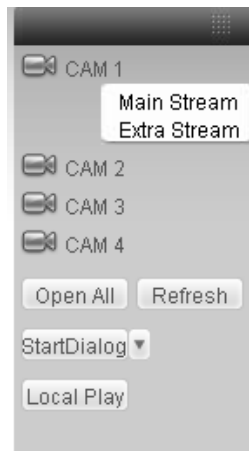

Figure 7-15

Open All

You can click it to open all channels.

Refresh

You can use button to refresh camera list.

Start Dialogue

You can click this button to enable audio talk. Click **▼** to select bidirectional talk mode. There are two options: DEFAULT/G711a.

Please note, the audio input port from the device to the client-end is using the first channel audio input port. During the bidirectional talk process, system will not encode the audio data from the 1-channel.

Local Play

The Web can playback the saved (Extension name is dav) files on the PC-end.

Click local play button, system displays the following interface for you to select local play file. See Figure 7-16.



Figure 7-16

7.2.2 PTZ

Before PTZ operation, please make sure you have properly set PTZ protocol. (Please refer to chapter 7.3.2 Setting-> Pan/Tilt/Zoom).

Click PTZ button, the interface is shown in Figure 7-17.

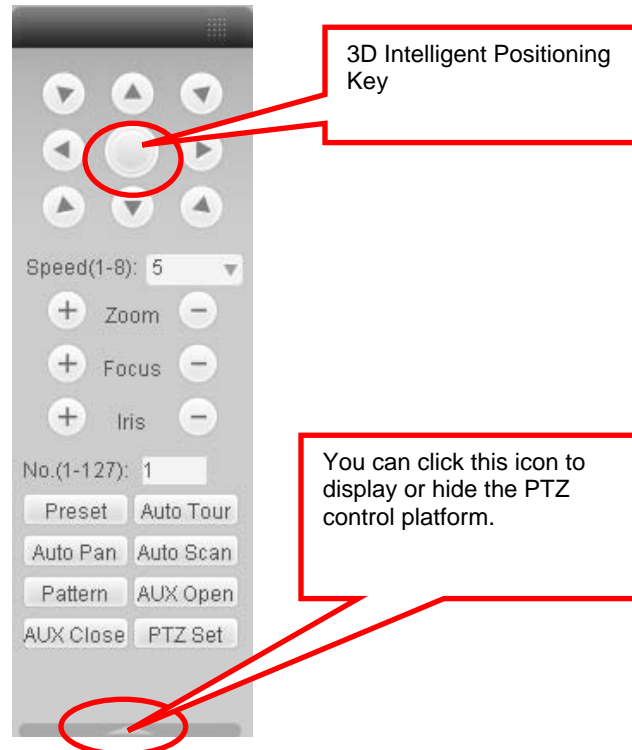

Figure 7-17

Direction key and 3D positioning key

In Figure 7-17, there are eight direction keys.

In the middle of the eight direction keys, there is a 3D intelligent positioning key.







Click 3D intelligent positioning key, system goes back to the single screen mode. Drag the mouse in the screen to adjust section size. It can access PTZ automatically.

Speed

System supports eight-level speed. You can select from the dropdown list. Speed 2 is faster than speed 1.

Zoom/Focus/Iris

Here is a chart for you reference.

Name	Function key	Function	Function key	Function
Zoom		Near		Far
Focus		Near		Far
Iris		close		Open

In Figure 7-17, click PTZ setup button you can see the following interface. See Figure 7-18.

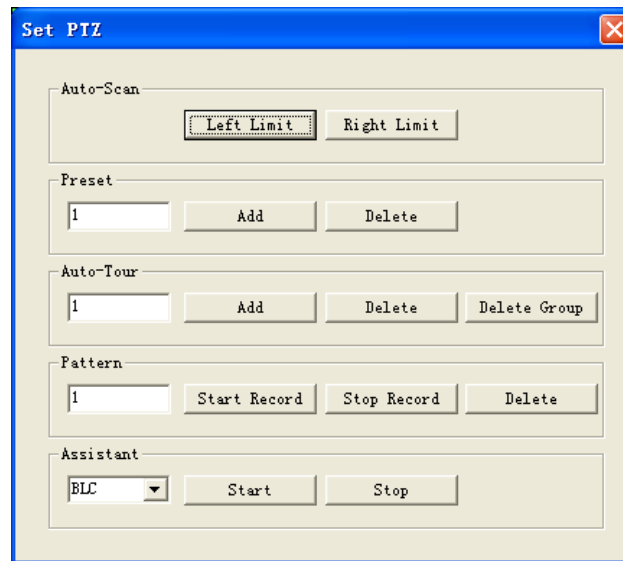

Figure 7-18

Auto Scan

In Figure 7-18, move the camera to your desired location and then click left limit button. Then move the camera again and then click right limit button to set a right limit.

Pattern

In Figure 7-18, you can input pattern value and then click start record button to begin PTZ movement. Go back to Figure 7-11 to implement camera operation. Then you can click stop record button. Now you have set one pattern.

Preset

In Figure 7-18, move the camera to your desired location and then input preset value. Click add button, you have set one preset.

Auto tour

In Figure 7-18, input auto tour value and preset value. Click add button, you have added one preset in the tour. Repeating the above procedures you can add more presets in one tour.

Assistant

You can select the assistant item from the dropdown list. See Figure 7-19.

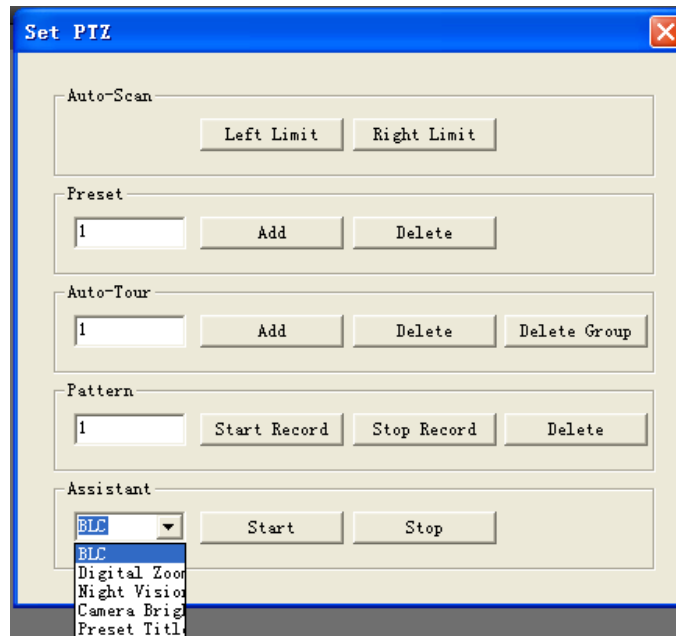

Figure 7-19

7.2.3 Color

Click color button in section 3, the interface is shown in Figure 7-20.

Here you can select one channel and then adjust its brightness, contrast, hue and saturation. (Current channel border becomes green).

Or you can click default button to use system default setup.

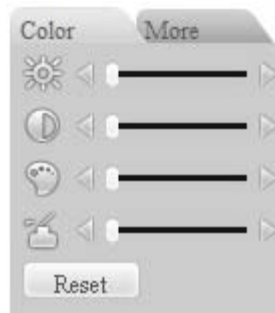

Figure 7-20

7.2.4 Picture Path and Record Path

Click more button in Figure 7-20, you will see the interface shown in Figure 7-21.

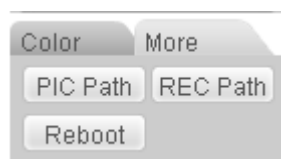

Figure 7-21

Click picture path button, you can will see the interface shown in Figure 7-22.
Please click choose button to modify path.

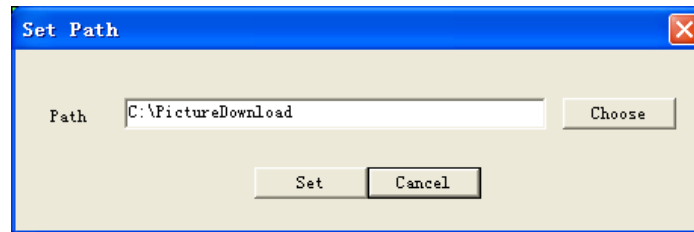

Figure 7-22

Click record path button, you will see athe interface shown in Figure 7-23.
Please click choose button to modify path.

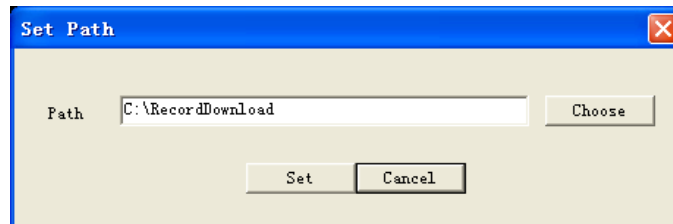

Figure 7-23

Click reboot button, system displays the following dialogue box. See Figure 7-24,
Please click OK to reboot.

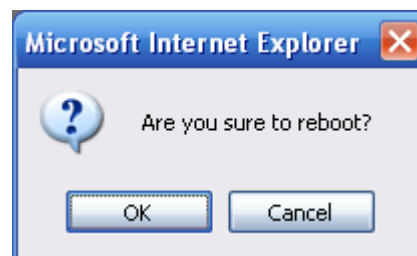

Figure 7-24

If there is a local user logged into the system menu, or the Web logged in user has no right to reboot the device, system pops up a dialogue box to alert you.

7.3 Configure

7.3.1 System Information Version Information

Here you can view device hardware feature and software version information. See Figure 7-25.

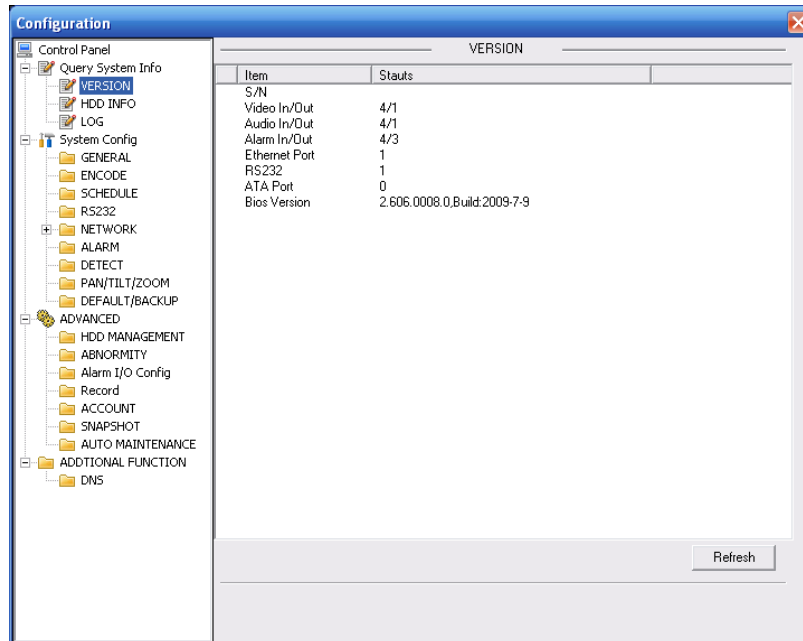

Figure 7-25

HDD information

Here you can view local storage status and network status including free capacity and total capacity. See Figure 7-26.

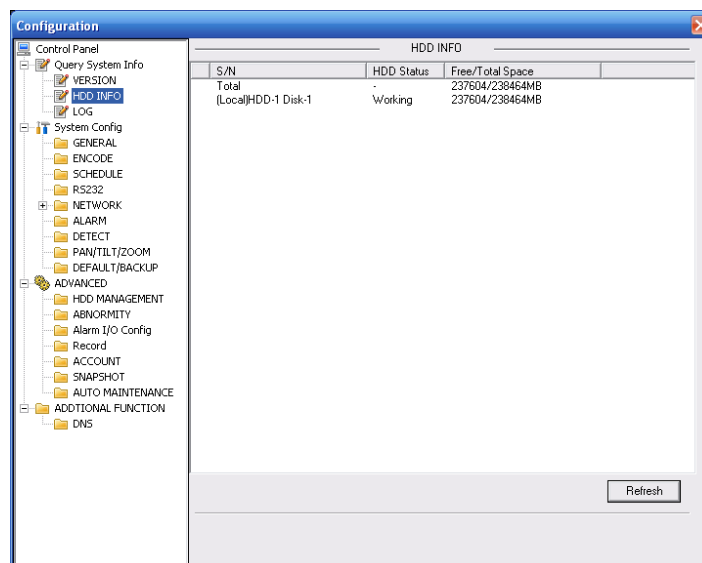

Figure 7-26

Log

Here you can view system log. See Figure 7-27.

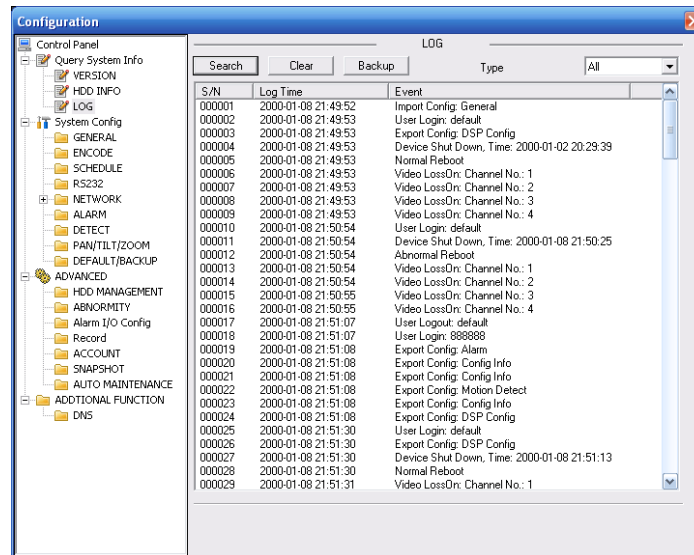

Figure 8-27

Click backup button, the interface is shown in Figure 7-28.

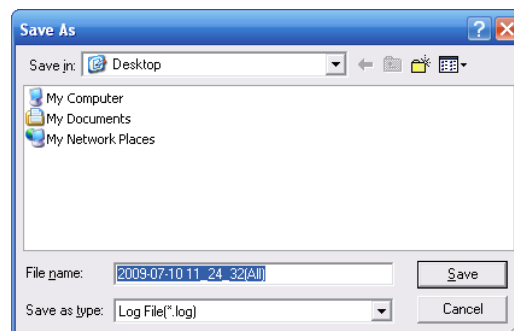

Figure 7-28

Please refer to the following chart for log parameter information.

Parameter	Function
Type	Log types include: system operation, configuration operation, data management, alarm event, record operation, user management, log clear and file operation.
Search	You can select log type from the drop down list and then click search button to view the list.
Clear	You can click this button to delete all displayed log files. Please note system does not support clear by type.
Backup	You can click this button to backup log files to current PC.

7.3.2 System Configuration

Please click save button to save your current setup.

General Setup

Here you can set system time, record length, video format etc. See Figure 7-29

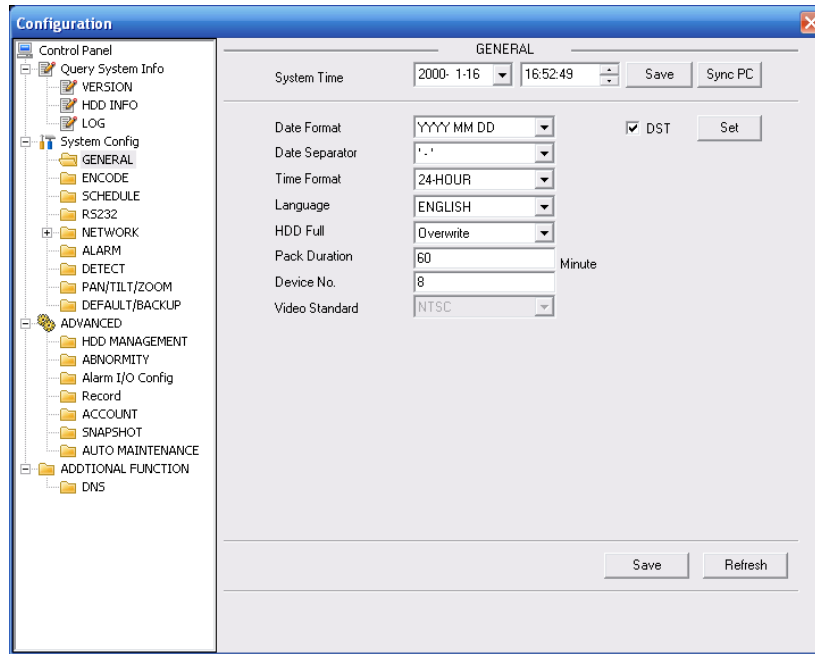

Figure 7-29

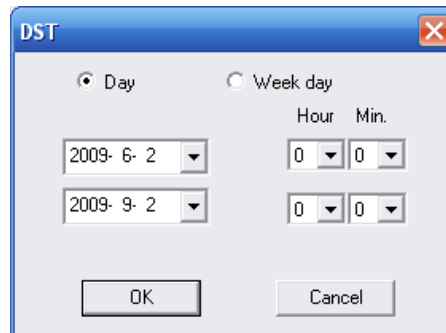

Figure 7-30

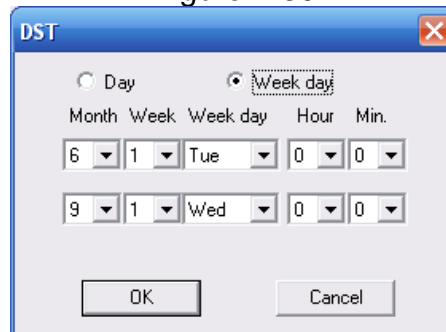

Figure 7-31

Please refer to the following chart for detailed information.

Parameter	Function
System Time	Here you can change system time. Please click Save button after your completed changing
Sync PC	You can click this button to save your PC current time as the system time
Data Format	Here you can select data format from the dropdown list.
Data Separator	Please select separator such as – or /.
Time Format	There are two options: 24-H and 12-H.
DST	Here you can set daylight saving time, begin time and end time. See Figure 7-24 and Figure 7-25.
Language	You can select the language from the dropdown list. Device needs to reboot to activate the change.
HDD Full	There are two options: stop recording or overwrite the previous files when HDD is full. When current working HDD is full, system stops recording. When current working HDD is full, system starts to overwrite the oldest files.
Pack Duration	Here you can select file size. The value ranges from 1 to 120. Default setup is 60 minutes.
Device No	When you are using one remote control to manage multiple devices, you can give serial numbers to the devices. Click the address button in the remote control and then input the corresponding number to control the combo DVR.
Video Standard	There are two options: PAL/NTSC. Please note, for the Web user, this information is for reference only. You can not change.

Encode

Encode interface is shown in Figure 7-32.

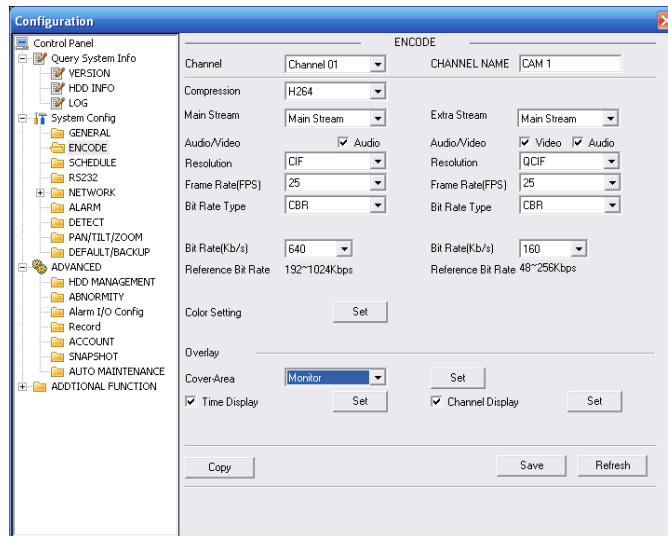

Figure 7-32

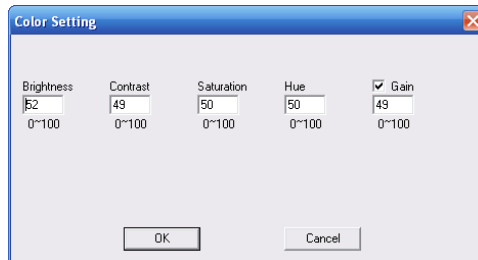

Figure 7-33

Please refer to the following chart for detailed information.

Parameter	Function
Channel	Here you can select a monitor channel.
Channel Name	Displays current channel name. You can modify it.
Compression	H.264
Main Stream	Includes main stream, motion stream and alarm stream. You can select different encode frame rates for different recorded events. For example, you can use high frame rate to record important events, record scheduled events in lower frame rate and it allows you to set different frame rates for motion detection record and alarm record.
Extra Stream	Select extra stream if you enabled the extension stream to monitor.

Parameter	Function
Audio/Video	<p>For the main stream, recorded file only contains video by default. You need to put a checkmark here to enable audio function.</p> <p>For extra stream, you need to put a checkmark to select the video first and then select the audio if necessary.</p>
Resolution	<p>Main stream resolution supports D1/CIF/QCIF.</p> <p>Extra stream of channel 1 to channel 8 supports QCIF only.</p>
Frame Rate	<p>PAL : 1 ~25f/s ; NTSC : 1 ~30f/s</p> <p>For the 8-ch series combo DVR, you can refer to the following information:</p> <p>If the 1-channel resolution is D1 and the frame rate is more than 6f/s, then the other seven channels (the second channel to the eighth channel) resolution shall be CIF or QCIF.</p> <p>If the 1-channel resolution is D1 and the frame rate is or less than 6f/s, then the rest seven channels (the second channel to the eighth channel) resolution shall be D1/CIF/QCIF. Right now in D1 resolution the maximum frame rate is 6f/s for all channels.</p>
Bit Rate Type	<p>There are two options: VBR and CBR.</p> <p>Please note, you can set video quality in VBR mode only.</p>
Quality	<p>The value ranges from 1 to 6. The level 6 is the best video quality.</p>
Bit Rate	<ul style="list-style-type: none"> • In CBR, the bit rate here is the max value. In dynamic video, system needs to low frame rate or video quality to guarantee the value. • The value is null in VBR mode. • Please refer to recommend bit rate for the detailed information.
Recommended Bit	<p>Recommended bit rate value according to the resolution and frame rate you have set.</p>
Color Setting	<p>Here you can set video brightness, contrast, hue, saturation and gain.</p> <p>The value ranges from 0 to 100. Default value is 50. See Figure 7-27.</p>
Cover area (privacy mask)	<ul style="list-style-type: none"> • Here you can privacy mask the specified video on the monitor. • One channel supports up to 4 privacy mask zones. • The privacy mask includes two options: Never/monitor. Never: It means do not enable privacy mask function. Monitor: the privacy mask zone can not be viewed in monitor mode.
Time Title	<ul style="list-style-type: none"> • You can enable this function so that system overlays time information in the video window. • OSD transparent value ranges from 0 to 255. 0 means completely transparent. • You can use the mouse to drag the time tile position.

Parameter	Function
Channel Title	<ul style="list-style-type: none"> You can enable this function so that system overlays channel information in video window. OSD transparent value ranges from 0 to 255. 0 means completely transparent. You can use the mouse to drag the channel tile position.
Copy	This is a shortcut menu button. You can copy current channel setup to one or more channels. The interface is shown in Figure 7-28.
Save	You can click save button after you complete setup for one channel, or you can complete the whole setup and then click save button.
Refresh	Click this button to get device's latest configuration information.

Click copy interface, the interface is shown in Figure 7-34.

If you have completed the setup for channel 1, you can click 3 to copy current setup to channel 3. Or you can click 2, 3, and 4 to copy current setup to channel 2, channel 3 and channel 4.

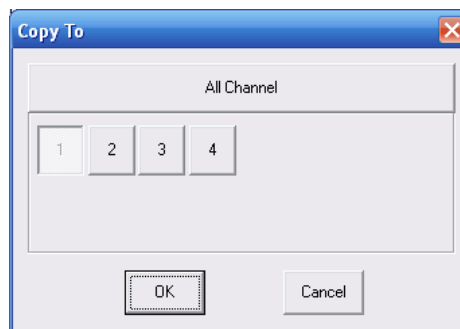

Figure 7-34

Schedule

Here you can set different periods for various days. There is a maximum of six periods in one day. See Figure 7-35

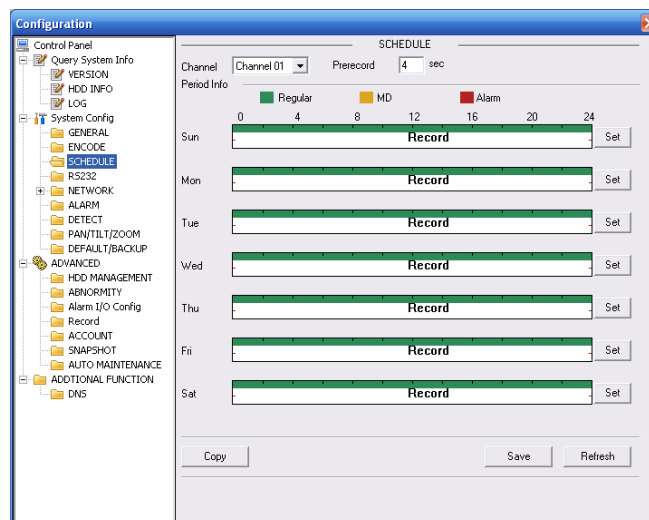

Figure 7-35

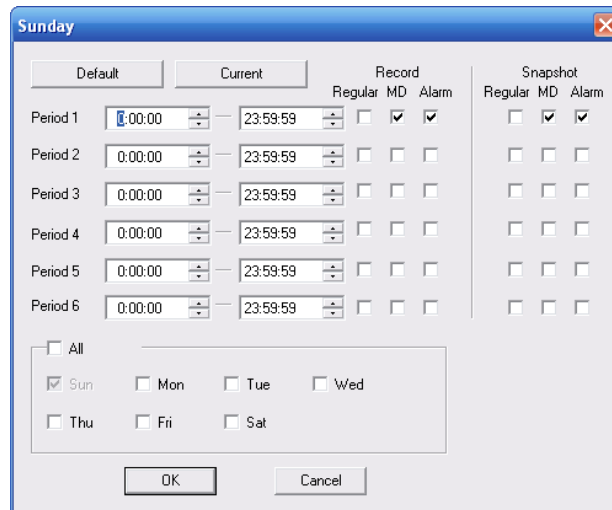

Figure 7-36

Please refer to the following chart for detailed information.

Parameter	Function
Channel	Select a channel first.
Pre-record	Input pre-record value here. System can record three to five seconds of video before activating the record operation into the file. (Depends on data size).
Setup	<ul style="list-style-type: none"> • In Figure 7-29, click set button, you can go to the corresponding setup interface. • Please set schedule period and then select corresponding record or snapshot type: schedule/snapshot, motion detection/snapshot, and alarm/snapshot. • Please select date (Current setup applies to current day by default. You can put a checkmark before the week to apply the setup to the whole week.) • After complete setup, please go back to Figure 7-29 and then click save to save current time period setup.
Copy	This is a shortcut menu button. You can copy current channel setup to one or more (all) channels. The interface is shown in Figure 7-28.
Save	You can click save button after you complete setup for one channel, or you can complete the whole setup and then click save button.
Refresh	Click this button to get device's latest configuration information.

RS232

The RS232 interface is shown in Figure 7-37

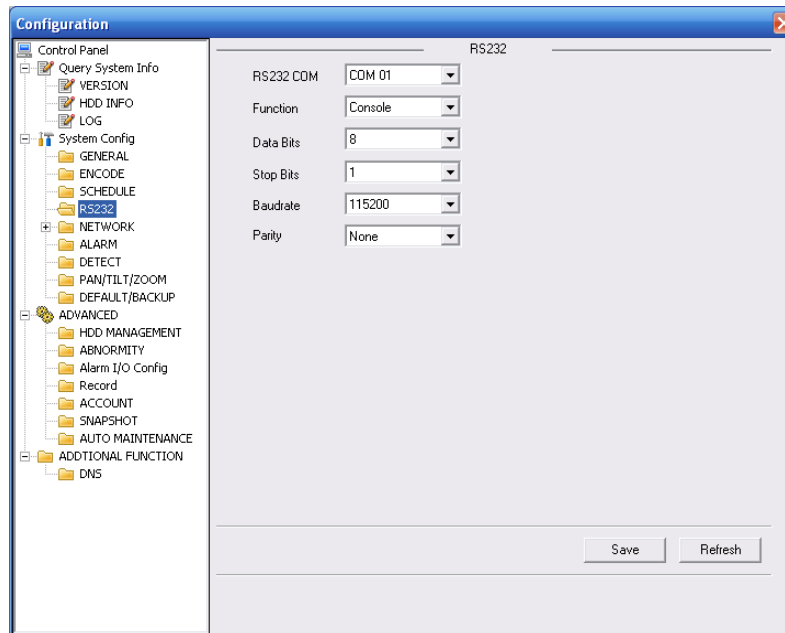

Figure 7-37

Please refer to the following chart for detailed information.

Parameter	Function
RS232	There are two options: COM 01 and keyboard.
Function	Console is to upgrade the program or debug via COM or mini terminal software. Keyboard: COM control protocol. You can use keyboard to control combo DVR via COM.
Data Bit	The value ranges from 5 to 8.
Stop Bit	There are two options: 1/2.
Baud Bit	You can select corresponding baud bit here.
Parity	There are three options: none/odd/even.

System default setup is:

- Function: Console.
- Data bit: 8
- Stop bit: 1
- Baud bit: 115200
- Parity: None.

Network

Network interface is shown in Figure 7-38.

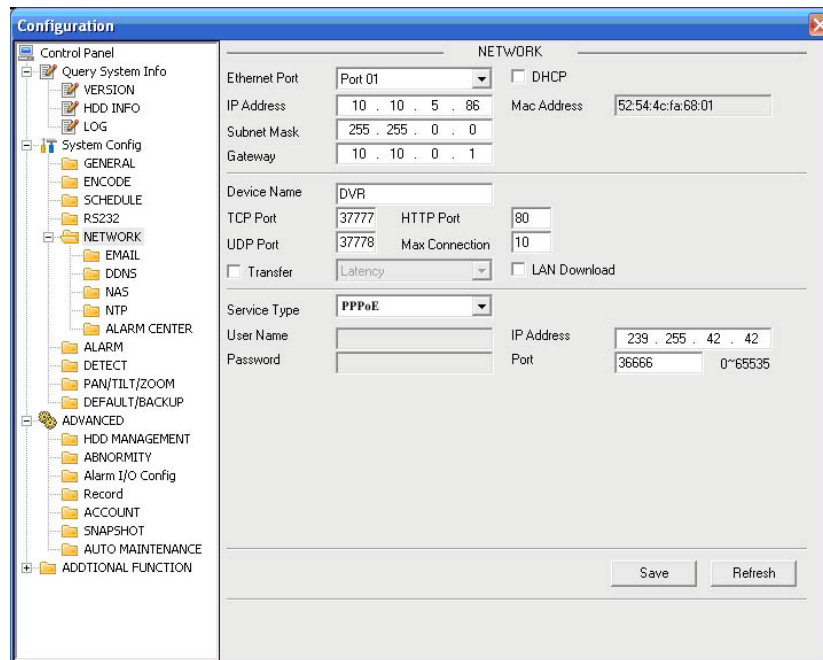

Figure 7-38

Please refer to the following chart for detailed information.

Function
Select the network card first.
Dynamically get IP address. You can get the device IP from the router if you enable this function.
Default value is 37777.
Default value is 80.
Default value is 37778.
Maximum Network users. The value ranges from 0 to 10. 0 means no users can access current device.

Function	
PPPOE	<ul style="list-style-type: none"> • Input the PPPoE user name and password you get from the IPS (internet service provider) and enable PPPoE function. Please save current setup and then reboot the device to get the setup activated. • Device connects to the internet via PPPoE after reboot. You can get the IP address in the WAN from the IP address column. • Please note if you want to reboot the device please make sure you have proper reboot right and there is no user logged in.

Email

The email interface is shown in Figure 7-39.

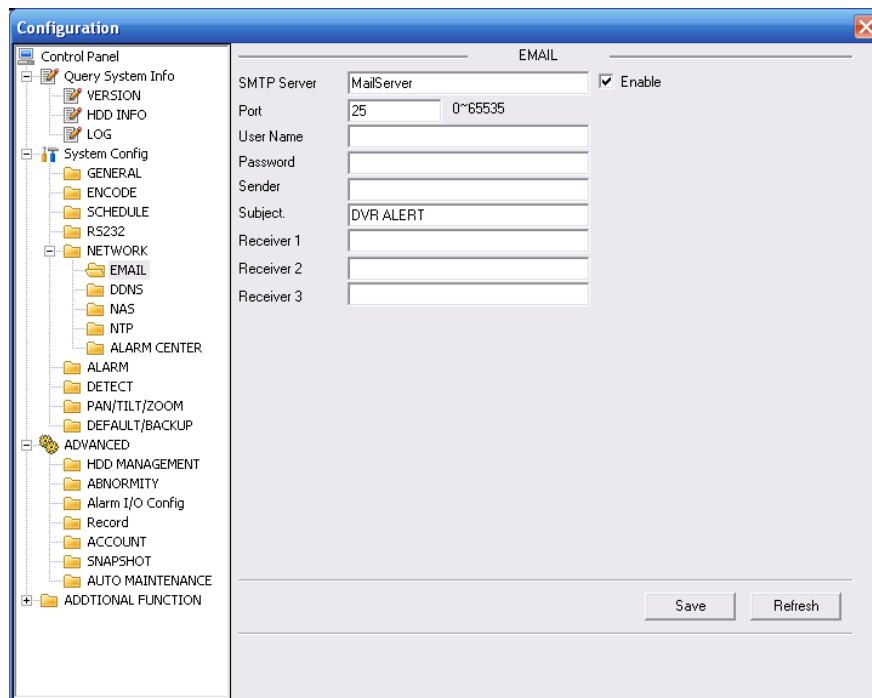

Figure 7-39

Please refer to the following chart for detailed information.

Parameter	Function
SMTP Server	Input server address and then enable this function.
Port	Please input port value here.
User Name	The sender email account user name.
Password	The sender email account password.

Parameter	Function
Sender	Sender email address.
Subject	Input email subject here. Maximum 32-digits.
Address	Input receiver email address here. Max input three addresses.

DDNS

The DDNS interface is shown in Figure 7-40.

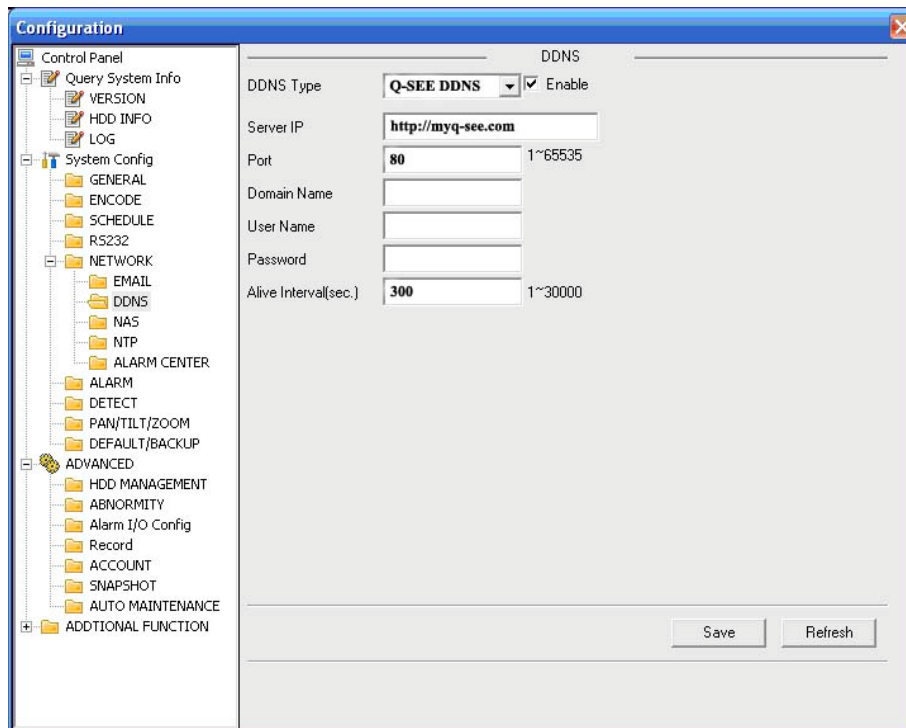

Figure 7-40

Please refer to the following chart for detailed information.

Parameter	Function
Server Type	You can select DDNS protocol from the dropdown list and then enable DDNS function. The private DDNS protocol means you use your self-defined private protocol to activate DDNS function.
Server IP	DDNS server IP address
Server Port	DDNS server port.
Domain Name	Your self-defined domain name.
User	The user name you input to log in the DDNS server.
Password	The password you input to log in the DDNS server.
Interval	<ul style="list-style-type: none"> • Device sends out a live signal to the server regularly. • You can set interval value between the device and DDNS server here.

NAS

NAS interface is shown in Figure 7-41.

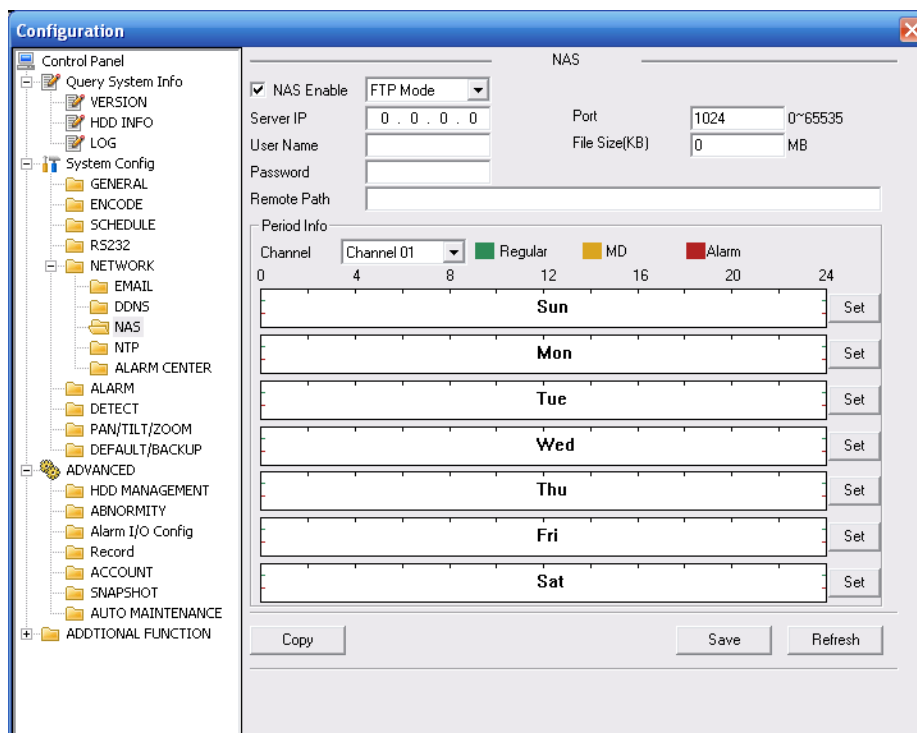

Figure 7-41

Please refer to the following chart for detailed information.

Parameter	Function
NAS enable	Select network storage protocol and then enable NAS function.
Server IP	Input remote storage server IP address.
Port	Input remote storage server port number.
User Name	Log in user account.
File length	The file length you upload to the FTP. When setup is larger than the actual file length, system will upload the whole file. When setup here is smaller than the actual file length, system only uploads the set length and auto ignore the left section. When interval value is 0, system uploads all corresponding files.
Password	The password you need to log in the server.
Remote Path	Remote storage file path.
Save	You can click save button after you complete setup for one channel, or you can complete the whole setups and then click save button.
Refresh	Click this button to get device's latest configuration information.

NTP

The NTP interface is shown in Figure 7-42.

Here you can activate network time synchronization. Please enable current function and then input server IP, port number, time zone and update interval. Please note the SNTP supports TCP transmission only and its port shall be 123. The update interval ranges from 1 to 65535. Default value is 10 minutes.

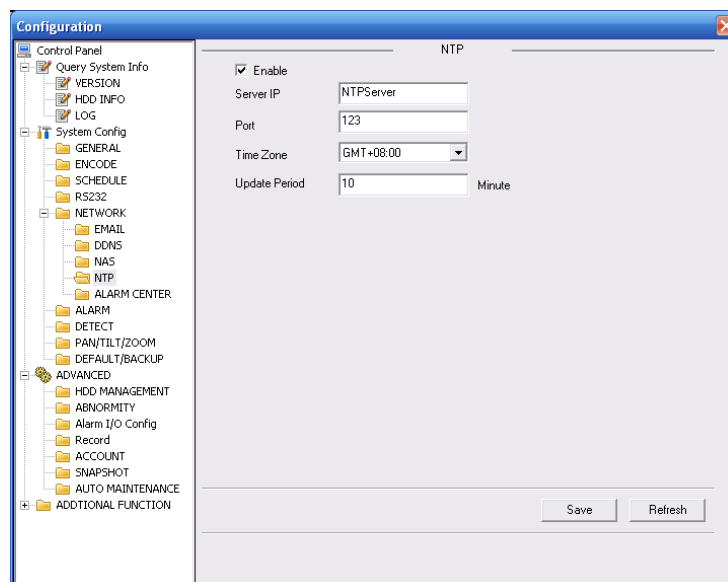

Figure 7-42

You can refer to the following chart for time zone information.

City /Region Name	Time Zone
London	GMT+0
Berlin	GMT+1
Cairo	GMT+2
Moscow	GMT+3
New Deli	GMT+5
Bangkok	GMT+7
Beijing (Hong Kong)	GMT+8
Tokyo	GMT+9
Sydney	GMT+10
Hawaii	GMT-10
Alaska	GMT-9
Pacific Time(P.T)	GMT-8
American Mountain Time(M.T)	GMT-7
American Central Time(C.T)	GMT-6
American Eastern Time(E.T)	GMT-5
Atlantic Time	GMT-4
Brazil	GMT-3
Middle Atlantic Time	GMT-2

Alarm

Alarm setup interface is shown in Figure 7-44.

Make sure you have connected the corresponding alarm output device such as the light, buzzer etc.

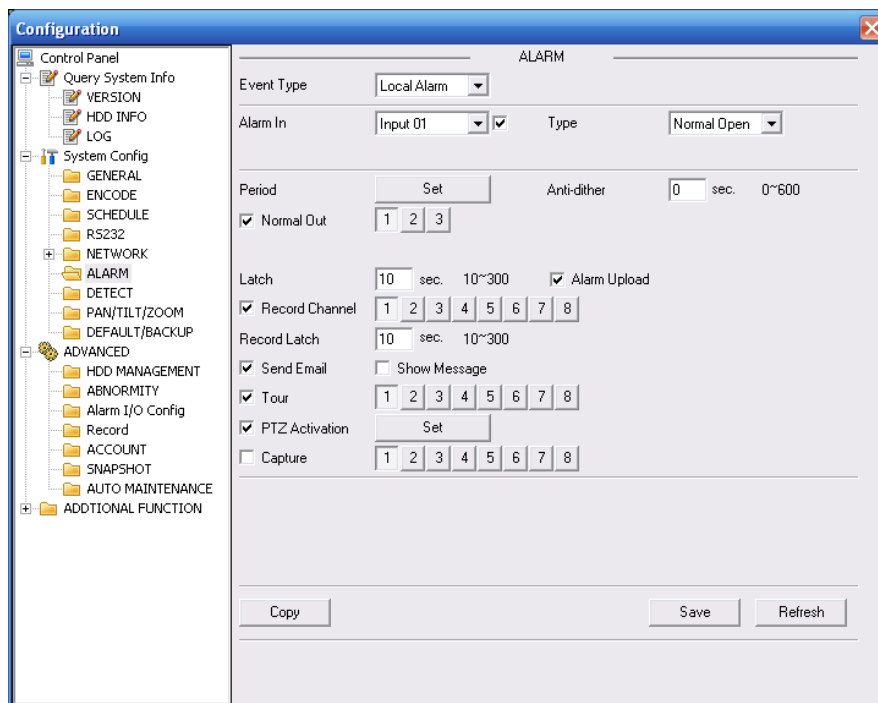

Figure 7-44

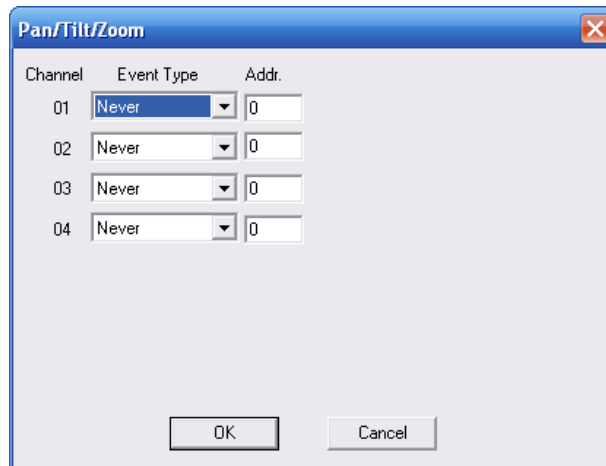

Figure 7-45

Please refer to the following chart for detailed information.

Parameter	Function
Event Type	Includes local alarm/network alarm. Local alarm: Device detects alarm from input port. Network: Device detects alarm from network.
Alarm in	Select corresponding alarm channel.
Enable	You need to put a checkmark here so that system can detect the alarm signal.
Type	There are two options: normal open and normal close. NO becomes activated in low voltage, NC becomes activated in high voltage.
Period	Alarm record function becomes activated in the specified periods. There are six periods in one day. Put a checkmark to enable corresponding period. Select date. If you do not select, current setup applies to today only. You can select all week column to apply to the whole week. Click OK button, system goes back to alarm setup interface, please click save button to exit.
Anti-dither	System only memorizes one event during the anti-dither period. The value ranges from 0 to 15s.
Normal Out	Enable alarm activation function. You need to select alarm output port so that system can activate corresponding alarm device when alarm occurs.
Alarm Latch	System can delay the alarm output for specified time after alarm ends. The value ranges from 10 seconds to 300 seconds.
Alarm upload	System can upload the alarm signal to the centre (Including alarm centre).
Record Channel	System auto activates current channel to record once alarm occurs (working with alarm activation function). Please note current device shall be in alarm record period (Chapter 7.3.2.3 Schedule) and you have enabled the schedule record function in chapter 7.3.3.3 Record.
Record Latch	System can delay the record for specified time after alarm ends. The value ranges from 10s to 300s.

Parameter	Function
Email	Put a checkmark to enable email function. System can send out email to alert you when alarm occurs and ends.
Tour	Display the selected video in local monitor window. Tour interval and tour mode are set in combo DVR local menu (chapter 5.3.9 Display)
PTZ activation	Here you can set PTZ movement when alarm occurs. Such as go to preset x when there is an alarm. The PTZ configuration events include preset, tour, and pattern.
Capture	You need to input capture channel number so that system can backup snapshot file when alarm occurs.
Copy	This is a shortcut menu button. You can copy current channel setup to one or more (all) channels.
Save	You can click save button after you complete setup for one channel, or you can complete the whole setup and then click save button.
Refresh	Click this button to get device's latest configuration information.

Motion Detection

The detection interface is shown in Figure 7-46.

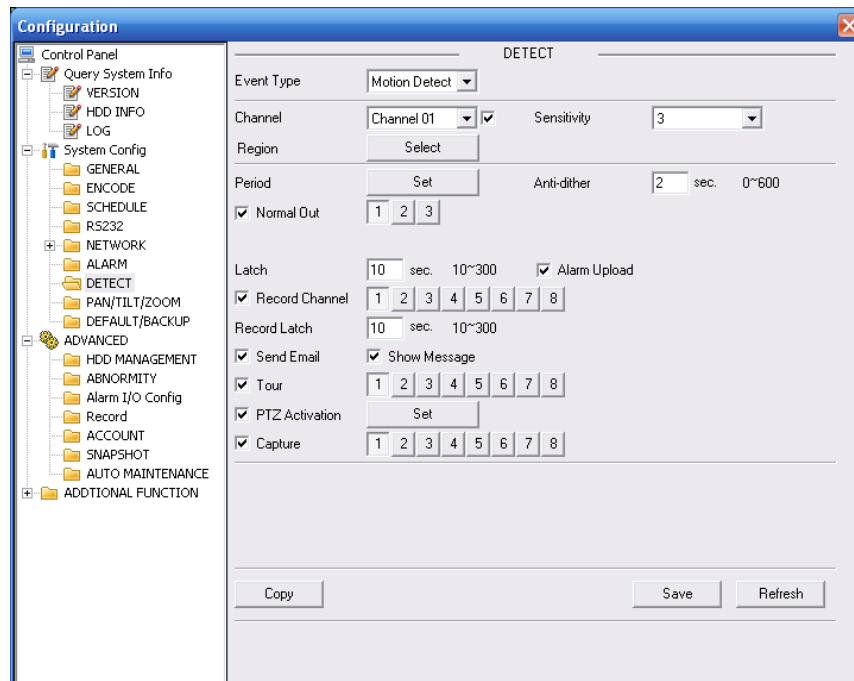

Figure 7-46

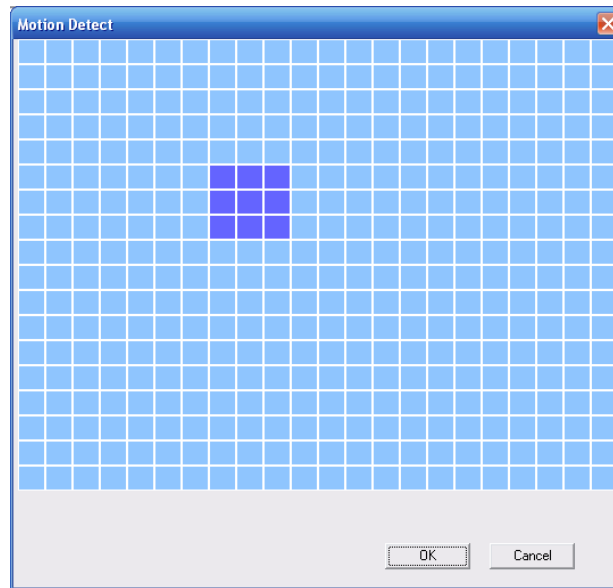

Figure 7-47

Please refer to the following chart for detailed information:

Parameter	Function
Event Type	There are three types: Motion detection/video loss/Camera Masking.
Channel	Select channel name from the dropdown list.
Enable	You need to put a checkmark to enable motion detection function.
Sensitivity	There are six levels. The sixth level has the highest sensitivity.
Region	<ul style="list-style-type: none"> Region: If you select motion detection type, you can click this button to set motion detection zone. The interface is shown in Figure 7-41. There are PAL 22X18/NTSC 22X15 zones. Right click mouse you can go to full-screen display mode. Click OK button to save your motion detection zone setup.
Period	<ul style="list-style-type: none"> Motion detection function becomes activated in the specified periods. There are six periods in one day. Put a checkmark to enable corresponding period. Select date. If you do not select, current setup applies to today only. You can select all week column to apply to the whole week. Click OK button, system goes back to motion detection interface; please click save button to exit.
Anti-dither	System only memorizes one event during the anti-dither period. The value ranges from 0s to 15s.

Parameter	Function
Normal out	<ul style="list-style-type: none"> • There is 2-channel alarm output. • Corresponding to motion detection alarm output port (multiple choices) • Enable alarm activation function. You need to select alarm output port so that system can activate corresponding alarm device when alarm occurs.
Alarm latch	System can delay the alarm output for specified time after alarm ends. The value ranges from 10s to 300s.
Alarm upload	System can upload the alarm signal to the centre (Including alarm centre).
Record channel	System auto activates motion detection channel (multiple choices) to record once alarm occurs (working with motion detection function). Please note current device shall be in alarm record period (Chapter 7.3.2.3 Schedule) and you have enabled the schedule record function in chapter 7.3.3.3 Record.
Record latch	System can delay the record for specified time after alarm ends. The value ranges from 10s to 300s.
Email	If you enabled this function, System can send out an email to alert you when alarm occurs and ends.
Tour	<ul style="list-style-type: none"> • Display the selected video in local monitor window. • Tour interval and tour mode are set in combo DVR local menu (chapter 5.3.9 Display)
PTZ Activation	<ul style="list-style-type: none"> • Here you can set PTZ movement when alarm occurs. Such as go to preset x when there is an alarm.
Capture	You need to input capture channel number so that system can backup motion detection snapshot file.
Copy	This is a shortcut menu button. You can copy current channel setup to one or more (all) channels.
Save	You can click save button after you complete setup for one channel, or you can complete the whole setup and then click save button.
Refresh	Click this button to get device's latest configuration information.

PTZ

PTZ interface is shown in Figure 7-48

Please note, before operation make sure you have set speed dome address, and combo DVR and speed dome connections are OK.

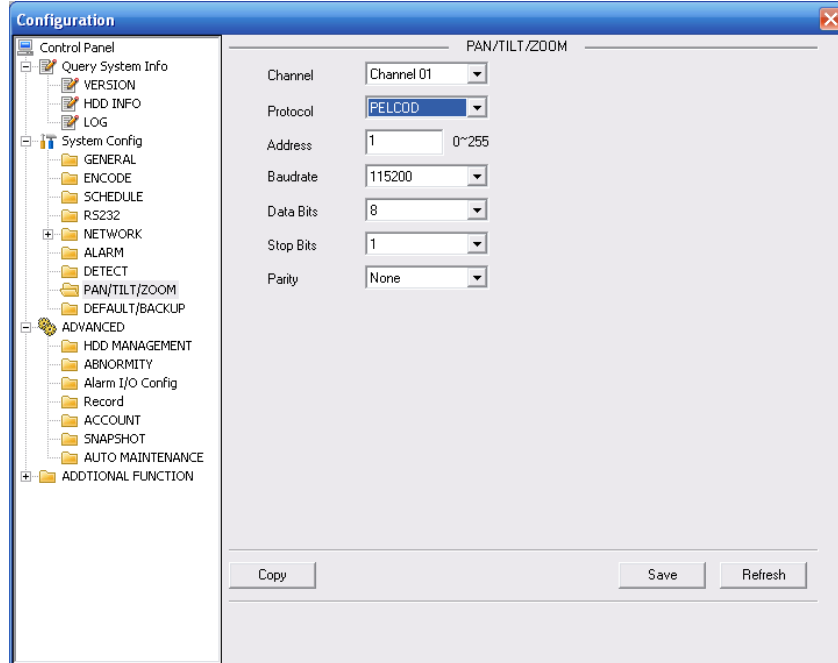

Figure 7-48

Please refer to the following chart for detailed information.

Parameter	Function
Channel	You can select monitor channel from the dropdown list. .
Protocol	Select the corresponding dome protocol.(such as PELCOD)
Address	Set corresponding dome address. Default value is 1. Your setup here must comply with your dome address; otherwise you can not control the speed dome.
Baud Rate	Select the dome baud rate. Default setup is 9600.
Data Bit	Default setup is 8. Set according to the speed dome dial switch setup.
Stop bit	Default setup is 1. Set according to the speed dome dial switch setup.
Parity	Default setup is none. Set according to the speed dome dial switch setup.
Save	You can click save button after you complete setup for one channel, or you can complete the whole setup and then click save button.
Refresh	Click this button to get device's latest configuration information.

Default & Backup

Default: Restore factory default setup. You can select corresponding items.

Backup: Export current configuration to local PC or import configuration from current PC.

Please refer to Figure 7-49.

Please note system can not restore some information such as network IP address.

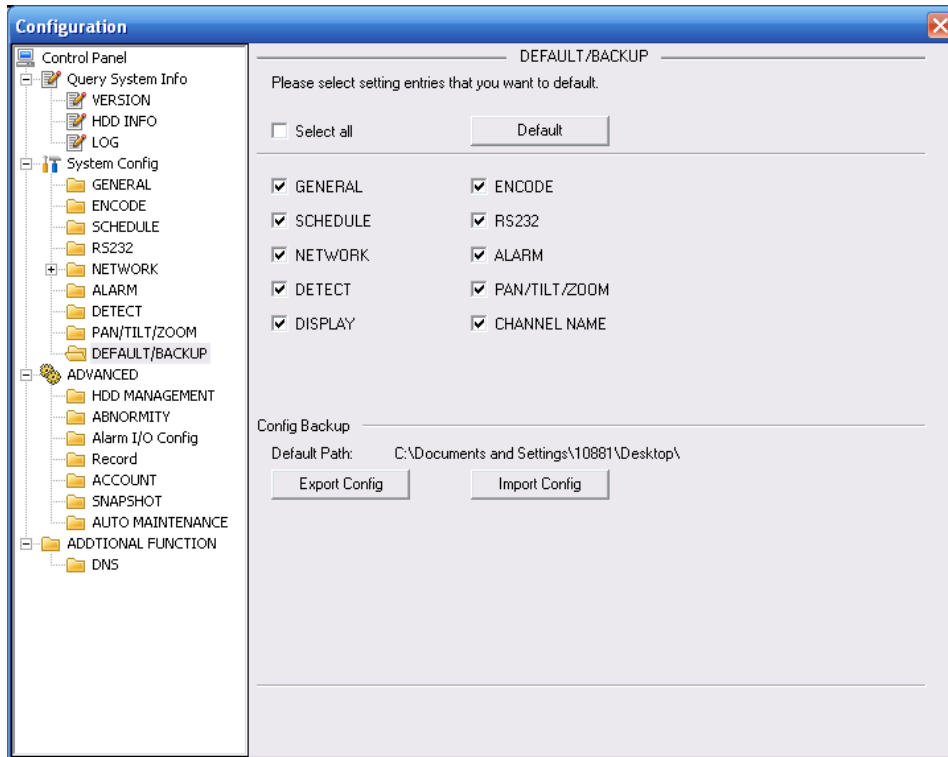

Figure 7-49

Please refer to the following chart for detailed information.

Parameter	Function
Select All	Restore factory default setup.
Export Configuration	Export system configuration to local PC.
Import Configuration	Import configuration from PC to the system.

7.3.3 Advanced HDD Management

HDD management includes net storage management and local storage management.

Please select the storage device first and then you can see the items on your right become valid. You can check the corresponding item here. See Figure 7-50.

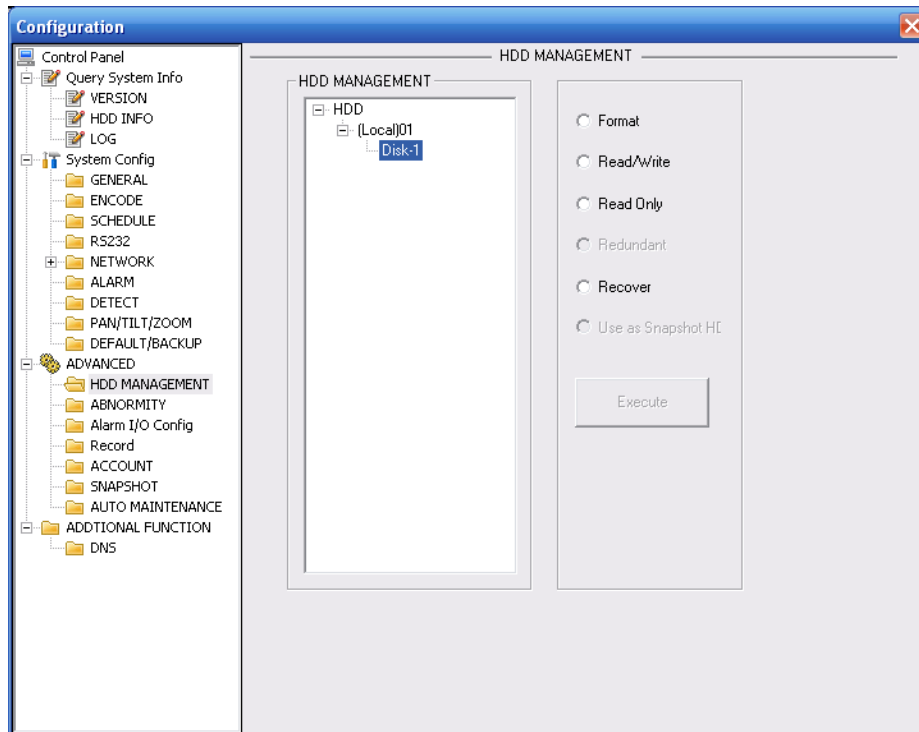

Figure 7-50

Please refer to the following chart for detailed information.

Parameter	Function
Format	Clear data on the drive.
Read/write	Set current SD card as read/write
Read only	Set current card as read only.
Recover	Recover data after error occurs.

Please note system needs to reboot to activate current setup.

Alarm I/O

Here you can search alarm output status. See Figure 7-51.

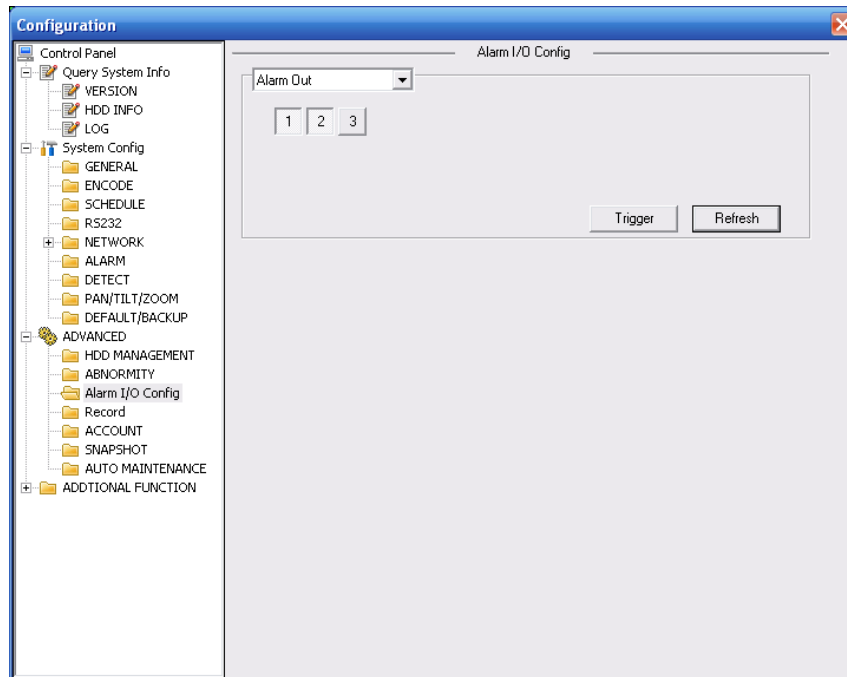

Figure 7-51

Important

The alarm output port should not be connected to high power load directly (It should be less than 1 Amp) to avoid high current which may result in relay damage. Please use the co-contactor to establish the connection between the alarm output port and the load.

Please refer to the following chart for detailed information.

Parameter	Function
Alarm output	There are three output channels (Multiple choices).
Activate	Enable/disable alarm output device. After the Web activated the alarm, you need to cancel the channel and then click the trigger button to cancel the alarm, or you need to cancel the alarm in the pop-up dialogue box in local-end.
Refresh	Search alarm output status.

Record

Record control interface is shown in Figure 7-52.

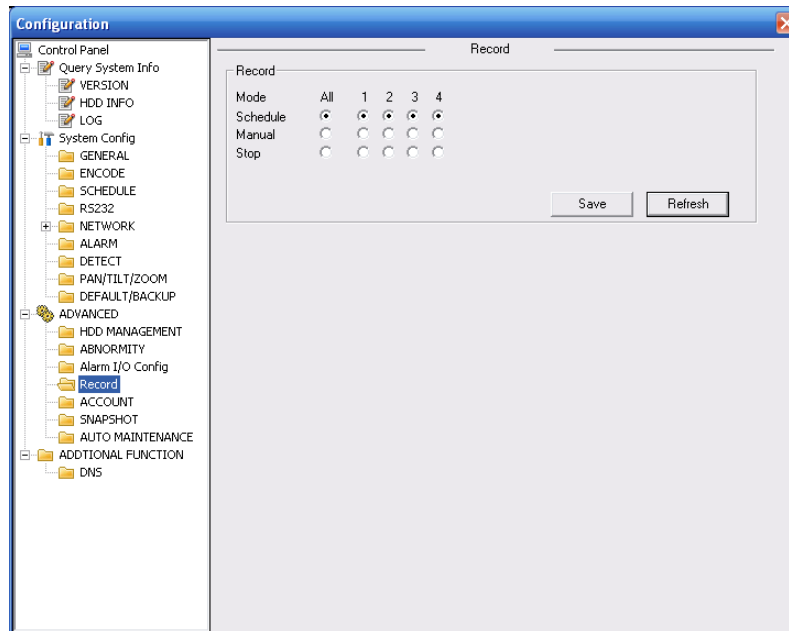

Figure 7-52

Please refer to the following chart for detailed information.

Parameter	Function
Schedule	System enables auto record function you setup in record schedule.
Manual	Enable corresponding channel to record no matter what period applied in the record setup.
Stop	Stop current channel record no matter what period applied in the record setup.

Operation here is the same to chapter 4.2 Manual Record. Please refer to chapter 4.2 for detailed information

Account

Here you can add, remove user or modify password. See Figure 7-53.

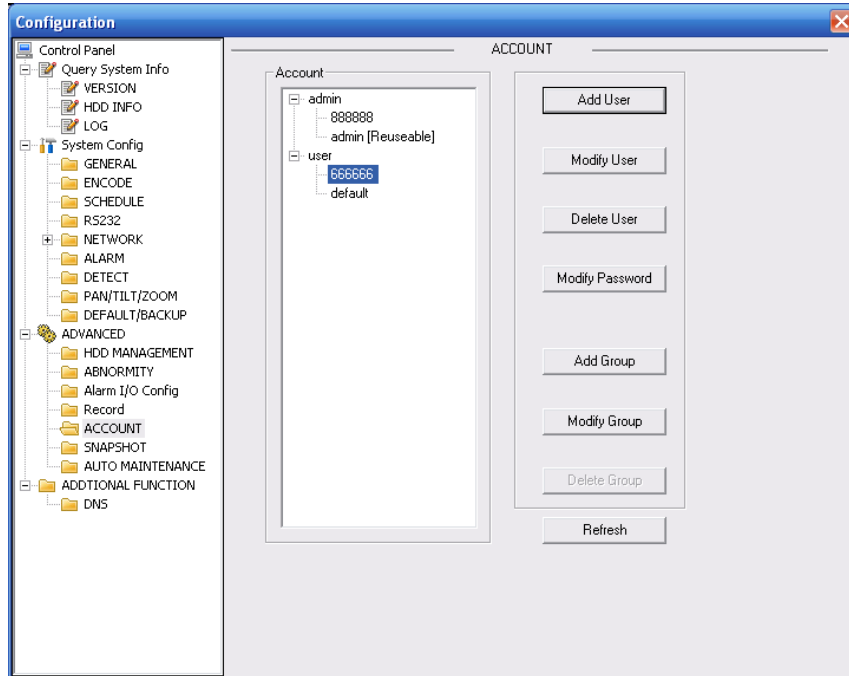

Figure 7-53

Auto Maintenance

Here you can select auto reboot and auto delete old files from the dropdown list. See Figure 7-54.

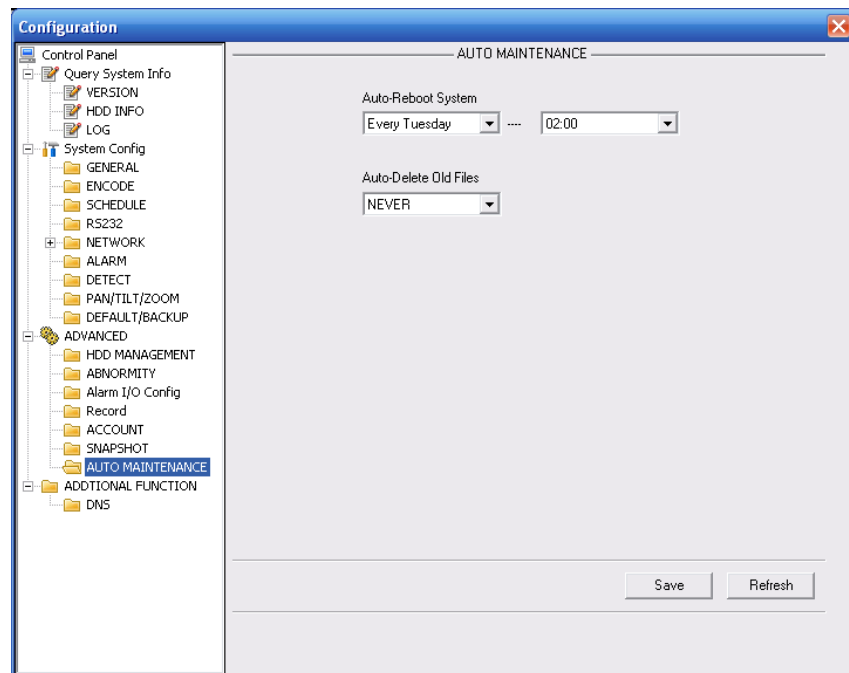

Figure 7-54

Snapshot

Snapshot interface is shown in Figure 7-55.

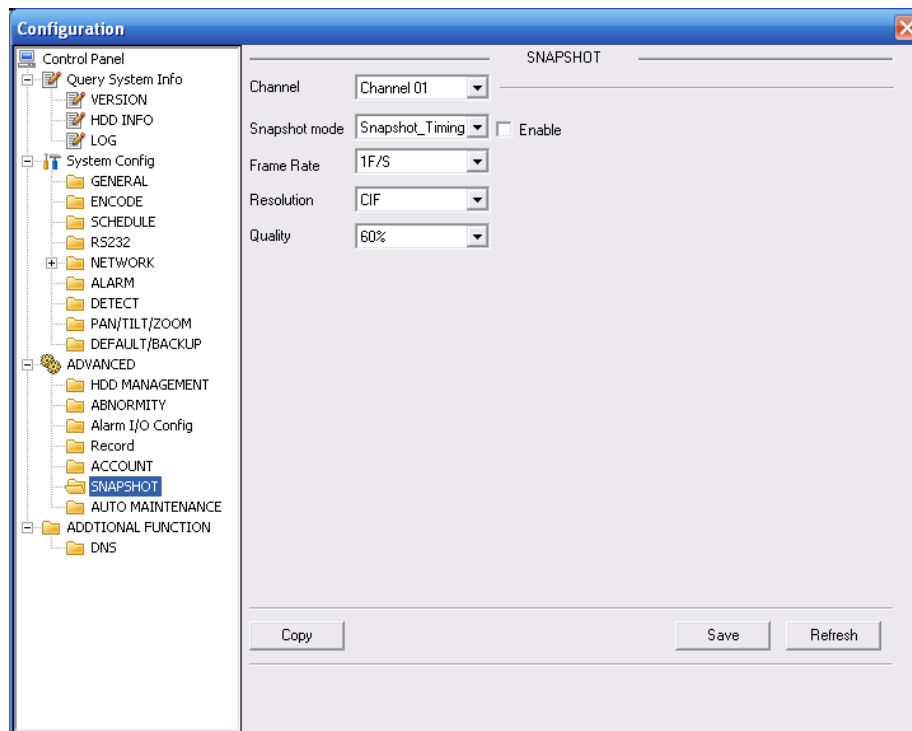

Figure 7-55

Please refer to the following chart for detailed information.

Parameter	Function
Channel	It is the monitor channel.
Snapshot mode	There are two modes: Timing and activation.
Frame rate	You can select from the dropdown list. The value ranges from 1f/s to 7f/s.
Resolution	Supports D1 resolution.
Quality	You can select from the dropdown list. Here you set video quality. There are six options: 10%, 30%, 50%, 60%, 80%, 100%. 100% is the best quality.

Abnormity

The abnormity interface is shown below. See Figure 7-56.

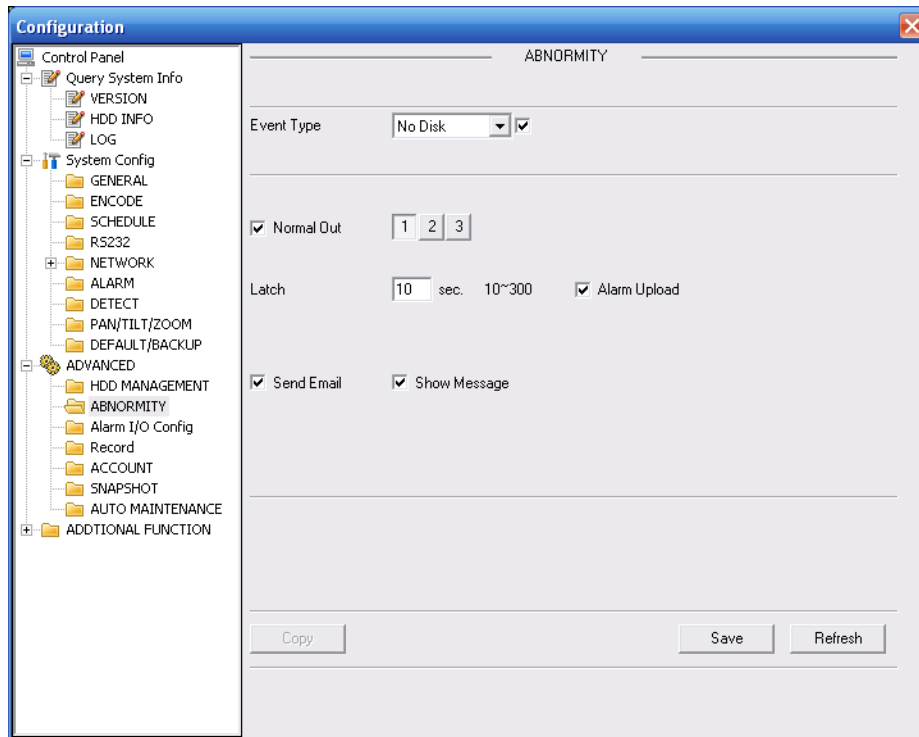

Figure 7-56

Please refer to the following chart for detailed information.

Parameter	Function
Event Type	<ul style="list-style-type: none"> The abnormal events include: no disk, no space, disk error, net error. You need to put a checkmark to enable this function.(Multiple choices)
Normal Out	The corresponding alarm activates output channel when alarm occurs, There are three channels.
Latch	The alarm output can delay for the specified time after alarm stops. Then system disables alarm and corresponding activation output. The value ranges from 10s to 300s.
Send email	If you enable this function, system can send out email to alert the specified user.
Alarm upload	System can upload the alarm signal to the network (including the alarm centre.)
Show message	System can display alarm information in local combo DVR screen.

7.3.4 Additional Function DNS

Here you can set server or local operator DNS address. See Figure 7-57.

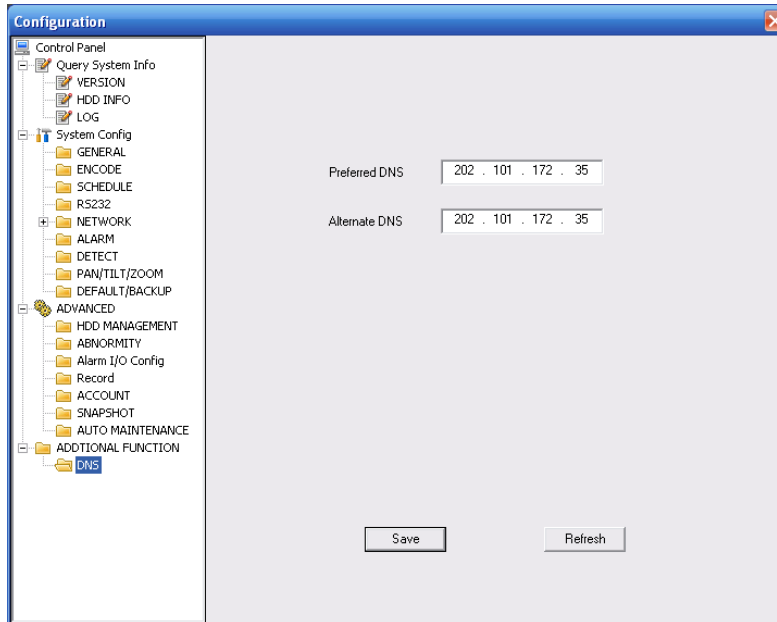

Figure 7-57

7.4 Search

Click search button, you can see an interface is shown in Figure 7-58.

Select record playback mode, and then select start time, end time and channel. Then click search button, you can see the corresponding files in the list.

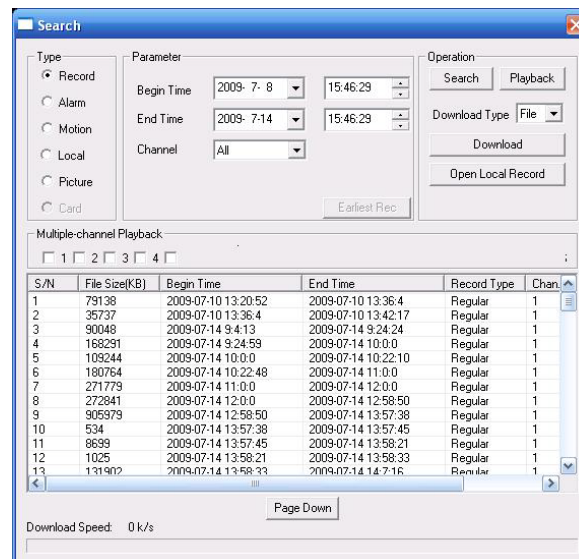

Figure 7-58

Select the file(s) you want to download and then click download button, system displays a dialogue box shown in Figure 7-59, then you can specify file name and path to download the file(s) to your local pc.

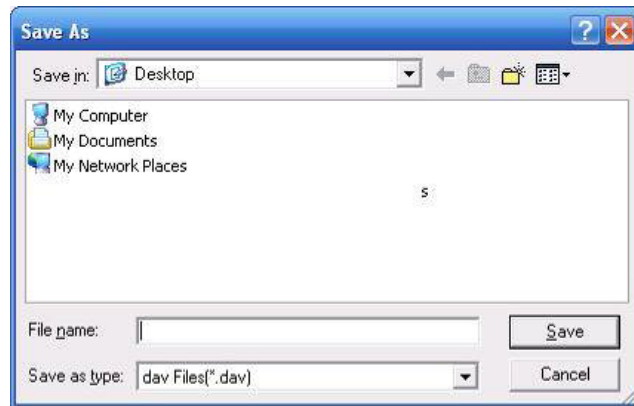

Figure 7-59

Now the system begins download and the download button becomes stop button. You can click it to terminate current operation.

At the bottom of the interface, there is a process bar for your reference. See Figure 7-60.

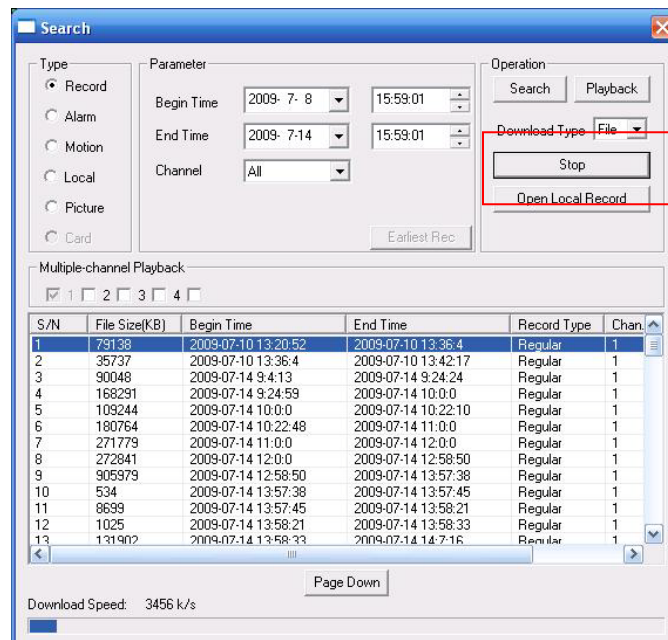

Figure 7-60

When download completes, you can see a dialogue box shown in Figure 7-61. Please click OK to exit.



Figure 7-61

Please refer to the following chart for detailed information.

	Parameter	Function
Type	Record	Search general record, alarm record and motion detection record.
	Alarm	Search alarm record.
	Motion Detection	Search motion detection record.
	Local	Search local record.
	Snapshot	Search snapshot file.
Item	Begin time	Set the file start time. You can select from the dropdown list.
	End time	Set the file end time. You can select from the dropdown list
	Channel	Select the channel from the dropdown list.
Operation	Search	Click this button you can view the recorded file matching your requirements. There are 100 files on one screen. You can use pg up/down button to view more files.
	Playback	Select the file first and then click playback button to view the video.
	Download type	Download by file: Select the file(s) and then click download button. Download by time: Download the recorded file(s) within your specified period.
	Download	Select the file you need (multiple choices) and then click download button, system displays a dialogue box. See Figure 7-53. Input the downloaded file name, specify the path and then click OK button. You can see system begins download and the download becomes stop button. There is a progress bar for your reference.
	Open local record	Select local record to play.
Multiple-channel playback		System supports playing back one file on 8 channels.

During the playback process, you can see there are control buttons such as play, pause, stop, slow play and fast play in the play process bar. You can view current playback file channel name, time and data statistics. In the search result interface, you can select one or more files to download to your local PC. The playback control bar is shown below. See Figure 7-62.

- 1: Play
- 2: Pause
- 3: Stop
- 4: Slow play
- 5: Fast play

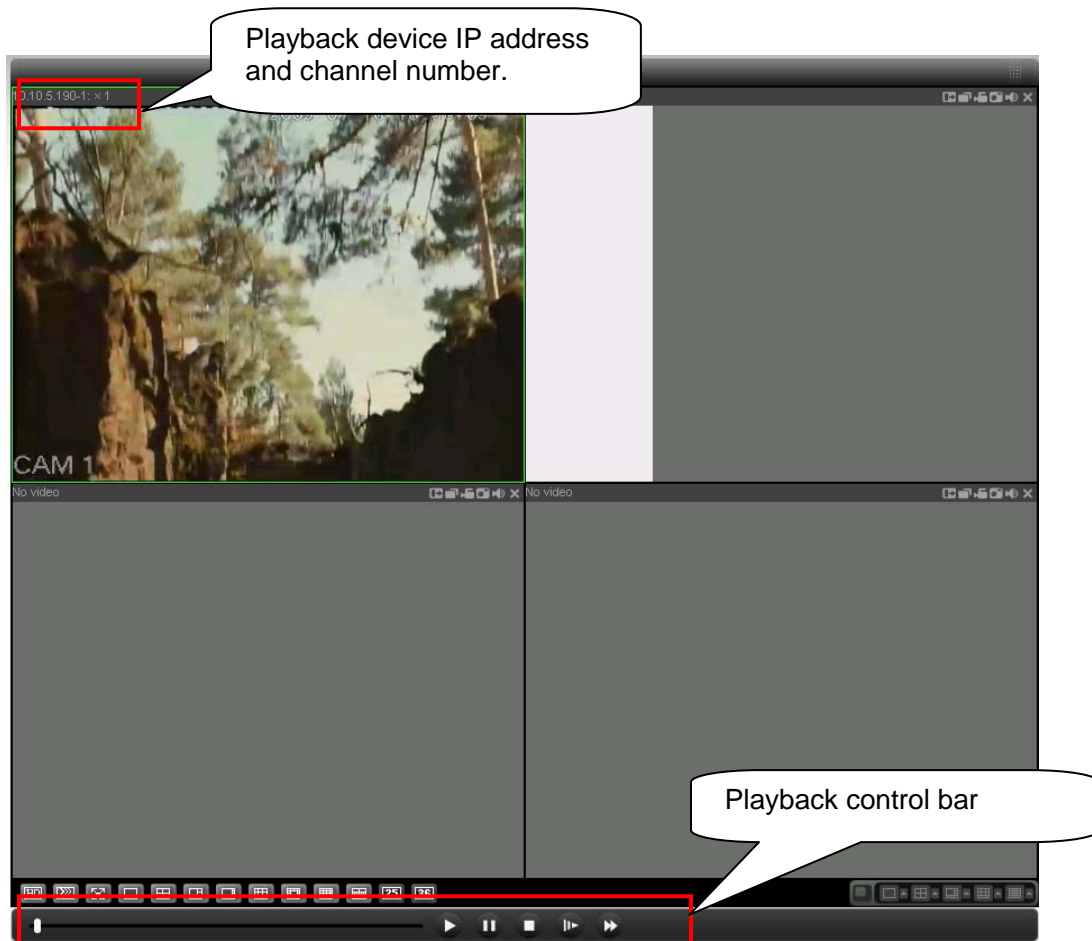

Figure 7-62

7.5 Alarm

Click alarm function, you will see the interface shown in Figure 7-63. Here you can set device alarm type and alarm sound setup.

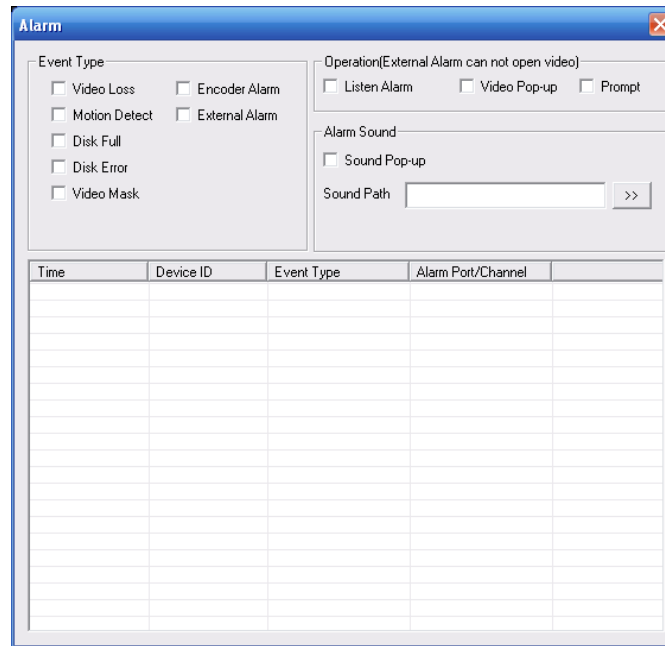

Figure 7-63

Please refer to the following chart for detailed information.
Please make sure current device can upload the alarm.

Type	Parameter	Function
Alarm Type	Video loss	System sends alarm when video loss occurs.
	Motion detection	System sends alarm when motion detection alarm occurs,
	Disk full	System sends alarm when disk is full.
	Disk error	System sends alarm when disk error occurs.
	Camera masking	System sends alarm when camera is viciously masked.
	Encode alarm	System sends alarm when peripheral device alarms.
	External alarm	Alarm input device sends out alarm.
Operation	Listen alarm	System notifies web when alarm occurs (you select from the above event type), and then web can notify user.
	Video	When alarm occurs, system auto enables video monitor. This function only applies to video detection alarm (motion detection, video loss and camera masking).
	Prompt	Automatically displays alarm dialogue box.
	Sound pop up	System sends out alarm sound when alarm occurs. You can specify as you wish.
	Path	Here you can specify alarm sound file.

7.6 About

Click about button, you can view current web client information. See Figure 7-64.

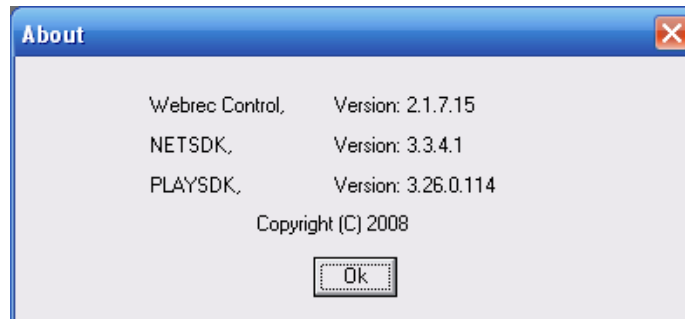

Figure 7-64

7.7 Log out

Click log out button, system goes back to log in interface. See Figure 7-65. You need to input user name and password to login again.

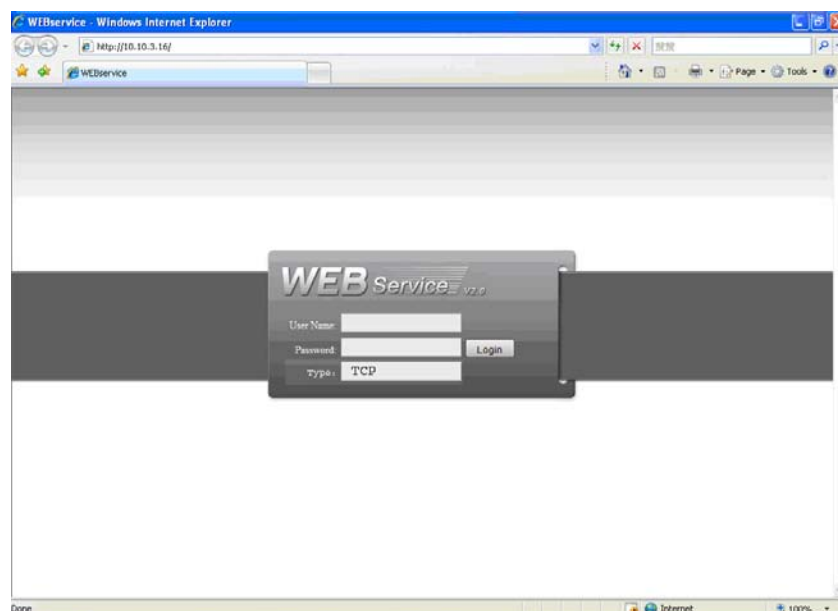

Figure 7-65

7.8 Un-install Web Control

You can use web un-install tool "uninstall web.bat" to un-install web control.

Please note, before you un-install, please close all web pages, otherwise the un-installing might result in error.

8. SETUP MYQ-SEE DDNS

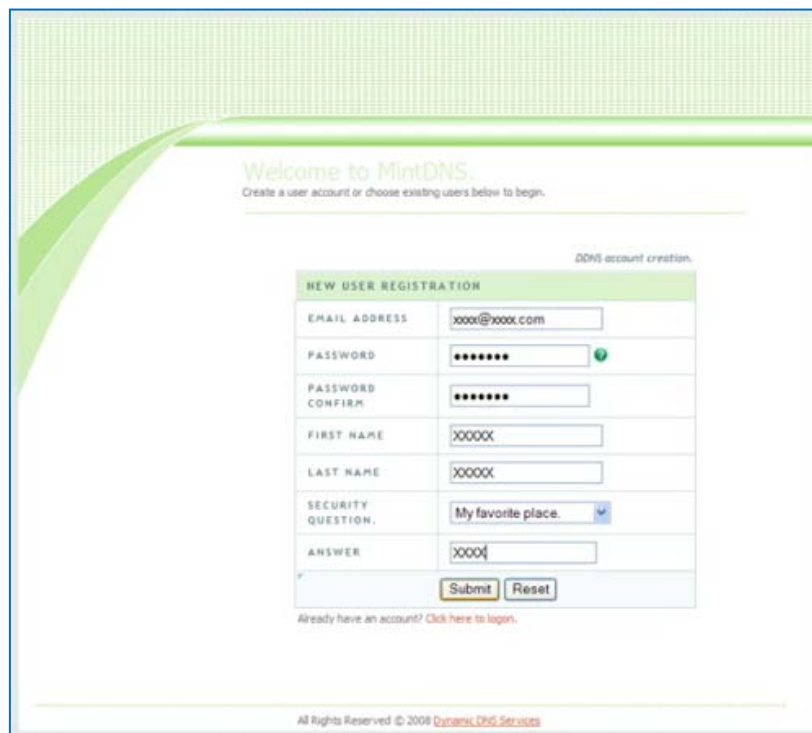

Dynamic Domain Name Service (DDNS) provides the capability for a networked device using the Internet Protocol Suite to notify a DDNS host to change the active DNS configuration of its hostnames or addresses. This is a useful feature that your Q-See DVR system is equipped with and can be helpful in avoiding any issues that might occur due to frequent or unplanned changes to your Public/WAN IP address. Enabling DDNS on your Q-See DVR system will allow you to connect to your device through a DDNS host such as myq-see.com. In order to facilitate this ability on your Q-See DVR system, you must first set up Port Forwarding as directed in the User Manual for this device. Once you have enabled Port Forwarding, you can configure your DDNS information by following these steps:

- Using a computer that is connected to the same network as your Q-See DVR, use your IE Browser to go to <http://myq-see.com>.
- Click on the New User? Link at the bottom of your page (<http://myq-see.com/reg.asp>).
- Complete the registration process by following the on-screen directions and click the [Submit] button at the bottom of your screen (Figure 8-1).



Welcome to MintDNS.
Create a user account or choose existing users below to begin.

DNS account creation.

NEW USER REGISTRATION	
EMAIL ADDRESS	<input type="text" value="xxxx@xxxx.com"/>
PASSWORD	<input type="password" value="*****"/> 
PASSWORD CONFIRM	<input type="password" value="*****"/>
FIRST NAME	<input type="text" value="XXXXX"/>
LAST NAME	<input type="text" value="XXXXX"/>
SECURITY QUESTION	<input type="text" value="My favorite place."/> 
ANSWER	<input type="text" value="XXXXX"/>
<input type="button" value="Submit"/> <input type="button" value="Reset"/>	

Already have an account? [Click here to login.](#)

All Rights Reserved © 2008 [Dynamic DNS Services](#)

Figure 8-1

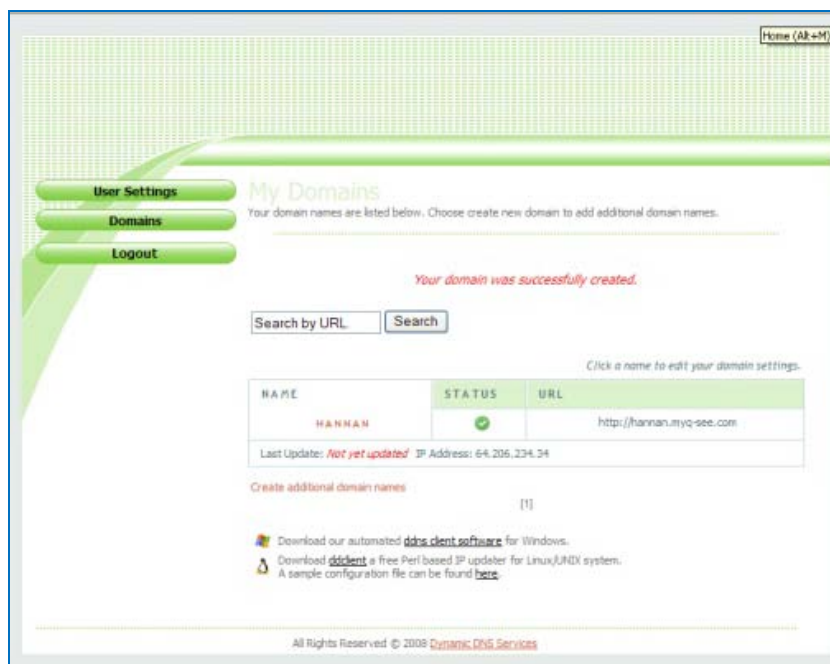

Figure 8-2

- d. The next screen will ask you to create a domain name. Domain names must start with an (a-z) or (0-9) and cannot contain a hyphen. Once you choose your domain name, click on the [Request Domain] button. This will generate a confirmation screen which tells you if your Domain name is available and list an IP address (Figure 8-2). Verify that this is your current IP Address by going to www.myipaddress.com and checking that it is the same address listed in your confirmation screen (Figure 2).
- e. Once you have completed steps a-d, go to the DVR and go to Menu→ Settings, Network (Figure 8-3).

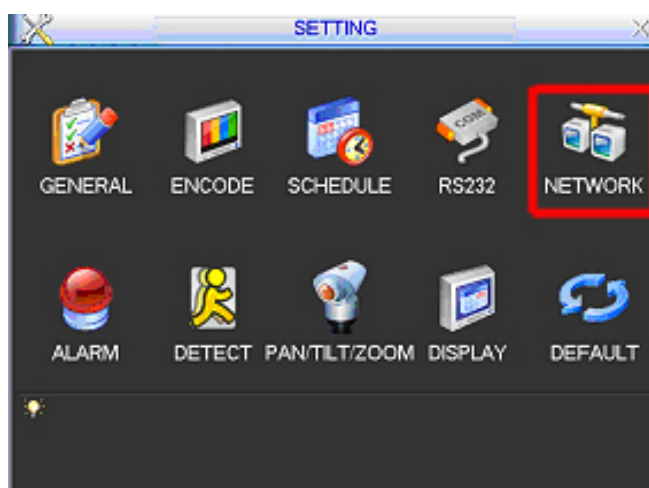

Figure 8-3

- f. Clicking on Network (RED box in Figure 8-3) will generate a Network settings dialog box as illustrated in Figure 8-4. Checking the [DDNS] box (RED box in Figure 7-4) will display a DDNS setting dialog box as illustrated in Figure 8-5.

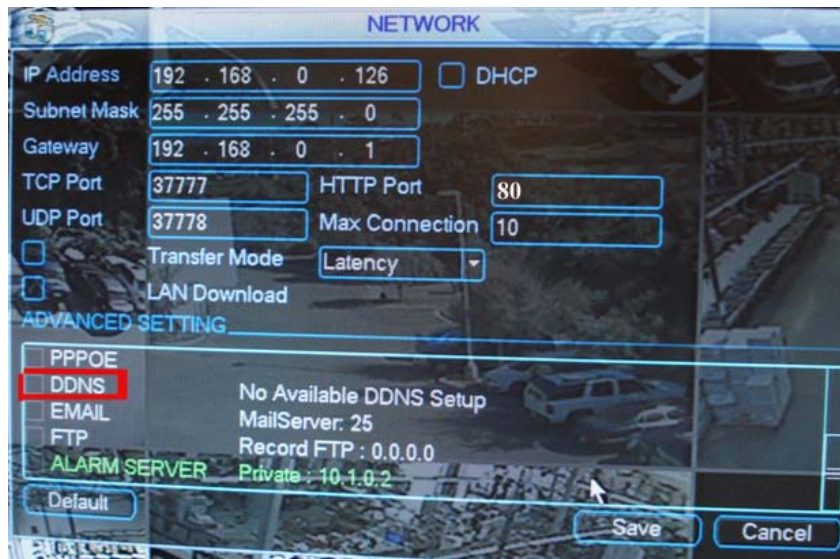

Figure 8-4

- g. Enter the User Name, Password and Domain Name that you registered for through <http://myq-see.com>. Click the [APPLY] button at the bottom of the screen and then the [EXIT] button. This should return you to the Network Setup menu.
- h. Click the [APPLY] button and then the [EXIT] button at the bottom of the Network Setup Screen and your DDNS setup is complete.



Figure 8-5

- DDNS Type: You can select Q-SEE DDNS from the dropdown list.
- Server IP: You can use ping command to get server's IP
- Port: input server port here.
- Domain Name: Get the domain name you get from your DDNS service provider.
- User: Get the user name you get from your DDNS service provider.
- Password: Enter corresponding password.

Highlight the icon in front of Enable to enable the DDNS server configuration.

9 SMARTPHONE ACCESS

This DVR supports access from Smart phones running Windows Mobile, Symbian, and Android operating systems as well as iPhones.

Make sure the network configuration has been setup on the DVR (refer to Chapter 5 section 5.3.5) and ports 80 and 37777 have been forwarded from the router the DVR is attached to, to the IP address of the DVR (refer to Chapter 7 section 7.1.1 on Port forwarding), and can be seen from internet using your PC.

Windows Mobile

- This software supports Windows Mobile OS (5.0 or higher); Please refer to the following brand list:
 - ✧ Dopod: C730, HTC Touch, HKC Pearl, HTC6800, HTC6900, HTC6850, P3450, P4550, S1, S420, S730, Touch ; , LG KC1, KS20, 830, 838, 900, Athena, C800(C858), CHT 9000, CHT 9100, D600, D802, D810, E806c, M700, MUSE, P800W, U1000 ;
 - ✧ Mio: A501 ; OKWAP K868 Plus, K869, A700 ;
 - ✧ ASUS: P526, P535, P735 ;
 - ✧ Holley: H8800 ; ;
 - ✧ Gigabyte: GSmart t600, i350, g-Smart, g-Smart i, i300 ;
 - ✧ Samsung: SGH-i718 ;
 - ✧ Lenovo: ET980, ET600, ET980T ;
 - ✧ Amoi: E850, E860, E870 ;
 - ✧ Gionee: S600 ;
 - ✧ Sharp: EM ONE ;
 - ✧ CoolPAD: 728, 728B, 768, 838G2 ;
 - ✧ HP: 6925, hw6828, iPAQ rw6818, rw6965 ;
 - ✧ UTStarcom: P903, XV6700 ;
 - ✧ Toshiba:G500 ; O2 Flame, Argon, Atom, Atom Life, Exec, mini S, XDA Neo, Orbi, Stealth ; i-mate JAMA, JAO3, JAQ, JAQ3, JAQ4, JASJAR, PDAL and etc.
 - ✧

To access the DVR running Windows Mobile you would install the General_DMSS-Mobile-Direct_Eng_N5_IS_V1.21.6.R.100203.cab file that is in the Windows folder on the CD included with the DVR. The folder also includes a User's Guide with instructions on how to install and use the program.

Symbian

- Technically speaking, based on the Symbian development manual, this software can support all Symbian S60_3rd OS mobile phones.
- Recommended S60_3rd FP2&FP1 mobile phone includes: NokiaN85, NokiaN82 and etc.

Important

- For Nokia Symbian S60_3rd base version and Nokia Symbian S60_3rd FP1 version, please download the s60plugins.rar file and install all three Nokia official plug-ins (glib.SIS /pips_nokia_1_3_SS.sis /stdcpp.SIS)
- If you can not use the monitoring software after installation, please connect your mobile phone to the Nokia PC Suite 7.1.26 (or higher), click the help menu. Then you need to select to install the PC Suite again. Please follow the instructions to install MMSSync suite program, and Contacts Group DS Plugin.

To access the DVR running Symbian you would copy General_DMSS-Symbian-Direct_Eng_IS_V1.21.6.R.100201.sis file that is in the Symbian folder on the CD included with the DVR to the phone. The folder also includes a User's Guide with instructions on how to install and use the program.

Android

Supported phones include: Gphone HTC , HTC G1, HTC Magic, HTC Hero, HTC G5.

To access the DVR from a phone running Android you would copy the DMMSV1.0.apk file that is in the Symbian folder on the CD included with the DVR to the phone. The folder also includes a User's Guide with instructions on how to install and use the program.

iPhone

From the IPHONE:

Open APP STORE

Search for DMSS, click FREE and click Install (you need to have itunes account)

After downloading follow the instructions in the iPhone folder on the CD included with the DVR.

10 TROUBLESHOOTING

1. Combo DVR does not boot up properly.

Possible causes:

- Input power is not correct, check power supply.
- Power switch button is damaged.
- Updated firmware using wrong file.
- Hard drive malfunction or something wrong with hard drive cable.
- Front panel error.
- Main board is damaged.

2. The LCD does not work after device boots up.

Possible causes:

- The screen is damaged during the transportation resulting from heavy vibration.
- You have pressed the M button, but there is no PC signal input. Please press M again to resume.
- The LCD connection is loose. Please contact Q-see for help.
- Updated firmware using wrong file.

3. Combo DVR often automatically shuts down or stops running.

Possible causes:

- Input voltage is not stable or it is too low.
- Hard drive malfunction or something is wrong with the cable.
- Device is not getting enough power.
- Front video signal is not stable.
- Working environment is too hot, or too much dust.
- System board malfunction.

4. System cannot detect hard drive.

Possible causes:

- No hard drive is installed
- Hard drive is damaged.
- Hard drive cable connection is loose.
- Main board SATA port is damaged.

5. There is no video output to one or more channels.

Possible causes:

- Updated firmware using wrong file.
- Brightness is 0. Please restore factory default setup.
- There is no video input signal or it is too weak.
- Check privacy mask setup or your screen saver.
- Combo DVR hardware malfunctions.

6. Real-time video color is distorted.

Possible causes:

- When using BNC output, NTSC and PAL setup is not correct. The real-time video becomes black and white.
- Combo DVR and monitor resistance is not compatible.
- Video transmission is too long signal is becoming degraded.
- Combo DVR color or brightness setup is not correct.

7. Cannot search local records.

Possible causes:

- HDD ribbon is damaged.
- HDD is broken.
- Upgraded program is not compatible.
- The recorded file has been overwritten.
- Record function has been disabled.

8. Video is distorted when searching local records.

Possible causes:

- Video quality setting is too low.
- Program read error, bit data is too small. There is mosaic in the full screen. Please restart the combo DVR to solve this problem.
- Hard drive data cable error.
- Hard drive malfunction.
- Combo DVR hardware malfunction.

9. There is no audio when monitoring.

Possible causes:

- Channel with audio is not full screen, make the channel you want to hear audio on full screen.
- Audio cable is damaged.
- Combo DVR hardware malfunction.

10. There is audio when monitoring but there is no audio when system plays back.

Possible causes:

- Setup is not correct. Please enable audio function
- Corresponding channel has no video input. Playback is not continuous when the screen is blue.

11. Time display is not correct.

Possible causes:

- Setup is not correct
- Battery contact is not correct or voltage is too low.
- Crystal is broken.

12. Combo DVR cannot control PTZ.

Possible causes:

- Front panel PTZ error
- PTZ decoder setup, connection or installation is not correct.
- Cable connection is not correct.
- PTZ setup is not correct.
- PTZ decoder and combo DVR protocol and/or address do not match.
- When there are several decoders, please add 120 Ohm between the PTZ decoder A/B cables furthest end to deter reverberation or impedance matching. Otherwise the PTZ control is not stable.
- The PTZ camera is too far from the DVR.

13. Motion detection function does not work.

Possible causes:

- Period setup is not correct.
- Motion detection zone setup is not correct.
- Sensitivity is too low.

14. Cannot log in client-end or web.

Possible causes:

- For Windows 98 or Windows ME user, please update your system to Windows 2000 sp4 or later. Or you can install client-end software of lower version.
- ActiveX control has not been enabled.
- Video card driver on computer may need to be upgraded.
- Network connection error.
- Network setup error.
- Password or user name is invalid.

15. There is only mosaic no video when previewing or playing back video file remotely.

Possible causes:

- Network bandwidth is not sufficient.
- Computer does not have enough resources to handle video flow.
- There is multiple-cast group setup in combo DVR. This mode can result in mosaic. Usually we do not recommend this mode.
- There is privacy mask or channel protection setup.
- Current user does not have monitoring rights.
- Combo DVR local video output quality is not good.

16. Network connection is not stable.

Possible causes:

- Network is not stable.
- IP address conflict.
- MAC address conflict.
- PC or combo DVR network card is not good.

17. Burn error /USB backup error.

Possible causes:

- Burner and combo DVR are in the same data cable.
- System uses too much CPU resources. Try stopping recording first and then begin backup.
- Data amount exceeds backup device capacity. It may result in burner error.
- Backup device is not compatible.
- Backup device is damaged.

18. Keyboard cannot control combo DVR.

Possible causes:

- Combo DVR serial port setup is not correct
- Address is not correct
- When there are several switchers, power supply is not enough.
- Transmission distance is too long.

19. Alarm signal cannot be disarmed.

Possible causes:

- Alarm setup is not correct.
- Alarm output has been opened manually.
- Input device error or connection is not correct.

20. Alarm function is not working.

Possible causes:

- Alarm setup is not correct.
- Alarm cable connection is not correct.
- Alarm input signal is not correct.
- There are two loops connected to one alarm device.

21. Remote control does not work.

Possible causes:

- Need to enter the correct Device ID on the remote control.
- Distance is too far or control angle is too small.
- Remote control battery power is low.
- Remote control is damaged or combo DVR front panel is damaged.

22. Can not playback the downloaded file.

Possible causes:

- There is no media player.
- Need Divx Codec in file player

23. Forgot local menu operation password or network password

- Contact Q-See tech support and we can generate a new password for the unit.

Daily Maintenance

- The device needs to be soundly grounded to avoid audio/video disturbance. Keep the device away from static electricity or induced voltage.
- Unplug the power cable before you remove the audio/video signal cable, RS232 or RS485 cable.
- Always shut down the device properly. Please use the shutdown function in the menu, or you can press the power button on the front panel for at least three seconds to shut down the device. Otherwise it may result in hard drive malfunction.
- Make sure the device is away from direct sunlight or other heating sources. Please keep the ventilation fans clear.
- Please check and maintain the device regularly.

Appendix A: HDD Capacity Calculation

Calculate total capacity needed by each DVR according to video recording (video recording type and video file storage time).

Step 1: According to Formula (1) to calculate storage capacity q_i that is the capacity of each channel needed for each hour, unit Mbyte.

$$q_i = d_i \div 8 \times 3600 \div 1024 \quad (1)$$

In the formula: d_i means the bit rate, unit Kbit/s

Step 2: After video time requirement is confirmed, according to Formula (2) to calculate the storage capacity m_i , which is storage of each channel needed unit Mbyte.

$$m_i = q_i \times h_i \times D_i \quad (2)$$

In the formula:

h_i means the recording time for each day (hour)

D_i means number of days for which the video shall be kept

Step 3: According to Formula (3) to calculate total capacity (accumulation) q_T that is needed for all channels in the DVR during **scheduled video recording**.

$$q_T = \sum_{i=1}^c m_i \quad (3)$$

In the formula: c means total number of channels in one DVR

Step 4: According to Formula (4) to calculate total capacity (accumulation) q_T that is needed for all channels in DVR during **alarm video recording (including motion detection)**.

$$q_T = \sum_{i=1}^c m_i \times a\% \quad (4)$$

In the formula: % means alarm occurrence rate

Appendix B: Compatible USB Drive List

NOTE: USB Drives that we have tested successfully with the combo DVR.

Manufacturer	Model	Capacity
Sandisk	Cruzer Micro	512M
Sandisk	Cruzer Micro	1G
Sandisk	Cruzer Micro	2G
Sandisk	Cruzer Freedom	256M
Sandisk	Cruzer Freedom	512M
Sandisk	Cruzer Freedom	1G
Sandisk	Cruzer Freedom	2G
Kingston	DataTraveler II	1G
Kingston	DataTraveler II	2G
Kingston	DataTraveler	1G
Kingston	DataTraveler	2G
Maxell	USB Flash Stick	128M
Maxell	USB Flash Stick	256M
Maxell	USB Flash Stick	512M
Maxell	USB Flash Stick	1G
Maxell	USB Flash Stick	2G
Kingax	Super Stick	128M
Kingax	Super Stick	256M
Kingax	Super Stick	512M
Kingax	Super Stick	1G
Kingax	Super Stick	2G
Netac	U210	128M
Netac	U210	256M
Netac	U210	512M
Netac	U210	1G
Netac	U210	2G
Teclast	Ti Cool	128M
Teclast	Ti Cool	256M
Teclast	Ti Cool	512M
Teclast	Ti Cool	1G
Teclast	Ti Cool	2G

Appendix C: Compatible CD/DVD Burner List

NOTE: Drives tested successfully with the combo DVR. Please confirm the drive is formatted as FAT32.

Manufacturer	Model	Port Type	Type
Sony	DRX-S50U	USB	DVD-RW
Sony	DRX-S70U	USB	DVD-RW
Sony	AW-G170S	SATA	DVD-RW
Samsung	TS-H653A	SATA	DVD-RW
Panasonic	SW-9588-C	SATA	DVD-RW
Sony	DRX-S50U	USB	DVD-RW
BenQ	5232WI	USB	DVD-RW

Appendix D: Compatible SATA HDD List

NOTE: SATA drives that we have tested successfully with the combo DVR

Manufacturer	Series	Model	Capacity	Port Mode
Seagate	Barracuda.10	ST3750640AS	750G	SATA
Seagate	Barracuda.10	ST3500630AS	500G	SATA
Seagate	Barracuda.10	ST3400620AS	400G	SATA
Seagate	Barracuda.10	ST3320620AS	320G	SATA
Seagate	Barracuda.10	ST3250620AS	250G	SATA
Seagate	Barracuda.10	ST3250820AS	250G	SATA
Seagate	Barracuda.10	ST3160815AS	160G	SATA
Seagate	Barracuda.10	ST380815AS	80G	SATA
Seagate	Barracuda.9	ST3160811AS2	160G	SATA
Seagate	Barracuda.9	ST3120811AS2	120G	SATA
Seagate	Barracuda.9	ST380811AS2	80	SATA
Seagate	Barracuda.9	ST380211AS2	80G	SATA
Seagate	Barracuda.11	ST3750330AS	750G	SATA
Seagate	Barracuda.11	ST3500320AS	500G	SATA
Seagate	Barracuda 7200.11	ST31500341AS	1.5T	SATA
Seagate	Pipeline HD.2	ST3320311CS	350G	SATA
Seagate	SV35.2	ST3160815SV	160G	SATA
Seagate	SV35.2	ST3250310SV	250G	SATA
Seagate	SV35.2	ST3320620SV	320G	SATA
Seagate	SV35.2	ST3500320SV	500G	SATA
Seagate	SV35.2	ST3750640SV	750G	SATA
Seagate	SV35.3	ST31000340SV	1T	SATA
Maxtor	DiamondMax 20	STM3320820AS	320G	SATA
Maxtor	DiamondMax 20	STM3250820AS	250G	SATA
Maxtor	DiamondMax 21	STM3160211AS	160G	SATA
Maxtor	DiamondMax 21	STM380211AS	80G	SATA
Maxtor	DiamondMax 21	STM340211AS	40G	SATA
Western Digital	Caviar SE	WD3200JD	320G	SATA
Western Digital	Caviar SE	WD3000JD	300G	SATA
Western Digital	Caviar SE	WD2500JS	250G	SATA
Western Digital	Caviar SE	WD2000JD	200G	SATA
Western Digital	Caviar SE	WD1600JD	160G	SATA
Western Digital	Caviar SE	WD1600JS	160G	SATA
Western Digital	Caviar SE	WD1200JS	120G	SATA
Western Digital	Caviar SE	WD800JD	80G	SATA

Manufacturer	Series	Model	Capacity	Port Mode
Western Digital	Caviar	WD1600AABS2	160G	SATA
Western Digital	Caviar	WD800BD	80G	SATA
Western Digital	Caviar SE16	WD7500KS2	750G	SATA
Western Digital	Caviar SE16	WD5000KS2	500G	SATA
Western Digital	Caviar SE16	WD4000KD2	400G	SATA
Western Digital	Caviar SE16	WD3200KS2	320G	SATA
Western Digital	Caviar SE16	WD2500KS2	250G	SATA
Western Digital	RE series	WD5000ABYS	500G	SATA
Western Digital	Caviar Green series	WD20EADS	2T	SATA
Samsung	/	HA101UJ/CE	1T	SATA

Free Manuals Download Website

<http://myh66.com>

<http://usermanuals.us>

<http://www.somanuals.com>

<http://www.4manuals.cc>

<http://www.manual-lib.com>

<http://www.404manual.com>

<http://www.luxmanual.com>

<http://aubethermostatmanual.com>

Golf course search by state

<http://golfingnear.com>

Email search by domain

<http://emailbydomain.com>

Auto manuals search

<http://auto.somanuals.com>

TV manuals search

<http://tv.somanuals.com>