

# GX

## User Manual

**GX3 300 watts per channel at 8 ohms**

**GX5 500 watts per channel at 8 ohms**

EN



## IMPORTANT SAFETY PRECAUTIONS AND EXPLANATION OF SYMBOLS

- EN**
- 1- Read these instructions.
  - 2- Keep these instructions.
  - 3- Heed all warnings.
  - 4- Follow all instructions.
  - 5- **WARNING:** To prevent fire or electric shock, do not expose this equipment to rain or moisture. Do not use this apparatus near water.
  - 6- Clean only with a dry cloth.
  - 7- Do not block any ventilation openings. Install in accordance with the manufacturer's instructions.
  - 8- Do not install near any heat sources such as radiators, heat registers, stoves, or other apparatus (including amplifiers) that produce heat.
  - 9- The appliance coupler is the AC mains disconnect and should remain readily operable after installation.
  - 10- Do not defeat the safety purpose of the grounding-type plug. A grounding plug has two blades and a grounding prong. The wide blade or third prong are provided for your safety. If the provided plug does not fit your outlet, consult an electrician for the replacement of the obsolete outlet. This apparatus should be connected to a receptacle with a protective earthing (or ground) connection.
  - 11- Protect the power cord from being walked on or pinched, particularly at plugs, convenience receptacles, and the point where they exit from the apparatus.
  - 12- Use only attachments/accessories specified by QSC Audio Products, Inc.
  - 13- Use only with hardware, brackets, stands, and components sold with the apparatus or by QSC Audio Products, Inc.
  - 14- Unplug the apparatus during lightning storms or when unused for long periods of time.
  - 15- Refer all servicing to qualified service personnel. Servicing is required when the apparatus has been damaged in any way, such as power supply cord or plug is damaged, liquid has been spilled or objects have fallen into the apparatus, the apparatus has been exposed to rain or moisture, does not operate normally, or has been dropped.



The exclamation point within an equilateral triangle is intended to alert the user to the presence of important operating and maintenance (servicing) instructions in this manual.



The lightning flash with arrowhead symbol within an equilateral triangle is intended to alert the user to the presence of uninsulated "dangerous" voltage within the product's enclosure that may be of sufficient magnitude to constitute a risk of electric shock to humans.



**CAUTION: TO REDUCE THE RISK OF ELECTRIC SHOCK, DO NOT REMOVE THE COVER. NO USER-SERVICEABLE PARTS INSIDE. REFER SERVICING TO QUALIFIED PERSONNEL.**



**WARNING:** To prevent fire or electric shock, do not expose this equipment to rain or moisture.

© Copyright 2007, QSC Audio Products, Inc.

QSC® is a registered trademark of QSC Audio Products, Inc.

"QSC" and the QSC logo are registered with the U.S. Patent and Trademark Office

All trademarks are the property of Speakon® and PowerCon® are registered trademarks of Neutrik Inc. their respective owners.

### WELCOME

Thank you for purchasing a QSC Audio amplifier. The GX Series is the latest in a long line of hard-working, low cost amplifiers, designed to produce the best possible results for a wide range of users. In most cases, you can plug and play with no surprises, but for best results, we recommend you review the enclosed user guide.

### UNPACKING

Confirm that the amplifier has no visible shipping damage. Confirm that amplifier has the correct AC cord and voltage rating for your region (See rear panel, Serial Number plate). It is best to keep the carton in case the amplifier needs to be returned, at least until it has been tested.

### SUPPORT AND SERVICE

QSC Audio Products maintains a world-wide network of distributors and service centers. These local agencies will be able to answer your questions and take care of any problems.

### QSC WEBSITE

Our website, [www.qscaudio.com](http://www.qscaudio.com), is factory-maintained and supported in multiple languages. Visit frequently for new announcements, typical questions, and other user information.

### IMPORTANT SAFETY PRECAUTIONS

QSC products are designed for safe operation, and have been certified by recognized product safety agencies to meet all normal standards for this type of product. However, dangerous voltages and power levels exist within the covers of this amplifier. The user is requested to study the precautions in this manual. If the product has been dropped, dented, soaked, or appears to have loose parts inside, the risk of shock is increased. Unplug the AC cord, and take the product to qualified service personnel for inspection and repairs.

### POWER RATINGS

Watts at 0.1% clipping, both channels driven

Model	8 ohms	4 ohms	2 ohms*
GX3	300	425	200
GX5	500	700	350

\*NOTE: 2-ohm loading is not recommended for high power use. To avoid protective limiting, use only at low levels.



EN

### FEATURES

Power levels matched to the most popular speakers used by entertainers.

Optimized for maximum real-world headroom into 4Ω and 8Ω speaker systems.

Inputs: XLR, 1/4" TRS and phono input connectors for compatibility with any source.

Outputs: Speakon® combo accepts 1/4" (TS) plugs or Speakon 2-pole and 4-pole plugs (connects 2 poles only). Binding posts support all other speaker wiring systems.

Minimum depth chassis (only 10.1" / 257 mm) fits in compact, inexpensive effects racks.

Light weight – less than 26 lbs (12.5 kg).

Detented gain controls for precise setting and matching of sensitivity.

GuardRail automatically protects the amplifier and loudspeakers from damage due to temperature rise or overdrive without shutting down the show.

Front panel LEDs monitor Power, Signal and Clipping.

Subwoofer / Satellite crossover built-in.

# FRONT PANEL FEATURES

## ON-OFF SWITCH

Move the rocker switch up to turn on the amplifier.  
 The blue PWR LED will turn on immediately.  
 The red CLIP LEDs may trigger for 1-2 seconds until the amp has completed its turn-on cycle. If no lights come on, check the power cord and the AC reset on the rear panel.

## MODEL NUMBER

The GX3 and GX5 power ratings are shown in the Specifications page.

## COOLING VENTS

The internal fan draws air in from the left side, and exhausts on the right side. Keep vents clear.  
 The fan speeds up in response to heavy use.

EN

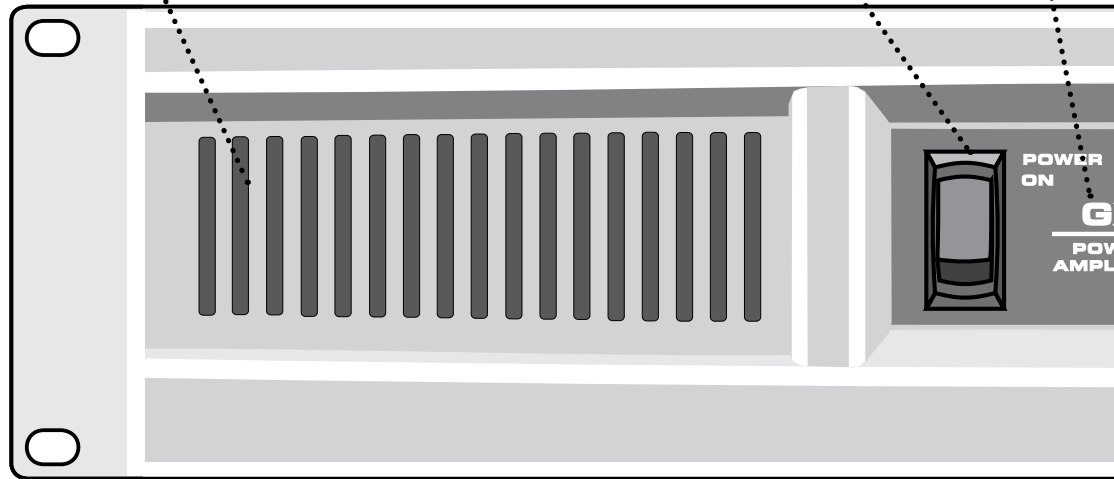

## DIMENSIONS

Inches (cm)

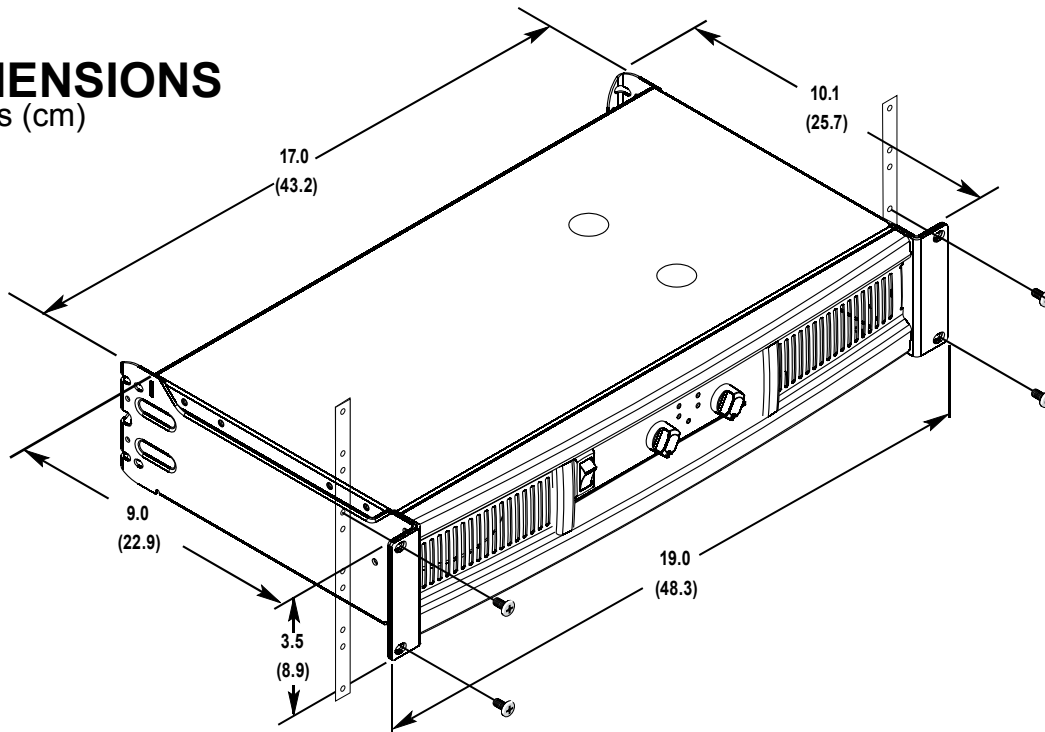

### GAIN CONTROLS, CH1, CH2

The markings show attenuation in dB. For normal use, keep the control in the upper half of its range (less than 10 dB of attenuation). If set below half, the source may overload before the amplifier reaches full power.

### RACK MOUNTING

Fits standard 19-inch rack, 2RU.  
Accepts #10 or 6 mm screws, as determined by the rack rails.  
Add rear support to prevent damage in portable rigs.

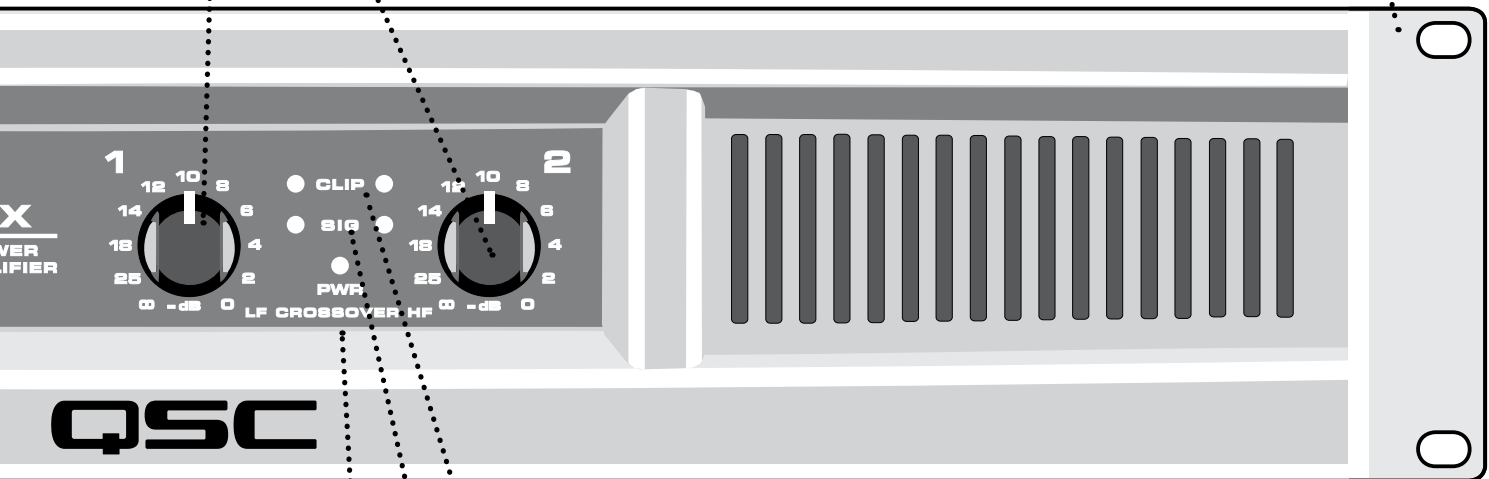

### RED CLIP LEDS

Red flashing indicates the amp is being overdriven. Heavy overdrive triggers internal gain reduction, to reduce overload distortion. Normal gain will resume after the signal level returns to normal. See Troubleshooting if the red LED remains on continuously.

### GREEN SIGNAL LEDS

The green LED starts flashing on soft signals (-35 dB), and changes to steady green as the signal level increases.

### BLUE POWER LED

The blue PWR (POWER) LED indicates that the AC switch is on, and the amp is receiving power. Within two seconds, it is ready to use.

### ALTERNATE GAIN MARKING

When the CROSSOVER switch is active (see rear panel), LF (CH 1) controls low frequencies (subwoofer), HF (CH 2) controls the high frequencies (mid-high box).

EN

# GX

# REAR PANEL FEATURES

## CROSSOVER SWITCH

### CROSSOVER POSITION

Splits a full-range signal to drive a subwoofer and top box. CH 1 receives the lows, from 20-100Hz, for the subwoofer. CH 2 receives 100Hz to 20kHz, to power a full range speaker. When using CROSSOVER mode, connect signal to CH 1 only. Use the two Gain controls to balance the LF and HF signals (see Front Panel).

### FULL RANGE POSITION

For normal, 2-channel use with all inputs active. The crossover is bypassed.

## EXHAUST VENT

Keep vent clear. Install in open-back rack.

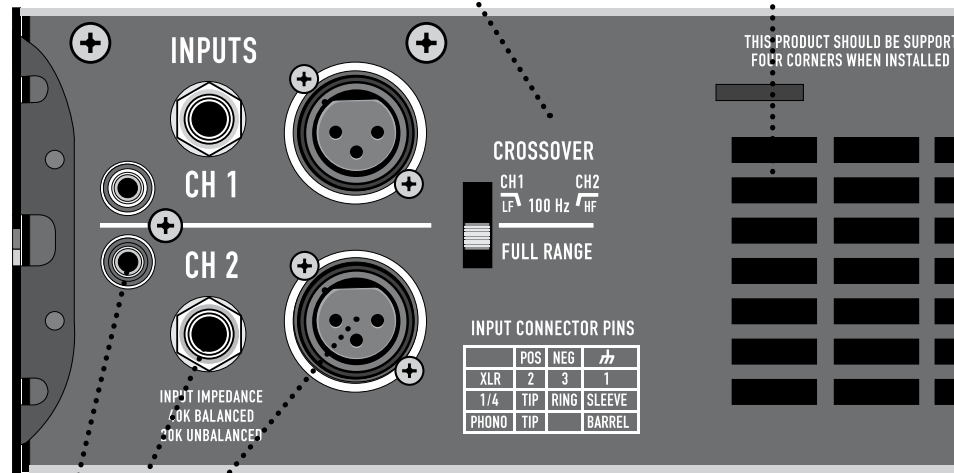

## REAR EAR MOUNTING

Rear ears designed for protecting the rear connector wire dressing and supporting the amplifier in a rack. A rear rack support mounting kit (model FG-000031-00 pack of two) is available from QSC Technical Services Group.

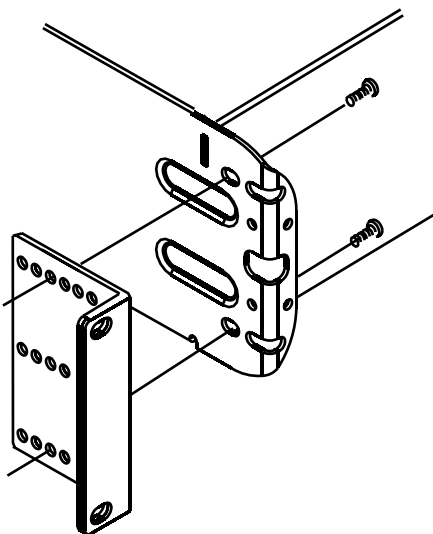

## INPUT CONNECTIONS

### BALANCED XLR INPUTS

Pin 2 Positive, Pin 3 Negative, Pin 1 Shield (Ground). Recommended for long or short runs, either fixed or frequently changed. Each channel's XLR and TRS jacks are connected internally, and provide feed thru to the other connector.



### BALANCED 1/4-INCH TRS INPUTS

Tip positive, Ring Negative, Sleeve Shield (Ground). Recommended for long or short runs that are frequently changed.



### UNBALANCED 1/4-INCH TS INPUTS

Accepts unbalanced 1/4-inch plugs for short runs. Tip positive, Sleeve Shield (Ground).



### UNBALANCED PHONO INPUTS

Tip Positive, Barrel Shield (Ground). Recommended for semi-permanent connections to nearby sources, within the same rack. NOTE: when using these inputs, the TRS or XLR inputs should not be used.



**AC BREAKER RESET** .....

If the amplifier shuts off after a long burst of power, turn off the AC switch and check the circuit breaker. The button can be pressed back in after a 30 second cool-down period. If the breaker trips repeatedly, the amplifier may need servicing.

**SERIAL NUMBER AND RATINGS** ....

The rated AC voltage and output power is shown on the serial number plate. Record the serial number in a safe place.

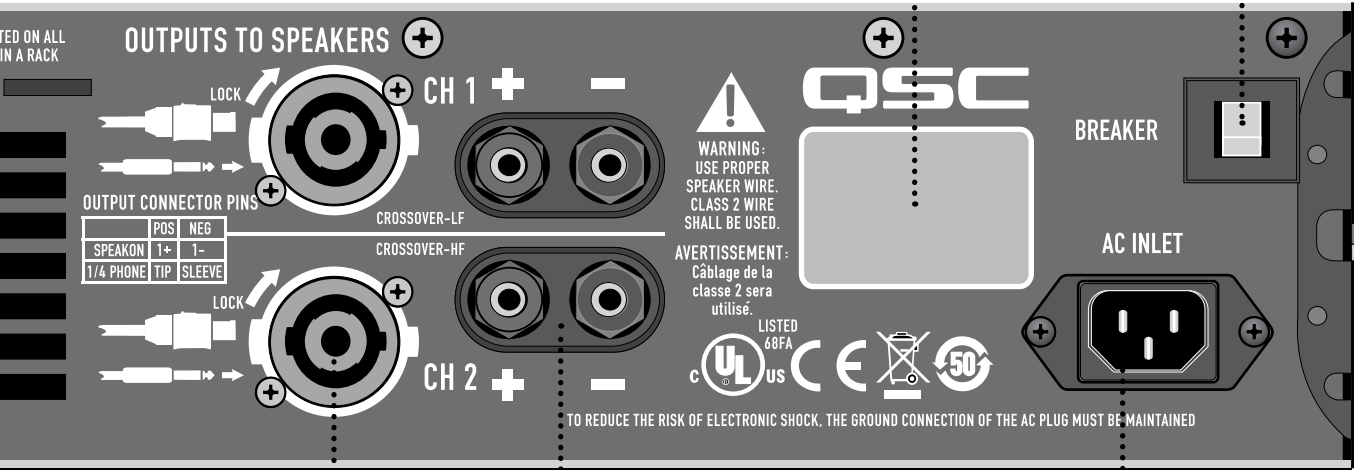

EN

**SPEAKER CONNECTIONS**

**BINDING POSTS**

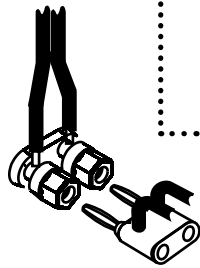

Accepts banana plugs (not permitted in CE regions). Bare wires or terminals may be inserted into the side holes.

**1/4-INCH CONNECTORS**

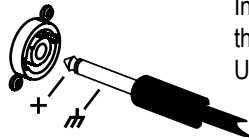

Insert plug into the center of the Speakon-Combo jack. Use only heavy duty speaker cables.

**SPEAKON CABLES (2 wire type):**

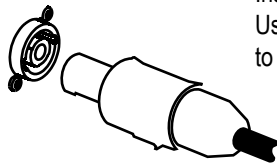

Insert and turn until the connector clicks. Use the thumb latch or locking ring to release the plug.

**AC INLET**

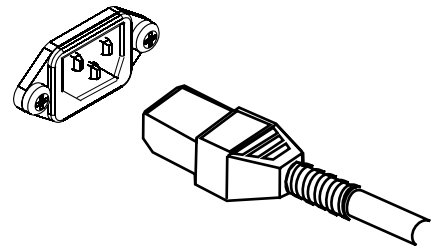

# SYSTEM HOOKUP EXAMPLES

## INPUT CONNECTIONS

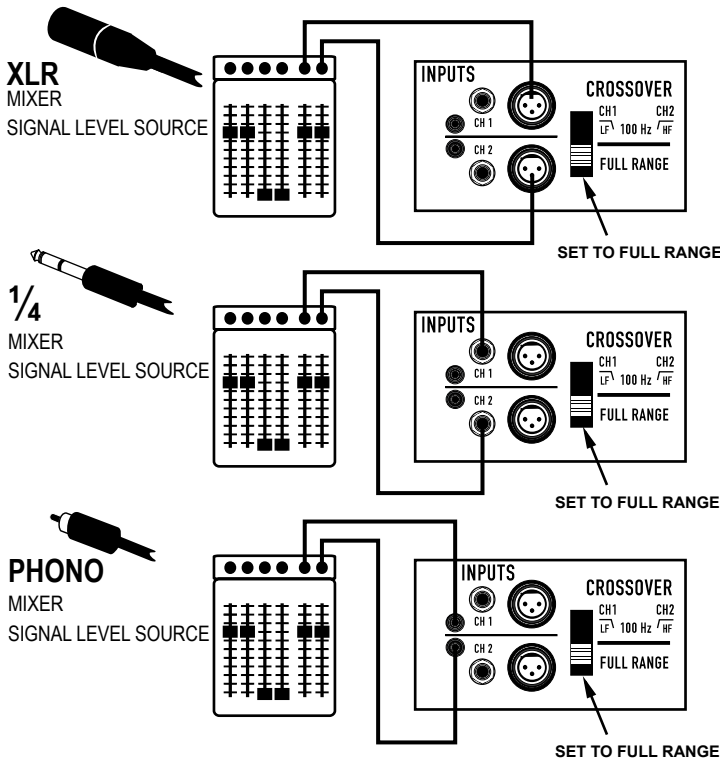

## SPEAKER CONNECTIONS

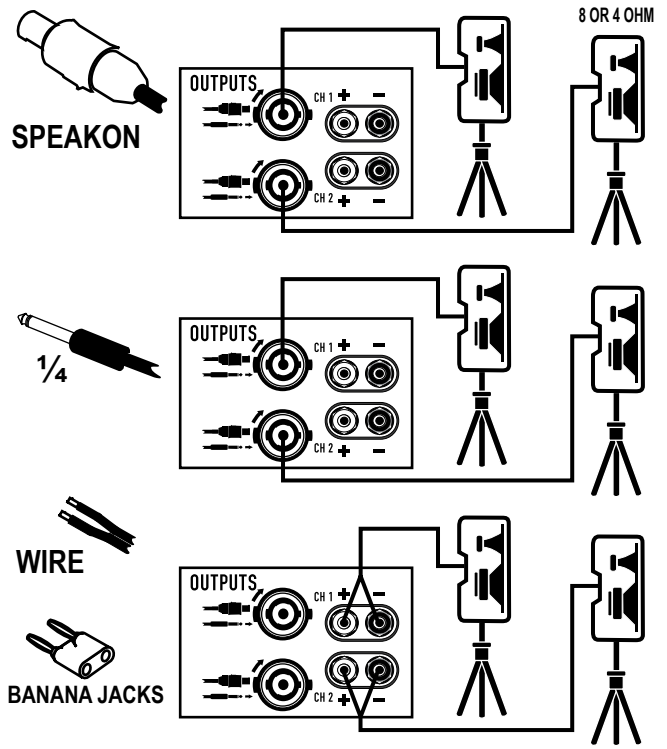

## CONNECTION MULTIPLE SPEAKERS

To connect two speakers to one amplifier channel, connect one speaker with Speakon or 1/4 -inch jack, and connect the other speaker with a banana plug or wires to the binding posts. It is also possible to use banana plug for one speaker, and binding post wires for the other speaker.

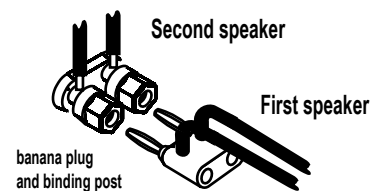
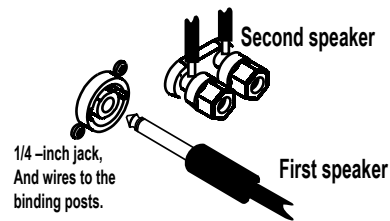
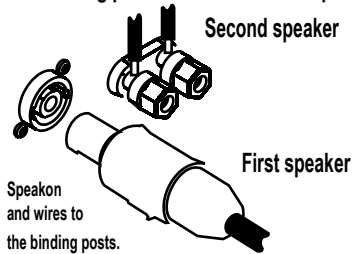

One 4-OHM speaker, or two 8-OHMspeakers, may be connected to each channel. If speakers have pass through jacks, do not put more than two in a chain.

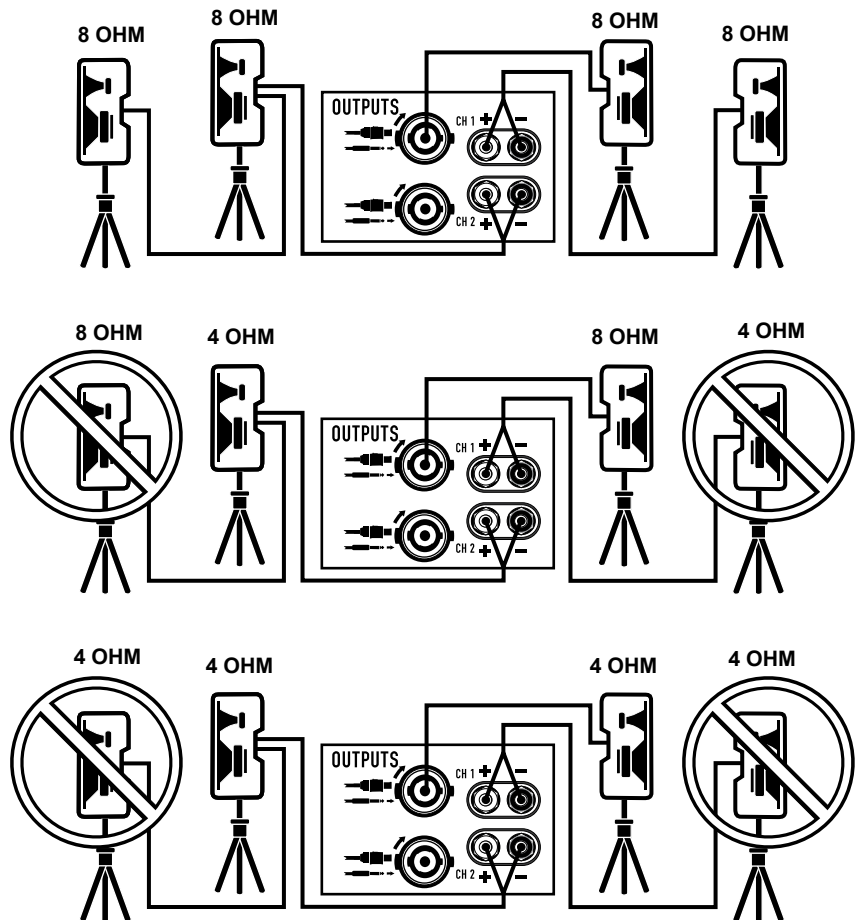



# SYSTEM HOOKUP EXAMPLES

## SUBWOOFER AND TOP BOX

Move the CROSSOVER switch to the CROSSOVER position.  
 Connect a single source, into the Ch 1 input.  
 Connect a subwoofer to the Ch 1 output and connect a 2-way to box to the Ch 2 output.

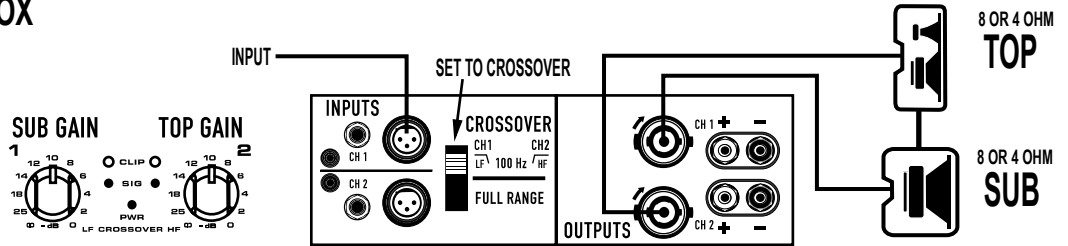

## POWERING HOUSE AND MONITOR SPEAKERS

Set the CROSSOVER switch to the FULL RANGE position.  
 Use a mixer with Main and Monitor outputs. Connect cables into Ch 1 and 2 respectively.  
 Connect Ch 1 output to two large speakers.  
 Connect Ch 2 output to two floor wedges.

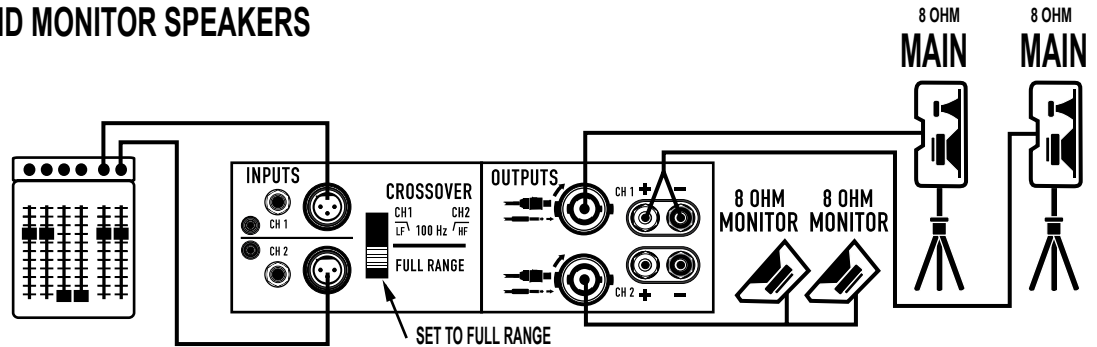

## STEREO PLAYBACK

Set the CROSSOVER switch in the FULL RANGE position. Connect a Left / Right signal source to channel 1 and channel 2 respectively using XLR, TRS or PHONO connectors.  
 Connect a speaker to each channel using SPEAKON, 1/4' PHONE, BANANA JACKS or WIRE.

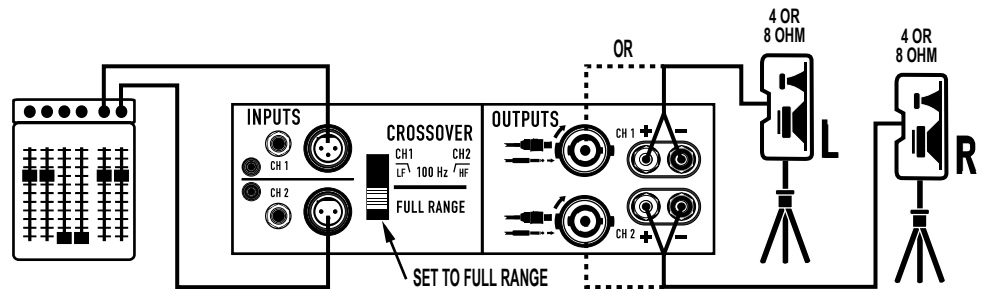

## USING BOTH CHANNELS FOR THE SAME

Move the CROSSOVER switch to the FULL RANGE position. Hook up a single source using Ch 1 XLR input. Install a RTS jumper going between Ch1 and Ch2.  
 Connect a speaker to each channel.  
 Each speaker has its own gain adjustment on the front panel.  
 DO NOT connect both channels into the same speaker.

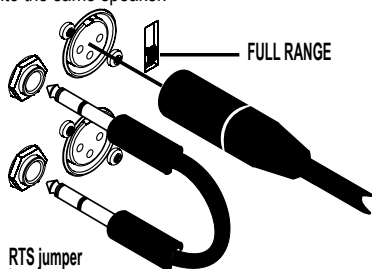
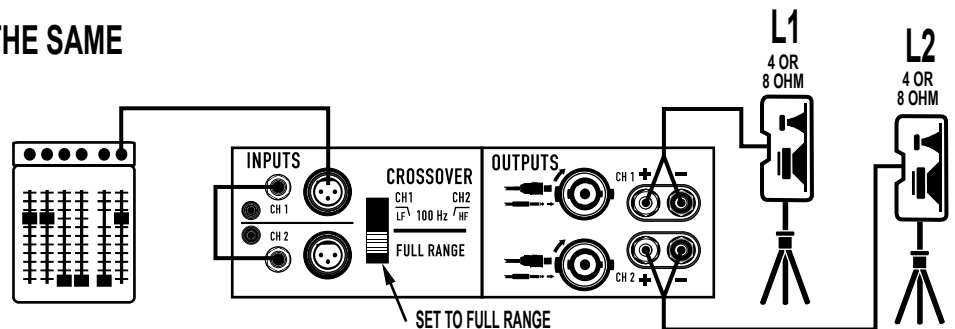

RTS jumper between CH1 and CH2



DO NOT connect both Channels to the same speaker.

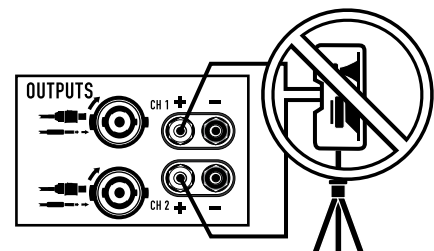

## TROUBLESHOOTING

### NO POWER, NO LIGHTS, NO FAN

Confirm that the AC cord is fully seated and connected to a live outlet. Check the AC source by trying another device such as a lamp. Check the BREAKER on the back of the amplifier by pushing in the button. If the breaker trips off quickly, the amplifier needs servicing.

### AMPLIFIER LOSES VOLUME

If the amplifier is worked too hard, GuardRail™ will reduce volume to prevent thermal muting. The fan should be running at full speed. Reduce input signal somewhat and the amp should return to normal gain within 1-2 minutes. If the amp feels hot and the fan is not running, it needs to be serviced.

### CHANNEL 1 PRODUCES DEEP BASS ONLY.

Check the position of the CROSSOVER switch on the rear panel. Set on FULL RANGE for normal, independent use of each channel.

### CHANNEL 2 INPUT SEEMS DEAD.

Check the position of the CROSSOVER switch on the rear panel. Set on FULL RANGE for normal, independent use of each channel.

### AMPLIFIER SOUNDS DISTORTED.

If the red CLIP LED is flashing, the amplifier is being played beyond its normal rated power. GuardRail™ circuitry will reduce volume somewhat to prevent severe overdrive, but if the input signal is further increased, the limiter can be overridden, with increased distortion.

If the speakers or speaker cables are shorted or defective, the amplifier may distort at lower-than-normal levels, with increased flashing of the red CLIP LED. This should be checked by trying an alternate speaker and cable.

If too many speakers are connected to each channel (impedance below 4 ohms), the amp will overload more easily and will probably run hot.

If the sound is distorted or garbled without flashing the red CLIP LED, the distortion is not occurring inside the amplifier. Either the speaker is bad or the input signal is distorted.

- Confirm that the speaker is OK by trying a different unit.
- Input overload can occur if the amplifier Gain controls are set too low, and the input source is overdriven to compensate. Reduce the source volume until the distortion clears up, and increase amp Gain to reach the desired level. It is generally desirable to keep the amp gains at or near their full, clockwise, position.
- Check all input connections. Do not plug two different sources into the same channel. Use a mixer to blend sources.

### NO SOUND, WITH BLUE LED ONLY, NO GREEN OR RED LED

Confirm that the Gain controls are turned up. Confirm that the input cables are correctly installed at both ends. If using 1/4-inch speaker cables, do not confuse with input cables. Confirm that the source is active. If necessary, try another source, or connect another amplifier to the existing source.

### NO SOUND, BUT THE GREEN LED IS RESPONDING

The green LED indicates the amp is producing a signal, so sound should be heard if the speaker is connected. Check the speaker connections at both ends, and try a different speaker.

### NO SOUND, RED LED ON

The amp mutes briefly when turned on and off to prevent thumps. If the amp overheats severely, it will mute until it cools off. The fan will be running at full speed, and sound should resume in less than a minute. If the amp feels hot and the fan is not running, it needs to be serviced.

### BACKGROUND HUM

Balanced XLR or TRS cables are better for long runs. Hum can be a problem when connecting to TV-cable rigs, since the TV cable often creates a ground conflict. Request or install a TV-cable isolator to reduce this problem.

Hum can also occur earlier in the signal chain, depending on the types of connections. It often helps to plug everything into the same AC strip, if the total power consumption is not excessive.

As a last resort, mild hum can sometimes be reduced by lowering the amp gain, and increasing the source gain to compensate, but you must ensure that the source can deliver the extra volume without overload distortion. If this does not reduce hum, it is coming from the source.

### AMPLIFIER NEEDS SERVICING

The following conditions indicate possible unsafe conditions that require service before using. If observed, unplug the AC cord from the wall and when safe, remove the amp for servicing.

- If the amplifier emits smoke or burning smells
- If the case is severely dented or deformed
- If the amplifier is soaked with any fluid
- If internal parts sound loose
- If the AC breaker trips when power is applied
- If the amplifier is dropped, carefully inspect for damage or loose parts before attempting to use.

# SPECIFICATIONS

	<b>GX3</b>	<b>GX5</b>
<b>SPECIFICATION SUBJECT TO CHANGE WITHOUT NOTICE.</b>		
<b>OUTPUT POWER, 1 kHz, 0.1 % clipping</b>		
8Ω, both channels driven	300 W	500 W
8Ω, single channel driven	350 W	600 W
4Ω, both channels driven	425 W	700 W
4Ω, single channel driven	500 W	850 W
2Ω, both channels driven, 1% clipping	200 W	350 W
SIGNAL TO NOISE (20 Hz – 20 kHz)	100 dB	
INPUT SENSITIVITY	1.2 Vrms	
VOLTAGE GAIN AT 8Ω	32.2 dB	34.4 dB
OUTPUT CIRCUITRY	Class B	2-tier Class H
POWER REQUIREMENTS (1/8 power, pink noise at 4Ω 120 V AC)	6.3 A	6 A
DISTORTION (1 dB below rated power, 20 – 20 kHz)	8Ω, less than 0.05% 4Ω, less than 0.1%	
FREQUENCY RESPONSE	20 – 20kHz, +0, -1dB	
DYNAMIC HEADROOM, 4Ω	2dB	
DAMPING FACTOR	100	
INPUT IMPEDANCE	Greater than 20K ohms (balanced or unbalanced)	
MAXIMUM INPUT LEVEL	+24 dB (16 Vrms)	
INPUT CONNECTORS, each channel	3-pin XLR and 1/4" TRS, balanced, parallel Phono, unbalanced	
OUTPUT CONNECTORS, each channel	Speakon®, 1/4", Binding Posts	
AMPLIFIER AND LOAD PROTECTION	Short circuit, open circuit, thermal, RF protection Load protected against DC faults	
CONTROLS AND INDICATORS, FRONT PANEL	Gain controls, 21 detents Red Clip LEDs, proportional, 0.1% THD threshold. Green Signal LEDs, threshold -35 dB Blue Power LED, AC-on.	
CONTROLS, REAR PANEL	Full Range / Crossover switch 100 Hz, 3rd order LP (sub), 2nd order HP (top).	
DIMENSIONS (HWD)	3.5" (2RU) x 19" x 10.1" (89 mm x 483 mm x 257 mm)	
WEIGHT – Shipping / Net	30 / 25 lbs (13.5 / 11.5 kg)	31 / 26 lbs (14 / 12 kg)
AGENCY APPROVALS	UL, CE, RoHS / WEEE compliant	

## AC POWER CONSUMPTION 1/8 power, ohms (AC Current and Heating, 120Vac)

Operating Condition	<b>GX3</b>		<b>GX5</b>	
	AC amps	BTU / hr	AC amps	BTU / hr
Idle	0.2	44	0.3	60
8 + 8 ohms, 1/8 power (1)	4.1	904	3.3	734
8 + 8 ohms, 1/3 power (2)	6.1	1160	8.5	1456
8 + 8 ohms, full power (3)	9.75	1109	16.2	1891
4 + 4 ohms, 1/8 power (1)	6.3	1515	5.8	1160
4 + 4 ohms, 1/3 power (2)	9.4	2105	11.2	2162
4 + 4 ohms, full power (3)	15.0	2297	24.5	3754

(1) 1/8 power represents typical operating conditions.

(2) 1/3 power represents peak program levels.

(3) Full power is breaker limited to short periods.

(4) For 230V, multiply AC current by 0.5. For 100V, multiply AC current by 1.25.

# WARRANTY

---

(USA only; other countries, see your dealer or distributor)

## Disclaimer

QSC Audio Products, Inc. is not liable for any damage to amplifiers or any other equipment that is caused by negligence or improper installation and/or use of this loudspeaker product.

## QSC Audio Products 3 Year Limited Warranty

QSC Audio Products, Inc. ( QSC ) guarantees its products to be free from defective material and / or workmanship for a period of three (3) years from date of sale, and will replace defective parts and repair malfunctioning products under this warranty when the defect occurs under normal installation and use - provided the unit is returned to our factory or one of our authorized service stations via prepaid transportation with a copy of proof of purchase (i.e., sales receipt). This warranty provides that the examination of the return product must indicate, in our judgment, a manufacturing defect. This warranty does not extend to any product which has been subjected to misuse, neglect, accident, improper installation, or where the date code has been removed or defaced. QSC shall not be liable for incidental and/or consequential damages. This warranty gives you specific legal rights. This limited warranty is freely transferable during the term of the warranty period. Customer may have additional rights, which vary from state to state.

In the event that this product was manufactured for export and sale outside of the United States or its territories, then this limited warranty shall not apply. Removal of the serial number on this product, or purchase of this product from an unauthorized dealer, will void this limited warranty. Periodically, this warranty is updated. To obtain the most recent version of QSC's warranty statement, please visit [www.qscaudio.com](http://www.qscaudio.com). Contact us at 800-854-4079 or visit our website at [www.qscaudio.com](http://www.qscaudio.com).

## How to Contact QSC Audio Products

### Mailing address:

QSC Audio Products, Inc.  
1675 MacArthur Boulevard  
Costa Mesa, CA 92626-1468 USA

### Telephone Numbers:

Main Number (714) 754-6175  
Sales & Marketing (714) 957-7100 or toll free (USA only) (800) 854-4079  
Customer Service (714) 957-7150 or toll free (USA only) (800) 772-2834

### Facsimile Numbers:

Sales & Marketing FAX (714) 754-6174  
Customer Service FAX (714) 754-6173

### World Wide Web:

[www.qscaudio.com](http://www.qscaudio.com)

E-mail: [info@qscaudio.com](mailto:info@qscaudio.com)  
[service@qscaudio.com](mailto:service@qscaudio.com)



QSC Audio Products, Inc. 1675 MacArthur Boulevard Costa Mesa, California 92626 USA  
©2007 "QSC" and the QSC logo are registered with the U.S. Patent and Trademark Office.

## Free Manuals Download Website

<http://myh66.com>

<http://usermanuals.us>

<http://www.somanuals.com>

<http://www.4manuals.cc>

<http://www.manual-lib.com>

<http://www.404manual.com>

<http://www.luxmanual.com>

<http://aubethermostatmanual.com>

Golf course search by state

<http://golfingnear.com>

Email search by domain

<http://emailbydomain.com>

Auto manuals search

<http://auto.somanuals.com>

TV manuals search

<http://tv.somanuals.com>