

**IEEE-488/PARALLEL
CONVERTER
IC-488P
User's Manual**

**© COPYRIGHT 1989 ATEN INTERNATIONAL CO., LTD.
Manual part NO. PAPE-0048-100**

USER'S MANUAL

Table of Contents

1. General Description of Functions	1
1-1 Introduction	
1-2 Specifications	
1-3 External view	
2. Installation Procedure	4
2-1 Connecting Cables	
2-2 Dip Switch Default Table	
2-3 Dip Switch Setting Table	
3. Operating Procedure6
3-1 Power On Mode	
3-2 Ready Mode	
3-3 Selecting Address	
4. Troubleshooting	7
5. IC-488P pinning assignment	8
5-1 Input port GPIB Interface	
5-2 Output port Centronics Interface	
6. Appendix A	9
7. Appendix B	10

1. General Description of Functions

1-1 Introduction

Since 1970 lots of western instrument manufacturers gradually realized the importance of interface standardization and started to make efforts in fulfilling this task. That resulted IEEE Association in U.S.A managed to draw up an instrumental interface standard in March 1972.

Nowadays, most of instrument and semi-conductor makers adopt GPIB (General Purpose Interface Bus) as the standard interface of their instruments that is IEEE-488 interface.

In the high technologized society you are surrounded by various electronic devices. Whenever you repair or test these devices, more or less, you will find it is a tough and waste-time task to take records of the results for the afterward reference. In order to resolve this problem We developed the interface converter IC-488P, it provides the data in your instrumental equipment can directly goes through GPIB interface which built in IC-488P and easily get the printed materials you need.

1-2 Specifications

Product Specification Table of IC-488P.

ITEMS	SPECIFICATIONS
Power Supply	DC 9V 200mA
Power Comsumption	MAX. 0.5 WATT
Size	86.4 X 55 X 22.4 mm
Weight	140 g
Enclosure	Metal
Operation Temp.	5°C ↔ 40°C
Storage Temp.	-20°C ↔ 60°C
Data Interface	IEEE-488 → CENTRONICS
Humidity	0%↔80% NON-CONDENSING
IEEE-488 Interface Function	SH0,AH1,L1,T0,SR0,RL0, PP0,DC2,DT0,C0
Input connector	IEEE-488 24 PIN female
Output connector	Centronics 36 PIN male

GENERAL DESCRIPTION OF FUNCTIONS

1-3 External view

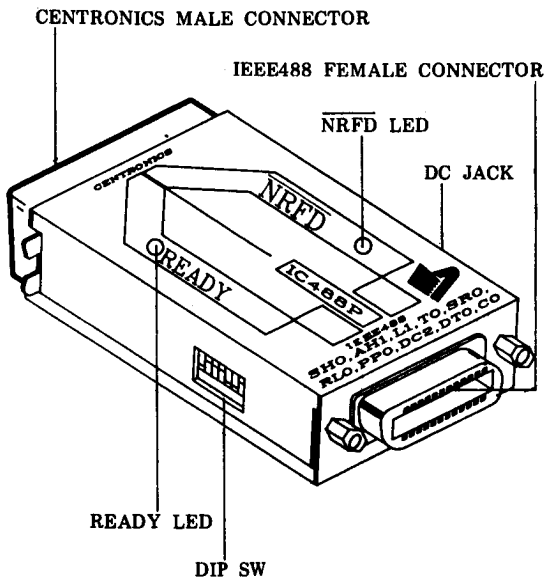

2. Installation Procedure

2-1 Connecting Cables

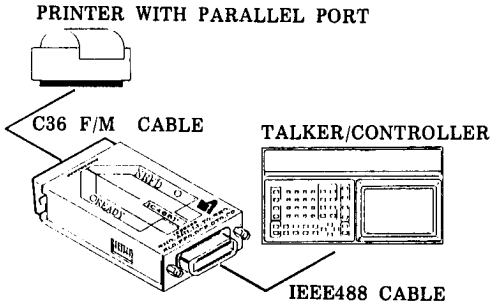

Figure 1

2-2 Dip Switch Default Table

default table

S1	S2	S3	S4	S5	S6
ON	OFF	ON	OFF	ON	OFF

figure 2

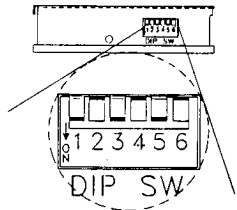

Note: Strictly prevent from putting all dip switches off.

2-3 Dip Switch Setting Table

DEFINITION OF DIP-SWITCH OF IC-488P

DIP-SWITCH							
DESCRIPTION	ASCII	S1	S2	S3	S4	S5	S6
LISTEN ADDRESS 0	SPACE	ON	ON	ON	ON	ON	OFF
LISTEN ADDRESS 1	!	OFF	ON	ON	ON	ON	OFF
LISTEN ADDRESS 2	"	ON	OFF	ON	ON	ON	OFF
LISTEN ADDRESS 3	#	OFF	OFF	ON	ON	ON	OFF
LISTEN ADDRESS 4	\$	ON	ON	OFF	ON	ON	OFF
LISTEN ADDRESS 5	%	OFF	ON	OFF	ON	ON	OFF
LISTEN ADDRESS 6	&	ON	OFF	OFF	ON	ON	OFF
LISTEN ADDRESS 7	'	OFF	OFF	OFF	ON	ON	OFF
LISTEN ADDRESS 8	(ON	ON	ON	OFF	ON	OFF
LISTEN ADDRESS 9)	OFF	ON	ON	OFF	ON	OFF
LISTEN ADDRESS 10	*	ON	OFF	ON	OFF	ON	OFF
LISTEN ADDRESS 11	+	OFF	OFF	ON	OFF	ON	OFF
LISTEN ADDRESS 12	,	ON	ON	OFF	OFF	ON	OFF
LISTEN ADDRESS 13	-	OFF	ON	OFF	OFF	ON	OFF
LISTEN ADDRESS 14	.	ON	OFF	OFF	OFF	ON	OFF
LISTEN ADDRESS 15	/	OFF	OFF	OFF	OFF	ON	OFF
LISTEN ADDRESS 16	0	ON	ON	ON	ON	OFF	OFF
LISTEN ADDRESS 17	1	OFF	ON	ON	ON	OFF	OFF
LISTEN ADDRESS 18	2	ON	OFF	ON	ON	OFF	OFF
LISTEN ADDRESS 19	3	OFF	OFF	ON	ON	OFF	OFF
LISTEN ADDRESS 20	4	ON	ON	OFF	ON	OFF	OFF
LISTEN ADDRESS 21	5	OFF	ON	OFF	ON	OFF	OFF
LISTEN ADDRESS 22	6	ON	OFF	OFF	ON	OFF	OFF
LISTEN ADDRESS 23	7	OFF	OFF	OFF	ON	OFF	OFF
LISTEN ADDRESS 24	8	ON	ON	ON	OFF	OFF	OFF
LISTEN ADDRESS 25	9	OFF	ON	ON	OFF	OFF	OFF
LISTEN ADDRESS 26	:	ON	OFF	ON	OFF	OFF	OFF
LISTEN ADDRESS 27	;	OFF	OFF	ON	OFF	OFF	OFF
LISTEN ADDRESS 28	<	ON	ON	OFF	OFF	OFF	OFF
LISTEN ADDRESS 29	=	OFF	ON	OFF	OFF	OFF	OFF
LISTEN ADDRESS 30	>	ON	OFF	OFF	OFF	OFF	OFF
NO SUCH FUNCTION		OFF	OFF	OFF	OFF	OFF	OFF
LISTEN ONLY		X	X	X	X	X	ON

3. Operating Procedures

3-1 Power On Mode

Using power adapter to connect power source from power jack on IC-488P. In this mode the LED lights of "READY" & "NRFD" are off.

3-2 Ready Mode

1. Using C36 Pin female to male cable to connecting IC-488P and printer, in the mean time turn the printer power supply on. In this mode if printer is "On Line" then the LED lights of "READY" & "NRFD" are on.
2. If printer is in "OFF LINE" Mode then IC-488P will be back to "Power On Mode".
3. Using GPIB cable to connect IC-488P and Controller or Talker output port.

3-3 Selecting Address

1. User shall choose LISTEN ADDRESS of Controller or Talker.
2. Refer to figure(5) and set dip switch to LISTEN ADDRESS.
3. Afterward, IC-488P can accept the signal from Talker and Controller.

NOTE :

1. Be sure data transmission device is adopts GPIB interface .
2. Be sure data receiver device adopts centronics interface .

4. Troubleshooting

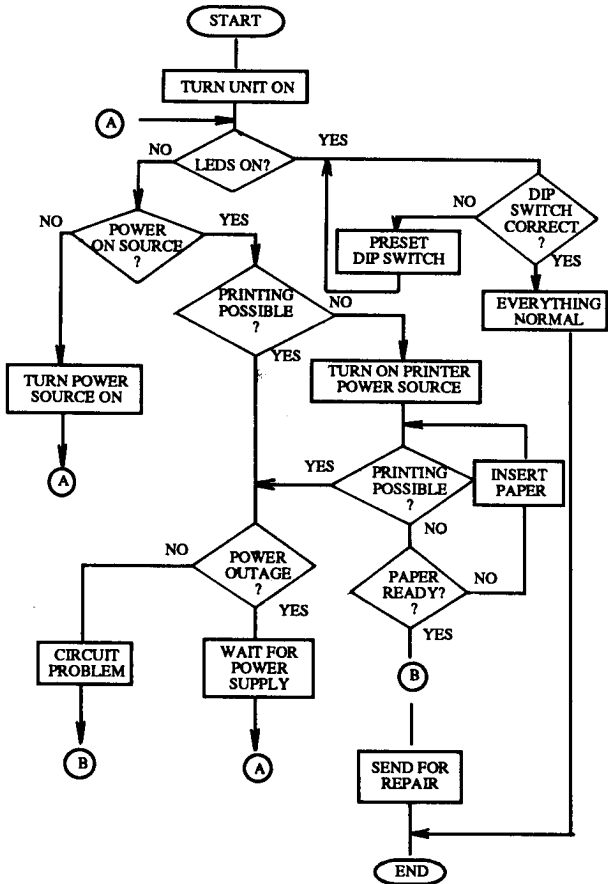

5. IC-488P pinning assignment

5-1 Input port GPIB Interface

Cabling from GPIB to IC-488P.

IEEE-488 Controller GPIB Interface 24 pin Female Connector	24 pin to 24 pin GPIB cable	IC-488P 4 pin Female Connector
1	DIO1	1
2	DIO2	2
3	DIO3	3
4	DIO4	4
5	EOI	5
6	DAV	6
7	NRFD	7
8	NDAC	8
9	IFC	9
10	SRQ	10
11	ATN	11
12	SHIELD	12
13	DIO5	13
14	DIO6	14
15	DIO7	15
16	DIO8	16
17	REN	17
18	GND	18
19	GND	19
20	GND	20
21	GND	21
22	GND	22
23	GND	23
24	LOGIC GND	24

5-2 Output port Centronics Interface

Cabling from IC-488P to Line printer.

IC-488P 36 pin Male Connector	36 pin to 36 pin Female to Male cable or Plug in directly	Line printer 36 pin Female Connector
1	- STROBE	1
2	DATA 0	2
3	DATA 1	3
4	DATA 2	4
5	DATA 3	5
6	DATA 4	6
7	DATA 5	7
8	DATA 6	8
9	DATA 7	9
10	- ACK	10
11	BUSY	11
12	PE	12
13	SLCT	13
14	- AUTO FEED XT	14
15	ERROR	15
16	GND	16
17	GND	17
18	NC	18
19	GND	19
20	GND	20
21	GND	21
22	GND	22
23	GND	23
24	GND	24
25	GND	25
26	GND	26
27	GND	27
28	GND	28
29	GND	29
30	GND	30
31	- INIT	31
32	NC	32
33	GND	33
34	NC	34
35	NC	35
36	SLCT	36

6. Appendix A

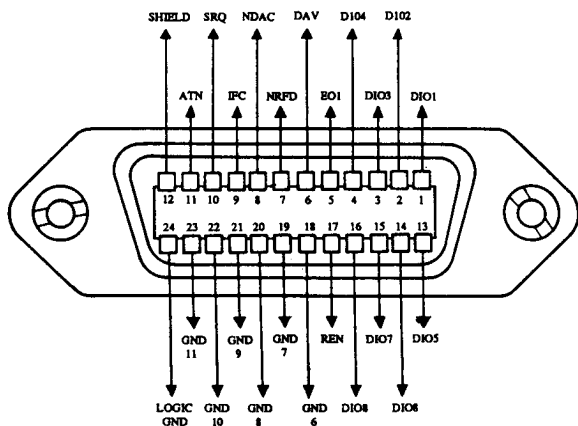

IEEE-488 Connector Pinning Assignment

7. Appendix B

(1) BINARY BITS D3 D2 D1 D0 B4 B3 B2 B1	0 0 0		0 0 1		0 1 0		0 1 1		1 0 0		1 0 1		1 1 0		1 1 1	
	ASCII / ISO															
	CONTROL				NUMBERS/ SYMBOLS				UPPER CASE				LOWER CASE			
0 0 0 0	00	16	32	48	64	80	96	112	NUL	DLE	SP	@	P	\	P	
0 0 0 1	01	17	33	49	65	81	97	113	SOH	DC1/XON	!	A	Q	A	Q	
0 0 1 0	02	18	34	50	66	82	98	114	STX	DC2	"	B	R	B	R	
0 0 1 1	03	19	35	51	67	83	99	115	ETX	DC3/XOF	#	C	S	C	S	
0 1 0 0	04	20	36	52	68	84	100	116	EOT	DC4	\$	D	T	D	T	
0 1 0 1	05	21	37	53	69	85	101	117	ENQ	PPU	%	E	U	E	U	
0 1 1 0	06	22	38	54	70	86	102	118	ACK	SYN	&	F	V	F	V	
0 1 1 1	07	23	39	55	71	87	103	119	BEL	ETB	'	G	W	G	W	
1 0 0 0	08	24	40	56	72	88	104	120	BS	SPE	(H	X	H	X	
1 0 0 1	09	25	41	57	73	89	105	121	HT	SPD)	I	Y	I	Y	
1 0 1 0	10	26	42	58	74	90	106	122	NL/LF	SUB	*	J	Z	J	Z	
1 0 1 1	11	27	43	59	75	91	107	123	VT	ESC	+	K	[K	{	
1 1 0 0	12	28	44	60	76	92	108	124	FF	FS	,	L	\	L	;	
1 1 0 1	13	29	45	61	77	93	109	125	CR	GS	-	M]	M	}	
1 1 1 0	14	30	46	62	78	94	110	126	SO	RS	.	N	^	N	~	
1 1 1 1	15	31	47	63	79	95	111	127	SI	US	/	O	_	O	DEL	
									ADDRESSED COMMANDS	UNIVERSAL COMMANDS	LISTEN ADDRESSES	TALK ADDRESSES	SECONDARY ADDRESSES OR COMMANDS			

(1) D0-D6 ARE THE USUAL BINARY BITS.
B1-B7 ARE THE IEEE DATA BITS.

DECIMAL 64 @ IEEE-488 MESSAGE MNEMONIC
HEXADECIMAL 40 ASCII/ISO CHARACTER

ERROR CORRECTION

1. In page 3, sec. 1-3, the figure should be corrected as below:

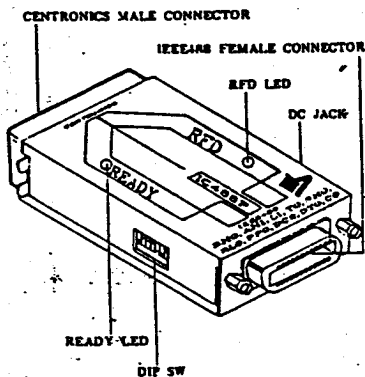

2. In page 4, sec. 2-1, the figure 1 should be corrected as below:

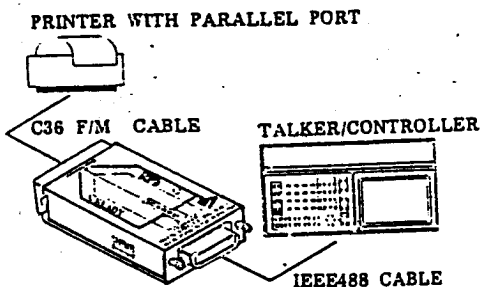

3. In page 6, sec. 3-1, 3-2, all the "NRFD" words should be corrected as "RFD".

Free Manuals Download Website

<http://myh66.com>

<http://usermanuals.us>

<http://www.somanuals.com>

<http://www.4manuals.cc>

<http://www.manual-lib.com>

<http://www.404manual.com>

<http://www.luxmanual.com>

<http://aubethermostatmanual.com>

Golf course search by state

<http://golfingnear.com>

Email search by domain

<http://emailbydomain.com>

Auto manuals search

<http://auto.somanuals.com>

TV manuals search

<http://tv.somanuals.com>