

Quasar®

VHS

VideoViewer

OWNER'S MANUAL

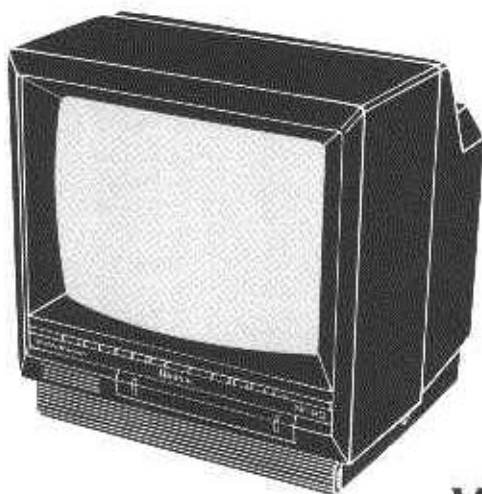

VV8213/VV8213A
MONITOR-VCR

IMPORTANT

Please read owner's manual before attempting to operate.

BASIC CONNECTIONS

Taking the steps shown on this page will prepare your MONITOR-VCR, so you can watch TV and record a TV program. The following connections are one time system setup steps.

(A) BASIC ANTENNA CONNECTIONS

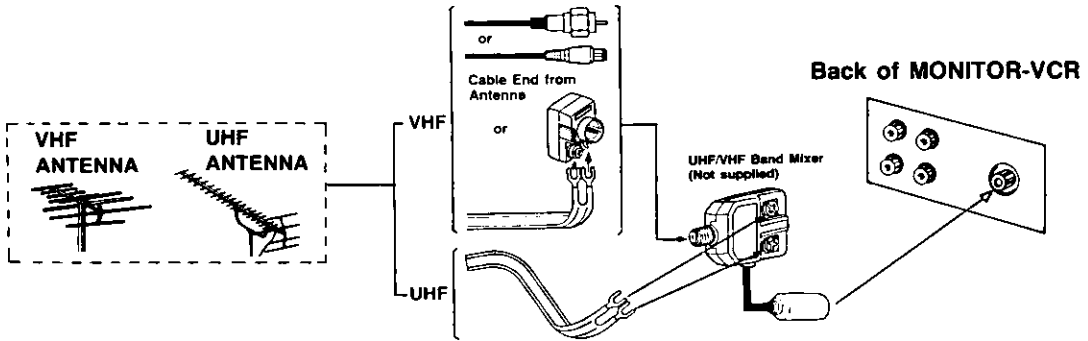

Indoor Antenna Connections

ANTENNA (SUPPLIED)

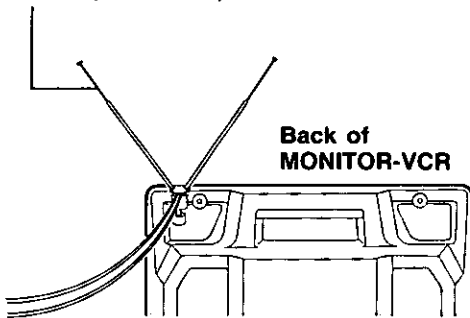

• How to Install Antenna

A rod antenna is packed with your set. Push the stem of the antenna into the antenna hole on the back of the set and connect its wires to the 300 ohm-75 ohm transformer then connect the transformer to the back of the MONITOR-VCR as shown above. Extend the antenna and adjust its length, direction and angle for the clearest picture.

(B) CATV CONNECTIONS WITHOUT A CONVERTER/DESCRAMBLER BOX

Use this connection if your cable system connects directly to your MONITOR-VCR without a converter box.

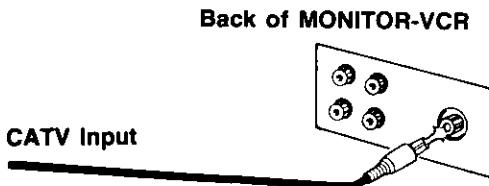

- With this connection you will have:
- Remote Control of all receivable channels.
 - Full programmability of unscrambled channels for unattended recording.

NOTE:

- Use the CHANNEL UP/DOWN Keys to select the desired channel.
- You cannot record or view scrambled channels with this connection.

WITH A CONVERTER/DESCRAMBLER BOX

If your cable service supplies you with a converter box, you can use the basic connection shown here.

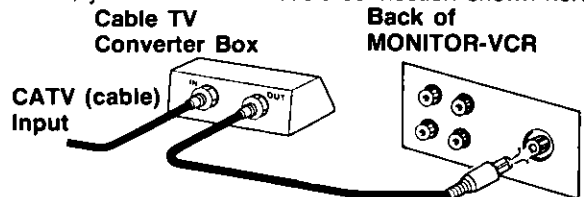

With this connection, you can record and view any channel including scrambled channels.

However, channel selection must be made at the cable company converter box. Therefore, the MONITOR-VCR's remote channel control feature cannot be used, unattended recording is limited to one channel at a time, and you cannot view another channel other than the one you are recording.

TO RECORD AND VIEW A SCRAMBLED/ UNSCRAMBLED CHANNEL

- Set channel selector to the output channel of the Cable Converter Box (e.g. CH 3).
- Select your desired channel on cable converter channel selector.

TABLE OF CONTENTS

INTRODUCTION

We are pleased to introduce to you one of the most sophisticated viewing and entertainment products available today.

This manual is arranged to get you started easily so you can begin to enjoy the world of video as soon as possible. On the facing page you will find the basic steps for setting up your MONITOR-VCR to view TV programs and to record. Keep this manual handy to serve as a quick guide to the video features on your new MONITOR-VCR.

FEATURES

- HQ (High Quality) System
- Quartz Tuner
With Auto Set Feature
- On Screen Display
Programming
- Special Effects Playback
 - Fast Search
 - Double Speed Playback
 - Still Picture
 - Variable Speed Slow Motion
- One Touch Recording
- Unattended (Timer) Recording
- Auto Operation Functions
- Auto Play with Repeat Function
- Wireless Remote Control

TABLE OF CONTENTS



BASIC CONNECTIONS	1
TABLE OF CONTENTS	2
DESCRIPTION OF CONTROLS	3
CLOCK ADJUSTMENT	6
CHANNEL MEMORY	7
TO WATCH TV	9
TO PLAYBACK	11
TO RECORD	13
ONE TOUCH RECORDING	15
TIMER RECORDING	17
HELPFUL HINTS	20
BEFORE REQUESTING SERVICE	23
WARRANTY	25
ACCESSORIES	Back Cover
SPECIFICATIONS	Back Cover

WARNING:

TO PREVENT FIRE OR SHOCK HAZARD, DO NOT EXPOSE THIS EQUIPMENT TO RAIN OR MOISTURE.

This video recorder is equipped with the HQ System, which is compatible with existing VHS equipment.

Only use those tapes with the **VHS** mark. It is recommended that only cassette tapes that have been tested and inspected for use in 2, 4, 6, and 8 hour VCR machines be used.

 CAUTION RISK OF ELECTRIC SHOCK DO NOT OPEN		This symbol warns the user that uninsulated voltage within the unit may have sufficient magnitude to cause electric shock. Therefore, it is dangerous to make any kind of contact with any inside part of this unit.
CAUTION: TO REDUCE THE RISK OF ELECTRIC SHOCK, DO NOT REMOVE COVER (OR BACK) NO USER-SERVICEABLE PARTS INSIDE REFER SERVICING TO QUALIFIED SERVICE PERSONNEL		This symbol alerts the user that important literature concerning the operation and maintenance of this unit has been included. Therefore, it should be read carefully in order to avoid any problems.

DESCRIPTION OF CONTROLS

FRONT

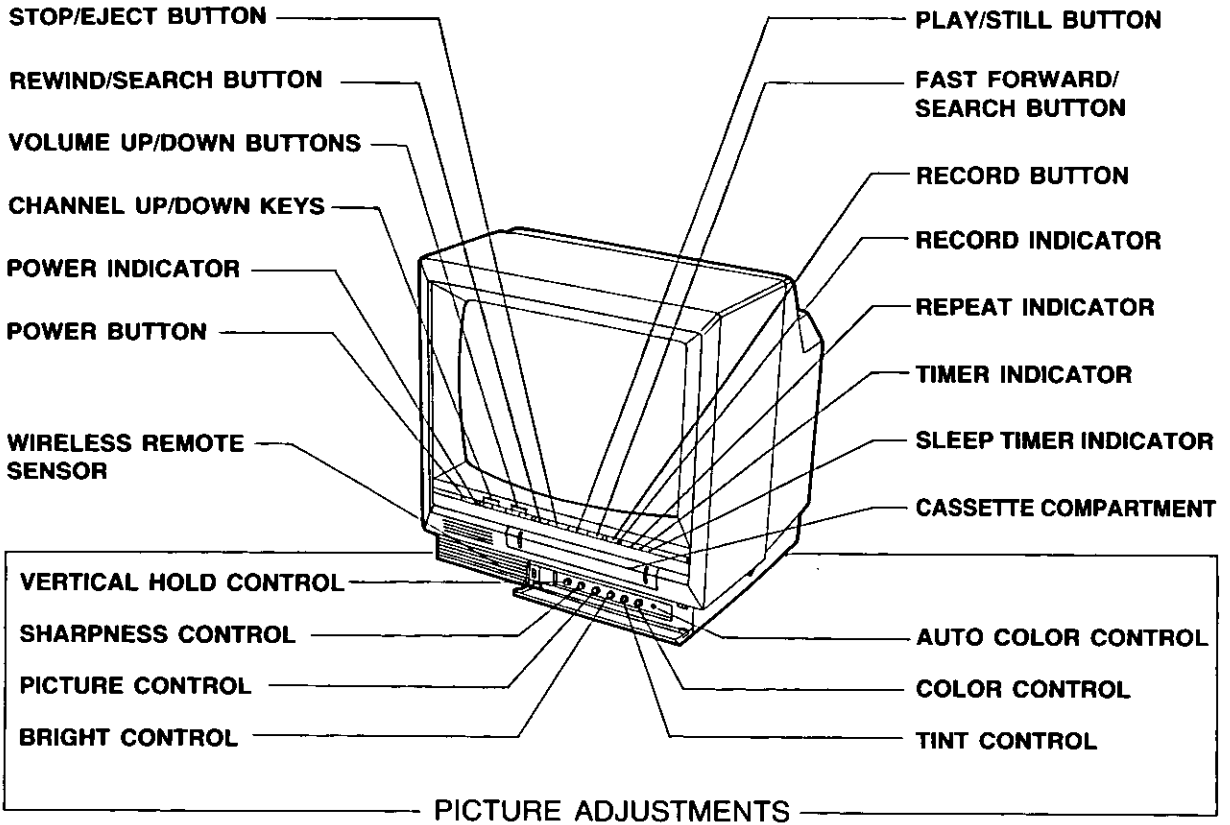

REAR

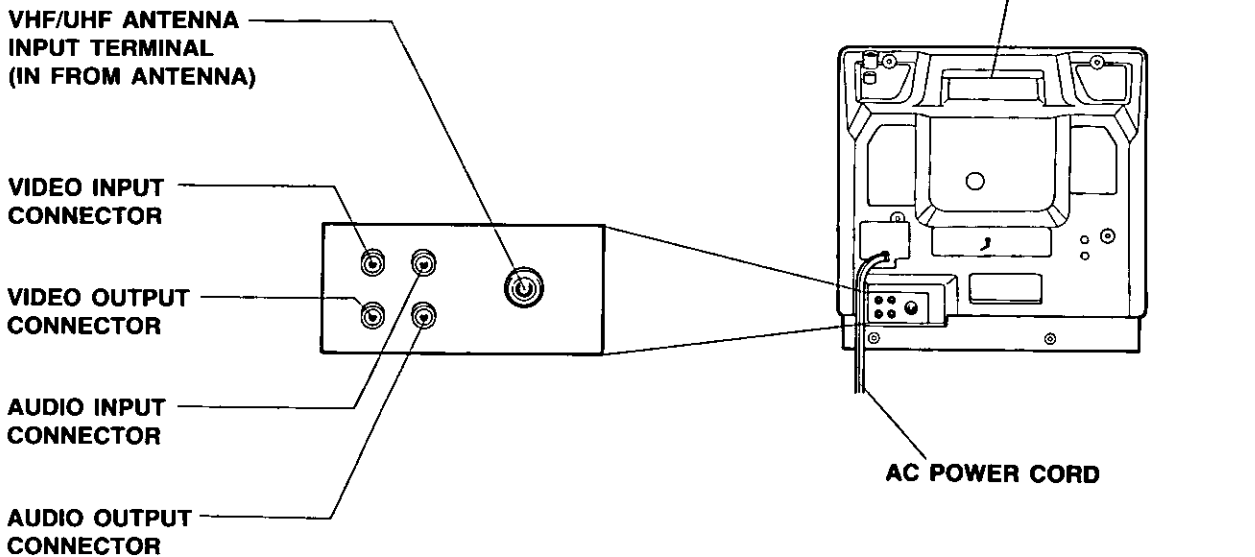

WIRELESS REMOTE CONTROL

Various MONITOR-VCR function controls are conveniently available with your Wireless Remote Control.

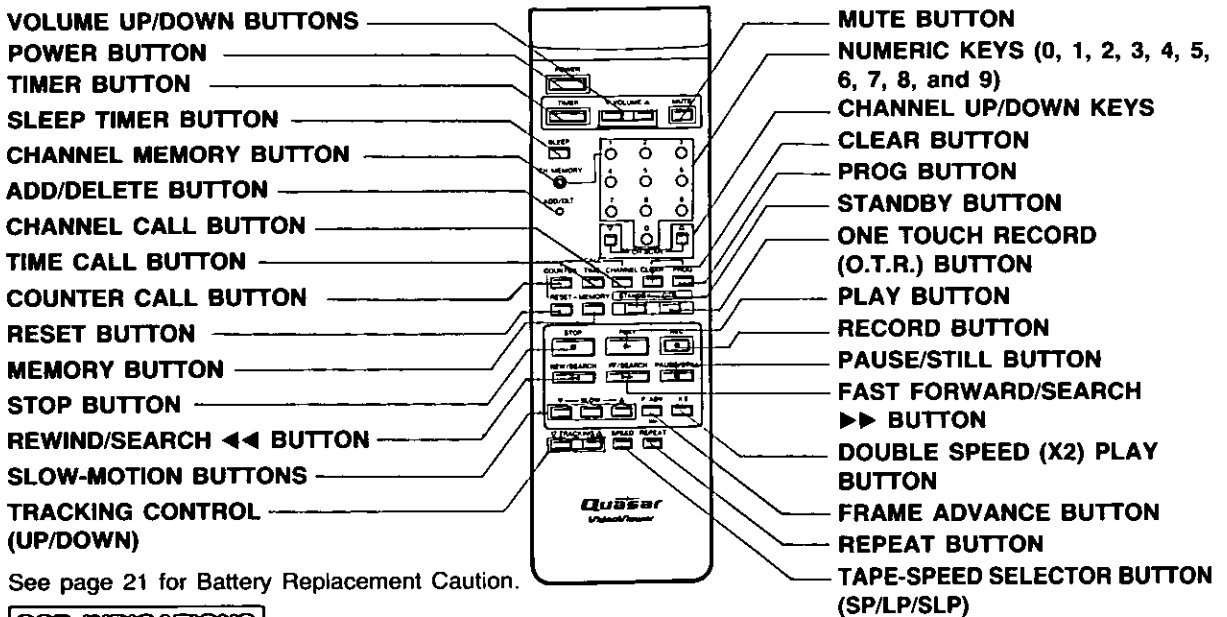

OSD INDICATIONS

The following on-screen graphics will appear automatically for a few seconds when one of the main function buttons is pressed on the remote control or at the MONITOR-VCR. The channel currently tuned-in will be displayed automatically for a few seconds when the power is first turned on, whenever the channel is changed, or when the CHANNEL CALL Button is pressed thereafter.

STOP, EJECT, PLAY, REC, FF, REW, PAUSE, TIME, DATE, CHANNEL INDICATION, TAPE COUNTER/COUNTER MEMORY, TAPE SPEED, STANDBY SET (indicates the Standby O.T.R. mode is set), OTR (whenever Standby OTR starts), DEW*

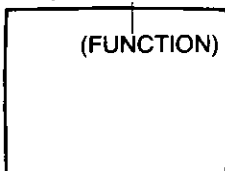

* When "DEW" appears on the TV screen, the unit will not operate due to excessive moisture within it. If this happens, let the MONITOR-VCR remain at room temperature, until this indicator disappears. If there is a cassette in the MONITOR-VCR, it will be ejected when "DEW" appears.

DATE INDICATOR

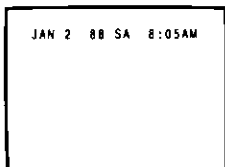

Press the TIME CALL Button to show or remove the date and time from the TV screen.

TAPE COUNTER/COUNTER MEMORY/ TAPE SPEED INDICATOR

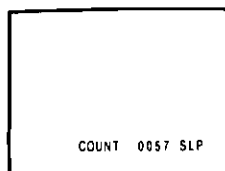

Press the COUNTER CALL Button to show or remove the tape counter/counter memory/tape speed display.

BLANK TAPE INDICATION

If a blank (unrecorded) section of tape is encountered while in the play mode, the TV screen will change to a solid blue field. The screen will remain blue until a recorded signal is again detected.

DESCRIPTION OF CONTROLS (CONTINUED)

FRONT

• **STOP/EJECT BUTTON**

To stop the tape. To remove a cassette in the stop mode.

• **REWIND/SEARCH BUTTON**

To rewind tapes. Also, during playback press this button to do rapid reverse visual search.

• **VOLUME UP/DOWN BUTTONS**

Press either VOLUME UP or DOWN Button to change the sound level.

• **POWER BUTTON**

To turn the MONITOR on and off.

• **VERTICAL HOLD CONTROL**

See page 10 for details.

• **PLAY/STILL BUTTON**

To play back a tape. In SLP playback, press this button once more to view a still picture.

• **FAST FORWARD/SEARCH BUTTON**

To rapidly advance the tape. Also, during playback press this button to do rapid forward visual search.

• **REPEAT INDICATOR**

See page 20 for details.

• **TIMER INDICATOR**

Indicates the MONITOR-VCR is set for unattended recording. Flashes when clock is not set.

• **SLEEP TIMER INDICATOR**

Indicates the MONITOR-VCR is set for SLEEP TIMER.

WIRELESS REMOTE CONTROL

• **VOLUME UP/DOWN BUTTONS**

Same as the VOLUME UP/DOWN Buttons on the MONITOR-VCR.

• **TIMER BUTTON**

To set the MONITOR-VCR for TIMER (unattended) recordings after timer settings have been completed.

• **SLEEP TIMER BUTTON**

Each press of this button advances the automatic off timer by 30 minutes (maximum is 90 minutes).

• **CHANNEL MEMORY BUTTON**

This button is normally OFF. For CHANNEL MEMORY programming, hold this button in and press the NUMERIC Key "1" to use the AUTO SET feature.

• **ADD/DELETE BUTTON**

Used to add or delete a selected channel.

• **CHANNEL CALL BUTTON**

When pressing this button, the number of the channel tuned will be displayed on the TV screen momentarily.

• **TIME CALL BUTTON**

Press the TIME CALL Button to display or clear the date and time from the TV screen.

• **COUNTER CALL BUTTON**

Press this button to display or clear the tape counter/counter memory/tape speed display.

• **REWIND/SEARCH BUTTON**

Same as the REWIND/SEARCH Button on the MONITOR-VCR.

• **SLOW MOTION BUTTONS**

Press the SLOW Button while watching a tape to put action into slow motion for tapes recorded in SLP speed. UP and DOWN Buttons let you adjust slow motion speed from about 1/5 to about 1/30 of normal speed.

• **MUTE BUTTON**

To turn sound off. Press again and sound will return.

• **CLEAR BUTTON**

Press this button to clear the settings for the displayed program contents. While setting the clock or a program, each press of this button moves the digit to the left flashing for correction.

• **PROG BUTTON**

Press this button to display the MENU screen to select either clock adjustment or the timer programming mode.

• **STANDBY BUTTON**

Used along with the O.T.R. Button, to set a delayed (Standby) O.T.R..

• **ONE TOUCH RECORD (O.T.R.) BUTTON**

Select the channel and press the ONE TOUCH RECORD Button to start recording immediately for 30 minutes to 4 hours of recording, or until tape ends. In any case power shut off is automatic.

• **PAUSE/STILL BUTTON**

To temporarily stop the tape during recording or to view a still picture during playback.

• **FAST FORWARD/SEARCH BUTTON**

Same as the FORWARD/SEARCH Button on the MONITOR-VCR.

• **DOUBLE SPEED (X2) PLAY BUTTON**

Press this button during playback of the tapes recorded in SLP mode for rapid tape search at twice the normal speed.

• **FRAME ADVANCE BUTTON**

While viewing an SLP still picture, press this button to advance the picture one frame at a time, or hold it down for a slow motion picture.

• **REPEAT BUTTON**

Used to repeat playback of the whole tape continuously.

• **TAPE SPEED SELECTOR (SP/LP/SLP) BUTTON**

Press to select the desired recording speed.

CLOCK ADJUSTMENT

REMOTE CONTROL

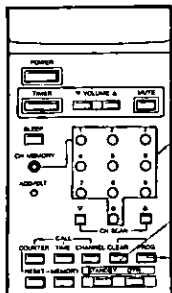

NUMERIC KEYS

CLEAR BUTTON

PROG BUTTON

Accurate clock time is a must for all types of timer recording. Your MONITOR-VCR will accurately maintain its calendar up to "Dec. 31, 2007, 11:59 PM" once you have set the present day and time.

TO SET THE CLOCK

MONITOR-VCR must be ON. Press the "PROG" Button and the clock set guide will appear on the TV screen.

EXAMPLE: To set the clock for FEB 9, 1988, 10:30 AM, enter the following:

MONTH & DAY	YEAR	HOUR & MINUTE	AM/PM	TO START CLOCK
EXAMPLE FEB 9	1988	10 : 30	AM	—
PRESS (NUMERIC KEYS) ①② ③④	⑧⑧	①① ③①	①	PRESS PROG
MONTH DAY	YEAR	HOUR MINUTE	AM	
TV SCREEN DISPLAY				
MONTH 	YEAR 	HOUR 	AM/PM 	
DAY 		MINUTE 		Clock starts. The TV screen will return to the channel selected at the MONITOR-VCR.

- Be sure to enter the first digit to set the month within 30 seconds.
- Be sure to enter "0" before single-digit numbers.

TO MAKE CORRECTIONS IN ON-SCREEN ENTRY

To make corrections after entering a number, press the CLEAR Button to move the flashing indication one space left. Enter the correct number. The flashing indicator will then move one space right.

TO RESET THE CLOCK

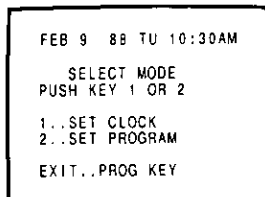

(MENU screen)

If you want to reset the clock at some later time, press the PROG Button while you are watching TV. The MENU screen shown at the left will appear; press key ① and follow the clock set guide to re-enter the new date and time.

- Irregular key entries will be ignored.

CHANNEL MEMORY

Use Channel Memory to limit the CHANNEL UP/DOWN Key channel selection to just those channels active in your area. By following the steps below, you can select "CATV" from the 155 channel memory to receive Cable channels, or select "TV" to receive Broadcast channels. "TV" band channel reception was selected at the factory. You start the AUTO SET cycle to assign just the channels in your area from the band displayed and the MONITOR-VCR returns to normal viewing mode when AUTO SET is complete. Any time a channel is selected for viewing you may drop or assign it for scanning with the ADD/DELETE Button.

REMOTE CONTROL

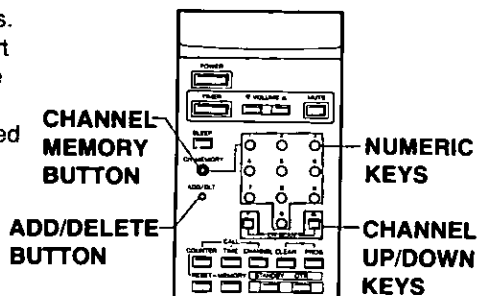

A AUTOMATIC SETTING

SELECT CHANNEL MEMORY	SELECT ANTENNA SYSTEM	
<p>1 Hold the CHANNEL MEMORY Button in and press key 1.</p> <p>CHANNEL MEMORY GUIDE</p> <div style="border: 1px solid black; padding: 5px; margin: 10px 0;"> <p>CH 02(ADD) TV ANTENNA SYSTEM 4...SHIFT TV → CATV 5...NO CHANGE PUSH KEY 4 OR 5 EXIT...CH MEMORY & 1</p> </div> <p>OR</p> <p>→ (4...SHIFT CATV → TV)</p>	<p>2 Press key 4.</p> <p>THE CURRENT BAND CHANGES.</p> <p>from "TV" — to "CATV"</p> <p>or</p> <p>from "CATV" — to "TV"</p> <p>Changing bands removes previous channel assignments and assigns all channels in the new band to the CHANNEL UP/DOWN Keys.</p>	<p>OR 2 Press key 5.</p> <p>THE CURRENT BAND DOES NOT CHANGE.</p> <p>Use when the band selected already matches your Antenna System.</p>
<p>START AUTO SET</p>		
<p>3 Press key 4.</p> <p>AUTO SET GUIDE</p> <div style="display: flex; justify-content: space-around; margin-top: 20px;"> <div style="border: 1px solid black; padding: 5px; width: 45%;"> <p>CH 02(ADD) TV AUTO SET PUSH KEY 4 FOR AUTO SET OR EXIT...CH MEMORY & 1</p> </div> <div style="border: 1px solid black; padding: 5px; width: 45%; text-align: center;"> <p style="font-size: 2em;">02</p> <p>AUTO SET PROCEEDING</p> </div> </div> <p>After key 4 is pressed, the Auto Set Channel Scan starts in the selected band.</p> <p>After Auto Set stops, the lowest numbered channel assigned to the CHANNEL UP/DOWN Keys will appear on screen.</p>		

- Hold the CHANNEL MEMORY Button in and press key **1** for release of CHANNEL MEMORY mode while setting the CHANNEL MEMORY.

B USING THE ADD/DELETE BUTTON

SELECT CHANNEL	DELETE OR ADD THE CHANNEL
<p>1 Select the channel to be deleted or added.</p> <p>The channel can be selected with the CHANNEL UP/DOWN Keys or NUMERIC Keys.</p> <div data-bbox="244 470 524 677" style="border: 1px solid black; text-align: center; width: 200px; height: 100px; margin: 20px auto;">10</div>	<p>2 Press the ADD/DELETE Button.</p> <p>This graphic appears for a few seconds to indicate the channel has been deleted or added.</p> <div data-bbox="847 470 1127 677" style="border: 1px solid black; text-align: center; width: 200px; height: 100px; margin: 20px auto;">CH 10 (DLT) TV or (ADD) CATV</div> <p>A channel "(ADD)" indicates the channel has been assigned.</p> <p>A "(DLT)" indicates the channel is now unassigned to the CHANNEL UP/DOWN Keys.</p>

CHANNEL UP/DOWN KEYS

Any time the CHANNEL MEMORY Button is OFF, you can select assigned channels sequentially using the CHANNEL UP/DOWN Keys. Unassigned channels will be skipped over in sequence.

Note to CATV system installer:

This reminder is provided to call the CATV system installer's attention to Article 820-22 of the NEC in USA (and to the Canadian Electrical code in Canada) that provides guidelines for proper grounding and, in particular, specifies that the cable ground shall be connected to the grounding system of the building, as close to the point of cable entry as practical.

TO WATCH TV

This section describes the operations for watching TV. Use the controls described on the next page to adjust the picture as you desire while you are watching a scene.

TV OPERATION

AT MONITOR-VCR	ADJUST VOLUME	CHOOSE PROGRAM
1 Press the POWER Button.	2 Press the VOLUME UP/DOWN Buttons.	3 Select channel. Use the CHANNEL UP/DOWN or NUMERIC Keys.

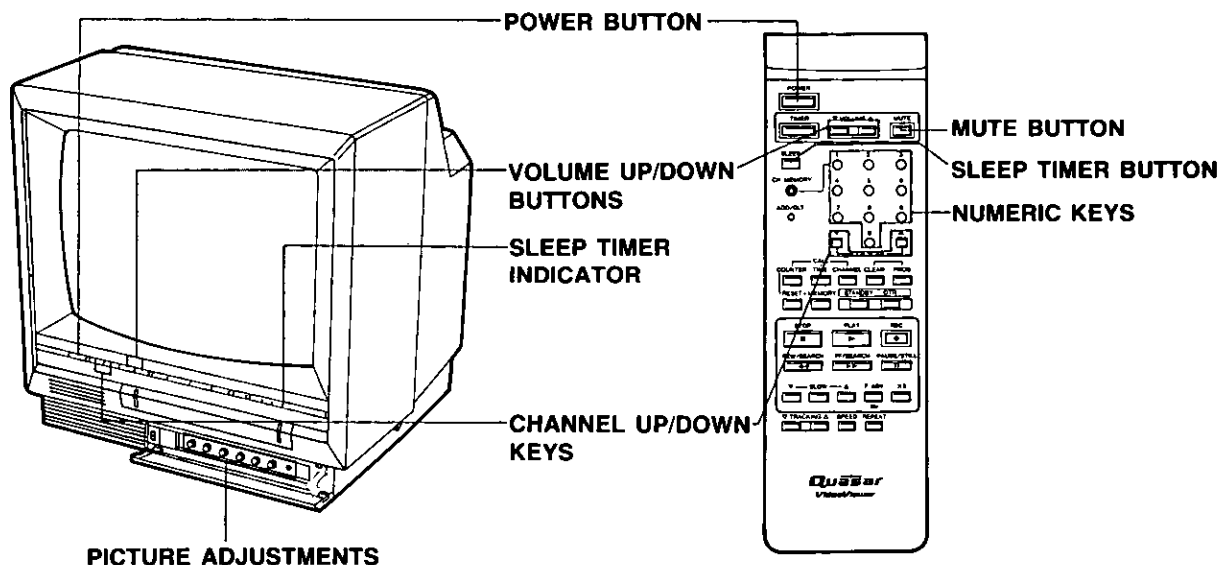

AUDIO MUTE

To mute the sound temporarily, press the **MUTE** Button on the Remote Control. When you press it again, the volume will return to the previous level.

SLEEP TIMER

You can use the **SLEEP TIMER** feature to off automatically at the end of a preset period time (30, 60 or 90 minutes). This feature is useful for watching a late program when you might doze off before the **MONITOR** is turned off.

To set, press the **SLEEP TIMER** Button on the remote control ("30 MIN" will appear in the On Screen Display). Press the **SLEEP TIMER** Button repeatedly until the desired time (60 or 90 minutes) appears in the display.

While the **SLEEP TIMER** is set, the **SLEEP TIMER** Indicator appears on the **MONITOR-VCR**.

The **MONITOR** will turn off automatically after the selected period.

To cancel the **SLEEP TIMER**, press the **SLEEP** Button and select "SLEEP OFF".

Press the **SLEEP TIMER** Button on the remote control.

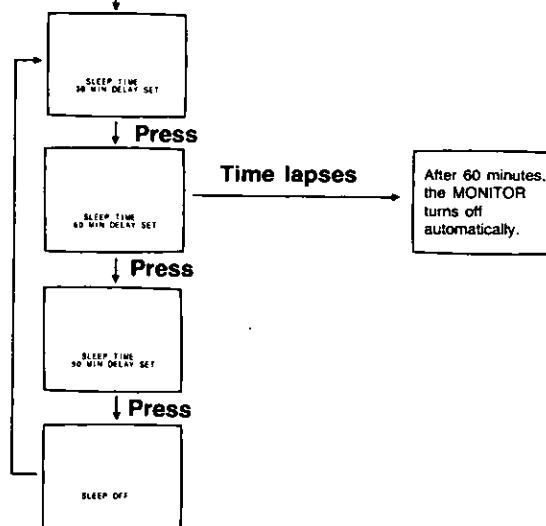

PICTURE ADJUSTMENTS

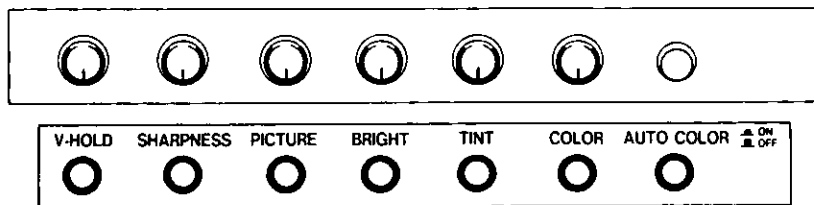

AUTO COLOR CONTROL

When the AUTO COLOR Button is pressed to ON position, tint and color are automatically adjusted. In this position, you may still adjust PICTURE, BRIGHT, TINT and COLOR Controls to vary the levels within the optimum viewing range.

SHARPNESS CONTROL

This control lets you adjust the sharpness of the picture. The recommended setting is in the middle (or detent) position.

PICTURE CONTROL

This control lets you adjust the intensity of the picture. It does this by adjusting contrast and color level at the same time and in the proper balance.

BRIGHT CONTROL

This control lets you adjust the brightness of the picture. The recommended setting is in the middle (or detent) position.

TINT CONTROL

This control lets you adjust for most natural fleshtones.

COLOR CONTROL

This control lets you adjust the intensity of the colors.

VERTICAL HOLD CONTROL



If the picture begins to roll, adjust the Vertical Hold Control to stabilize the picture.

TO PLAYBACK

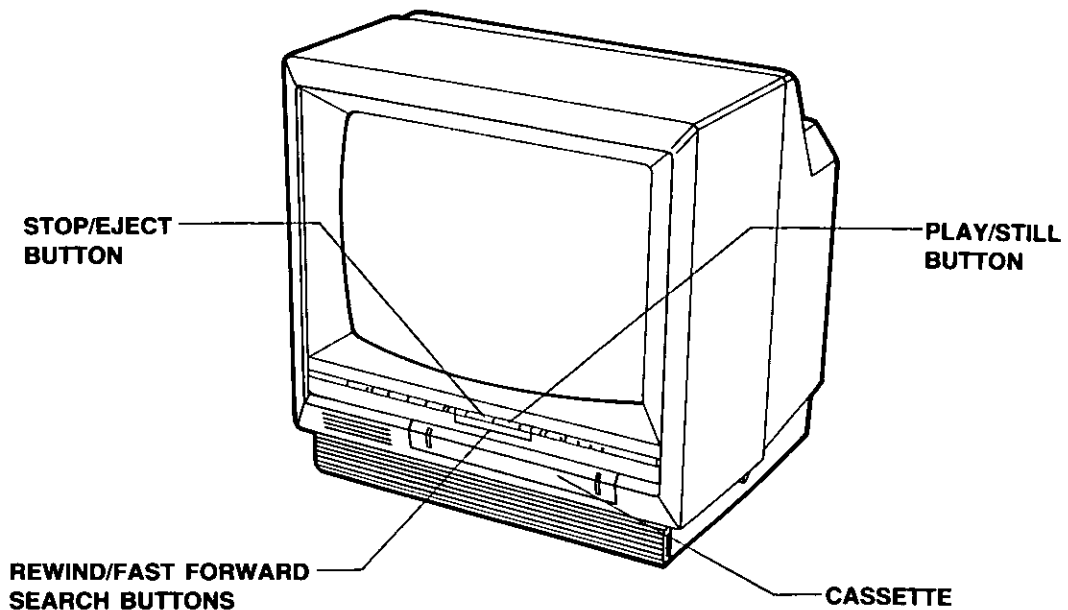
AT MONITOR-VCR	START PLAYBACK	STOP PLAYBACK
<p>1 Insert the cassette.</p> <p>The power will come on automatically.</p> <p>When the record tab is missing, the cassette will be played back automatically. (In this case, skip Step 2.)</p> <p>If a cassette is already in the MONITOR-VCR, just press the POWER Button ON.</p>	<p>2 Press the PLAY Button.</p> <p>The playback starts.</p>	<p>3 Press the STOP Button.</p> <p>This stops the playback completely.</p>

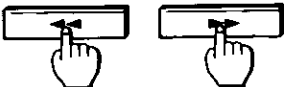

SPECIAL EFFECTS IN PLAYBACK MODE (BEST IN SLP SPEED: SOUND IS MUTED)

TO RAPIDLY LOCATE A PARTICULAR SEGMENT	TO VIEW A DOUBLE SPEED PLAYBACK PICTURE	TO VIEW AN INSTANT SEARCH
<ul style="list-style-type: none"> ■ Press the SEARCH Button. <p>This starts a rapid forward or reverse visual search.</p>  <ul style="list-style-type: none"> ■ Press the SEARCH Button again or the PLAY Button to return to playback. <p>SEARCH SPEED: SLP Search is about 21 times normal speed.</p>	<ul style="list-style-type: none"> ■ Press the X2 Button on the Remote Control. <p>This starts a Double Speed Playback.</p>  <ul style="list-style-type: none"> ■ Press the button once more. <p>This releases the double speed playback and the playback continues.</p>	<ul style="list-style-type: none"> ■ During playback, press the FRAME ADVANCE Button on the Remote Control. This starts rapid forward search for several seconds and the playback continues automatically. 

These automatic features have been designed to simplify **PLAYBACK**.

AUTO OPERATION FUNCTIONS

1. Auto Playback Refer to page 21.
Cassette insertion → (Auto) Power On → Auto Playback (without record tab)
2. Rec Auto Off
Manual Record to Tape end → Rewind → Eject
3. Playback Auto Off
Playback to Tape end → Rewind → Eject → Stop Mode (without record tab)
4. Auto Rewind
Fast Forward to Tape end → Rewind → Stop Mode
5. Eject Cassette
with Power ON or OFF

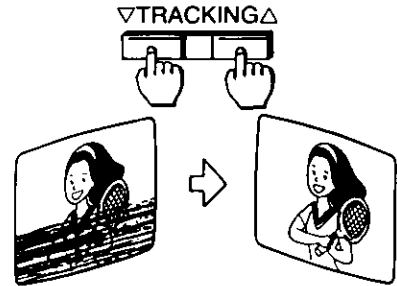

TRACKING CONTROL

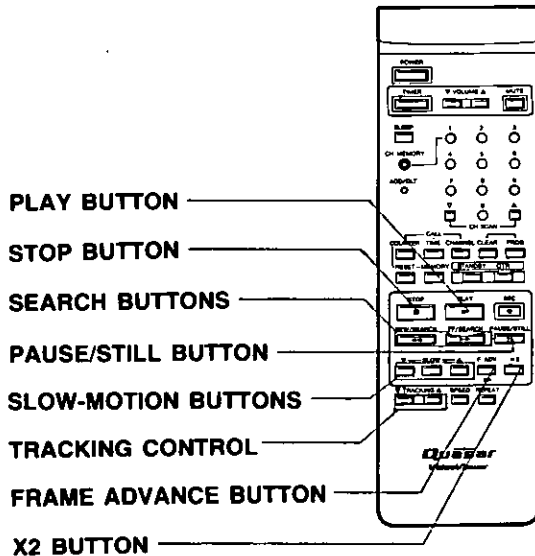

A certain amount of "noise" may appear in the picture when a VHS video tape recorded on one MONITOR-VCR is played back on a different one. You may adjust the TRACKING CONTROL (UP/DOWN) on your Remote Control to minimize this noise in normal playback, double speed playback and slow motion playback. The normal position is automatically set when a cassette tape is inserted.

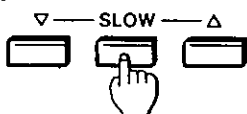

SPECIAL EFFECTS IN PLAYBACK MODE (BEST IN SLP SPEED: SOUND IS MUTED)

TO VIEW A STILL PICTURE	TO ADVANCE A STILL PICTURE	TO VIEW A SLOW PICTURE
<p>■ Press the PLAY/STILL Button (or the PAUSE/STILL Button on the Remote Control). A freeze frame picture of the playback image appears.</p>  <p>■ Press the button once more to release the still . . . the playback continues.</p>	<p>■ During still mode, press the FRAME ADVANCE Button on the Remote Control. Frame advance only operates while viewing a still picture.</p>  <p>• The picture will slowly advance frame by frame when this button is held down.</p>	<p>■ Press the SLOW Button on the Remote Control.</p> <p>You can vary the speed of the slow motion picture by pressing the SLOW UP/DOWN Buttons.</p>  <p>■ Press the PLAY Button to release slow.</p>

To RECORD

AT MONITOR-VCR	SET TAPE SPEED	CHOOSE PROGRAM
<p>1 Insert the cassette with the record tab in place.</p> <p>Power comes on.</p> <p>If a cassette is already in the MONITOR-VCR, press the POWER Button to ON.</p>	<p>2 (a) Press the COUNTER CALL Button.</p> <p>Tape Speed Display appears.</p> <div data-bbox="536 333 817 540" style="border: 1px solid black; padding: 10px; text-align: center;"> <p>COUNT 0057 SLP</p> </div> <p>(b) Press the TAPE SPEED SELECTOR Button.</p> <p>Select SP, LP or SLP. See table at bottom of this page.</p>	<p>3 Select channel.</p> <p>Use the CHANNEL UP/DOWN Keys or NUMERIC Keys.</p>

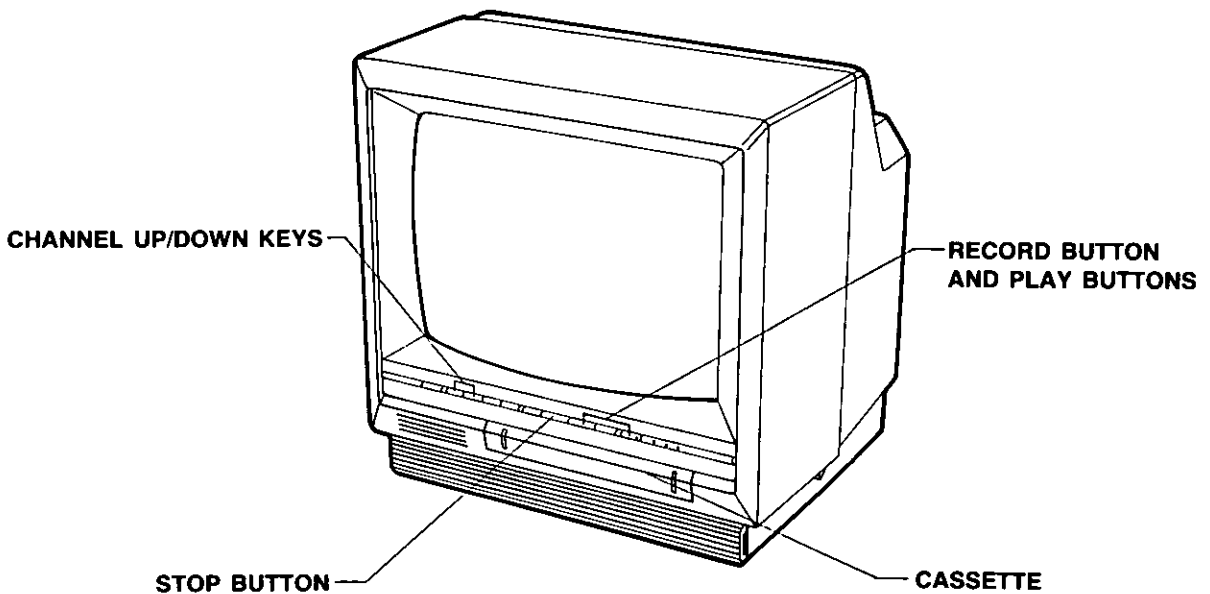

TYPES OF VIDEO CASSETTE

Use types with the **VHS** mark in this unit.

Tape Speed Selector Position	Maximum Record/Playback Time		
	T160	T120	T60
SP (Standard Play)	2 Hours 40 Minutes	2 Hours	1 Hour
LP (Long Play)	5 Hours 20 Minutes	4 Hours	2 Hours
SLP (Super Long Play)	8 Hours	6 Hours	3 Hours

START RECORDING	PAUSE RECORDING	STOP RECORDING
<p>4 Hold the REC Button in and Press the PLAY Button.</p> <p>The recording starts.</p> <p>Using the remote control, press the REC Button to start recording.</p>	<p>5 Press the PAUSE/STILL Button on the Remote Control.</p> <p>The recording stops temporarily.</p> <p>Press this button again to release pause.</p>	<p>6 Press the STOP Button.</p> <p>This stops recording completely.</p>

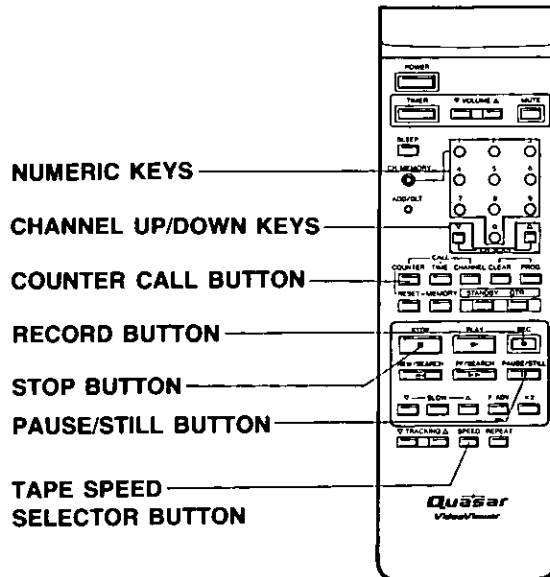

ONE TOUCH RECORDING

A few presses of the OTR Button on the Wireless Remote Control lets you instantly start recording the channel you are watching, or extend a recording-in-progress. The first press of this button allows you to check the OTR status with the On-Screen Display. Quick succeeding presses start a recording and set the length of the OTR.

MAKE SURE THAT...

- the clock is set to the correct time.
- the desired tape speed (SP, LP or SLP) is selected.
- the record tab is not missing on the cassette.
- the tape is long enough to record the programs.

If each succeeding press of the OTR Button does not follow within 5 seconds, the current TV broadcast channel will return to the screen.

A INSTANT O.T.R. — To start recording instantly.

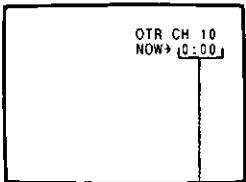
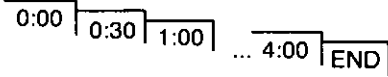
CHOOSE PROGRAM	SELECT O.T.R. DISPLAY	SELECT RECORDING LENGTH
<p>1 Select channel.</p> <p>Use the CHANNEL UP/DOWN Keys or NUMERIC Keys.</p>	<p>2 Press the OTR Button once.</p> <p>This O.T.R. graphic appears.</p> <div style="text-align: center;">  <p>O.T.R. LENGTH DISPLAY</p> </div>	<p>3 Continue to press the OTR Button.</p> <p>Recording begins as you are setting the length.</p> <p>Each press adds 30 minutes of recording time up to 4 hours, or until "END" appears to indicate that your recording will continue up to the end of the tape.</p> <div style="text-align: center;">  </div>

DURING RECORDING

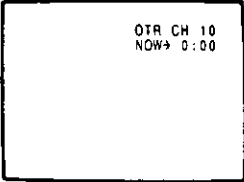
TO CHANGE RECORDING LENGTH	TO STOP OTR
<p>1. Press the OTR Button once. The OTR graphic appears.</p> <p>2. Continue to press the OTR Button.</p> <p>Pressing the OTR Button within 5 seconds for a number of times causes 0:00 to appear and then the new recorded time advances until the desired time is displayed.</p>	<p>1. Press the OTR Button twice. This OTR graphic appears.</p> <div style="text-align: center;">  </div> <p>About 5 seconds later the O.T.R. will stop.</p>

REMOTE CONTROL

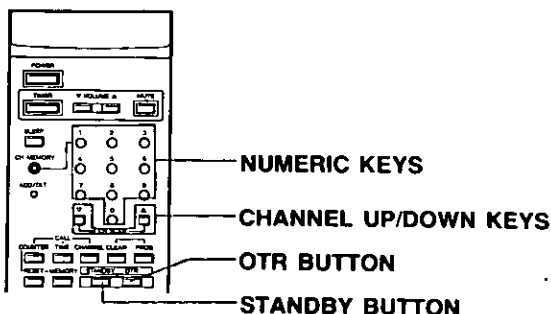

B STANDBY O.T.R. — To delay the start time.

It's often convenient to delay a recording. By pressing the STANDBY Button you can quickly set the MONITOR-VCR to start recording on the hour or half-hour up to 11:30 PM of the following day. Then the length of the recording can be set with the OTR Button. Once you do this, the MONITOR-VCR is on standby, until the recording starts.

CHOOSE PROGRAM	SELECT STANDBY O.T.R.	SELECT START TIME	SELECT O.T.R. LENGTH
<p>1 Select channel.</p> <p>Use the CHANNEL UP/DOWN Keys or NUMERIC Keys.</p>	<p>2 Press the STANDBY Button.</p> <p>This O.T.R. graphic appears.</p> <div style="text-align: center;"> <p>START TIME</p> <p>DATE O.T.R. LENGTH</p> </div>	<p>3 Continue to press the STANDBY Button.</p> <p>This sets the time the recording is to begin.</p> <p>Each press advances the time to the next hour or half-hour, from the current time indicated, up to 11:30 PM of the next day (up to a maximum time of 47.5 hours).</p>	<p>4 Press the OTR Button.</p> <p>Press this button as many times as necessary to set the recording length of the Standby O.T.R..</p>

TO CANCEL STANDBY O.T.R.

To cancel or stop a Standby OTR Program, press the OTR Button twice. The O.T.R. graphic below appears.

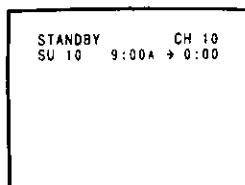

About 5 seconds later the program will be erased.

TIMER RECORDING

Your MONITOR-VCR will begin 4 separate unattended recordings any time within one month of the time you set them. Whenever a program number is vacant you can schedule a recording for some day ahead or even a full series of recordings, with the time and channel you desire. A series recording starts everyday or on the same day of each week, automatically adding recording after recording up to the end of a tape.

MAKE SURE THAT...

- the clock is set to the correct time.
 - the desired tape speed (SP, LP or SLP) is selected.
 - the record tab is not missing on the cassette.
 - the tape is long enough to record the programs.
- If no selections are entered within 30 seconds, the programming screen will return to the menu screen.

Choose the day, time and channel you want for a timer recording then follow the six steps below to enter the program and set the timer.

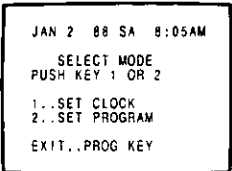
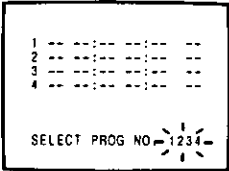
SELECT THE MENU SCREEN AND PROGRAM SET MODE	SELECT THE PROGRAM NUMBER	FOLLOW THE PROGRAM GUIDE ON TV SCREEN
<p>1 Press the PROG Button.</p> <p>2 Press key ②.</p>  <p>(MENU screen)</p>	<p>3 Press key ①.</p>  <p>(PROGRAM screen)</p>	<p>4 Press the NUMERIC Keys.</p> <p>For each prompt enter the information desired with the NUMERIC Keys.</p> <p>See example on the following page.</p>

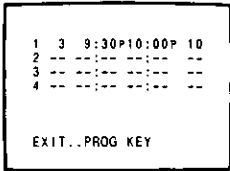
SET NEXT PROGRAM	SET THE TIMER
<p>5 Press key ② or press the PROG Button to return to the broadcast channel.</p> 	<p>6 Press the TIMER Button.</p> <p>This sets the Timer for Timer programming. The TIMER Indicator on the MONITOR-VCR will light. If no cassette is inserted or the record tab is missing, the TIMER Indicator will flash to alert you, and the cassette inserted will be ejected automatically.</p> <hr/> <p>AFTER THE TIMER RECORDING HAS TAKEN PLACE</p> <p>■ Press the TIMER Button to turn the TIMER Button off for normal VCR operation.</p>

REMOTE CONTROL

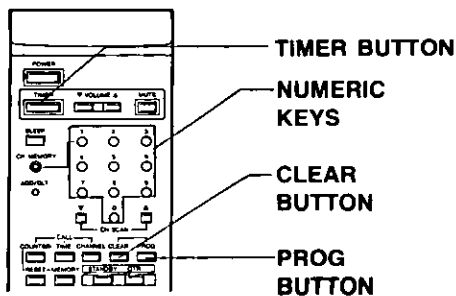

MONITOR-VCR FRONT PANEL

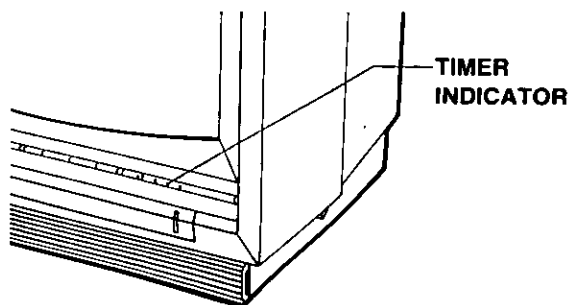

EXAMPLE: To set program 1 to record on the 3rd day on the current month, from 9:30 PM to 10:00 PM on CH10, enter the following:

REC-ON DAY	REC-ON TIME	REC-OFF TIME	REC-ON CHANNEL
EXAMPLE JANUARY 3RD	9:30 PM	10:00 PM	CHANNEL 10
PRESS (NUMERIC KEYS)			
① ③	① ⑨ ③ ① ②	① ① ① ① ②	① ①
DAY OF MONTH	HOUR MINUTE PM	HOUR MINUTE PM	CHANNEL
TV SCREEN DISPLAY			
DAY	TIME ON	TIME OFF	CHANNEL
<pre> P ON → OFF CH 1 JAN 02 SA -- ----->----- SET REC-ON DAY OR SELECT DAILY..4 WEEKLY..5 EXIT..PROG KEY </pre>	<pre> P ON → OFF CH 1 JAN 03 SU -- 09:05A → ----- SET REC-ON TIME EXIT..PROG KEY </pre>	<pre> P ON → OFF CH 1 JAN 03 SU -- 09:30P → 10:30P -- SET REC-OFF TIME EXIT..PROG KEY </pre>	<pre> P ON → OFF CH 1 JAN 03 SU -- 09:30P → 10:00P -- SET REC-ON CHANNEL EXIT..PROG KEY </pre>
	AM/PM	AM/PM	
	<pre> P ON → OFF CH 1 JAN 03 SU -- 09:30A → ----- SET AM/PM AM..1 PM..2 EXIT..PROG KEY </pre>	<pre> P ON → OFF CH 1 JAN 03 SU -- 09:30P → 10:00P -- SET AM/PM AM..1 PM..2 EXIT..PROG KEY </pre>	

TO MAKE CORRECTIONS IN ON-SCREEN ENTRY

To make corrections after entering a number, press the CLEAR Button to move the flashing indication one space to the left. Enter the correct number. The flashing indicator will then move one space to the right.

TIMER RECORDING (CONTINUED)

DAILY RECORDING: To record at the same time each day.

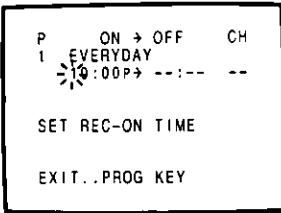

1. Perform steps 1-3 on page 17.
2. After completing step 3 on page 17 the display shown under "DAY" will appear for rec-on day.
3. Enter key **4** to select the Daily Recording mode. The screen shown at the left will appear.
4. Continue with the program guide shown on pages 17 and 18 to complete programming.

WEEKLY RECORDING: To record at the same time on the same day each week.

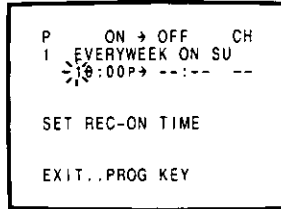
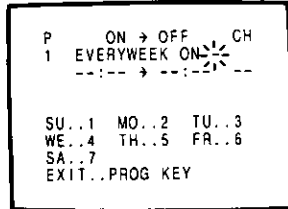

1. Perform steps 1 - 3 on page 17.
2. After completing step 3 on page 17 the display shown under "DAY" will appear for rec-on day.
3. Enter key **5** to select the Weekly Recording mode. The screen shown at far left will appear.
4. Select the rec-on day for each week by number.
5. Continue with the program guide shown on pages 17 and 18 to complete programming.

TO CHECK PROGRAMS

a) When a Timer Recording has been set but is not yet in-progress.
(TIMER Indicator is lit.)

1. Press the TIMER Button to release the Timer Set mode.
 2. Follow steps 1 and 2 on page 17 to check or re-enter the program contents.
- After checking, press the PROG Button twice to return to viewing channels.

b) When a Timer Recording has been set and is now in progress.

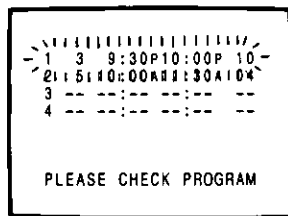

■ Press the PROG Button.

The screen at the left will appear displaying all programs currently set for recording. The program-in-progress will be flashing.

The program being recorded will disappear after about 30 seconds. Or, immediately return to the program being recorded by pressing the PROG Button again.

TO CLEAR PROGRAMS: After programming is complete and Power is still ON.

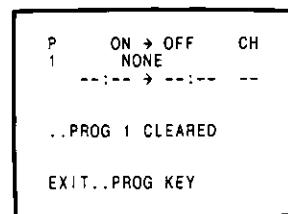

1. Perform steps 1 and 2 on page 17 to display the program.
2. Enter the program number you want to clear.
3. Press the CLEAR Button.

- The screen at the left will appear for a few seconds. Then to enter a new program follow the program guide when the DAY screen appears.

HELPFUL HINTS

A RE-RECORDING (TAPE DUPLICATION)

It is simple to dub tapes using your MONITOR-VCR to record and another VCR for playback.

CAUTION: Unauthorized exchanging and/or copying of copyrighted recordings may be copyright infringement.

CONNECTION

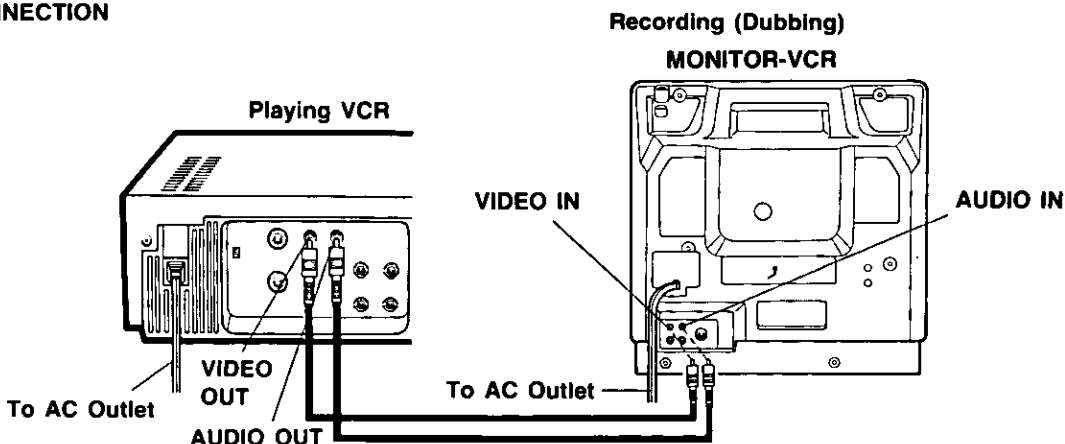

OPERATION

1. Set up your MONITOR-VCR for recording.
2. Set up the other VCR for playback.
3. Press the PLAY Button on the playing VCR.
4. Press the RECORD Button and the PLAY Button together on the recording MONITOR-VCR.

NOTE: • Be sure steps 3 and 4 are done simultaneously to avoid missing any of the recording.

B AUTO PLAY WITH REPEAT FUNCTION

The Auto Repeat function allows you to set the MONITOR-VCR to repeat playback of the whole tape continuously.

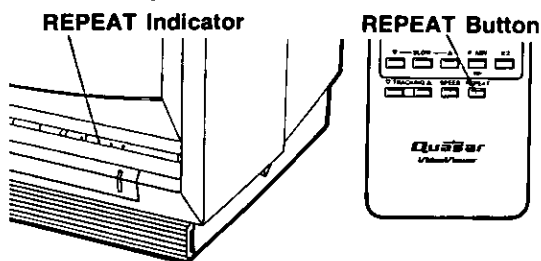

From wherever you press the REPEAT Button, the tape will play back to its end, rewind, and playback again. (Repeat Indicator will light up.) This process will continue automatically until another function button is pressed. Auto Repeat will function in STOP, FF, REW, or PLAY mode.

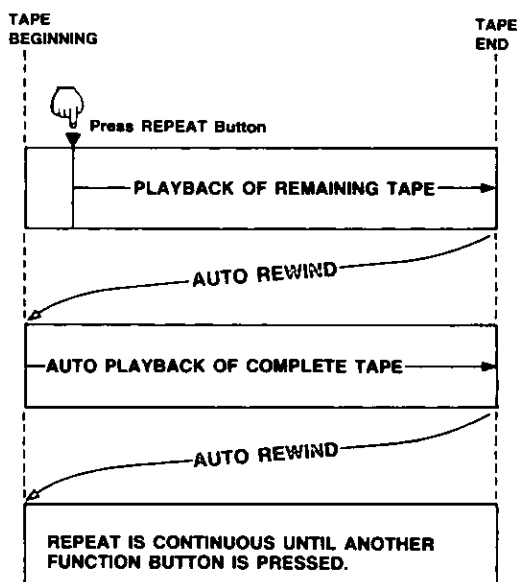

HELPFUL HINTS (CONTINUED)

C TAPE COUNTER CONTROLS

Tape Counter Operation

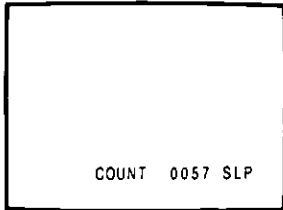

1. Press the COUNTER CALL Button so that the Counter Display appears.
2. Press the REWIND or FAST FORWARD Button to wind the tape to the starting point you select.
3. Press the RESET Button to set the counter to "0000".

Counter Memory Operation

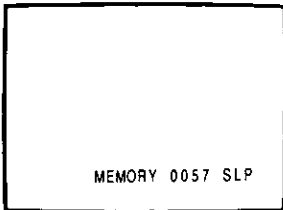

1. Reset the counter to "0000" at whatever point you choose on the tape.
2. Press the MEMORY Button. "MEMORY" appears on the TV screen. During fast forward or rewind the tape will stop automatically wherever "0000" was set.

D WIRELESS REMOTE BATTERY INSTALLATION

LOAD THE BATTERIES AS FOLLOWS:

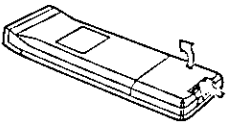
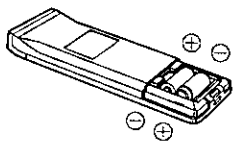
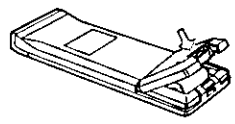
<p>1 Lift off the lid after pressing in and up on the lid latch with your thumb nail or other narrow object.</p> 	<p>2 Install two batteries as indicated inside the Battery Compartment.</p> 	<p>3 Fit the lid's hinge piece into the indent on the case, and snap lid into place.</p> 
---	--	--

BATTERY REPLACEMENT CAUTION

- Do not mix old and new batteries. (Also never mix alkaline batteries with manganese batteries.)

E ERASE PROTECTION

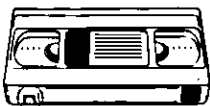

Record Tab

- Accidental erasure of recorded material can be prevented by breaking off the record tab on the rear of the cassette with a screwdriver or similar tool. This will cause the erasure prevention mechanism to function.
- If for any reason, you later want to record on a cassette which has been protected as described above, recordings can be made after covering the hole, where the tab was removed, with cellophane tape.

- To Prevent Accidental Erasure

Break off the tab with a screwdriver

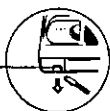

- To Record Again

Cover the hole with cellophane tape

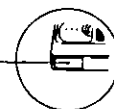

F NOTES ON OPERATIONS

BASIC CONNECTIONS

- With cable connections, numbers selected to receive specific channels may differ from those for antenna connections. Refer to your cable service information.

CLOCK ADJUSTMENT

- Enter the first digit to set the month within 30 seconds of the appearance of the clock set guide. Otherwise, the program you were watching will return to the screen. If this happens, press the PROG Button and start again.
- The letters for day of the week will automatically appear when you have entered both digits for the year.
- If the day digit entered does not match the calendar, it will advance to the first day of the next month (for example, "FEB 29 89" will advance to "MAR 01 89").
- If you press the PROG Button while the clock set guide "-- -- --:--" appears, the TV screen will return to the program you were watching.

TO PLAYBACK

- During search playback, horizontal noise bars will appear on the TV screen.
- After the MONITOR-VCR has been in pause, or still for 5 minutes it will stop automatically for tape and video head protection.
- In search or still playback, some amount of noise may appear for tapes recorded in SLP mode. The picture may be completely snowy in search or still mode for tapes recorded in SP or LP speed.

TO RECORD

- It is possible to change the Tape Speed Selection while you are actually recording but there will be a momentary distortion when the tape is played back over the points where the tape speed change occurred.
- After the MONITOR-VCR has been in pause for 5 minutes it will stop automatically for tape and video head protection.

ONE TOUCH RECORDING

- During a One Touch Recording, press the OTR Button once to see the remaining recording time overlay.
- If the record tab is missing on the cassette, it will be ejected when you press the OTR Button or STANDBY Button.
- If the preset time for a Timer Recording comes up during a One Touch Recording, the One Touch Recording will take priority.

TIMER RECORDING

- Timer recording may not be performed or continued if a power interruption of more than about 60 minutes occurs before or during Timer Recording, even if power resumes thereafter.
- If the start times of 2 preset programs overlap, the preset time of the lower numbered program will have priority.

RE-RECORDING

- For technical reasons, the quality of the dubbed tape will not be as good as the original.

G CLEANING CARE FOR VIDEO HEADS ...



Clogged Video Head

(a) **Video Head Cleaning:** Your MONITOR-VCR will not normally require head cleaning; however, it is possible that the heads may become clogged when playing an old or damaged tape. If the image on your screen resembles the photograph on the left, while playing back a tape, the heads may require cleaning.

(b) **Cleaning the Heads:** It is recommended that head cleaning be performed by a qualified service technician. Please contact your nearest Quasar Servicing Dealer or Matsushita Service Company. An alternate solution is to obtain a head cleaning cassette. There are many types of cleaning cassettes, so be sure to follow the cleaning instructions carefully. Excessive use of the cleaning cassette could shorten head life. Use this cassette only when a head clogging symptom occurs.

BEFORE REQUESTING SERVICE

Check the following points once again.

POWER

Troubles	Corrections
No power ...	<ul style="list-style-type: none">• Check that the Power Plug is completely connected to an AC Outlet.• Check that the POWER Button is set to "ON".
No operation starts when operation buttons are pressed ...	<ul style="list-style-type: none">• Check the DEW Indicator. If it is displayed, the unit will not operate. (p.4)

MONITOR (At first, check antenna – its wires, connections, and direction. Then follow the corrections below.)

Troubles	Corrections
No picture or sound...	<ul style="list-style-type: none">• Check the power plug is completely connected to an AC Outlet.• Check that the POWER Button is set to "ON".
Poor picture with normal sound ...	<ul style="list-style-type: none">• Adjust Bright, Sharpness, and Picture controls. (P.10)
Poor sound with normal picture ...	<ul style="list-style-type: none">• Adjust Volume control. (P.9)
Poor TV reception ...	<ul style="list-style-type: none">• Adjust Sharpness and Picture controls. (P.10)
Picture rolls vertically ...	<ul style="list-style-type: none">• Adjust Vertical Hold control. (P.10)
No color or poor color ...	<ul style="list-style-type: none">• Adjust Tint and Color controls. (P.10)
Ghosts (Multiple images) ...	<ul style="list-style-type: none">• Install a directional antenna.
TV programs can't be watched ...	<ul style="list-style-type: none">• Make sure that the receiving channel of the MONITOR-VCR is memorized. (P.7)• Check that the band selected is set to meet your antenna or cable TV system. (P.7)

VCR

Troubles	Corrections
TV programs can't be recorded ...	<ul style="list-style-type: none">• Make sure that the record tab on the back of the cassette is still intact. (P.21)• Make sure that the Video and Audio-Input Connectors are not connected with cables. (P.20)
Timer Recording can't be performed ...	<ul style="list-style-type: none">• Set the recording start/stop time correctly. (P.17)• Make sure that the TIMER Button is set to "ON". (P.17)• Timer Recording may not be performed or continued if a power interruption of more than 60 minutes occurs before or during Timer Recording, even if power resumes thereafter.
There is no playback picture or the playback picture is noisy or contains streaks ...	<ul style="list-style-type: none">• Adjust the TRACKING CONTROL slowly in either direction. (P.12)

REMOTE CONTROL

Trouble	Corrections
RECORDER cannot be remote controlled ...	<ul style="list-style-type: none">• Aim the Wireless Remote Control directly at the remote sensor on the MONITOR-VCR.• Avoid all obstacles which may interfere with the signal path.• Replace or inspect the batteries. (P.21)

OTHERS

Troubles	Corrections
Video cassette can't be inserted ... Video cassette can't be removed ... If eject does not function or insertion cannot be done ... Video cassette ejects when the OTR, STANDBY, REC and PLAY Buttons are pressed or the TIMER Button is pressed to set the Timer...	<ul style="list-style-type: none">• Insert the cassette with the window side up and the record tab facing you. (P.21)• Check that the Power Plug is completely connected to an AC Outlet.• Try turning the POWER OFF and then ON again, and try ejecting or inserting the tape again.• Check the cassette to be sure that the record tab on the back of the cassette is still intact. (P.21)

Your product is designed and manufactured to ensure a minimum of maintenance. However, should your unit ever require service, a nationwide system of **FACTORY SERVICENTERS** and **AUTHORIZED INDEPENDENT SERVICENTERS** is maintained to support your product's warranty.

**Service in the U.S.A....
Factory Servicers**

MATSUSHITA SERVICES COMPANY
Division of Matsushita Electric Corporation of America
50 Meadowland Parkway Secaucus, New Jersey 07094

ALABAMA

2523-5th Avenue,
South Birmingham,
AL 35233
205-252-4195

ARIZONA

9332 North 95th Way
Suite 101
Scottsdale, AZ 85258
602-860-6777

CALIFORNIA

6550 Katella Avenue
Cypress, CA 90630
714-373-7426

930 South Mt. Vernon Avenue
Colton, CA 92324
714-825-3110

800 Dubuque Avenue
So. San Francisco,
CA 94080
415-871-6373

20201 Sherman Way
Suite 102
Canoga Park, CA 91306
818-709-1775

3878 Ruffin Road
Suite A
San Diego, CA 92123
619-560-9200

COLORADO

1640 South Abilene
Aurora, CO 80012
303-752-2024

FLORIDA

4115 W. Kennedy
Boulevard
Tampa, FL 33609
813-289-9726

GEORGIA

4245 International Blvd.
Suite C
Norcross, GA 30093
404-925-6880

1575 Northside Drive
Suite 325
Atlanta, GA 30318
404-351-8978
(carry-in service only)

ILLINOIS

425 E. Algonquin Road
Arlington Heights, IL 60005
312-981-4840

MARYLAND

Sulphur Spring Business
Park
1638 Sulphur Spring Road
Baltimore, MD 21227
301-242-2607

MASSACHUSETTS

385 University Avenue
Westwood, MA 02090
617-329-4280

MINNESOTA

7850-12th Avenue, South
Airport Business Center
Bloomington, MN 55420
612-854-8624

MISSOURI

13711 Rider Trail North
Earth City, MO 63045
314-739-5301

OHIO

1196 W. Kemper RD
Cincinnati, OH 45240
513-851-4180

PENNSYLVANIA

2250 Cabot Blvd., West
Langhorne, PA 19047
215-741-0661

4986 Library Road, Rt. 88
Hillcrest Shopping Center
Bethel Park, PA 15102
412-343-0555

TENNESSEE

925-8th Avenue, South
Nashville, TN 37203
615-244-4434

TEXAS

7420 Harwin Drive
Houston, TX 77036
713-781-1528

4500 Amon Carter Blvd.
Fort Worth, TX 76155
817-685-1060

WASHINGTON

20425-84th Ave.,
South Kent,
WA 98032
206-872-7922

As of Feb '90

To locate an Authorized Servicer in your area with the U.S.A.

DIAL TOLL FREE: 1-800-447-4700

24 Hours a Day, 7 Days a Week

Consumers requiring assistance with service matters should contact the appropriate Regional Administration Office:

NORTHEAST

2250 Cabot Blvd., West
Langhorne, PA 19047
(215) 741-0676

Covers:

CT, DE, ME, MD, MA,
NH, NJ, NY, PA, RI, VT,
VA, DC, WV, East OH

MIDWEST

425 East Algonquin Road
Arlington Heights, IL 60005
(708) 981-4842

Covers:

IL, IN, IA, KS, KY, MI,
MN, MO, NE, ND, SD,
West OH, WI

WESTERN

6550 Katella Avenue
Cypress, CA 90630
(714) 373-7440

Covers:

AK, AZ, CA, CO, HI, ID,
MT, NV, NM, OR, UT,
WA, WY

SOUTHERN

1854 Shackelford Court,
Suite 105 Norcross, GA 30093
(404) 925-6860

Covers:

AL, AR, FL, GA, LA,
MS, NC, SC, TN, TX,
OK

Consumers requiring product information or operating assistance with a consumer product should contact:

CONSUMER AFFAIRS DEPARTMENT 2F-3

50 Meadowland Parkway Secaucus, N.J. 07094 (201) 348-9090

QUASAR MONITOR VCR LIMITED WARRANTY

Quasar Company will repair this product, free of charge in the U.S.A. in the event of a defect in materials or workmanship as follows:

Parts

New or rebuilt parts in exchange for defective parts for one (1) year from the date of original purchase.

One Year Extended Warranty on Picture Tube

New or rebuilt picture tube in exchange for a defective picture tube during the second (2nd) year after original purchase; purchaser pays for all labor charges for removal and installation of picture tube.

Batteries (If included)

New rechargeable batteries in exchange for defective rechargeable batteries for ten (10) days from the date of original purchase. Non-rechargeable batteries are not warranted.

Tape (If included)

New Video cassette tape in exchange for a defective video cassette tape for five (5) days from the date of original purchase.

Labor

Carry-in or mail-in service for ninety (90) days from the date of original purchase. After the ninety (90) day labor warranty period is over, purchaser pays for all labor charges for removal and installation of parts and picture tube.

Carry-in or mail-in service in the continental U.S.A. can be obtained during the warranty period by contacting a Matsushita Services Company (MSC) Factory Servicenter listed in the Servicenter Directory. Or call 800-447-4700, toll free, to locate an authorized MSC Servicenter. Carry-in or mail-in service in Hawaii or Puerto Rico can be obtained during the warranty period by calling the telephone numbers listed in the Servicenter Directory.

This warranty is extended only to the original purchaser. A purchase receipt or other proof of date of original purchase will be required before warranty performance is rendered.

This warranty only covers failures due to defects in materials or workmanship which occur during normal use and does not cover damage which occurs in shipment or failures which are caused by products not supplied by Quasar or failures which result from accident, misuse, abuse, neglect, mishandling, misapplication, alteration, faulty installation, set-up adjustments, improper antenna, inadequate signal pick-up, maladjustment of consumer controls, modification, or commercial use such as hotel, office or rental use of the product, or service by anyone other than a MSC Factory Servicenter or authorized MSC Servicenter or damage that is attributable to acts of God.

Limits and Exclusions

There are no express warranties except as listed above. QUASAR SHALL NOT BE LIABLE FOR INCIDENTAL OR CONSEQUENTIAL DAMAGES (INCLUDING, WITHOUT LIMITATION, DAMAGE TO TAPES, RECORDS, OR DISCS) RESULTING FROM THE USE OF THIS PRODUCT, OR ARISING OUT OF ANY BREACH OF THIS WARRANTY. ALL EXPRESS AND IMPLIED WARRANTIES, INCLUDING THE WARRANTIES OF MERCHANTABILITY AND FITNESS FOR A PARTICULAR PURPOSE, ARE LIMITED TO THE APPLICABLE WARRANTY PERIOD SET FORTH ABOVE.

If you ship the product

Carefully pack and send it prepaid, adequately insured and preferably in the original carton. Attach a postage-affixed letter, detailing the complaint, to the outside of the carton.

DO NOT send the product to the Executive or Regional Sales offices. They are NOT equipped to make repairs.

Service in Puerto Rico

PSC
San Gabriel Industrial Park
65th Infantry Avenue KM. 9.5
Carolina, Puerto Rico 00630
(809) 750-5135

Service in Hawaii

Please contact the dealer from whom you purchased this product to obtain service information.



ACCESSORIES

SPECIFICATIONS

Check to be sure the following items are packed with your MONITOR-VCR.

ACCESSORIES SUPPLIED

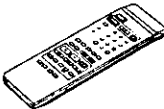
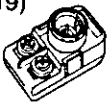
These accessories are provided to help you use or set up your MONITOR-VCR.

1 pc. Wireless Remote Control and 2 "AA" batteries (VSQS0718) 	1 pc. 300 ohm - 75 ohm Transformer (VSQS0198, VSQS0513 or VSQS0519) 
1 pc. Indoor Antenna (TSA710006) 	

OPTIONAL ACCESSORIES

This additional accessory is available to you from Quasar or your local Quasar dealer.

- 1/2" Video Cassette Tape

DISPLAY

Picture Tube: 13 inch measured diagonal
90° deflection
Picture Tube

VCR

Video Recording System: 2 rotary heads, helical scanning system
Audio Track: 1 track
Tuner:
Broadcast Channels: VHF 2~13, UHF 14~69
CATV Channels: "A" (14)~"EEE" (64),
"A-5" (95)~"A-1" (99),
"5A" (01), 65~94*

* If you receive the UHF Band through a CATV system, a UHF/VHF Band Separator may be necessary for proper reception.

GENERAL

Power Source: 120 V AC, 60 Hz
Power Consumption: Approx. 85 watts
Television System: EIA Standard NTSC color
Speaker: 3 inches Round Shape 1 piece
Operating Temperature: 41°F~104°F (5°C~40°C)
Operating Humidity: 10%~75%
Dimensions: 14-5/8" (W) × 14-15/16" (H) ×
14-15/16" (D)
372 (W) × 379 (H) × 379 (D)mm
Weight: 13.2 kg (29.1 lbs.)

Designs and specifications are subject to change without notice.

FOR SAFETY'S SAKE: You have a legal description of your MONITOR-VCR when you record it's serial number in the space provided here. The serial number is on the tag located on the back of your MONITOR-VCR. Be sure to retain this manual as your convenient MONITOR-VCR information source.

Date of Purchase _____

Dealer Purchased From _____

Dealer Address _____

Dealer Phone No. _____

Model No. _____

Serial No. _____

Quasar Company, Elk Grove Village, Illinois

Division of Matsushita Electric Corporation of America



Free Manuals Download Website

<http://myh66.com>

<http://usermanuals.us>

<http://www.somanuals.com>

<http://www.4manuals.cc>

<http://www.manual-lib.com>

<http://www.404manual.com>

<http://www.luxmanual.com>

<http://aubethermostatmanual.com>

Golf course search by state

<http://golfingnear.com>

Email search by domain

<http://emailbydomain.com>

Auto manuals search

<http://auto.somanuals.com>

TV manuals search

<http://tv.somanuals.com>