

Quasar®

Video Cassette Recorder
Operating Instructions
Models No. VHQ-401/VHQ-451

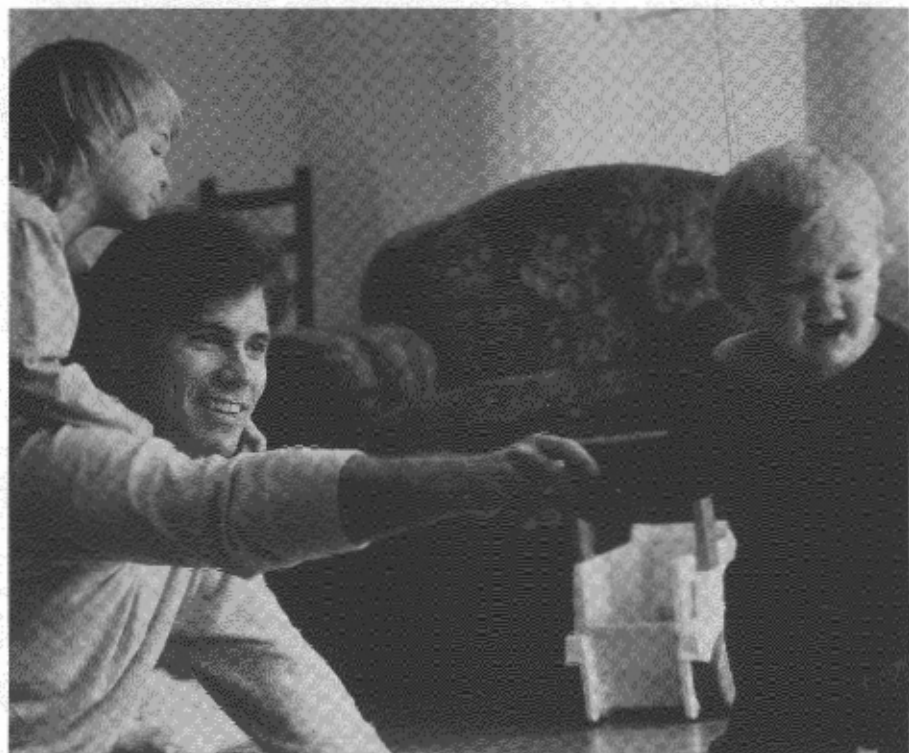

Omnivision VHS



Connections and Initial Setup Procedures are on pages 8 to 9.

As an ENERGY STAR® Partner, Matsushita Electric Corporation of America has determined that this product or product model meets the ENERGY STAR® guidelines for energy efficiency.



Please read these instructions carefully before attempting to connect, operate or adjust this product. Please save this manual.

Spanish Quick Use Guide is included. (Guía para rápida consulta en español está incluida.)

LSQT0330A

Initial Setup
(Connection)

Basic
Operation

Timer
Recording

Advanced
Operation

For Your
Information

Important Safeguards and Precautions

FOR YOUR SAFETY, READ AND RETAIN ALL SAFETY AND OPERATING INSTRUCTIONS. HEED ALL WARNINGS IN THE MANUAL AND ON THE UNIT

INSTALLATION

1 POWER SOURCE CAUTION

Operate only from a power source indicated on the unit or in this manual. If necessary, have your Electric Utility Service Company or Video Products Dealer verify the power source in your home.

2 POLARIZED OR GROUNDING PLUG

As a safety feature, this Video product comes with either a polarized power cord plug (one blade is wider than the other), or a three-wire grounding type plug.

POLARIZED PLUG CAUTION:

This plug will only fit into an outlet one way. If you cannot fully insert the plug, try reversing it. If it still will not fit, have an electrician install the proper wall outlet. Do not defeat the safety feature by tampering with the plug.

GROUNDING PLUG CAUTION:

This plug will only fit into a three-hole grounding outlet. If necessary, have an electrician install the proper outlet. Do not defeat the safety feature by tampering with the plug.

3 POWER CORD

Make sure power cords are routed so that they are not likely to have anything rest on them, roll over them, or be in the way of walking traffic. If an extension cord is used, make sure it also has either a polarized or grounded plug and that the cords can be securely connected. Frayed cords, damaged plugs, and damaged or cracked wire insulation are hazardous and should be replaced by a qualified service technician. Overloaded outlets and extension cords are fire hazards and should be avoided.

4 DO NOT BLOCK VENTILATION HOLES

Ventilation openings in the cabinet release heat generated during operation. If they are blocked, heat build-up inside the unit can cause failures that may result in a fire hazard or heat damage to cassettes. For protection, follow these rules:

- Never cover ventilation slots or the unit while in use, or operate the unit when placed on a bed, sofa, rug, or other soft surface.
- Avoid built-in installation, such as a book case or rack, unless proper ventilation is provided.

5 AVOID EXTREMELY HOT LOCATIONS OR SUDDEN TEMPERATURE CHANGES

Do not place the unit over or near any kind of heater or regulator, in direct sunlight, inside a closed vehicle, etc.. Do not move the unit suddenly between areas of extreme temperature variation. If the unit is suddenly moved from a cold place to a warm place, moisture may condense in the unit and on the tape.

6 TO AVOID PERSONAL INJURY

- Do not place unsecured equipment on a sloping surface.
- Do not place this unit on any support that is not firm, level, and adequately strong. The unit could fall causing serious injury to a child or adult and damage to the unit.
- An appliance and cart combination should be moved with care. Quick stops, excessive force, and uneven surfaces may cause the appliance and cart combination to overturn.
- Carefully follow all operating instructions and use the manufacturer's recommended accessories when operating this unit or connecting it to any other equipment.



OUTDOOR ANTENNA INSTALLATION

1 SAFE ANTENNA AND CABLE CONNECTION

If an outside antenna or cable system is connected to the equipment, be sure the antenna or cable system is grounded so as to provide some protection against built up static charges and voltage surges. Section 810 of the National Electrical Code, ANS/NFPA 70 (in Canada, part 1 of the Canadian Electrical Code) provides information with respect to proper grounding of the mast and supporting structure, grounding of the lead-in wire to an antenna discharge unit, size of grounding conductors, location of antenna discharge unit, connection to grounding electrodes and requirements for the grounding electrode.

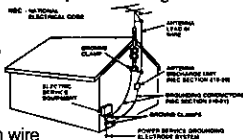

2 KEEP ANTENNA CLEAR OF HIGH VOLTAGE POWER LINES OR CIRCUITS

An outside antenna system should be located well away from power lines, electric light or power circuits and where it will never come into contact with these power sources if it should happen to fall. When installing an outside antenna, extreme care should be taken to avoid touching power lines, circuits or other power sources as this could be fatal. Because of the hazards involved, antenna installation should be left to a professional.

USING THE VIDEO UNIT

If the unit has been in storage or moved to a new location, refer first to the **INSTALLATION** section of these safeguards.

1 KEEP THIS VIDEO UNIT AWAY FROM WATER OR MOISTURE OF ANY KIND.

2 **IF EQUIPMENT IS EXPOSED TO RAIN, MOISTURE, OR STRONG IMPACT**, unplug the unit and have it inspected by a qualified service technician before use.

3 DURING AN ELECTRICAL STORM

During a lightning storm, whether indoors or outdoors, or before leaving the unit unused for extended periods of time, disconnect all equipment from the power source as well as the antenna and cable system.

4 WHEN THE UNIT IS PLUGGED IN

- Never expose the unit to rain or water. **DO NOT OPERATE** if liquid has been spilled into the unit. Immediately unplug the unit, and have it inspected by a service technician. Fire and shock hazards can result from electrical shorts caused by liquid contact inside.
- Never drop or push any object through openings in the unit. Some internal parts carry hazardous voltages and contact can cause electric shock or fire hazard.
- Avoid placing the unit directly above or below your TV set as this may cause electrical interference. Keep all magnets away from electronic equipment.

5 USING ACCESSORIES

Use only accessories recommended by the manufacturer to avoid risk of fire, shock, or other hazards.

6 CLEANING THE UNIT

Unplug the unit. Then, use a clean, dry, chemically untreated cloth to gently remove dust or debris. **DO NOT USE** cleaning fluids, aerosols, or forced air that could over-spray, or seep into the unit and cause electrical shock. Any substance such as wax, adhesive tape, etc. may mar the cabinet surface. Exposure to greasy, humid, or dusty areas may adversely affect internal parts.

SERVICE

1 DO NOT SERVICE THIS PRODUCT YOURSELF

If, after carefully following the detailed operating instructions, this Video product does not operate properly, do not attempt to open or remove covers, or make any adjustments not described in the manual. Unplug the unit and contact a qualified service technician.

2 IF REPLACEMENT PARTS ARE REQUIRED

Make sure the service technician uses only parts specified by the manufacturer, or those having the same safety characteristics as the original parts. The use of unauthorized substitutes may result in fire, electric shock, or other hazards.

3 HAVE THE SERVICE TECHNICIAN PERFORM A SAFETY CHECK

After any service or repairs to the unit, request the service technician to conduct a thorough safety check as described in the manufacturer's service literature to insure that the video unit is in safe operating condition.

Safety Precautions

Warning: To prevent fire or shock hazard, do not expose this equipment to rain or moisture.

CAUTION: To prevent electric shock, match wide blade of plug to wide slot, fully insert.

Avertissement: Afin de prévenir tout risque d'incendie ou de chocs électriques, ne pas exposer cet appareil à la pluie ou à une humidité excessive.

Attention: Pour éviter les chocs électriques, introduire la lame la plus large de la fiche dans la borne correspondante de la prise et pousser jusqu'au fond.

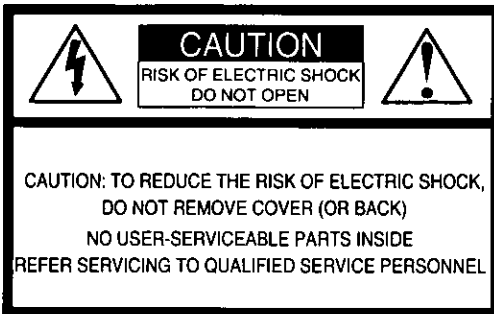

This symbol warns the user that uninsulated voltage within the unit may have sufficient magnitude to cause electric shock. Therefore, it is dangerous to make any kind of contact with any inside part of this unit.



This symbol alerts the user that important literature concerning the operation and maintenance of this unit has been included. Therefore, it should be read carefully in order to avoid any problems.

Note to CABLE system installer:

This reminder is provided to call the CABLE system installer's attention to Article 820-40 of the NEC in USA (and to the Canadian Electrical Code in Canada) that provides guidelines for proper grounding and, in particular, specifies that the cable ground shall be connected to the grounding system of the building, as close to the point of cable entry as practical.

FCC Warning: Any unauthorized changes or modifications to this equipment would void the user's authority to operate.

Before Using

Congratulations

on your purchase of one of the most sophisticated and reliable products on the market today. Used properly, it will bring you years of enjoyment. Please fill in the information below. The serial number is on the tag located on the back of your VCR.

- Date of Purchase _____
- Dealer Purchased From _____
- Dealer Address _____
- Dealer Phone No. _____
- Model No. _____
- Serial No. _____

Accessories

- Remote Control
LSSQ0265 (VHQ-401)
LSSQ0266 (VHQ-451)
- Batteries 2 "AA"

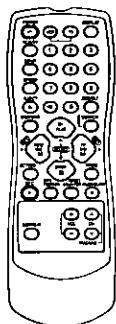

Model VHQ-451 remote shown.

- RF Coaxial Cable
VJAS0196



To order accessories, call toll free 1-800-332-5368.

Loading the Batteries

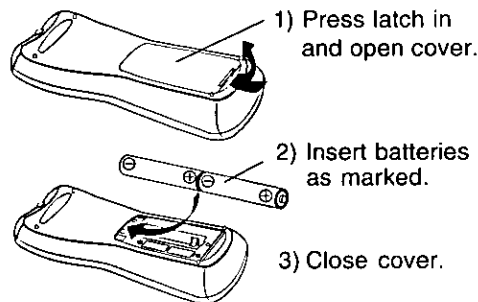

- Battery replacement caution**
 - Do not mix old and new batteries.
 - Do not mix alkaline with manganese batteries.

Prevent Accidental Tape Erasure

Break off the tab to prevent recording.

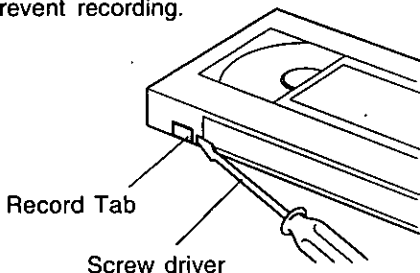

To record again

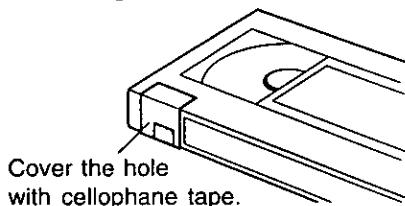

Record/Playback Time

Only use tapes with the **VHS** mark in this unit.

Tape Speed Setting	Type of Video Cassette		
	T60	T120	T160
SP (Standard Play)	1 Hour	2 Hours	2 Hours 40 Minutes
LP (Long Play)	2 Hours	4 Hours	5 Hours 20 Minutes
SLP (SuperLong Play)	3 Hours	6 Hours	8 Hours

Table of Contents

Important Safeguards and Precautions	2,3
Accessories	4
Loading the Batteries	4
Prevent Accidental Tape Erasure	4
Record/Playback Time	4
Location of Controls	6,7
Connections and Initial Setup	8,9

Initial Setup
(Connection)

Reset Language, Channels, Clock, VCR's Output Channel	10,11
Playback a Tape	12
Record On a Tape	13

Basic
Operation

Timer Recording	14,15
-----------------------	-------

Timer
Recording

Multi-Brand Control Feature	16
Advanced Connections (Cable/DSS)	17
MTS Broadcast/ VHS Hi-Fi Stereo System	18,19
(For model VHQ-451 only)	
Tape Operation (Search System)	20~22
Special VCR Features	22,23
Copying Your Tapes (Dubbing)	24

Advanced
Operation

VCR & Cassette Information	25
On-Screen Displays (OSD)	26
Before Requesting Service	27
Service Center List	28
Warranty	29
Spanish (Español) Quick Use Guide	30,31
Index	Back Cover

For Your
Information

Multi Function Display

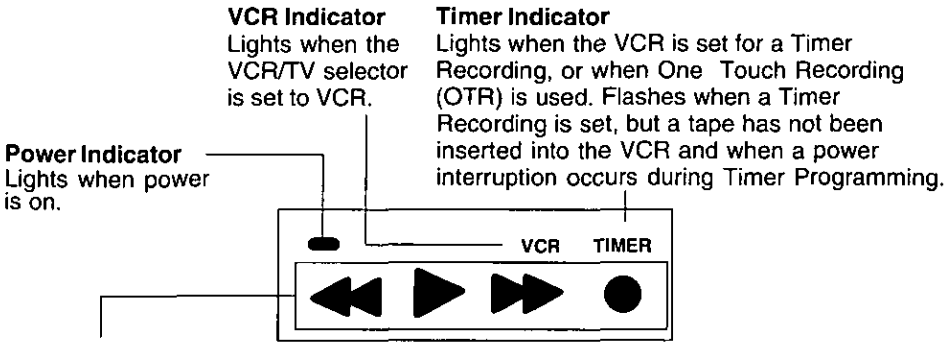

Function Indicator
Shows what the VCR is doing.

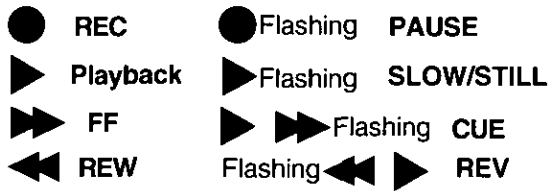

Rear View of the VCR

AC Power Plug

While plugged into an AC outlet, the VCR consumes 3.0 W(VHQ-451) [2.5 W(VHQ-401)] of electrical power in off condition.

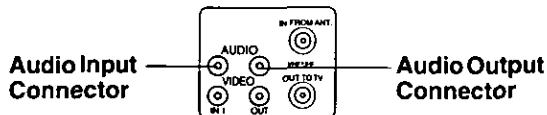
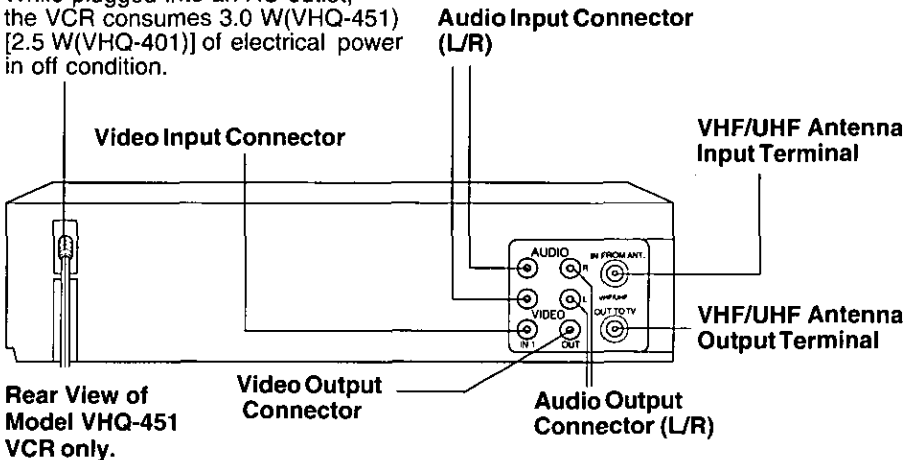

Connections and Initial Setup

How to Connect

Initial Setup for ANT./Cable - VCR - TV

- 1 Connect the Cable from Antenna/Cable to the IN FROM ANT. terminal on VCR.
- 2 Connect the OUT TO TV terminal on the rear of VCR to the ANT. IN terminal on TV using the RF Cable (included accessory).

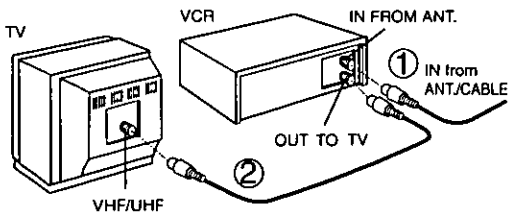

Initial Setup for DSS/Cable Box-VCR-TV

- 1 Connect the OUT Jack on your cable box to the IN FROM ANT. terminal on the VCR with an RF cable.
- 2 Connect the OUT TO TV terminal on the rear of VCR to the ANT. IN terminal on TV using the RF Cable (included accessory).

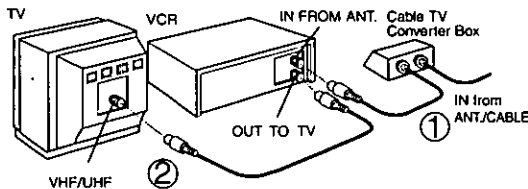

How to do Initial Setup

- 1 Press VCR* for VCR mode. Turn the TV on and set it to channel 3.
- 2 Turn VCR on. When VCR is turned on the first time, SELECT LANGUAGE screen appears.

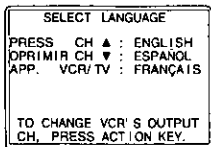

- 3 Press CH▲ to select English. or Press CH▼ to select Spanish. or Press VCR/TV key to select French. When one of above keys is pressed, CHANNEL/CLOCK AUTO SET screen appears.

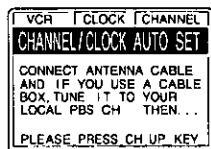

- If screen does not appear, check connection between VCR and TV and, if TV is tuned to channel 3, try switching it to channel 4.
- When you want to change the output channel of VCR, please refer to VCR's Output Channel on page 11.
- If wrong language is set, do "Reset All VCR Memory Functions" steps on page 9.

If you use a cable box, turn it on and set it to the Public Broadcasting Station (PBS) channel in your time zone. If you use DSS receiver, it must be turned off.

WARNING

When using "Nut type" RF coaxial cables, tighten with fingers only. Overtightening may damage terminals.

*Important: If a remote control does not work when pressed, press the VCR button on the remote and try the button again.

- 4** Press CH▲ Key to start Channel/Clock Auto Set operation. Settings are performed automatically. If the setup is completed, the following screen is displayed.

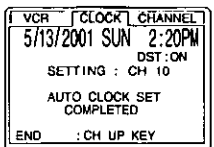

If "Auto Clock Set is Incomplete" screen appears, set the clock using MANUAL CLOCK SET procedure shown below.

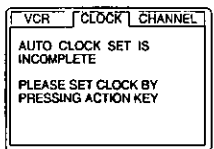

Manual Clock Set

If Auto Clock Set was incomplete, manually set the clock as follows.

- 1** Press ACTION Key on the Remote to display CLOCK Menu screen.

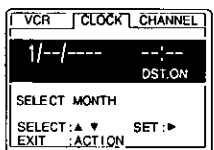

- 2** Press ▲▼ to select the month and ► to set. In the same manner, select and set the date, year, time, and DST (daylight saving time).

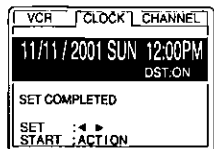

- 3** Press ACTION Key twice to start CLOCK and exit.

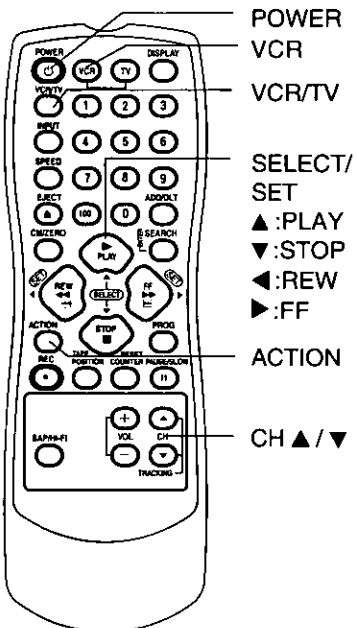

Model VHQ-451 remote shown.

Reset All VCR Memory Functions

Use when moving VCR to new location, or if a mistake was made in the Initial Setup section.

- Make sure a tape is not inserted in the VCR.

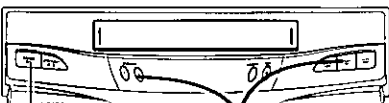

- 1** Turn VCR Power on.

- 2** Press and hold both **PLAY** and **CHANNEL ▲** on the VCR for more than 5 seconds.
- The power shuts off.

- 3** Do "Initial Setup" on page 8.

Initial Setup
(Connection)

Reset Language, Channels, Clock,

1

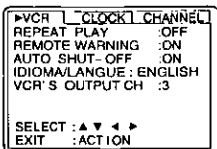

Press **ACTION***
to display menu.

2

■ Language

- 1) Press ▲▼ to select language item.

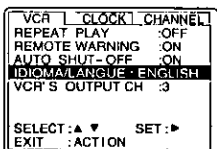

- 2) Press ► repeatedly.

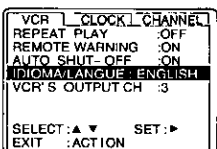

For English



For Spanish

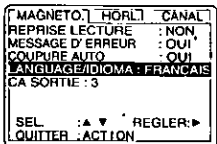

For French

- 3) Press ACTION to exit.

■ Channels

- 1) Press ◀▶ to select CHANNEL.

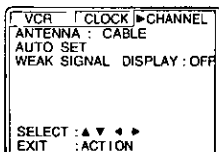

- 2) Press ▲▼ to select "ANTENNA," then press ► to set your antenna system (TV or CABLE).

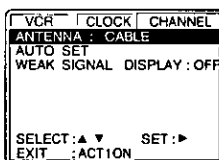

- 3) Press ▲▼ to select "AUTO SET," then press ►.

- If you use a cable box, set it to the PBS channel in your time zone.

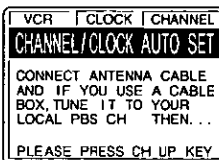

(This screen appears only when auto clock is set.)

- 4) Press CH ▲.

- After Channel Auto Set is finished, Clock Auto Set will be performed.

■ Clock

- 1) Press ◀▶ to select CLOCK.

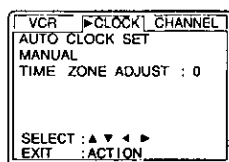

- 2) Press ▲▼ to select MANUAL and press ►. (For Auto Clock Set, select "AUTO CLOCK SET," then press CH ▲.)

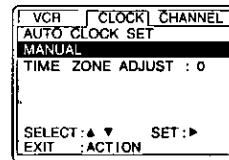

("TIME ZONE ADJUST" appears only when auto clock is set.)

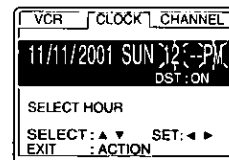

- 3) Press ▲▼ and ◀▶ to select and set the date, time, and DST (Daylight Saving Time).

- 4) Press ACTION twice to start the clock and exit this mode.

10

VCR's Output Channel

***Important:** If a remote control button does not work when pressed, press the VCR button on the remote and try the button again.

Time Zone Adjust ■ VCR's Output Channel

(Only when Auto Clock is set.)

- 1) Press **◀▶** to select **CLOCK**.

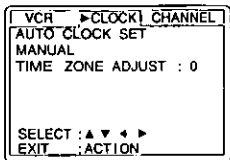

- 2) Press **▲▼** to select **TIME_ZONE ADJUST**

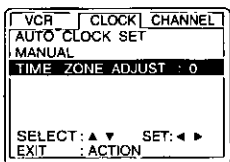

and press **◀** or **▶** to subtract or add hour(s) as necessary.

- 3) Press **ACTION**.

- 4) Press **POWER** off to perform **AUTO CLOCK SET**.

- **TIME_ZONE ADJUST** returns to "0" if clock is set manually.

- 1) Press **▲▼** to select **VCR'S OUTPUT CH**.

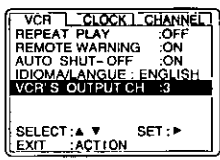

- 2) Press **▶**.

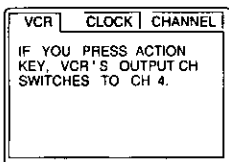

- 3) Press **ACTION**.

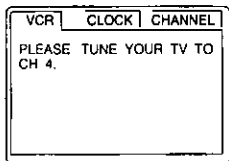

After 3 seconds

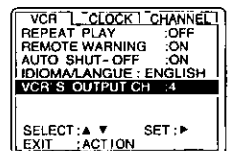

- To Make Corrections, repeat step 1) ~ 3).

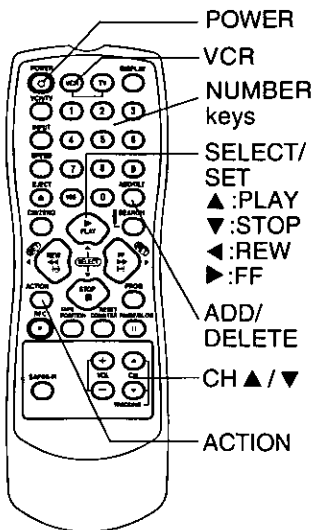

Model VHQ-451 remote shown.

Basic Operation

Add or Delete a Channel

To add channel:

Select channel with number keys and press **ADD/DLT**.

CHANNEL 08 ADDED

To delete channel:

Select channel with **CH ▲/▼** or number keys and press **ADD/DLT**.

CHANNEL 08 DELETED

DST (Daylight Saving Time)

VCR auto adjusts clock for DST. (Page 9.)

Spring (First Sunday in April)

DST:ON --> Sets clock ahead one hour.

Autumn (Last Sunday in October)

DST:ON --> Turns clock back one hour.

- If your area does not observe Daylight Saving Time, select **DST:OFF**.

- Keep these time changes in mind when programming the VCR for timer recordings.

Playback a Tape

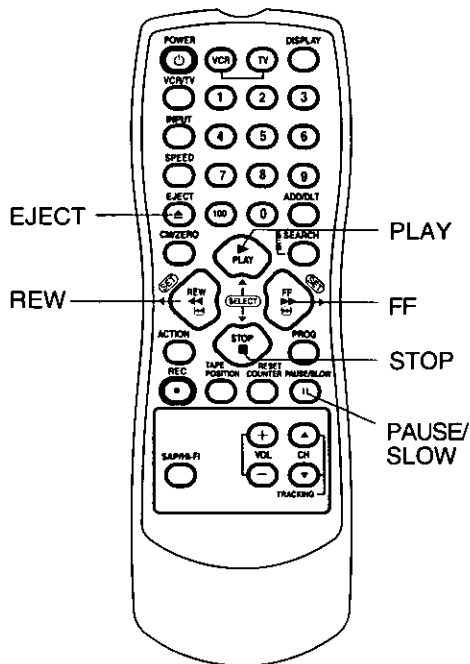

Model VHQ-451 remote shown.

✓ Ready Check List

- All connections are made (pg. 8, 17).
- TV and VCR are plugged in.
- TV is on and tuned to CH3, 4, or VIDEO.
- Remote is in VCR mode. (Press VCR)

- 1** Insert a tape,
 - VCR power comes on.
 - "VCR" lights on Multi Function Display.

- 2** Press **PLAY*** to play tape.
 - If tape has no rec. tab (pg. 4), auto play begins.

Special Features During Play

- **Forward/ Reverse scene search**
--> Press FF or REW.
--> Press again or PLAY to release.
- **Still (Freeze) picture**
--> Press PAUSE/SLOW.
--> Press PLAY to release.
- **Frame by Frame picture**
--> Press PAUSE/SLOW in Still mode.
--> Press PLAY to release.
- **Slow Motion picture**
--> Hold down PAUSE/SLOW in Still mode.
--> Press PLAY to release.

Notes

- These features work best in SP or SLP mode.
- The sound will be muted.
- To reduce picture noise, see "Manual Tracking Control" on page 25.
- After the VCR is in Still or Slow mode for 3 minutes, it will switch to Stop mode automatically to protect the tape and the video head.

Playback using VCR controls

- 1** Insert a cassette.
- 2** Press **PLAY**.

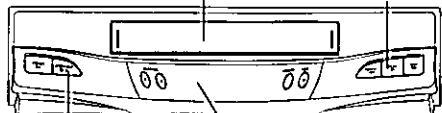

Multi Function Display

- Press **STOP/EJECT** to stop and/ or eject tape.

- 3** Press **STOP** to stop tape.
 - Press **REW** or **FF** In Stop mode to Rewind/ Fast Forward tape.
 - Press **EJECT** on remote, or **STOP/EJECT** on VCR to eject tape.

- Note** Remove loose or peeling labels from tapes to prevent tape jam.

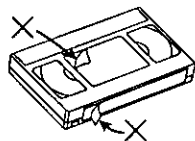

Record On a Tape

*Important:

If a remote control button does not work when pressed, press the VCR button on the remote and try the button again.



Ready Check List

- All connections are made (pg. 8, 17).
- TV and VCR are plugged in.
- TV is on and tuned to CH3, 4, or VIDEO.
- Remote is in VCR mode. (Press VCR)

1

Insert tape with rec. tab (pg. 4).

- VCR power comes on.
- "VCR" lights on Multi Function Display.

2

Press CH ▲▼, or number keys

to select channel.

- For "LINE" input, see pg. 24.
- For channels over 100, press 100 key then press the remaining 2 digits.

3

Press SPEED

to select record speed (pg. 4).

- SP = Standard Play LP = Long Play
- SLP = Super Long Play
- Speed appears on-screen.

4

Press REC

to start record.

- To edit out unwanted scenes, press PAUSE/SLOW to pause, and again to resume recording.

5

Press STOP

to stop record.

■

One Touch Recording (record in progress),

- VCR shuts off after preset record length.
- > each press of REC adds 30 min. to record length up to 4 hours.

■

Record one station, watch another,

- > press VCR/TV ("VCR" goes out on Multi Function Display),
- > select channels at TV (recording continues).

Note

- **Watching one channel and recording another is NOT possible when using a Cable Box or a Satellite Receiver.**

■

Select channels at VCR,

- Other channels cannot be viewed during recording.
- > press VCR/TV ("VCR" lights on Multi Function Display),
- > select channels at VCR.

Note

- After 5 min. in Pause mode, VCR stops to protect tape and video head.

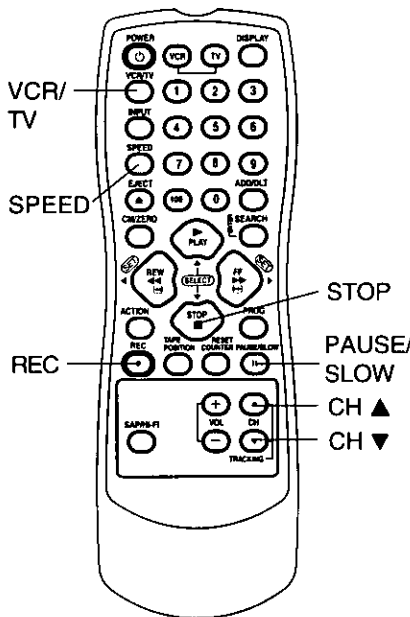

Model VHQ-451 remote shown.

Record using VCR controls

- 2 Select Channel.
- 1 Insert a cassette.
- 4 Press REC to start Recording.

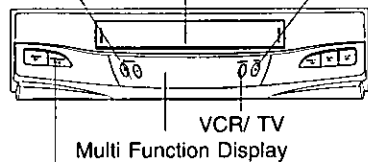

- 5 Press STOP/EJECT to stop.

This video recorder, equipped with HQ (High Quality) system, is compatible with existing VHS equipment. Only use tapes with the **VHS** mark. Only tapes tested and inspected for use in 2, 4, 6, and 8 hour machines are recommended.



Ready Check List

- All connections made (pg. 8, 17).
- TV and VCR plugged in and turned on.
- VCR/TV selector set to "VCR."
- Clock set correctly.
- Tape has rec. tab (pg. 4).
- Remote in VCR mode. (Press VCR)

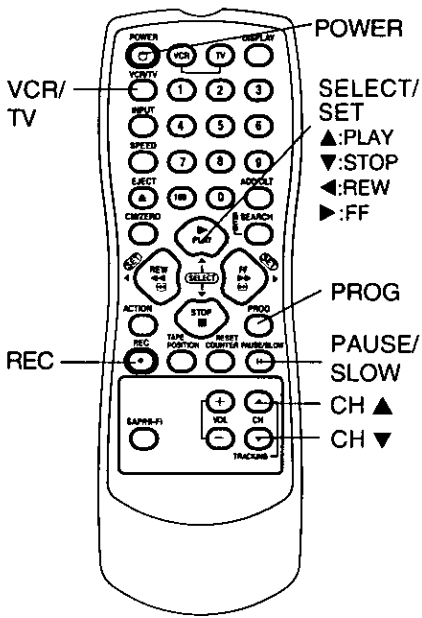

Model VHQ-451 remote shown.

1 Press PROG*
to display PROGRAM.

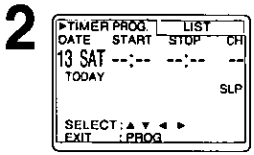

Press ▼
to display Program screen.

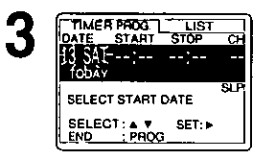

1) To set record DATE, press ▲▼ to select:
1~31= one time, or
DAILY= MON~ FRI, or
WEEKLY= same time each week
and press ► to set.
• See selection order below left.

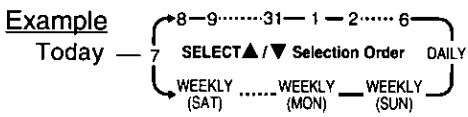

2) To set remaining items, press ▲▼ to select and press ► to set START/ STOP times, CH(channel) or LINE input (pg.24), and tape speed (SP, LP, SLP).

Press PROG
to end program.

Notes

- If you are using a Cable Box, VCR Timer Programming Channel(Step 3) must be set to the Cable Box output channel AND your Cable Box must be manually set to the desired channel. The Cable Box power left on.
- If a power interruption occurs while programming the timer, the timer program(s) may be canceled. If "TIMER PROGRAMS WERE LOST DUE TO POWER INTERRUPTION" appears on-screen, please reenter the timer programs.

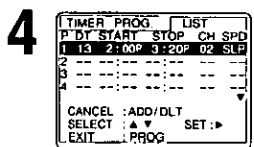

To Enter More Programs, press ▲▼ to select and press ► to set an unused program number and repeat step 3.

Or
Press PROG again
to exit.

5 Press POWER off
to set the timer.
(“TIMER” lights on Multi Function Display.)

Review, Replace or Clear Program Contents:

(Recording is not in progress)

1

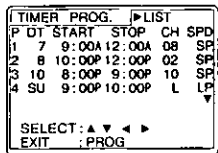

- 1) Press **PROG.**
- 2) Press **◀▶** to select **LIST**.

To cancel a Timer Recording in progress...

Press **POWER** and then **STOP** within 10 seconds to cancel the Timer recording. (The **TIMER** indicator goes out on Multi Function Display.)

2

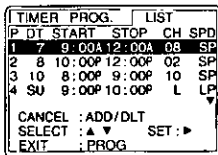

- Press **▲▼** to select number.

3 To Replace program...



- 1) Press **▶** to display.
- 2) Repeat Step 3 (pg. 14) to set new programs.

or

To Clear program...

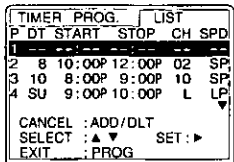

- Press **ADD/DLT**.

4 Press PROG

to end the program.

- If there are set programs, press **POWER** off to set timer.

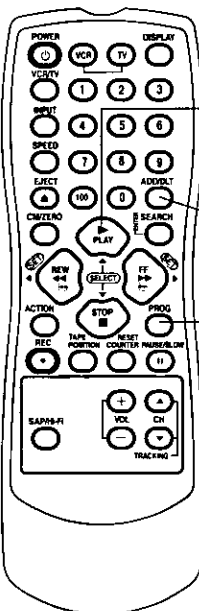

SELECT/
SET
▲:PLAY
▼:STOP
◀:REW
▶:FF

ADD/DLT

PROG

Timer Recording

Model VHQ-451 remote shown.

Important notes when using a DSS receiver

- When recording programs via a DSS receiver, the DSS receiver must be left on.
- When recording programs via an antenna or cable, the DSS receiver must be turned off.

Multi-Brand Control Feature

Multi-Brand Control Setup

The Remote Control can be set to control some TV functions.

1 Find your TV Brand Code Number shown below.

2 ■ Setup for TV control,
 -->hold down TV button,
 -->enter code with number keys.

- If code number is 100 or greater,
 -->press 100 key, then other digits.
 E.g., press 100 - 0 - 2 for 102.

3 Confirm code entry,
 -->press POWER to turn selected unit on or off.
 • See table below for controllable functions in each mode.

- Notes**
- Repeat setup after remote battery replacement.
 - Remote will not control every TV made by the manufacturer listed. If you get no response, your particular unit cannot be controlled. There are NO additional codes for the products listed. If your product is not listed, then the remote is not compatible with that product.

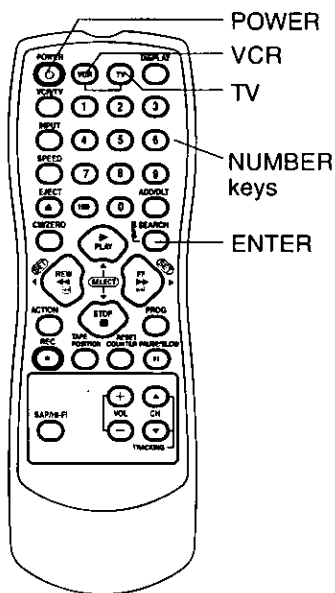

Model VHQ-451 remote shown.

Using Multi-Brand Control

After remote is set up, you can select VCR or TV for the desired function.

Press VCR or TV on the remote.
 (Table below shows available unit buttons for each mode.)

Unit Mode	VCR	TV
VCR	All	VOL UP/DOWN
TV	VCR/TV, PLAY, STOP EJECT, SAP/ Hi-Fi (VHQ-451 only), DISPLAY, FF, REW, PAUSE/SLOW, REC, SPEED, CM/ZERO, RESET COUNTER, TAPE POSITION	POWER, INPUT, number keys, ENTER, CH UP/DOWN, VOL UP/DOWN

Notes

- Not all functions listed may be controllable.
- In TV mode, it may be necessary to press ENTER after pressing number keys for channel selection.

TV Brand Code Numbers

Panasonic..... 01, 02	Sylvania..... 05	JVC..... 11
Quasar..... 01, 02	Sharp..... 06, 07	Hitachi..... 12
RCA..... 03	Sony..... 08	Mitsubishi..... 07, 13
GE..... 03	Toshiba..... 09	Samsung..... 14
Zenith..... 04	Sanyo..... 10	Gold Star..... 15, 16, 17
Magnavox..... 05	Fisher..... 10	

Important Notes

- Due to changes in infra-red commands used by manufacturers, some brands have several codes. If your unit does not respond to the first code, please try the next one.
- Some TV brands require you to turn on the power manually.

Advanced Connections

Audio/Video connection

If your TV has AUDIO IN and VIDEO IN terminals, you can connect your VCR to them to receive higher quality picture and sound.

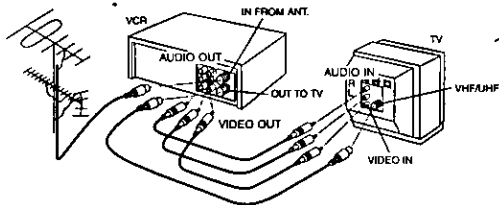

For Model VHQ-451 only

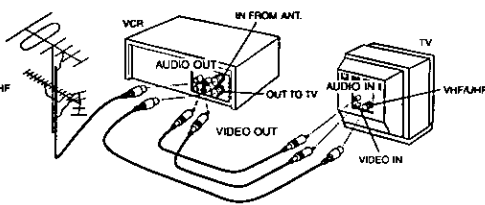

For Model VHQ-401 only

- 1 Connect the VIDEO OUT terminal on the VCR to the VIDEO IN terminal of your TV.
- 2 Connect the "L" and "R" AUDIO OUT terminals on the VCR to the "L" and "R" AUDIO IN terminals of your TV. (VHQ-451 Rear)
Connect the AUDIO OUT terminal on the VCR to the AUDIO IN terminal of your TV. (VHQ-401 Rear)
- 3 Set the VIDEO/TV selector of your TV (Monitor/Receiver) to "VIDEO."

With a Cable Box (VCR ↔ Cable Box)

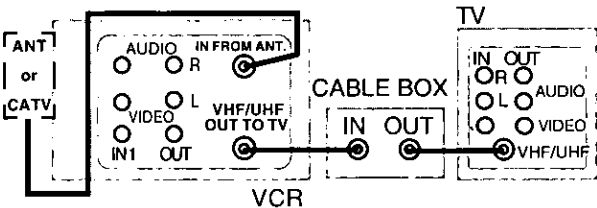

You Can

- view any (including scrambled) channel.
- use VCR Remote Control to select channels without using Multi-brand control feature.

You Cannot

- record scrambled channels.

Connect With Two Cable Boxes

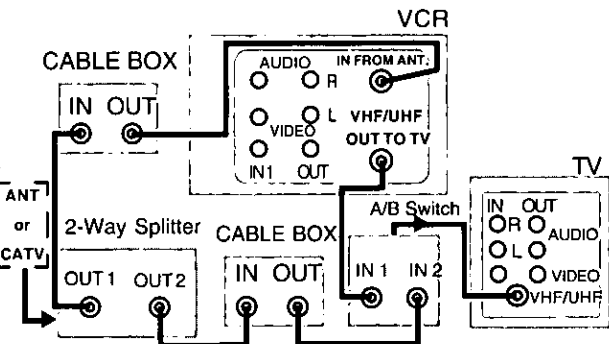

You Can

- record and view both scrambled and unscrambled channels if additional equipment is added. This connection requires: two converter boxes, an A/B switch, and a 2-way splitter.

You Cannot

- view channel other than the one selected for any type of recording.
- do a Timer recording of a channel unless you select it at the cable box.

Advanced Operation

MTS Broadcast/VHS Hi-Fi Stereo System

Connection

For Model VHQ-451 only

Make the Audio/Video Connection as shown on page 17.

- You can use a TV connected to Stereo amp and speakers instead of a Stereo TV.

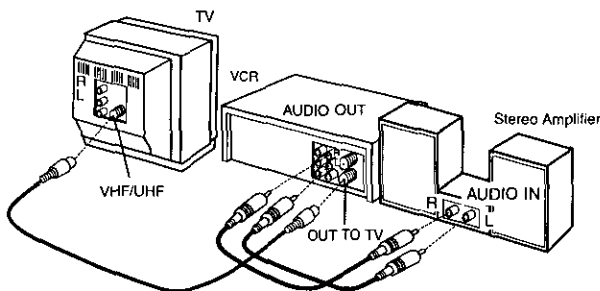

Receivable Broadcast Types

The following are possible audio broadcast types and on-screen displays.

The signal being received is indicated with an "R" mark while the selected audio mode is indicated with an arrow.

To display the broadcast signal being received, --> press DISPLAY.

MTS Stereo and SAP broadcast

Multi-channel Television Sound Stereo (main language) and Secondary Audio Program (sub language) broadcasts are being received simultaneously. Select STEREO or SAP audio mode.

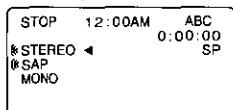

MTS Stereo broadcast

Multi-channel Television Sound Stereo broadcast. Select STEREO audio mode.

- If stereo broadcast is weak and display flickers, select MONO audio mode for possibly better results.

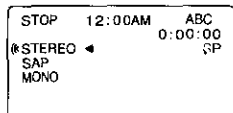

SAP broadcast

Secondary Audio Program (sub language) broadcast. Select SAP audio mode for the sub language.

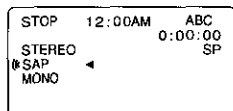

MONO broadcast

Normal monaural sound broadcast.

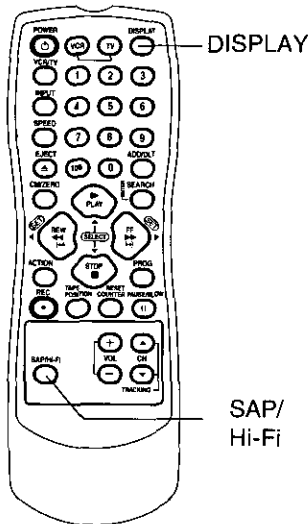
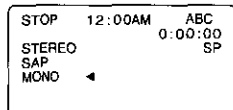

Equipped with **dbx**[®]-TV Noise Reduction for true MTS reproduction. **dbx**[®]-TV Noise Reduction is required for good stereo separation and audio fidelity. **dbx**[®] is a registered trademark, and is licensed by **dbx**[®] Technology Licensing.

Audio Mode for Recording

- 1 Press **SAP/ Hi-Fi** to display audio mode.
(Display disappears after 5 seconds.)

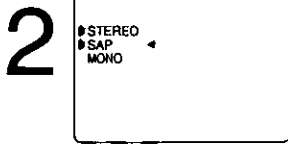

Press **SAP/ Hi-Fi** repeatedly to select desired mode.

- Arrow indicates selection.

- Refer to "Receivable Broadcast Types" on page 18.

- 3 Do a recording.
See page 13.

Audio Mode for Playback

- 1 Start playback.
See page 12.

- 2 Press **SAP/ Hi-Fi** to display audio mode.
(Display disappears after 5 seconds.)

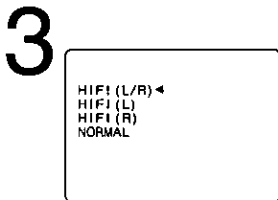

Press **SAP/ Hi-Fi** repeatedly to select desired mode.

- Arrow indicates selection.

- Select "HIFI(L/R)" or "HIFI(L)" or "HIFI(R)" to listen to stereo recordings in stereo sound. Select "NORMAL" for monaural sound.

Notes

- Only tapes recorded in Hi-Fi stereo will playback with true stereo sound. Standard stereo tapes will playback in monaural sound.
- To listen to Hi-Fi stereo playback, the VCR AUDIO (L/R) jacks must be connected to a stereo TV or an external stereo amp and speakers. (See page 18.)
- If tracking is adjusted during playback, Hi-Fi audio may revert to normal audio.
- Hi-Fi and normal audio playback volume level may differ.

Download from www.Somanuals.com. All Manuals Search And Download.

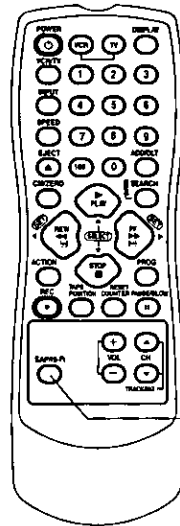

SAP/Hi-Fi

Tape Operation

Search System

For each recording, an invisible index mark is placed on the tape. A program index and information are also included for timer recordings. These marks are used to access or scan recordings.

Index Search

1

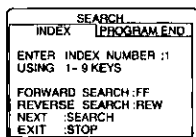

Press **SEARCH*** to display SEARCH in Stop or Play mode.

2



Press number keys to select recording number.

- To calculate number, see below.

Press **FF** or **REW** to start search.

3

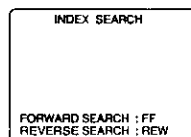

- Play begins at search end. To search forward or back 1 index, press **FF** or **REW** while screen left is displayed (10 sec.).

To Calculate Index Number

Example 1:

To go to rec. 2 from rec. 4, enter 3 and press REW.

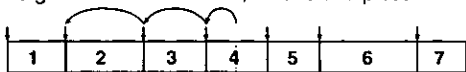

Example 2:

To go to rec. 6 from rec. 2, enter 4 and press FF.

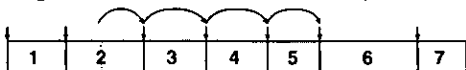

NOTE: ↓ indicates start points of each recording.

Note

- If Index Search is started very close to an index mark, that index mark may not be counted in the search.

Program End Search

Locates end point of recording for continuity.

- Press **SEARCH** twice to display SEARCH in Stop or Play mode.

2

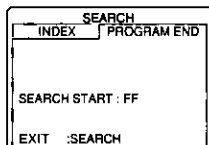

Press **FF** to start PROGRAM END SEARCH.

Examples of Program End Search.

Fig. 1

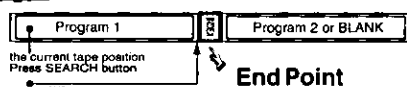

Fig. 2

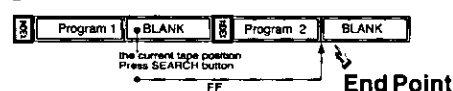
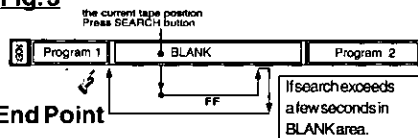

Fig. 3



Upon locating end point,

- >search continues 7 sec. past end point,
- >tape rewinds to 10 sec. before end point,
- >tape plays to end point and stops.

Notes

- If Program End Search is started very close to an index mark, that mark may be skipped over.
- To cancel, press **PLAY** or **STOP**.

***Important:** If a remote control button does not work when pressed, press the VCR button on the remote and try the button again.

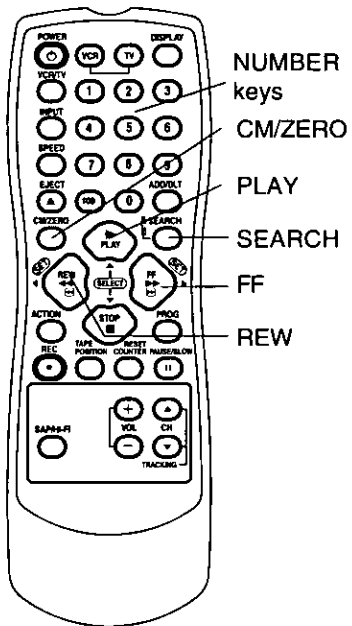

Model VHQ-451 remote shown.

Auto Operation Functions

■ Auto Play

Insert tape --> Power comes on,
--> Play starts if no record tab
(see pg. 4).

■ Auto Rewind

Play
Manual Record } --> Tape end,
Fast Forward } --> Rewind

■ Play Auto Eject

(Repeat Play must be off)
Play, --> Tape end, --> Rewind,
--> Tape ejects if no record tab

Commercial Skip

VCR fast forwards (skips) over 1~3 minutes of recorded tape.

1 Press CM/ZERO in Play mode.

- The skip time can be changed by pressing CM/ZERO button repeatedly as shown by the figure below.

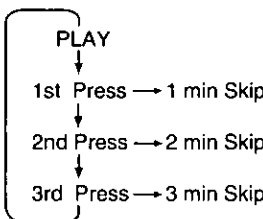

- No indication appears.

Repeat Play

Set to playback a recording over and over.

- 1 Press **ACTION*** to display menu.

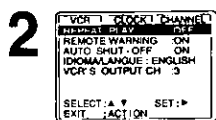

- 2 Press **▲▼** to select **REPEAT PLAY** and press **▶** to set ON or OFF.

- Play repeats at tape end or if unrecorded portion over 30 sec. is detected.

- 3 Press **ACTION** to return to normal screen.

Zero Search

To quickly return to a specified tape location.

- 1 Press **DISPLAY** during play to display Counter.

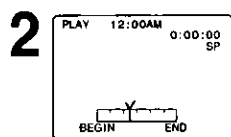

- 2 Press **RESET COUNTER** at desired position to reset to "0:00:00".

- 3 Continue to record, playback, etc.

- 4 Press **Stop**.

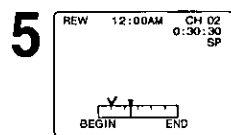

- 5 Press **CM/ZERO** in Stop mode to start **ZERO SEARCH**.

- Unit will go into FF or REW mode and stop at the last point the Counter was set to 0:00:00.

Note

- If a blank portion exists on the tape, and depending on the position of the V mark, the V mark display position may not be accurate.

Tape Position Display Feature

To find out the present tape position.

Tape position cannot be detected for VHS-C Cassette type and tapes less than 60 minutes in length.

- 1 Press **TAPE POSITION** to detect tape position.

DETECTING TAPE POSITION

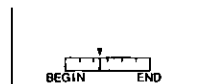

- "DETECTING TAPE POSITION" only appears the first time a cassette is inserted and it takes several seconds for correct indication to appear.

- The present tape position indication is displayed.

- 2 Press **TAPE POSITION** to return to normal screen.

Remote Warning ON/OFF Feature

If Multi-brand feature is used (page 16), and this feature is set to on, a warning appears whenever an invalid key is pressed in TV mode.

- 1 Press **ACTION** to display menu.

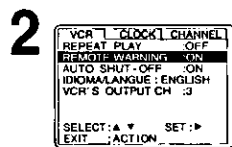

- 2 Press **▲▼** to select **REMOTE WARNING** and press **▶** to set ON or OFF.

- If "OFF," remote warning will not appear if invalid key is pressed.

- 3 Press **ACTION** to return to normal screen.

*Important: If a remote control button does not work when pressed, press the VCR button on the remote and try the button again.

Weak Signal Display ON/OFF Feature

When "ON," picture is displayed regardless of signal strength.

1



Press **ACTION** to display menu.

2

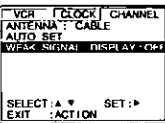

Press **◀▶** to select and display **CHANNEL**, press **▲▼** to select **WEAK SIGNAL DISPLAY**, and press **▶** to set **ON** or **OFF**.

- **ON:** Picture is displayed regardless of signal condition, and may not always be clearly visible.
- **OFF:** Screen turns solid blue when signal is weak or non-existent.
- Selecting **ON** has no effect on connected equipment with blue back feature.

3

Press **ACTION** to return to normal screen.

Auto Shut-Off Feature

When set to **ON**, VCR shuts off if blank tape is played or no signal is detected for 5 min.

1

Press **ACTION** to display menu.

2

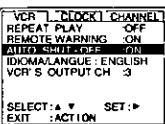

Press **▲▼** to select **AUTO SHUT-OFF** and press **▶** to set **ON** or **OFF**.

3

Press **ACTION** to return to normal screen.

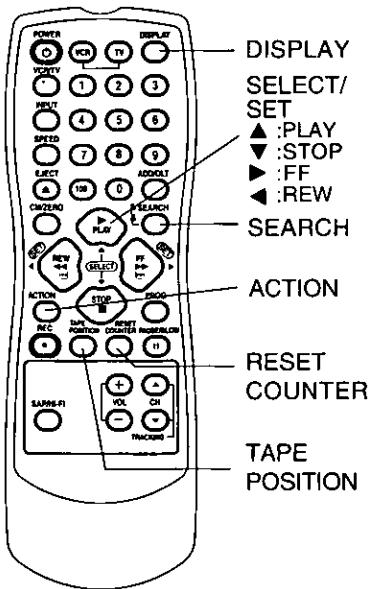

Model VHQ-451 remote shown.

VCR Lock Feature

When set to **ON**, all operations except for timer record and tape eject are prohibited. Useful for households with small children.

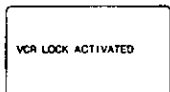

To turn on, hold down **REC** on the VCR in Stop mode with no tape inserted for 7 sec. (Please ignore the **NO CASSETTE** warning.)



To turn off, repeat above.

- VCR Lock cancels in 24 hours if clock is set.



REC

Copying Your Tapes (Dubbing)

Connection

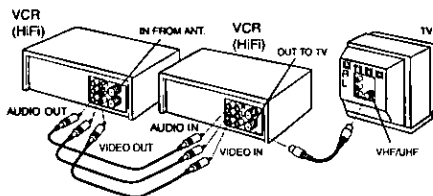

For Model VHQ-451 only

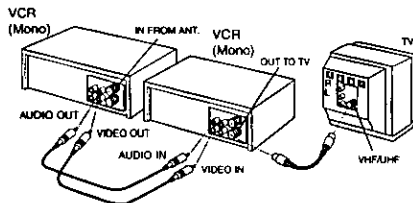

For Model VHQ-401 only

- ① Connect VIDEO OUT terminal on Playing VCR to VIDEO IN terminal on Recording VCR. To monitor the dubbing, also connect a TV as shown.
- ② Connect "L" and "R" AUDIO OUT terminals on Playing VCR to "L" and "R" AUDIO IN terminals on Recording VCR. (VHQ-451 Rear)
Connect AUDIO OUT terminal on Playing VCR to AUDIO IN terminal on Recording VCR. (VHQ-401 Rear)

In place of a Playing VCR, you can use other equipment, such as a Camcorder. Simply connect the unit's Audio/Video outputs to the Recording VCR.

Playing (Source) VCR

Recording (Editing) VCR

1 Insert pre-recorded tape.

Insert blank tape with record tab.

2 _____

Press INPUT to set VCR Input mode to LINE for Video Input. (See "Selecting the Input Mode" below.)

3 Press PLAY, then PAUSE/SLOW immediately to enter PLAY/PAUSE mode.

Press REC, then PAUSE/SLOW immediately to enter REC/PAUSE mode.

The operation of steps 4 and 5 must be done on both playing and recording VCRs at the same time.

4 Press PLAY to start dubbing. Playing VCR starts playback.

Press PAUSE/SLOW to start dubbing. Recording VCR starts recording.

5 Press STOP to stop dubbing.

Press STOP to stop dubbing.

■ To Monitor Dubbing on Your TV

- 1 Turn your TV on and tune to the Recording VCR channel (CH3 or CH4).
- 2 Set the VCR/TV Selector on the Recording VCR to "VCR."

■ Selecting Input Mode

Method 1,
-->press INPUT to switch between channel number and LINE.

Method 2,
-->press CH ▲ / ▼ to change display as follows.

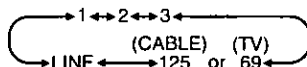

- "L" lights about 4 sec. on front panel when LINE is selected.

Note Dubbing tapes protected with Copy Guard will have poor quality results.

Caution: Unauthorized exchanging and/or copying of copyrighted recordings may be copyright infringement.

VCR & Cassette Information

Head Cleaning

Playing older or damaged tapes may eventually cause video heads to become clogged.

Video Head Clog Sensor

During playback, this screen appears if clogging is detected. To remove screen, press PLAY on the remote or VCR.

VIDEO HEADS MAY
NEED CLEANING
PLEASE INSERT HEAD
CLEANING CASSETTE
OR REFER TO MANUAL

END :PLAY

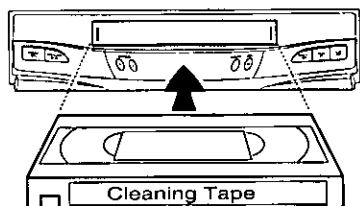

- Use "dry" type head cleaning cassette only. (Part No. NV-TCL30PT is recommended.)
- Follow cleaning tape instructions carefully. Excessive use of tape can shorten head life.
- If head clog symptoms persist, contact your nearest Factory Service Center or authorized Service Center. (See page 28.)

Cleaning the VCR

Use a soft cloth or dusting attachment of a vacuum cleaner to remove dust from the ventilation holes on the back sides and bottom of the cabinet.

Plastic surfaces are easily scratched and can be marred by alcohol and various solvents. Avoid excessive use of oil-based furniture polishes since the materials used in the cabinet will accumulate more dust. We recommend using a nonabrasive, antistatic cleaner and polisher.

Specifications

Power Source: 120 V AC, 60 Hz
Power Consumption: Power On
Approx. 18 watts (VHQ-401)
Approx. 23 watts (VHQ-451)
Power Off
Approx. 2.5 watts (VHQ-401)
Approx. 3.0 watts (VHQ-451)
Video Signal: EIA Standard NTSC color
Video Recording System: 4 rotary heads helical scanning system
Audio Track: 1 track (Normal)
2 channel (Hi-Fi Audio Sound) (VHQ-451)

Tuner:

Broadcast Channels: VHF 2-13, UHF 14-69

CABLE Channels:

Midband A through I (14-22)
Superband J through W (23-36)
Hyperband AA-EEE (37-64)
Lowband A-5-A-1 (95-99)
Special CABLE channel 5 A (01)
Ultraband 65-94, 100-125

Operating Temperature: 5°C-40°C (41°F-104°F)

Operating Humidity: 10%-75%

Weight: 2.5 kg (5.5 lbs).

Dimensions: 360 (W) x 93 (H) x 242 (D) mm
14-3/16" (W) x 3-11/16" (H) x
9-9/16" (D)

Note: Designs and specifications are subject to change without notice.

Features for a Quality Picture

Digital Auto Picture

Automatically controls the video output signal for less noise depending on the tape condition.

Digital Auto Tracking

Continuously analyzes the signal and adjusts for optimum picture quality.

Manual Tracking Control (to reduce picture noise)

Use during Playback and Slow Motion mode to reduce picture noise. Press CH (TRACKING) ▲ / ▼ buttons on the remote control or on the VCR until the picture clears up. To return to Auto Tracking, press POWER off, then on again a few seconds later.

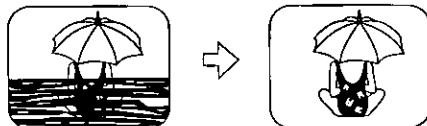

V-Lock Control (to reduce picture jitter)

In Still mode, CH (TRACKING) ▲ / ▼ buttons operate as a V-Lock control.

On-Screen Displays (OSD)

Function & Channel Display

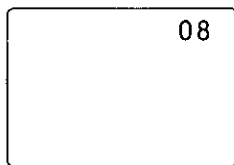

When a function button is pressed, e.g. PLAY, or you change channels, a 4 second display appears first in large and then small characters.

Blank Tape/ No Video Signal Indication

Whenever a blank section of a tape comes up in Play mode, or when the selected channel has no broadcast signal with the Weak Signal Display Feature (page 23) set to OFF, the TV screen will turn solid blue.

VCR Status & Clock Display

To display or remove overlay at right,

--> press DISPLAY.

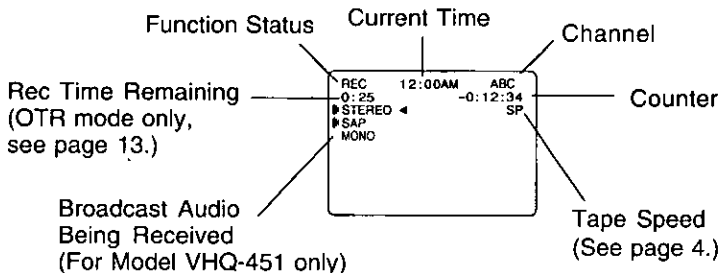

Warning and Instruction Displays

These displays will alert you to a missed operation or provide further instructions.

OSD	Caution	Pg	OSD	Caution	Pg
NO CH FOUND PLEASE CHECK ANTENNA CABLE CONNECTION THEN PRESS CH UP KEY AGAIN	If no active channels are found for CHANNEL MEMORY...	8	TO CANCEL TIMER REC PRESS POWER THEN STOP KEY	If you press POWER or STOP during a Timer Recording... (visible in VCR mode only)	14
PLEASE SET CLOCK BY PRESSING ACTION KEY	If you attempt to set or review a Timer Recording and the Clock is not set...	14	VIDEO HEADS MAY NEED CLEANING PLEASE INSERT HEAD CLEANING CASSETTE OR REFER TO MANUAL END :PLAY	If head cleaning becomes necessary while playing back a tape...	25
TURN VCR OFF FOR TIMER RECORDING	After a Timer Program has been set...	14	VCR LOCK ACTIVATED	If you press a function button other than STOP/EJECT or POWER while the VCR is in VCR Lock mode...	23
CHECK CASSETTE RECORD TAB	If you press REC on the remote control or VCR, and a cassette is inserted with no record tab...	4	REMOTE CONTROL IS SET TO TV MODE USE VCR : VCR KEY	If you press an invalid key on the remote while in TV mode...	16 22
NO CASSETTE PLEASE INSERT A CASSETTE	If you press PLAY, FF, REW, or REC on the remote control or VCR without a cassette inserted...	12 13			

Before Requesting Service

Check the following points once again if you are having trouble with your VCR.

Power	Correction
No power...	<ul style="list-style-type: none"> • Completely insert Power Plug into an AC outlet. • Set POWER button to on. • Make sure power source is active.
Recording & Playback	Correction
TV program cannot be recorded...	<ul style="list-style-type: none"> • Check connections between VCR, external antenna, and TV. • Check connections selection. (P.8, 17) • Make sure your antenna system (CABLE or TV) is correctly set. (Channels [P.10]) • Make sure cassette record tab is intact. (P.4)
Timer recording cannot be performed...	<ul style="list-style-type: none"> • Confirm that clock is set to current time and date. • Make sure Cable/DSS box (if used) is left on and tuned to channel to be recorded. • Set recording start/stop times correctly. (P.14) • Make sure VCR POWER button is pressed off. (P.14) • Timer recording may not be performed or continued if a power interruption occurs before or during a Timer Recording, even after power is restored.
There is no playback picture, or the playback picture is noisy or contains streaks...	<ul style="list-style-type: none"> • Select channel 3 or 4 on TV to match VCR output channel (3 or 4) (P.8) or select LINE. • Set VCR/TV selector to "VCR." • Adjust TRACKING control in either direction. (P.25) • Try Head Cleaning. (P.25)
Special effects playback, picture may contain some vertical jitter when using a TV with an Automatic Vertical Hold Control...	<ul style="list-style-type: none"> • Set TV's Vertical Hold Control to MANUAL, then adjust.
VCR cannot be controlled...	<ul style="list-style-type: none"> • Make sure VCR power is on. • Check Remote batteries. • Make sure VCR LOCK is set to off. (P.23) • Make sure Remote is in proper mode.(P.16) • Make sure Timer Record is not in progress.
Remote Control	Correction
VCR cannot be remote controlled...	<ul style="list-style-type: none"> • Make sure VCR power is on. • Make sure Remote is in VCR mode. • Aim Remote Control directly at remote sensor on VCR. (P.6) • Avoid any object blocking signal path. • Check Remote batteries. (P.4) • Make sure VCR LOCK is set to off. (P.23) • Exposing VCR remote sensor to direct fluorescent or outdoor light may cause signal interference.
ACTION and PROG buttons do not respond...	<ul style="list-style-type: none"> • Check connections between VCR, external antenna, and TV. • Press VCR button for VCR mode. (P.16) • Check Remote batteries. (P.4)
Miscellaneous	Correction
Programs cannot be viewed on TV...	<ul style="list-style-type: none"> • Make sure TV power is on. • Make sure TV is set to output of VCR. • Check connections between VCR, external antenna, and TV. • Set VCR/TV selector to "TV." (P.13) • Make sure proper signal source is selected.
Video cassette cannot be inserted...	<ul style="list-style-type: none"> • Insert the cassette with window side up; record tab facing you. • Check if a tape is already in the unit.
Video cassette cannot be removed...	<ul style="list-style-type: none"> • Completely insert Power Plug into an AC outlet.
Video cassette ejects when a recording is started or the power is turned off for timer recording...	<ul style="list-style-type: none"> • Make sure cassette record tab is intact. (P.4)
In Stop mode, the motor (CYLINDER) continues to rotate...	<ul style="list-style-type: none"> • To enable Quick play mechanism, the cylinder will rotate for about 3 minutes. This reduces response time from Stop to Play mode and from Play to Rewind Search mode.

If you cannot resolve the problem, please call the Customer Call Center for product assistance at 1-800-211-PANA (7262).

To locate an authorized servicenter, please call toll free 1-800-211-PANA (7262), or send e-mail to : consumerproducts@panasonic.com

Service Center List

For Product Information, Operating Assistance, Literature Request, Dealer Locations, and all Customer Service inquiries please contact:

1-800-211-PANA (7262), Monday-Friday 9am-9pm Saturday-Sunday 9am-7pm, EST. or send e-mail to : consumerproducts@panasonic.com

Web Site: <http://www.panasonic.com>

You can purchase parts, accessories or locate your nearest servicenter by visiting our Web Site.

Accessory Purchases:

Customer Orders Only 800-332-5368 (Customer Orders Only)
Panasonic Services Company 20421 84th Avenue South, Kent, WA 98032
(6 am to 5 pm Monday - Friday; 6 am to 10:30 am Saturday; PST)
(Visa, MasterCard, Discover Card, American Express, Check)

Factory Servicenters Locations

CALIFORNIA

6550 Katella Avenue
Cypress, CA 90630

800 Dubuque Avenue
S. San Francisco,
CA 94080

20201 Sherman Way
Suite 102
Canoga Park, CA
91306

3878 Ruffin Road
Suite A
San Diego, CA 92123

COLORADO

1640 South Abilene
Street Suite D
Aurora, CO 80012

FLORIDA

3700 North 29th
Avenue
Suite 102
Hollywood, FL
33020

GEORGIA

8655 Roswell Road
Suite 100
Atlanta, GA 30350

ILLINOIS

9060 Golf Road
Niles, IL 60714

1703 North Randall
Road
Elgin, IL 60123
(Pick-up/Drop-off only)

MARYLAND

62 Mountain Road
Glen Burnie, MD
21061

MASSACHUSETTS

60 Glacier Drive
Suite G
Westwood, MA
02090

MICHIGAN

37048 Van Dyke
Avenue
Sterling Heights, MI
48312

MINNESOTA

7850-12th Avenue
South
Airport Business Center
Bloomington, MN 55425

OHIO

2236 Waycross Road
Civic Center Plaza
Forest Park, OH 45240

PENNSYLVANIA

2221 Cabot Blvd. West
Suite B
Langhorne, PA 19047

TEXAS

13615 Welch Road
Suite 101
Farmers Branch,
TX 75244

WASHINGTON

20425-84th Avenue
South
Kent, WA 98032

HAWAII

99-859 Iwaiwa
Street
Aiea, Hawaii 96701
Phone (808)488-
1996
Fax (808)486-4369

Service in Puerto Rico

Matsushita Electric of Puerto Rico, Inc. Panasonic Sales Company/ Factory Servicenter:

Ave. 65 de Infanteria, Km. 9.5, San Gabriel Industrial Park, Carolina, Puerto Rico 00985
Phone (787)750-4300 Fax (787)768-2910

As of January 2000

Warranty

Panasonic Consumer Electronics Company,
Division of Matsushita Electric Corporation of
America,
One Panasonic Way
Secaucus, New Jersey 07094

Panasonic Sales Company,
Division of Matsushita Electric of Puerto
Rico, Inc.
AVE. 65 de Infanteria, Km. 9.5
San Gabriel Industrial Park
Carolina, Puerto Rico 00985

PANASONIC Video Products Limited Warranty

Panasonic Consumer Electronics Company or Panasonic Sales Company (collectively referred to as "the Warrantor") will repair this product with new or refurbished parts, free of charge, in the USA or Puerto Rico, in the event of a defect in materials or workmanship as follows (all time periods commence from the date of the original purchase):

PRODUCT	PARTS	LABOR
CAMCORDER	ONE (1) YEAR, EXCEPT CCD IMAGE SENSOR CCD IMAGE SENSOR - SIX (6) MONTHS	NINETY (90) DAYS NINETY (90) DAYS
VCR	ONE (1) YEAR	NINETY (90) DAYS
A/V MIXER	ONE (1) YEAR	NINETY (90) DAYS
MONITOR-VCR	ONE (1) YEAR, EXCEPT CRT CRT - TWO (2) YEARS	NINETY (90) DAYS CRT - NINETY (90) DAYS CUSTOMER PAYS ALL LABOR CHARGES AFTER 90 DAYS

Monitor-VCR In-home or carry-in Service: 22" (diagonal) CRT / LCD and Larger
Monitor-VCR Carry-in Service: 21" (diagonal) CRT / LCD and smaller

Batteries (if included) - New rechargeable batteries in exchange for defective rechargeable batteries for ten (10) days. Non-rechargeable batteries are not warranted.

Tape (if included) - New video cassette tape in exchange for a defective video cassette tape for five (5) days.

In-home, carry-in or mail-in service, as applicable, in the USA can be obtained during the warranty period by contacting a Panasonic Services Company (PASC) Factory Servicenter listed in the Service Directory. Or call toll free 1-800-211-PANA (7262), to locate an authorized PASC Servicenter. Carry-in or mail-in service in Puerto Rico can be obtained during the warranty period by calling the Panasonic Sales Company telephone number listed in the Servicenter Directory.

This warranty is extended only to the original purchaser. A purchase receipt or other proof of the date of the original purchase is required before warranty service is rendered.

This warranty only covers failures due to defects in materials and workmanship which occur during normal use and does not cover normal maintenance, including, but not limited to, video and audio head cleaning. The warranty does not cover damage which occurs in shipment, or failures which are caused by products not supplied by the warrantor, or failures which result from accident, misuse, abuse, neglect, mishandling, misapplication, alteration, modification, faulty installation, set-up adjustments, improper antenna, inadequate signal pickup, maladjustment of consumer controls, improper operation, power line surge, improper voltage supply, lightning damage, commercial use such as hotel, office, restaurant, or other business or rental use of the product, or service by anyone other than a PASC Factory Servicenter or a PASC authorized Servicenter, or damage that is attributable to acts of God.

LIMITS AND EXCLUSIONS

There are no express warranties except as listed above.

THE WARRANTOR SHALL NOT BE LIABLE FOR INCIDENTAL OR CONSEQUENTIAL DAMAGES (INCLUDING, WITHOUT LIMITATION, DAMAGE TO TAPES) RESULTING FROM THE USE OF THIS PRODUCTS, OR ARISING OUT OF ANY BREACH OF THE WARRANTY. ALL EXPRESS AND IMPLIED WARRANTIES, INCLUDING THE WARRANTIES OF MERCHANTABILITY AND FITNESS FOR PARTICULAR PURPOSE, ARE LIMITED TO THE APPLICABLE WARRANTY PERIOD SET FORTH ABOVE. Some states do not allow the exclusion or limitation of incidental or consequential damages, or limitations on how long an implied warranty lasts, so the above exclusions or limitations may not apply to you.

This warranty gives you specific legal rights and you may also have other rights which vary from state to state.

If a problem with this product develops during or after the warranty period, you may contact your dealer or Servicenter. If the problem is not handled to your satisfaction, then write to the Customer Satisfaction Center at the Panasonic Consumer Electronics Company address above.

SERVICE CALLS WHICH DO NOT INVOLVE DEFECTIVE MATERIALS OR WORKMANSHIP AS DETERMINED BY THE WARRANTOR, IN ITS SOLE DISCRETION, ARE NOT COVERED. COSTS OF SUCH SERVICE CALLS ARE THE RESPONSIBILITY OF THE PURCHASER.

warvid 10/20/99

Download from www.Somanuals.com. All Manuals Search And Download.

Como realizar la Configuración Inicial

1 Encienda el TV y ajústelo en el canal 3.

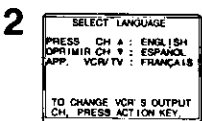

Encienda el VCR. Al encender el VCR por primera vez, en la pantalla aparecerá SELECT LANGUAGE.

- Si la pantalla no aparece, verifique las conexiones entre el VCR y el TV, y si el TV está sintonizado en el canal 3, intente cambiándolo al canal 4.
- Cuando desee cambiar el canal de salida del VCR, por favor remítase Canal de Salida del VCR en la página 11.
- Si ajusta el idioma equivocado, realice los pasos de "Reajuste de Todas las Funciones de Memoria del VCR" en la página 9.



Pulse CH ▲ para seleccionar Inglés.

○
Pulse CH ▼ para seleccionar Español.

○
Pulse la tecla VCR/TV para seleccionar Francés. Cuando se pulsa una de las teclas anteriores, aparece la pantalla FIJACION AUTO. (CA/RELOJ).

Encienda la caja de cable y ajuste su canal de Estación Pública de Radiodifusión (PBS) en su huso horario. Si utiliza un receptor DSS, este tiene que estar apagado.

Ajuste Manual del Reloj

Si el ajuste automático del reloj no se ha completado, ajuste el reloj manualmente de la siguiente manera:

- 1) Pulse la tecla ACTION en el control remoto para visualizar la pantalla del menú RELOJ.
- 2) Pulse ▲▼ para seleccionar el mes y ► para ajustar. De la misma forma, seleccione y ajuste la fecha, año, hora y DST (Hora de Verano).
- 3) Pulse dos veces la tecla ACTION para poner el RELOJ en marcha y salir.

Ajustar de nuevo el reloj

1 Pulse ACTION para exhiba el menú.



Pulse ◀▶ para seleccionar "RELOJ".



Pulse ▲▼ para seleccionar "MANUAL" y luego pulse ►.



Pulse ▲▼ y ◀▶ para seleccionar y ajustar la hora y la fecha.

5 Pulse ACTION dos veces para que el reloj comience a funcionar y salir desde este modo.



Pulse la tecla CH ▲ para comenzar la operación de Ajuste Automático Canal/Reloj. El ajuste Canal/Reloj se lleva a cabo automáticamente. Si la configuración se termina, aparece la pantalla siguiente.

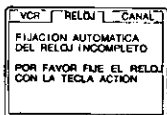

Si aparece la pantalla "Fijacion Automatica Del Reloj Incompleto", ajuste el reloj utilizando los procedimientos de "AJUSTE MANUAL DEL RELOJ".

Operaciones básicas para la reproducción

- 1 **Inserte una cinta,**
 - la alimentación del VCR se activa. En la Pantalla de Visualización Multi Función se ilumina "VCR".
- 2 **Pulse PLAY** para reproducir la cinta.
 - Si la cinta no tiene lengüeta de prevención de grabación (página 4), se inicia la reproducción automática.

Detalles especiales durante la grabación

- **Pulse FF o REW** para búsqueda de escenas hacia delante/ Hacia atrás. **Pulse nuevamente o pulse PLAY** para liberar.
- **Pulse PAUSE/SLOW** para imagen Fija (Congelada). **Pulse PLAY** para liberar.
- **Pulse PAUSE/SLOW** en el modo de Imagen fija para imágenes Cuadro a Cuadro. **Pulse PLAY** para liberar.
- **Mantenga pulsado PAUSE/SLOW** en el modo de imagen fija para imágenes en cámara lenta. **Pulse PLAY** para liberar.

- 3 **Pulse STOP** para detener la cinta.
 - **Pulse REW o FF** en el modo de parada para Rebobinado/Avance Rápido de la cinta.
 - **Pulse EJECT** en el control remoto, o **STOP/ EJECT** en el VCR para expulsar la cinta.

Operaciones básicas para la grabación

- 1 **Inserte la cinta con lengüeta de protección de grabación (pág. 4).**
 - La alimentación del VCR se activa. En la pantalla Multi Función se ilumina "VCR".
- 2 **Pulse CH ▲▼, o las teclas de números** para seleccionar el canal.
- 3 **Pulse SPEED** para seleccionar la velocidad de grabación (pág.4)
 - SP = Reproducción estándar,
 - LP = Larga duración,
 - SLP = Superlarga duración.
- 4 **Pulse REC** para comenzar a grabar.
 - Para eliminar escenas indeseadas, pulse **PAUSE/SLOW** para pausar, y al pulsar nuevamente se reanuda la grabación.
- 5 **Pulse STOP** para detener la grabación.
 - **Grabación de Un Toque** (grabar en marcha),
 - El VCR se apaga después de preajustar la extensión de la grabación:

--> Cada vez que se pulsa REC se adicionan 30 min. a la extensión de grabación hasta un máximo de 4 horas.

Programación fácil para la grabación con temporizador



Pulse PROG para visualizar la pantalla de Programa.

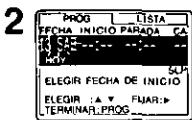

- 1) Para ajustar la **FECHA** de grabación, pulse **▲▼** para seleccionar:
 - 1-31 = una vez, o **DIARIO** = a la misma hora de lunes a viernes, o **SEMANA** = a la misma hora cada semana y pulse **▶** para ajustar.
 - Vea el orden de selección abajo a la izquierda.

Ejemplo

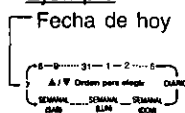

- 2) Para ajustar los ítems que quedan, pulse **▲▼** para seleccionar y pulse **▶** para ajustar los tiempos de **START/STOP**, **CANAL**, o entrada de **LÍNEA** (pág. 20), y velocidad de la cinta (**SP**, **LP**, **SLP**).

Pulse PROG para finalizar el programa.

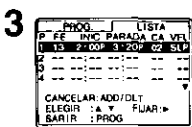

- 3) **Pulse ▲▼** para seleccionar un número sin usar para ingresar mas programas y pulse **▶** para ajustar. Luego repita el paso 2.

Pulse nuevamente PROG para salir.

- 4) **Pulse POWER off** para ajustar el temporizador.
(Se ilumina "TIMER" en el panel delantero)

Index

Accessories	4	Record	13
AC Power Plug	7	Record Button	6
Add or Delete a Channel	11	Remote Control Buttons	6
Audio Input Connector(L/R)	7	Remote Sensor	6
Audio Output Connector(L/R)	7	Remote Warning ON/OFF	22
Auto Operation Functions	21	Repeat Play	22
Auto Shut-Off	23	Review, Replace or Clear Program Contents	15
Before Requesting Service	27	Rewind/Search Button	6
Blank Tape/ No Video Signal Indication	26	Select Audio Mode	19
Cable Box Setup	8	Service Center List	28
Cassete Compartment	6	Spanish Quick Use Guide	30,31
Channel Up/Down Tracking/ V-Lock Button	6	Specifications	25
Cleaning the VCR	25	Stereo/SAP/Mono Broadcast	18
Commercial Skip	21	Stop/Eject Button	6
Connections	8, 17	Tape Position Display	22
Copying Your Tapes	24	Timer Indicator	7
DST (Daylight Saving Time)	11	Timer Recording	14
Fast Forward/Search Button	6	VCR Indicator	7
Features for a Quality Picture	25	VCR Lock	23
Function & Channel Display	26	VCR Status & Clock Display	26
Head Cleaning	25	VCR/TV Selector	6
Index Search	20	VHF/UHF Antenna Input Terminal	7
Initial Setup	8,9	VHF/UHF Antenna Output Terminal	7
MTS Broadcast	18	Video Input Connector(L/R)	7
Multi-Brand Control	16	Video Output Connector(L/R)	7
On-Screen Display	26	Warning and Instruction Displays	26
Playback	12	Warranty	29
Play Button	6	Weak Signal Display ON/OFF	23
Power Button	6	Zero Search	22
Power Indicator	7		
Program End Search	20		

Panasonic Consumer Electronics
Company, Division of Matsushita
Electric Corporation of America
One Panasonic Way Secaucus,
New Jersey 07094

Panasonic Sales Company ("PSC"),
Division of Matsushita Electric of Puerto Rico, Inc.
Ave. 65 de Infantería, Km. 9.5
San Gabriel Industrial Park, Carolina,
Puerto Rico 00985

Printed in Indonesia
LSQT0330A
S1100-0



Free Manuals Download Website

<http://myh66.com>

<http://usermanuals.us>

<http://www.somanuals.com>

<http://www.4manuals.cc>

<http://www.manual-lib.com>

<http://www.404manual.com>

<http://www.luxmanual.com>

<http://aubethermostatmanual.com>

Golf course search by state

<http://golfingnear.com>

Email search by domain

<http://emailbydomain.com>

Auto manuals search

<http://auto.somanuals.com>

TV manuals search

<http://tv.somanuals.com>