

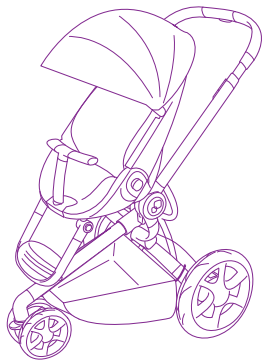

Instructions for use
& Warranty



MOODD

Legend / Moodd

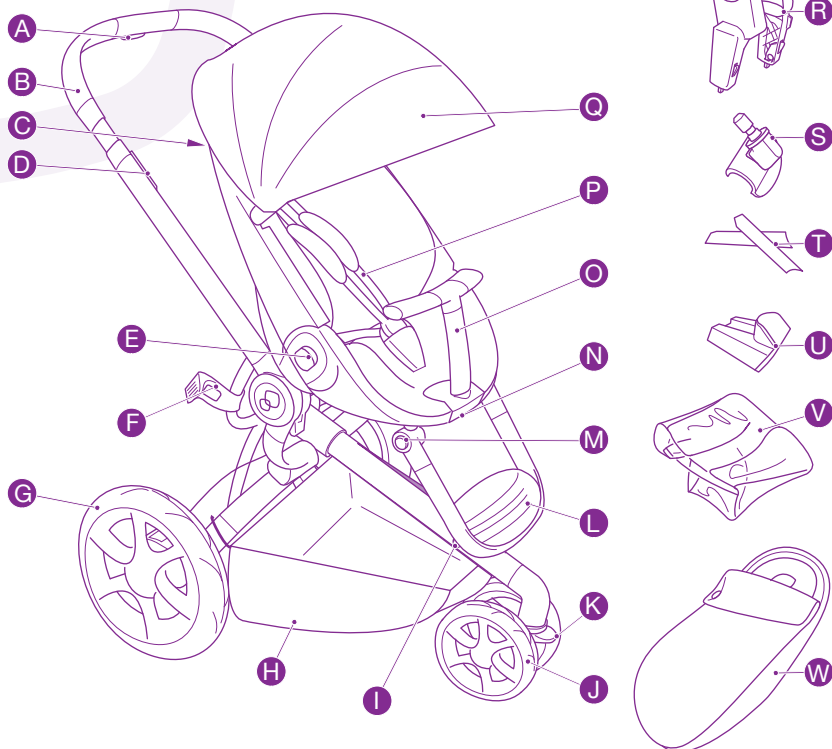

- A. Handlebar adjustment button
- B. Handlebar
- C. Seat adjustment button
- D. Lock button for folding
- E. Seat release button
- F. Transport lock
- G. Rear wheel
- H. Shopping basket
- I. Front wheel module release button
- J. Front wheel
- K. Swivel wheel lock
- L. Footrest
- M. Footrest adjustment button
- N. Safety bar release button
- O. Safety bar
- P. Harness
- Q. Canopy
- R. Adapters
- S. Parasol clip
- T. Replacement part canopy
- U. Replacement part safety bar
- V. Raincover
- W. Baby cocoon

Legend	2
Use	5
Safety, warranty, general information	34

Use

Preparation	5
Folding	10
Unfolding	11
Seat	12
Footrest	13
Harness	14
Wheels	17
Canopy	19
Adapters	21
Safety bar	22
Fabric	23
Raincover	25
Parasol clip	27
Baby cocoon	29
Brake adjustment	30
Dimensions	31
Accessories	32

Preparation

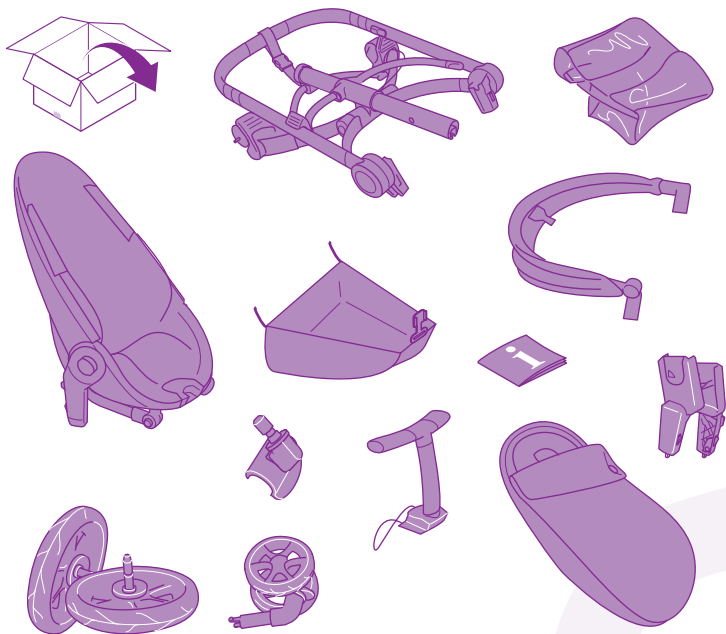

Preparation

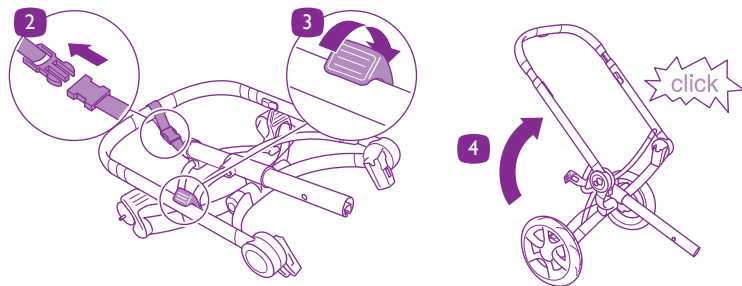
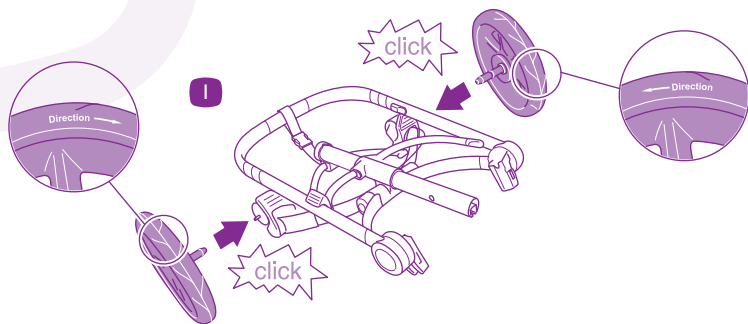

Preparation

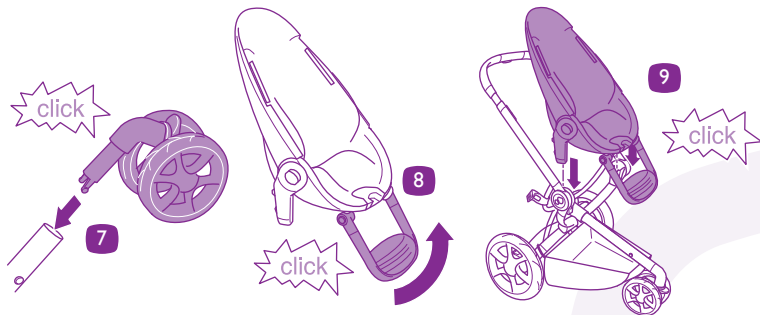
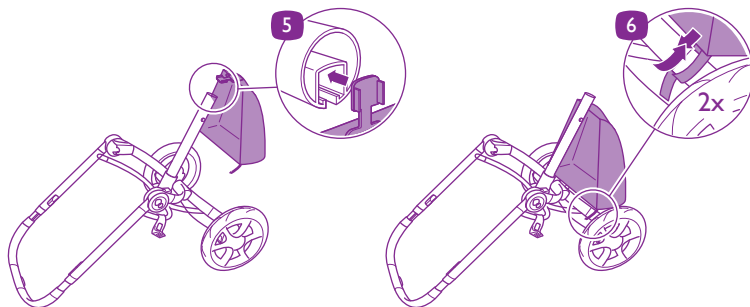

Preparation

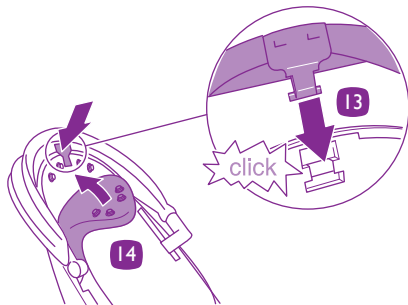
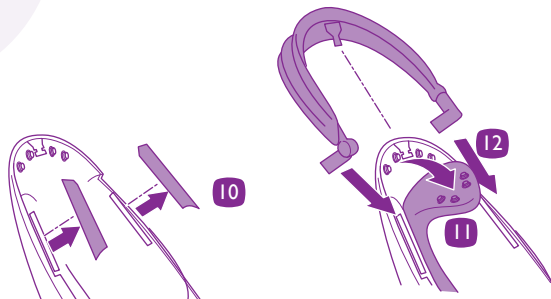

Preparation

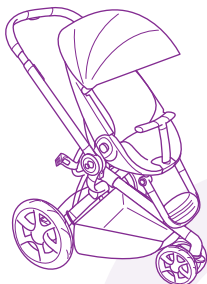
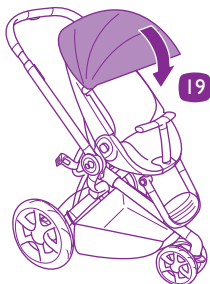
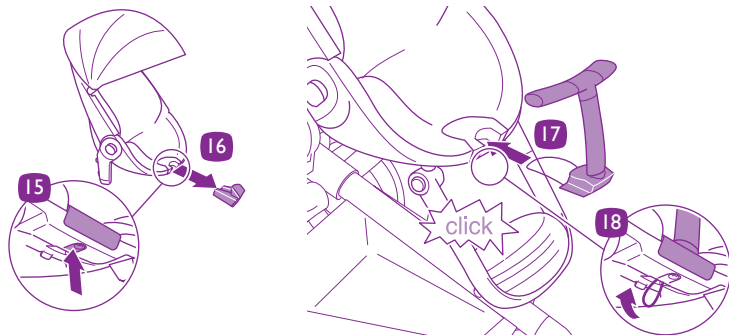

Pushchair / Folding

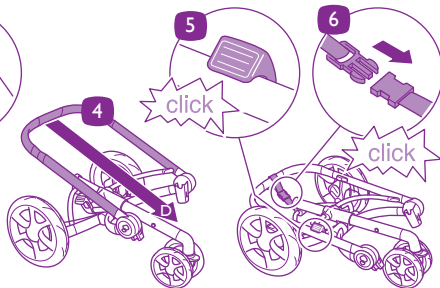
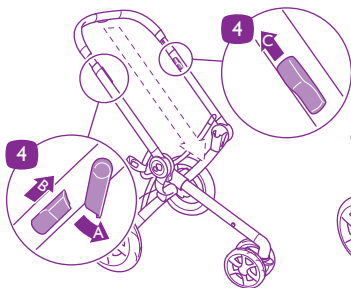
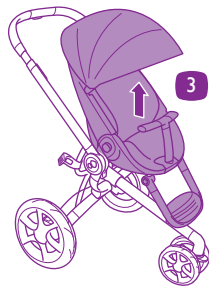
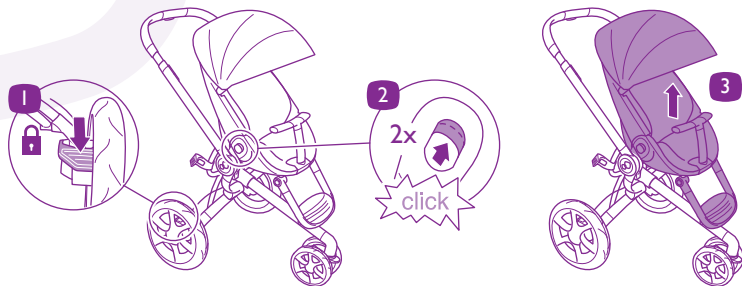

Pushchair / Unfolding

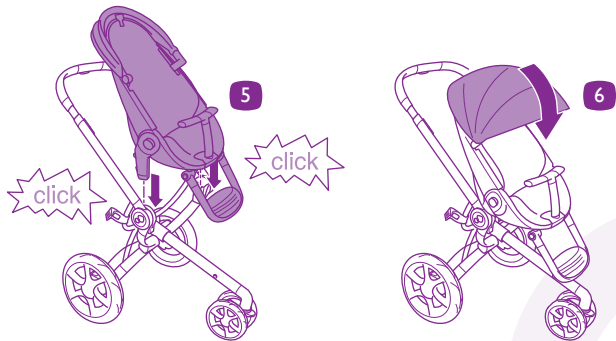
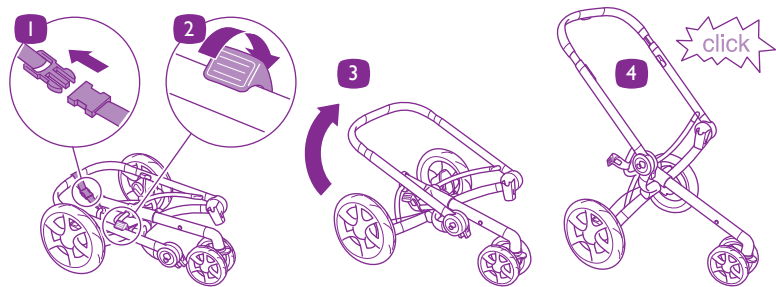

Seat / Rearward / Forward facing

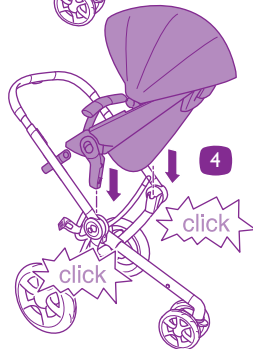
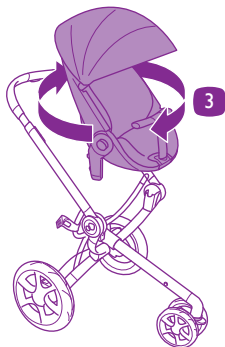
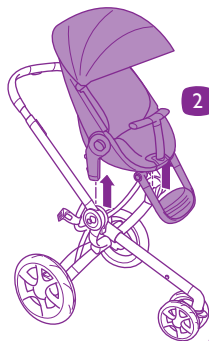
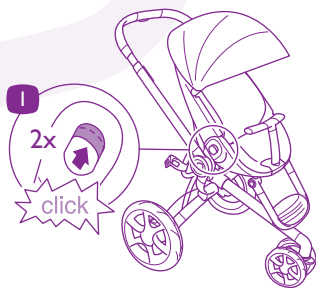

Seat / Recline

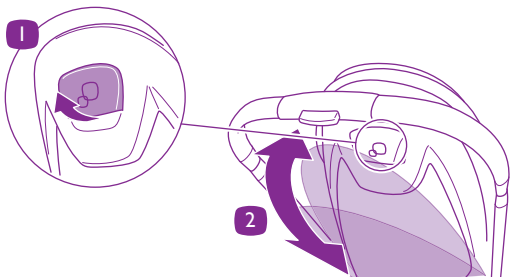

Footrest / Use

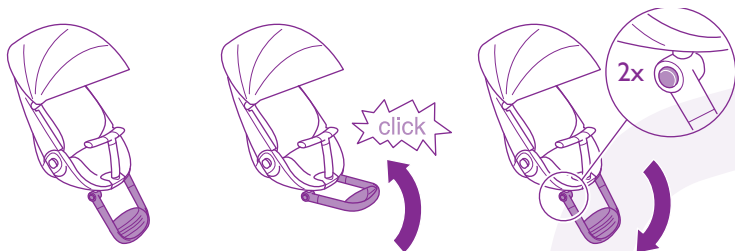

Harness / Closing - Opening

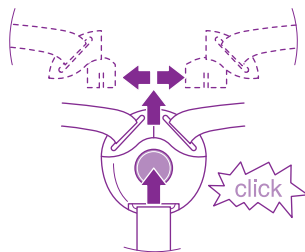
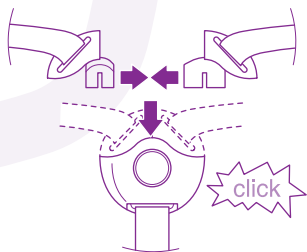

Harness / Length

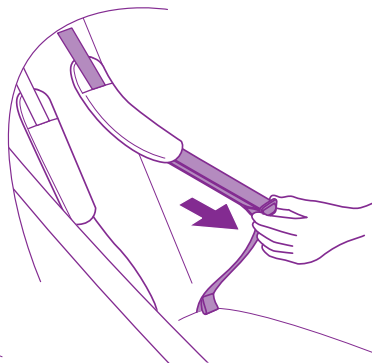
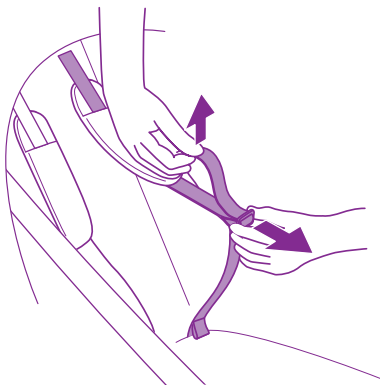

Harness / Height

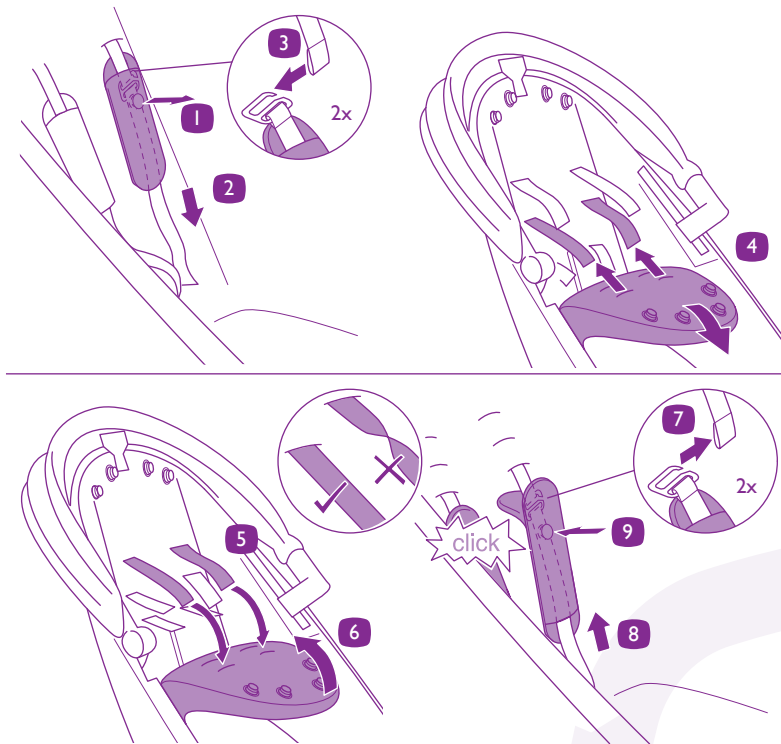

Harness / From birth use

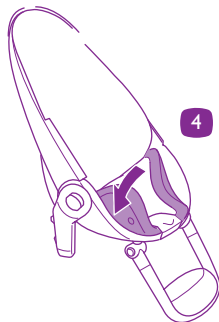
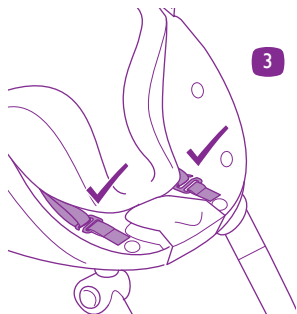
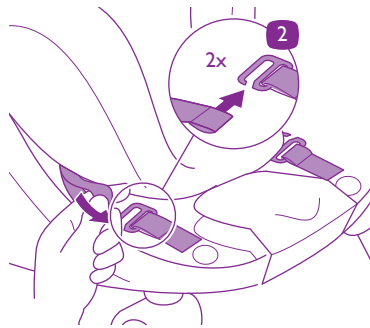
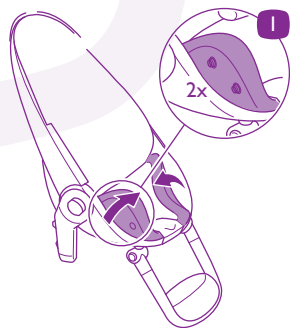

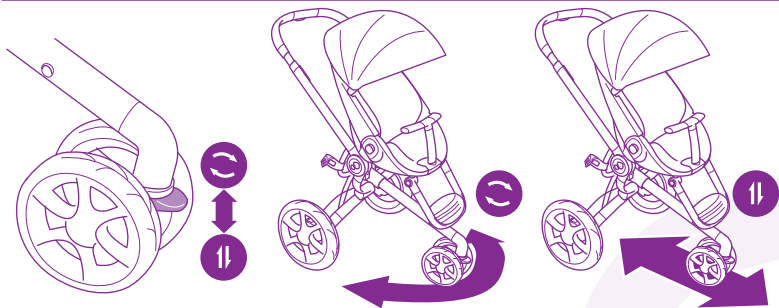
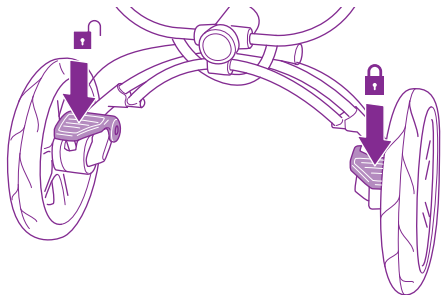

Wheels / Use

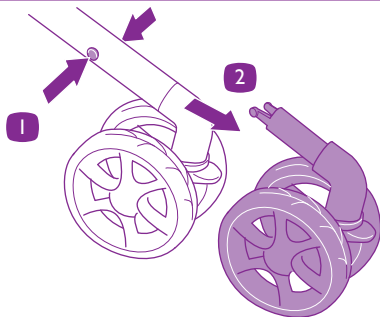
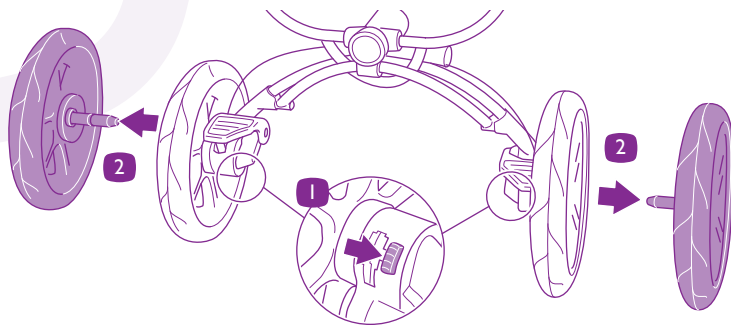

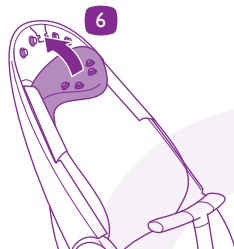
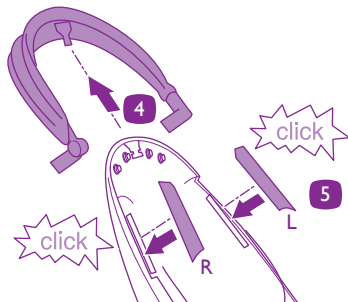
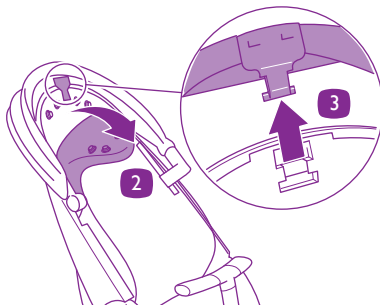
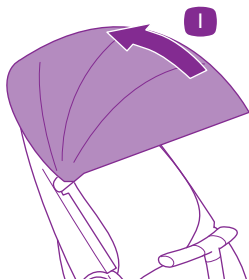

Canopy / Use

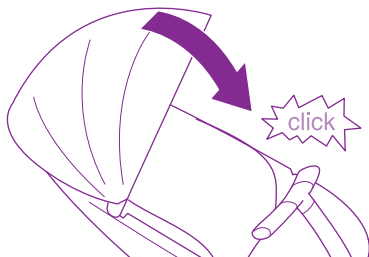
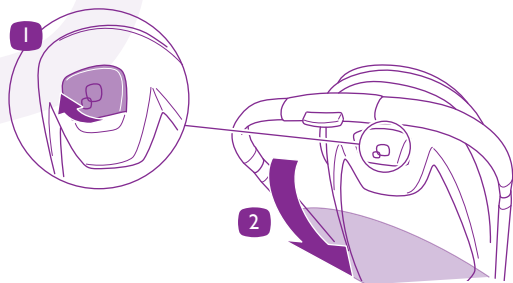

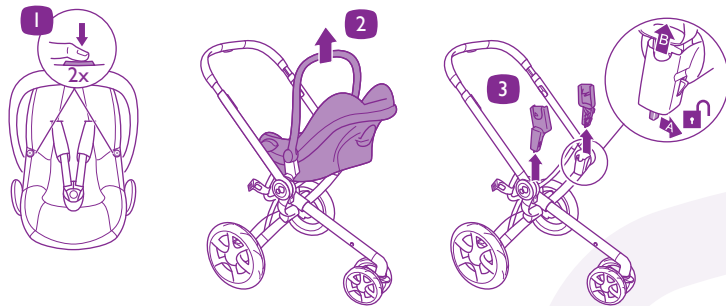
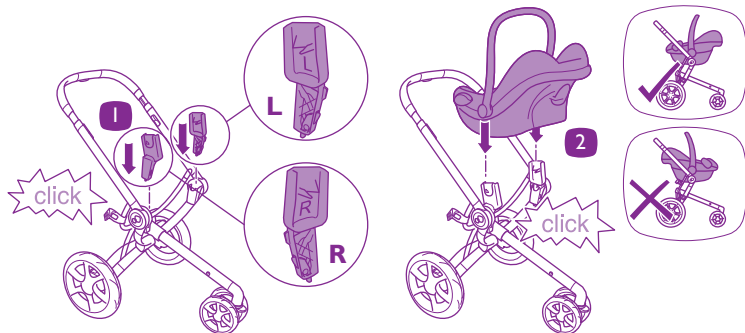

Safety bar / Use

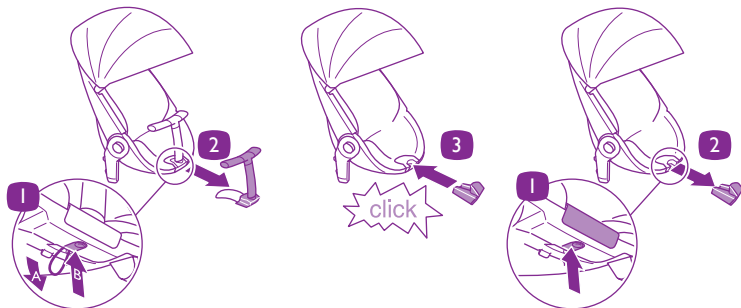
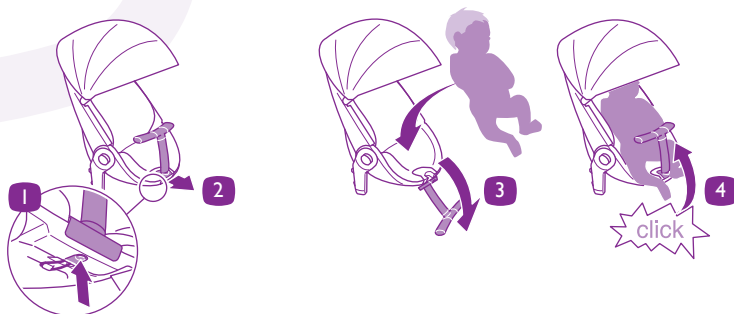

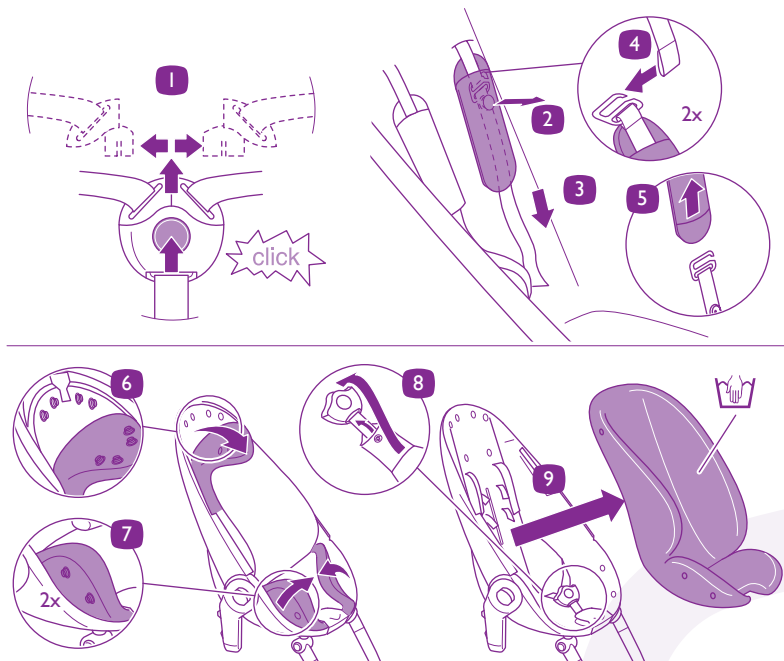

Fabric / To fit

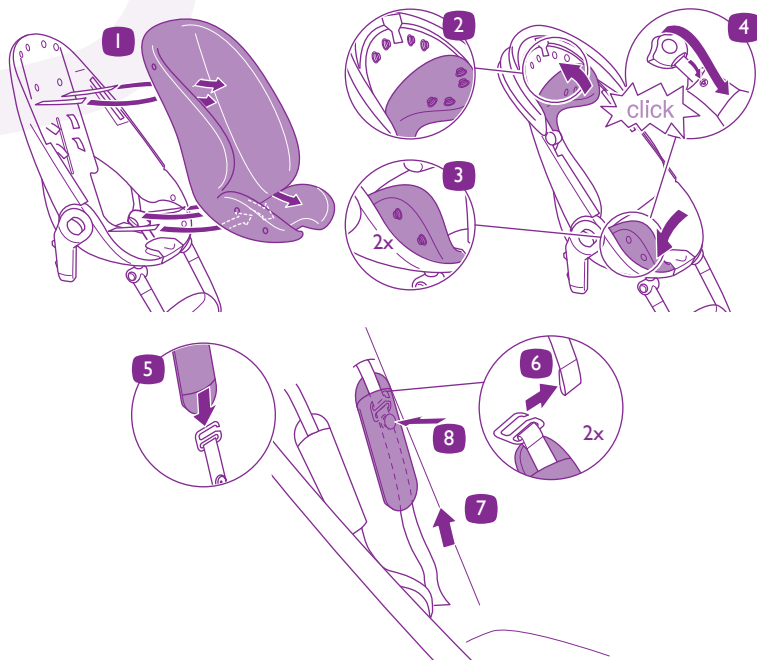

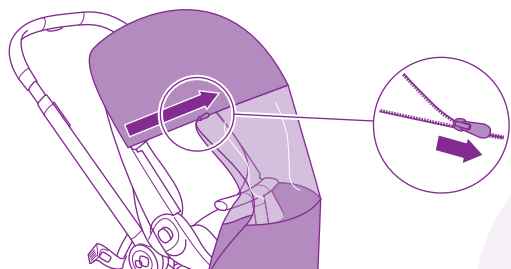
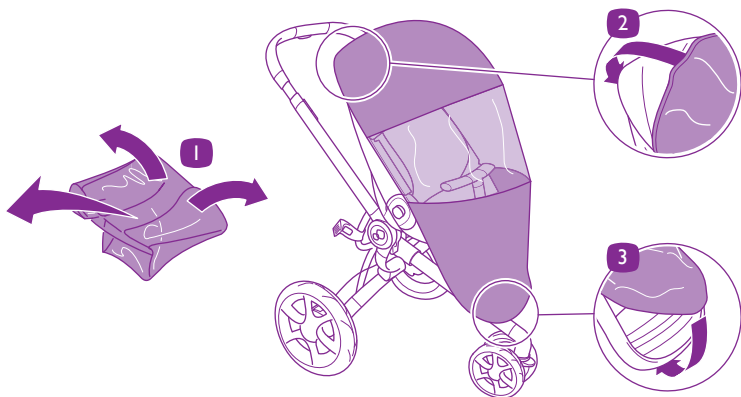

Parasol clip / Use

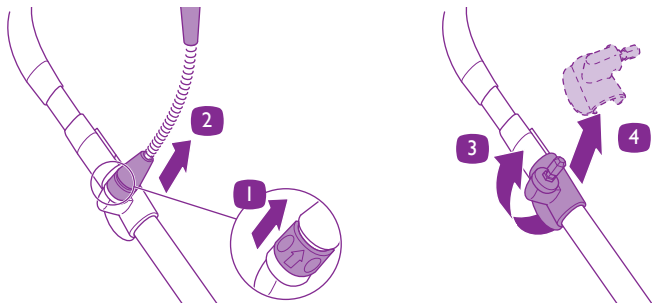
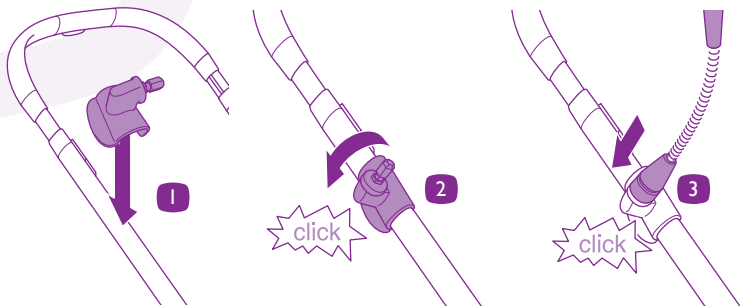

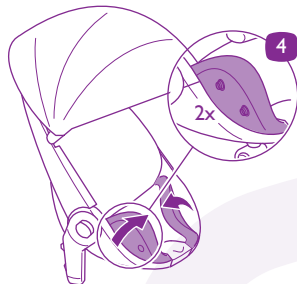
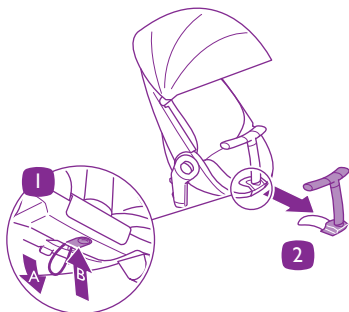
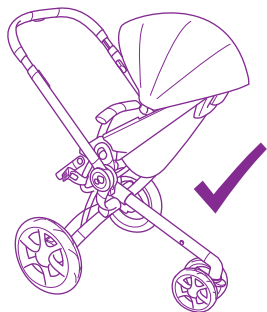

Baby cocoon / Use

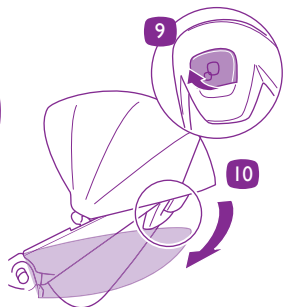
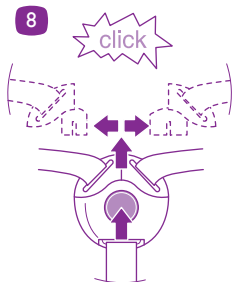
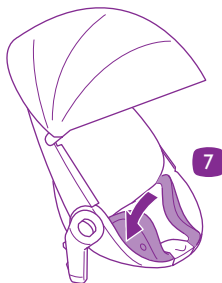
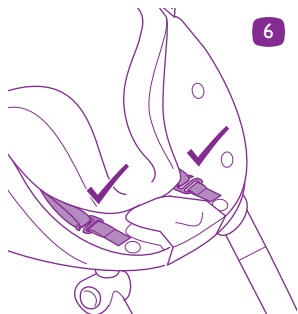
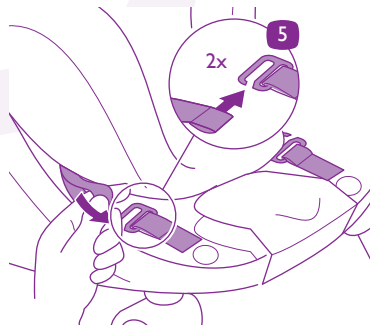

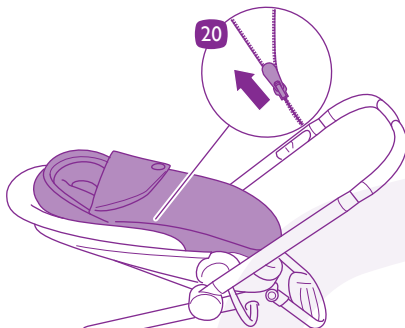
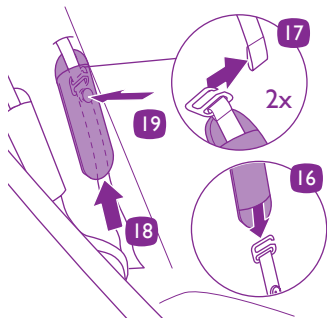
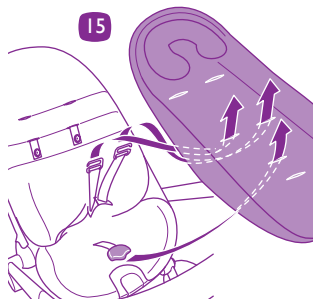
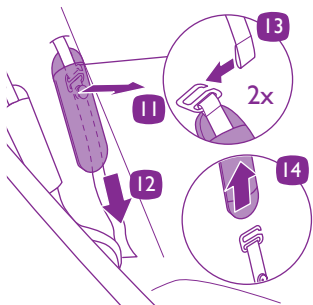

Maintenance / Brake adjustment

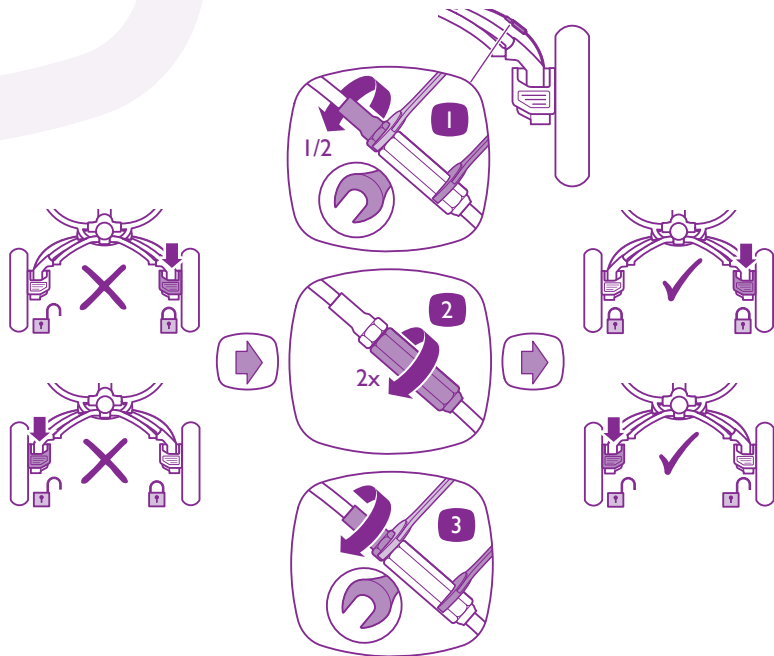

Dimensions / Weight

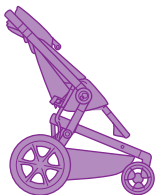

15,1 kg

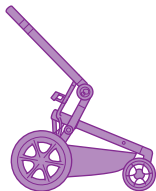

9,4 kg

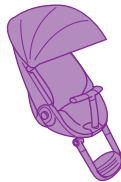

5,7 kg

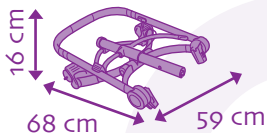
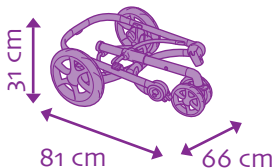
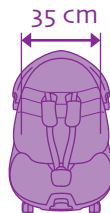
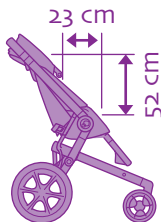
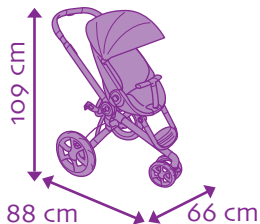

Accessories / Exclusive (Optional)

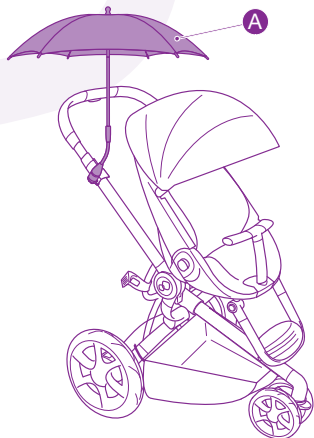

- A. Parasol
- B. Footmuff
- C. Front wheel unit
- D. Foldable carrycot
- E. Safety carrycot

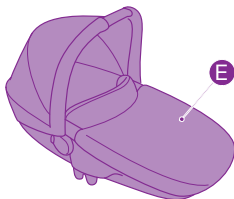
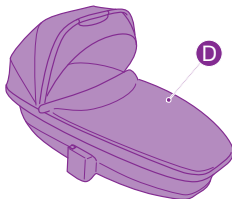
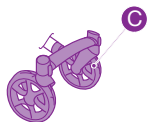
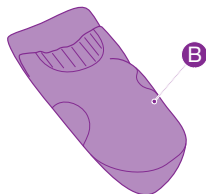

Safety and Maintenance

- WARNING:** Read these instructions carefully before use and keep them for future reference. Your child's safety may be affected if you do not follow these instructions.
- WARNING:** A CHILD'S SAFETY IS YOUR RESPONSIBILITY.
- WARNING:** Not suitable for overnight sleeping, your child may be at risk of serious harm or injury.
- WARNING:** Always activate the parking brake on the pushchair when standing still.
- WARNING:** It may be dangerous to leave your child unattended.
- WARNING:** Always use the harness provided with the item. Rings for attaching an extra harness are on each side, beside the seat belt.
- WARNING:** Always use the crotch strap in combination with the waist belt.
- WARNING:** Check that the pram body or seat unit attachment devices are correctly engaged before use.
- WARNING:** Ensure that all locking devices are engaged before use.
- WARNING:** Any load attached to the handle affects the stability of the pram/ pushchair.
- WARNING:** This product is not suitable for running or skating.
- WARNING:** To avoid the risk of suffocation, keep all plastic bags and packaging out of reach of babies and young children.
- WARNING:** Check regularly to make sure that the Quinny Moodd functions properly. This is essential for your child's safety.
- WARNING:** The tyres may leave black marks on some surfaces (particularly smooth floors like parquet, laminate and linoleum).

SAFETY INSTRUCTIONS

- Use the Quinny Moodd for only one child at a time.
- The Quinny Moodd is suitable for children from birth and up, weighing up to 15 kg (approx. 3.5 years).
- Keep your child and hands away from moving/ folding parts when folding, unfolding or adjusting the Quinny Moodd.
- Never lift the Quinny Moodd when your child is sitting or lying in it. Do not use escalators or stairs when your child is in the Quinny Moodd.
- Do not remove the logos from the fabric cover or frame, as this could cause damage to these components.
- Only use original accessories and parts that have been approved by the manufacturer. Do not make any modifications to the product.
- The Quinny Moodd has been approved in accordance with EN1888:2003 (amendments 1, 2 & 3).

CLEANING AND MAINTENANCE

- Maintain and clean the Quinny Moodd frequently.
- Take care while cleaning the Quinny Moodd. Clean the frame and plastic parts of the pushchair with a damp cloth and mild detergent and dry thoroughly. Don't use abrasive cleaners on either the plastic section or the frame or bleach near the fabric covers otherwise this may cause discoloration or scratches.
- When it is raining, always use the raincover to protect the fabric cover.
- After using in the rain, wipe the pushchair with a soft, absorbent cloth.
- Remove the detachable wheels once a month. Clean the axles and treat them with a dry Teflon spray. Never use Vaseline, grease or silicon lubricants.
- Inflate the rear tyres to a maximum pressure of 26 psi / 1.8 bar. The tyres are fitted with a 'car tyre valve'. They can be inflated using the pump supplied (in shopping bag). The valves on the rear wheels can be easily accessed from the inside of the wheel.
- A punctured inner tube can be repaired in the same way as a bicycle tyre. Spare inner tubes can be purchased through your supplier.
- Always deflate the tyres when taking the Moodd on an aircraft, as the air pressure difference could cause the tyres to burst.
- The brakes may require periodic adjustment. To do this, use two 8 mm spanners to unlock the lock nut from the long barrel nut. Adjust the brake cable and retighten the lock nut. Test the brakes to ensure a positive engagement and disengagement after adjustment.

WASTE SEPARATION

To help protect the environment, we kindly ask you to separate the packaging waste from the Quinny Moodd and at the end of its useful life to separate the components and dispose it properly.

Warranty and Contact

WARRANTY

We guarantee that this product was manufactured in accordance with the current European safety requirements and quality standards which are applicable to this product, and that this product is free from defects in workmanship and material at the time of purchase. During the production process the product was subjected to various quality checks. If this product, despite our efforts, shows a material/manufacturing fault within the warranty period of 24 months (with normal use as described in the user instructions) we will comply with the warranty terms and conditions. In this case please contact your dealer. For extensive information on applying the warranty terms and conditions, you can contact the dealer or visit our website: www.quinny.com.

The warranty is not valid in the following cases:

- In case of a use or purpose other than described in the manual.
- If the product is submitted for repair through a dealer that is not authorized by us.
- If the product is not supplied to the manufacturer with the original purchase receipt (via the retailer and/or importer).
- If repairs were carried out by third parties or a dealer that is not authorized by us.
- If the defect is the result of improper or careless use or maintenance, negligence or impact damage to the fabric cover and/or frame.
- If the parts show normal wear and tear that may be expected from daily use of a product (wheels, rotating and moving parts etc.)

Date of effect:

- The warranty becomes effective on the date the product is purchased.

Warranty term:

- The warranty period applies for a period of 24 consecutive months. The warranty only applies for the first owner and is not transferable.

What to do in case of defects:

- After purchasing the product, keep the purchase receipt. The date of purchase must be clearly visible on the receipt. Should problems or defects arise please contact your retailer. Exchanging or taking back the product cannot be requested. Repairs do not give entitlement to extension of the warranty. Products that are returned directly to the manufacturer are not eligible for warranty.
- This Warranty Clause conforms to European Directive 99/44/EG of 25 May 1999.

QUESTIONS

Should you have any questions, please contact your supplier or importer (see www.quinny.com).

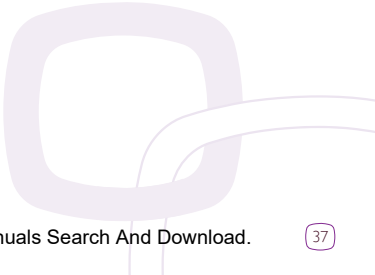



Free Manuals Download Website

<http://myh66.com>

<http://usermanuals.us>

<http://www.somanuals.com>

<http://www.4manuals.cc>

<http://www.manual-lib.com>

<http://www.404manual.com>

<http://www.luxmanual.com>

<http://aubethermostatmanual.com>

Golf course search by state

<http://golfingnear.com>

Email search by domain

<http://emailbydomain.com>

Auto manuals search

<http://auto.somanuals.com>

TV manuals search

<http://tv.somanuals.com>