

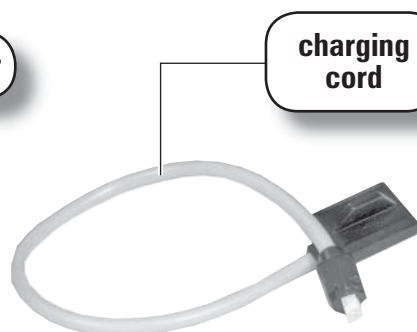
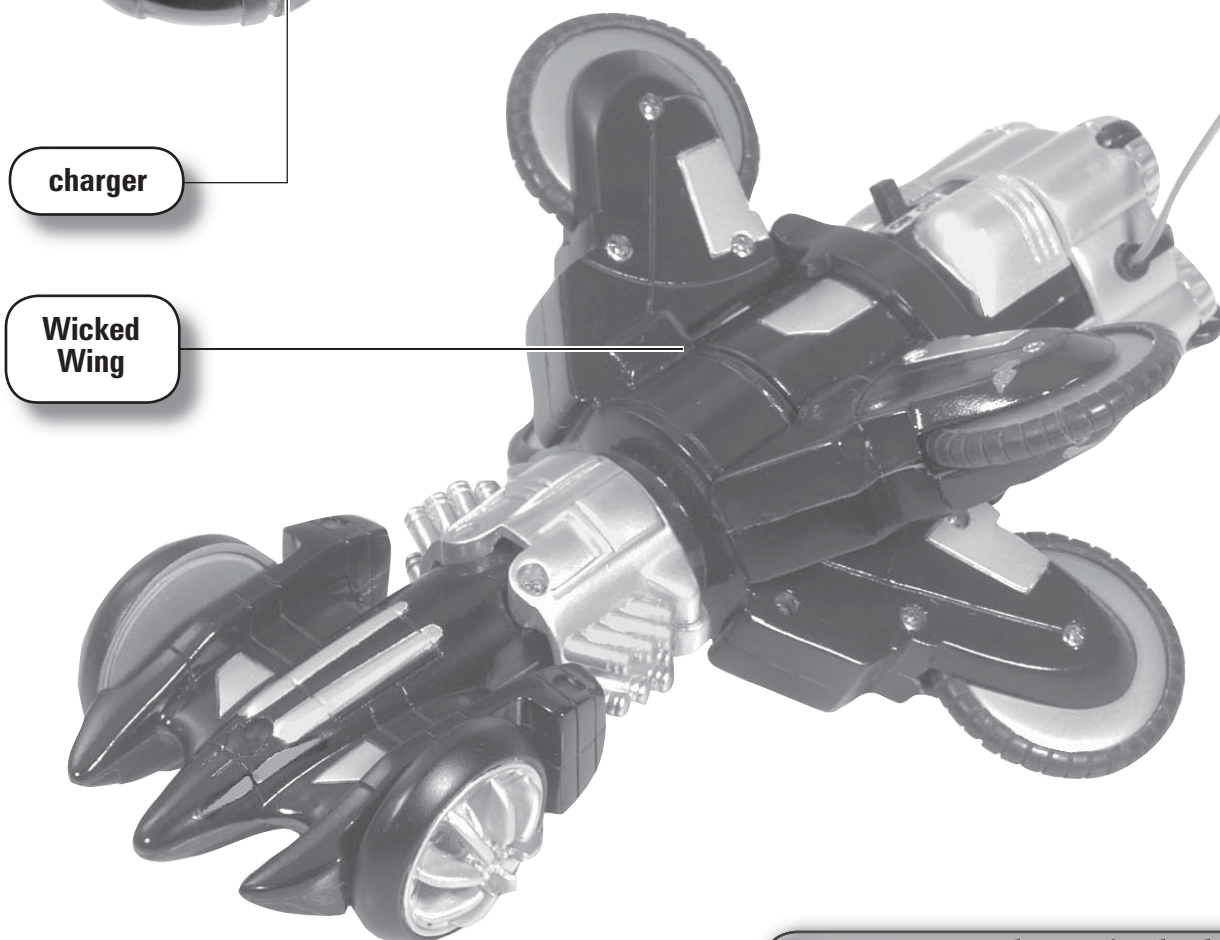

60-4395

wicked wing

Thank you for purchasing your Micro Wicked Wing from RadioShack. This tiny vehicle will dazzle your friends because of all the cool stunts it can do. The Wicked Wing is available in two frequencies (27 and 49 MHz) so that you can race other radio-controlled vehicles.

**charger****transmitter****charging cord****Wicked Wing**

Note: Actual product may vary from the images found in this document. Images not to scale.

what's included

Wicked Wing
charger

transmitter
charging cord
user's guide

installing batteries

To power your Wicked Wing, you will need one 9V battery for the transmitter and six AA batteries for the charger. None are supplied, but all are available at your local RadioShack or online at www.radioshack.com.

in the transmitter

1. Remove the cover. Replace when finished.

2. Place the 9 volt battery in the compartment as indicated by the polarity symbols (+ and -).

NOTE

When the transmitter's range decreases, replace its battery.

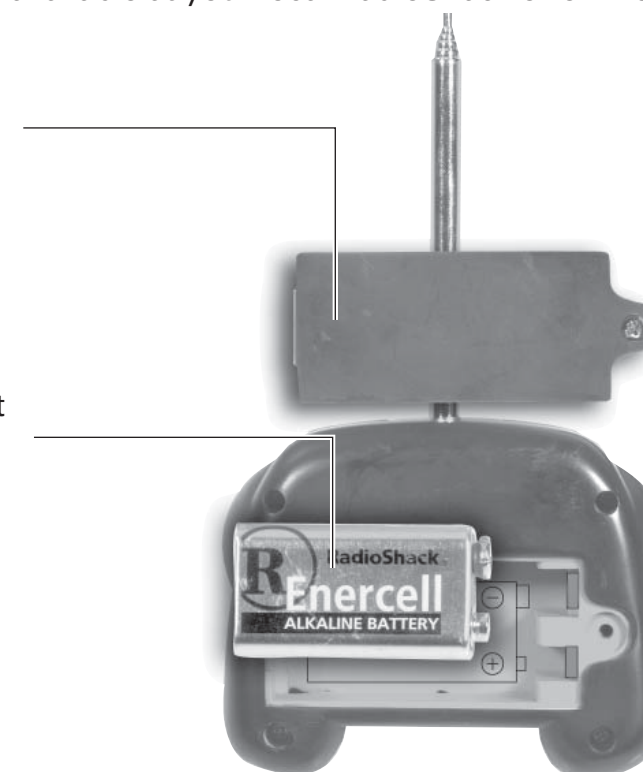
**in the charger**

1. Remove the battery compartment cover. Replace when finished.

2. Install six AA batteries into charger's battery compartment as indicated by the polarity symbols (+ and -).

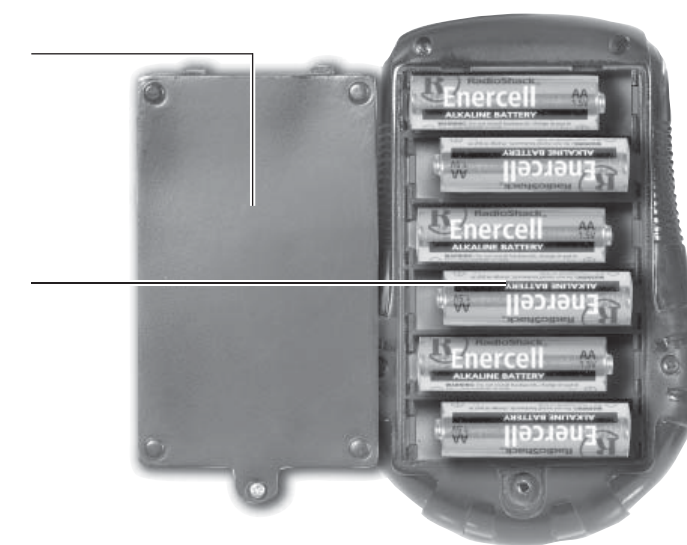
**installing batteries**

- Dispose of old batteries promptly and properly. Do not burn or bury batteries.
- Use only fresh batteries of the required size and recommended type.
- Do not mix old and new batteries, different types of batteries (standard, alkaline, or rechargeable), or rechargeable batteries of different capacities.
- If you do not plan to use the toy for several days, remove the batteries. Batteries can leak chemicals that can damage electronic parts.
- Batteries purchased for use in this toy may pose a hazard to children. Please check the safety notice supplied with batteries before use.

charging your Wicked Wing

1. Turn off the vehicle and plug it into the charger via the charging cord as indicated.

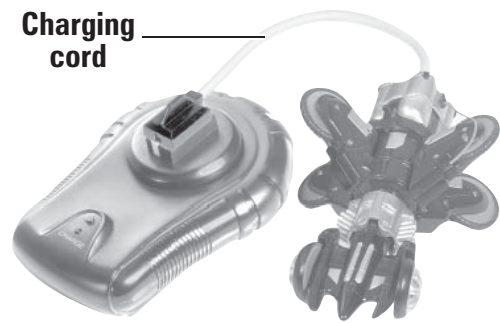

2. Press the charging button and make sure the LED indicator lights up red, indicating it is charging.



3. Unplug the vehicle when the LED turns off, indicating charging is complete.

NOTE Charge time is about 5 minutes.
Run time of the vehicle is about 5 minutes between charges.
Never recharge your vehicle without completely discharging it first. This can damage the Wicked Wing.

driving your Wicked Wing

getting started

1. Fully extend the transmitter's antenna.
2. Slide the ON/OFF switch on the transmitter and Wicked Wing to ON.
3. Use the controls on the transmitter to drive the Wicked Wing.

using your controls

1. Press A to move forward.
2. Press B to move backward.
3. Press C to rotate counter clockwise (⤴).
4. Press D to rotate clockwise (⤵).
5. Press A and C together to drive forward in a counter clockwise circle.
6. Press A and D together to drive forward in a clockwise circle.
7. Press B and C together to drive backward in a counter clockwise circle.
8. Press B and D together to drive backward in a clockwise circle.
9. Use the E and F buttons to make the wheel holders open and close.

NOTE Try your own combination of buttons and invent your own stunts!
If the "turn" direction of the vehicle is opposite the transmitter, you can rotate the wing body to use another pair of the rear wheels.

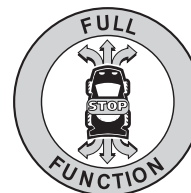

ON/OFF Switch

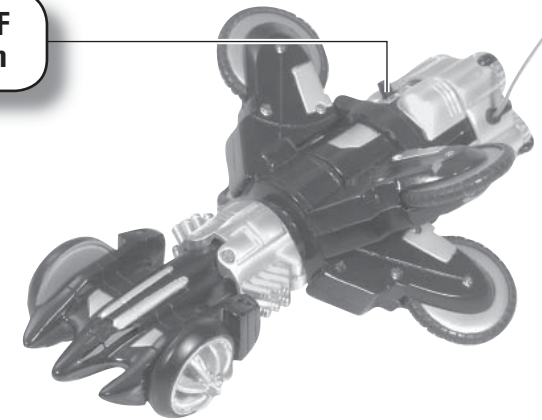

Antenna

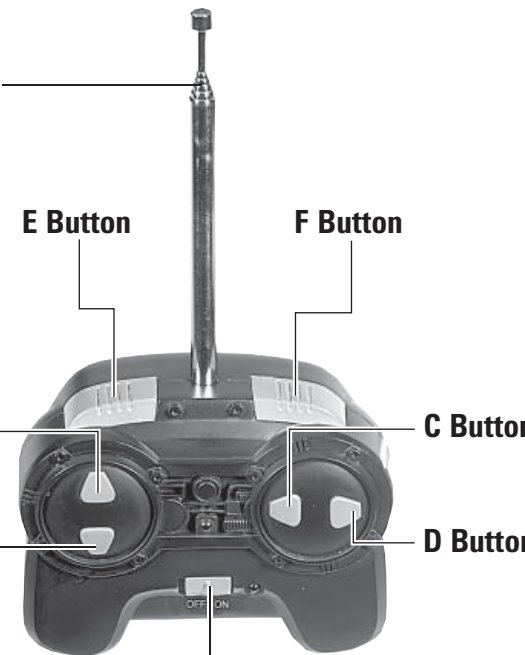

A Button

B Button

E Button

F Button

C Button

D Button

ON/OFF Switch

recycle your batteries

The EPA certified RBRC® Battery Recycling Seal on the nickel-cadmium (Ni-Cd) battery indicates RadioShack is voluntarily participating in an industry program to collect and recycle these batteries at the end of their useful life, when taken out of service in the United States or Canada. The RBRC program provides a convenient alternative to placing used Ni-Cd batteries into the trash or the municipal waste stream, which may be illegal in your area. Please call 1-800-THE-SHACK (1-800-843-7422) for information on Ni-Cd battery recycling and disposal bans/restrictions in your area. RadioShack's involvement in this program is part of the company's commitment to preserving our environment and conserving our natural resources.



the FCC wants you to know

This equipment has been tested and found to comply with the limits for a Class B digital device, pursuant to Part 15 of the FCC Rules. These limits are designed to provide reasonable protection against harmful interference in a residential installation. This equipment generates, uses, and can radiate radio frequency energy and, if not installed and used in accordance with the instructions, may cause harmful interference to radio communications. However, there is no guarantee that interference will not occur in a particular installation. If this equipment does cause harmful interference to radio or television reception, which can be determined by turning the equipment off and on, the user is encouraged to try to correct the interference by one or more of the following measures:

- Reorient or relocate the receiving antenna.
- Increase the separation between the equipment and receiver.
- Connect the equipment into an outlet on a circuit different from that to which the receiver is connected.

Consult your local RadioShack store or an experienced radio/TV technician for help.

If you cannot eliminate the interference, the FCC requires that you stop using your Wicked Wing. Changes or modifications not expressly approved by RadioShack may cause interference and void the user's authority to operate the equipment.

Product	Wicked Wing
Model	60-4395
Responsible Party	RadioShack 100 Throckmorton Fort Worth, TX 76102
Phone	817-415-3200

This device complies with Part 15 of the FCC Rules. Operation is subject to the following two conditions: (1) This device may not cause harmful interference, and (2) This device must accept any interference received, including interference that may cause undesired operation.

care and use

- Keep your Wicked Wing, charger, charging cord, and transmitter dry. If they get wet, wipe them dry immediately.
- Use and store the Wicked Wing, charger, charging cord, and transmitter only in room temperature environments.
- Handle the Wicked Wing, transmitter, charging cord, and charger carefully. Do not drop them.
- Do not play with the Wicked Wing on hairy or carpeted surfaces, as hair or lint can damage the wheel gears.

- Keep the Wicked Wing, charger, charging cord, and transmitter away from dust and dirt, and wipe them with a damp cloth occasionally to keep them looking new.
- Do not play with your vehicle in the street.
- Your Wicked Wing may perform differently on different types of surfaces.
- If your Wicked Wing is not performing as it should, take it to your local RadioShack store for assistance.
- Driving your Wicked Wing for long periods of time can generate a high heat level, which causes wear

and tear on the motor. To help keep heat levels down, when your vehicle's battery power dies, let it cool for at least 10 minutes before charging.

- Do not touch the motor or batteries immediately after using the Wicked Wing, as they may become hot during use.
- If your Wicked Wing's motor runs, but does not respond to the transmitter, move closer to the vehicle and try again.
- If someone uses a CB nearby, it might interfere with the control of your Wicked Wing. If this happens, move the vehicle away from the CB.
- You cannot operate your Wicked Wing near devices with transmitters that use the same frequency as your vehicle (27 MHz or 49 MHz). Check the box to see which frequency you have.

Free Manuals Download Website

<http://myh66.com>

<http://usermanuals.us>

<http://www.somanuals.com>

<http://www.4manuals.cc>

<http://www.manual-lib.com>

<http://www.404manual.com>

<http://www.luxmanual.com>

<http://aubethermostatmanual.com>

Golf course search by state

<http://golfingnear.com>

Email search by domain

<http://emailbydomain.com>

Auto manuals search

<http://auto.somanuals.com>

TV manuals search

<http://tv.somanuals.com>