

PYLE[®] PLCD41MP



CD/MP3 PLAYER.....
AM/FM RECEIVER

OWNER'S MANUAL
C a r A u d i o H i f i S y s t e m

Contents

Safety precautions.....	2	Play operation.....	8
Wiring diagram	3	Play/pause	
Radio wiring		Scan	
Speaker wiring		Repeat	
Installation	4	Shf	
Install the unit		Radio operation.....	9
Removing the unit		Band	
General features.....	5	Band tuner	
Power		Direct access tuning	
Volume		Remote control.....	10
Eject		Loading and Replacing the battery	
Mode		Basic operation	
Loud		Accessories	11
Dsp		Specifications	12
Clock		Trouble shooting	13
Release			
Speaker setting.....	7		
Volume setting			
Bass setting			
Treble setting			
Balance setting			
Fader setting			

Safety precautions

▲ WARNING

To prevent injury or fire, take the following precautions:

- Insert the unit until it is firmly locked to the main unit, otherwise it may fall out of place when jolted
- When extending the ignition, memory back up or ground cable, use diameter of 0.75mm(AWG18) or more automotive grade cable to avoid wire deterioration or damage to the wire coating.
- To prevent short circuit, never put or leave any metallic object into the unit.
- If you smell or see smoke, turn off the power immediately and consult your dealer.
- Be careful not to drop or shock the unit strongly, it may break or crack because it contain glass parts.

▲ CAUTION

To prevent damage to the machine, take the following precautions:

- Be sure the unit is connected to a 12V DC power with a Negative Ground
- The unit is only designed for use with 4 speakers. Do not combine output for use with 2 speakers. Do not ground negative speaker leads to the chassis ground
- Do not open the top cover and do not install the unit in place where it is exposed to direct sunlight (including the faceplate), in order to avoid high heat or humidity, water splash over it or dust.
- Do not touch the terminals of the units.
- If you have difficulty in installing this unit in your vehicle. Please contact your dealer.
- If the unit seems not work in properly press the reset button to reset the memory of the unit.

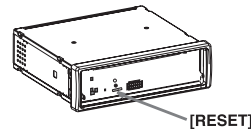

Attaching panel

Attach the front panel by fixing the left side of it into this unit as 1 showing. Then push the right side of panel towards into connecting plug as 2 showing.

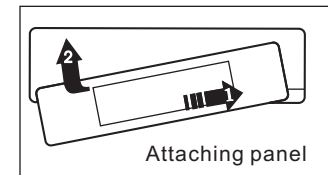

Wiring diagram

Follow this easy wiring diagram in order to enable you to install the new or existing RADIO and SPEAKER wiring system.

Be sure the unit is connected to a 12 volts battery with negative ground. Good ground connections eliminate most electrical noise problem and require tight with the metal vehicle chassis. remove plastic, paint or dust for good electrical contact.

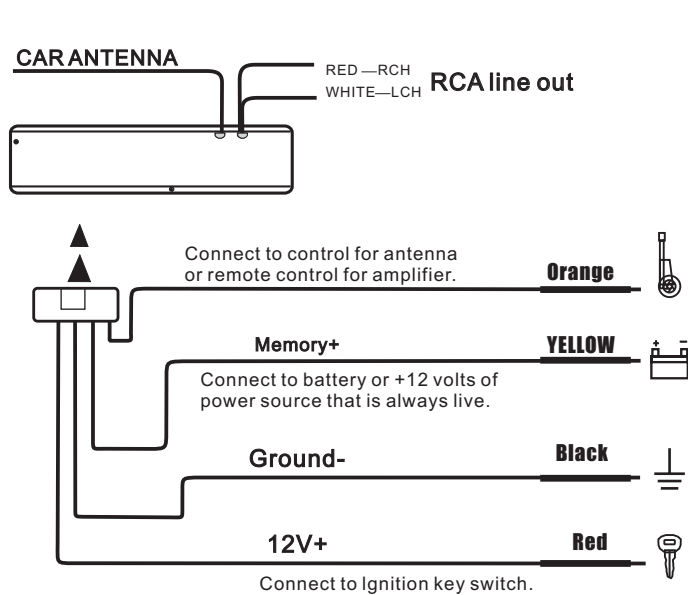

SPEAKER WIRING

The unit is only designed for the use with 4 speakers system, it can only be connected with speakers rated in the load impedance range from 4 to 8 ohms. Load impedance less than 4 ohms could damage the unit.

Never combine (BRIDGE) the outputs for use with 2 speakers, and Never ground any Negative speaker to the chassis ground.

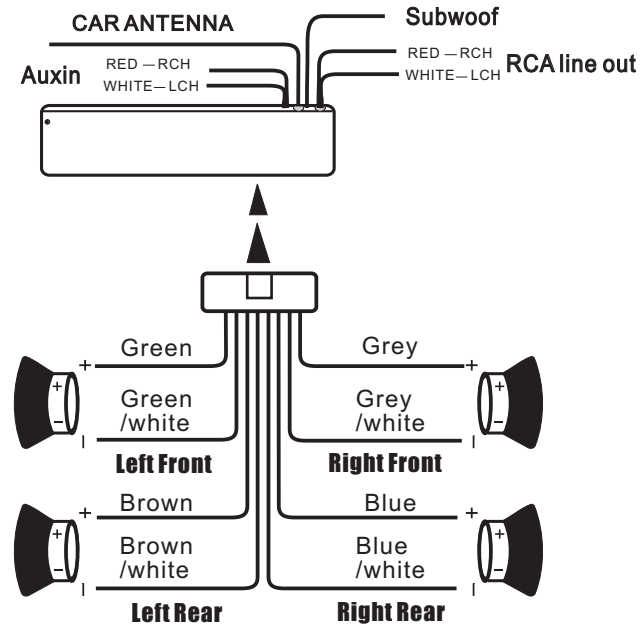

Installation

Before installing the receiver permanently, fit it in the approximate place in your car. Connect the equipment according to the speakers and electrical connections. When your system is operated properly, (preferably with the car engine running), follow the instructions for permanent installation of your system.

INSTALL THE UNIT

- 1) Install half sleeve, can be with or without adapter. It will fit better with adapter.
- 2) Bend over some tabs where possible to secure the half sleeve inside of dash.
- 3) Support strap to be struted under dash, secure this strip to avoid skipping of disc.

REMOVING THE UNIT

- 1) Insert removal wrench into the small gap on the right side of the unit and pull the unit slightly out on the same side, then release the wrench. Repeat the same action for the left side. By now, you can remove the unit and unplug the wires connector.

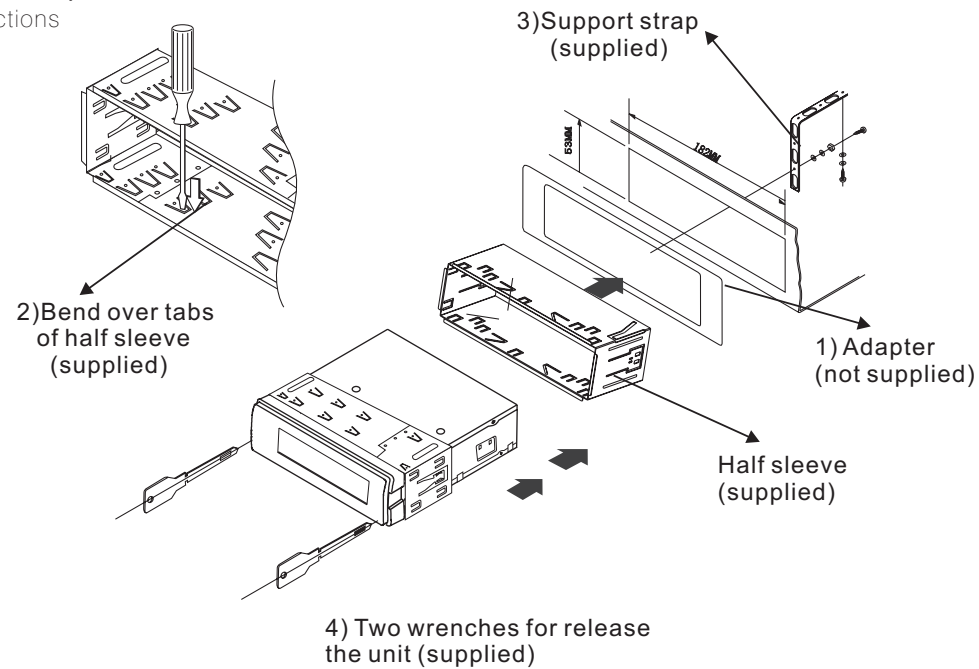

Power/volume/eject

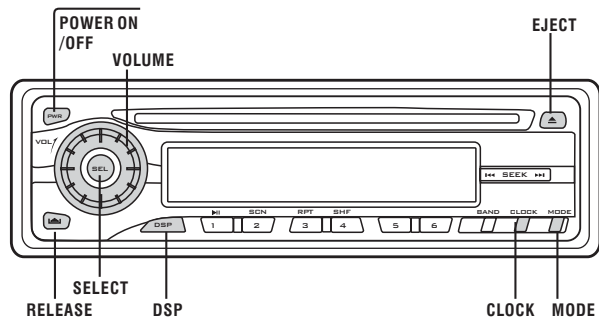

LCD display

Power

Turning ON the power

Press the [PWR]button.



Press to turn on the unit power, Press the button to turn off the unit.

Volume

Increasing volume

Rotate the [VOL+]button

Decreasing

Rotate the [VOL-]button

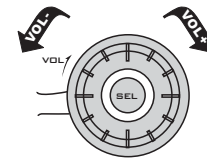

Eject

Out

Press the [\blacktriangle]button to eject the disc out of the unit .

In

Press the [\blacktriangle]button again, to load the disc in.

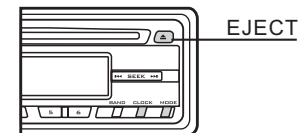

Modet/Loud/Clock/Dsp/Release

MODE

Selecting radio and play

 Press the [MODE]key.

Each time you press the key, it`ll switch between radio and CD position.

(If mode with AUX IN,the function is below:
press MD(MODE)to select:

1、 If with DISC,press MD that is:

AUX IN → RADIO → DISC → AUX IN

2、 If without DISC,press MD that is:

AUX IN → RADIO → AUX IN

Band(Loud)

LOUD

Long press the [BD/LD]button to emphasize the bass output,
Long press it again to resume the normal listening.

Clock

Short press CLK can display time even power off .
Long Press CLK for 3 seconds will enter set mode.

Hour

Press [▶▶] button to set the hour.

Minute

Press [◀◀] button to set the minute.

Quit clock set mode

It will quit clock set mode If there is no operation
in 5 seconds.

Dsp

 Short press this button to "DSP" :

Press "LOUD" button once, "ROCK" will bicker on display.

Press "LOUD" button twice, "POP" will bicker on display.

Press "LOUD" button third, "CLASS" will bicker on display.

Release

 press the "  " button to release faceplate.

SPEAKER SETTING

Speaker mode

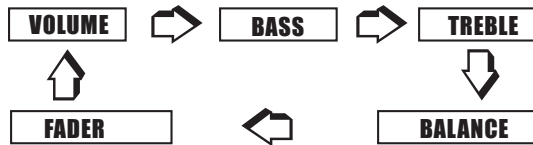

▲ NOTE

In press mode, VOL is sel function

● Volume set mode

Press “SEL” button once, display shows “VOL” , then rotate the volume “+” button to adjust volume level up. rotate the volume “-” button to adjust volume level down.

VOL 10

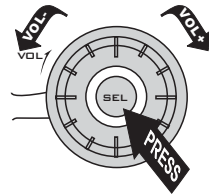

● Bass set mode

Press “SEL” button twice, display shows “BAS” , then rotate the volume “+” button to adjust bass level up. rotate the volume “-” button to adjust bass level down.

BAS -6

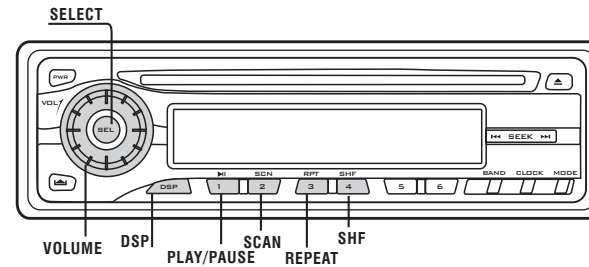

● Treble set mode

Press “SEL” button third, display shows “TRE” , then rotate the volume “+” button to adjust treble level up. Rotate the volume “-” button to adjust treble level down.

TRE 5

● Balance set mode

Press “SEL” button fourth display shows “BAL” , then rotate the volume “+” button to adjust right speaks level . Rotate the volume “-” button to adjust left speaks level .

BAL 4

● Fader set mode

Press “SEL” button fifth, display shows “FAD” , then rotate the volume “+” button to adjust rear speaks level. Rotate the volume “-” button to adjust front speaks level.

FAD -3

PLAY CONTROL

Play/pause

Pause

If with DISC in unit, Press the [▶||] to pause music.

Play

Press the [▶||] button again, then come back to DISC playing.

Shf

Press [SHF] button

 Press [SHUF] button to play all the track in random order. SHF and playing song number will appear on the LCD. Press [SHUF] again will stop random playing.

Scan

Press [SCN] button

 Press this button once for TRACK INTRODUCTION. The first 10 seconds of each track on the disc will play. And the track number shows on LCD. To select a desired song, press [SCN] button while it is playing.

Repeat

Press [RPT] button

 REPEAT
Press [REPEAT] button to repeat the track continuously. RPT and the playing song number will appear on the LCD. Press [REPEAT] again will be back to normal playing.

RADIO OPERATION

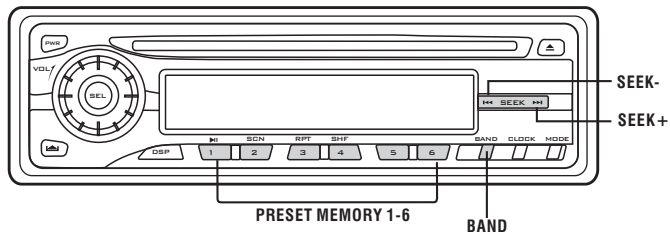

Band

Selecting band

Press BAND button to select among three FM or two AM bands. (FM1-FM2-FM3-AM)

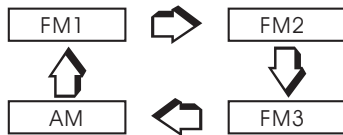

If with DISC in unit, press [MODE] switch to radio MODE first.

Tuner

In radio mode:

manual tuning:

short press ►► button it can select higher frequency station.
Short press ◄◄ can select lower frequency station.

Auto loading tuning:

the long press ►► button it can automatically select higher frequency station. And the long press ◄◄ it can automatically select lower frequency station.

Preset memory

Manual Preset Station

Please keep pressing any of the No. 1-6 button to store when you hear the favorite broadcasting station.

Automatic Preset Station

In any band play, keep pressing AS/PS on the remote control into automatic storage. And 6 powerful stations in this band will be stored into NO. 1-6 respectively.

There are 6 bands for selection:FM1 ,FM2,FM3,AM.Make selection by pressing BAND Button.

Selecting and pressing the buttons stored,you can play the station you want then.

REMOTE CONTROL

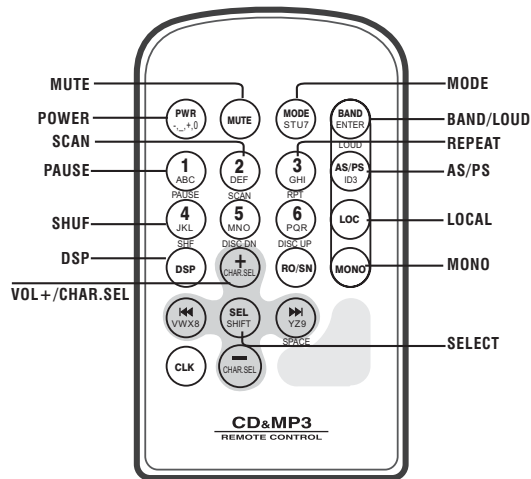

Function list for remote control

PWR	_, -, +, 0, PWR	AS/PS	Mode select
MUTE	MUTE	LOC	LOC
MODE	S, T, U, 7, MODE	DSP	DSP
BAND	Enter, BAND	+/-	Char.sel(A, B~8, 9, 0), +/-
1	A, B, C, 1, PAUSE	R.SCN	RADIO.SCAN
2	D, E, F, 2, SCAN	MONO	MONO
3	G, H, I, 3, REPEAT	▶▶	Y, Z, 9, space, ▶▶
4	J, K, L, 4, SHUF	◀◀	V, W, X, 8, ◀◀
5	M, N, O, 5, DISC DN	SEL	Char.shift, SEL
6	P, Q, R, 6, DISC UP	CLK	CLK

Loading and replacing the battery

Use one lithium battery(CR2025) insert the batteries with the + and - poles aligned properly. Following the illustration inside the case.

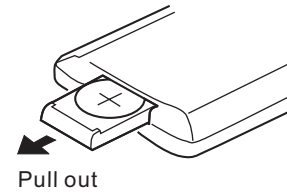

⚠ WARNING

Store unused batteries out of the reach of children. Contact a doctor immediately if the battery is accidentally swallowed.



Do not set the remote on hot places such as above the dashboard.

Basic operation

Turning ON the power

Press the [PWR] button.



Press to turn on the unit power, Press the button to turn off the unit.

Basic operations of remote

ID3

Press ID3 on remote or Panel enter ID3 selection. one press ID3 enter ID3 file selection mode, F will be indicated on LCD.

To read in your desired song name by pressing remote (F) (L) buttons, then press (M) confirmed the song playing.

EXAMPLE: to read in " I LOVE YOU"

In the read in mode: press (M) button three times read I, press (M) turn to next word, press (L) three times read L, press (F) three times read O and so on...

Two press ID3 enter ID3 directory mode, D will be indicated on LCD. Press (M) / (M) select desired directory, then press (M) confirmed playing.

In read in song name mode, press (M) clear wrong written words. press (F) turn to next word.

▲ NOTE

ID3 only value as MP3 disc in.

Other function

Please refer to panel.

▲ CAUTION

Remote operation the same of mainframe.

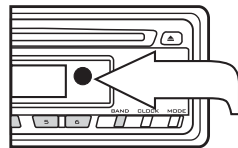

Window of Remote

Accessories

External view

..... Number of items

①	1
②	1
③	1
④	2

External view

..... Number of items

⑤	1
⑥	1
⑦	1



The use of any accessories except of those provided might result in damage to the unit .make sure only to use the accessories shipped with the unit ,as shown above.

Specifications

Specifications subject to change without notice.

CD PLAYER

Signal/Noise ratio.....70dB
Frequency response.....20Hz-20KHz(+3dB)
Channel separation.....>45dB
Dual D/A converter.....16Bit

FM Tuner

Tuning range.....USA:87.5-108MHz
(100KHz step)
EUROPE:87.5-108.0MHz
(50KHz step)
FM usable sensitivity(S/N=30dB).....<12dB
Stereo separation.....>45dB

AM Tuner

Tuning range.....USA:520-1620KHz
(10KHz step)
EUROPE:522-1620KHz
(9KHz step)
AM sensitivity.....28dB

GENERAL

Operating power.....12 Volts DC,negative
ground
%10THD output wiring.....Designed for using four
speakers only front and rear
channels cannot be combined
in use with 2speakers.
Load impedance.....compatible 4 to 8 ohm
speakers
Fuses.....1amp and 10 amp
Dimensions.....178mm(L)x50mm(W)
x150mm(H)
Weight.....2.5Kgs

Troubleshooting guide

What might seem to be a malfunction in your unit may just be the result of slight misoperation or miswiring. Before calling service, first check the following table for possible problems.

?The power does not turn ON.

- ✓ The fuse has blown.

 Install half sleeve, can be with or

?NO Sound.

- ✓ The cable connect incorrectness.

 Exactitude connect of the cable.

?Noise on Radiopoor recepton

- ✓ Antenna and Antenna Cable.

 Check antenna and antenna cable, the antenna base must be grounded and connected with good condition, repace antenna or antenna cable if needed.

?Noise on both Radio and CD

- ✓ Poor ground,dirty or corroded at the car Battery posts

 Check the black wire for proper grounding clean and tighten ground connection.

?No/Poor sound on one or more speakers

- ✓ Speakers or speaker wiring or volume, Balance and Fader setting

 Check the speaker wiring and test the speakers all in good condition check the setting of volume, Balance and Fader controls.

?CD sound skips

- ✓ Installation the unit angle is greater than 45° ,or mounting is not fixed and the back strap is not secure.

 Adjust the unit with mounting angle less than 45° and make sure the unit is mounted securely and tighten with the back strap(supplied)

?Unit completely inoperative, no Light and Sound

- ✓ Incorrect wire connection, Power RED/YELLOW or Ground wire or Blown fuse

 Check the Red wire to + 12 Volts with key Ignition witch, yellow wire to + 12 Volts battery and black wire to ground. Check Fuse with red/yellow wire, or check the fuse block on your car.

CD/MP3 PLAYER

AM/FM RECEIVER
WITH ESP FOR CD 40S, MP3 70-120S
C a r A u d i o H i f i S y s t e m

Free Manuals Download Website

<http://myh66.com>

<http://usermanuals.us>

<http://www.somanuals.com>

<http://www.4manuals.cc>

<http://www.manual-lib.com>

<http://www.404manual.com>

<http://www.luxmanual.com>

<http://aubethermostatmanual.com>

Golf course search by state

<http://golfingnear.com>

Email search by domain

<http://emailbydomain.com>

Auto manuals search

<http://auto.somanuals.com>

TV manuals search

<http://tv.somanuals.com>