

# OWNER'S MANUAL

## Mobile Video System

---

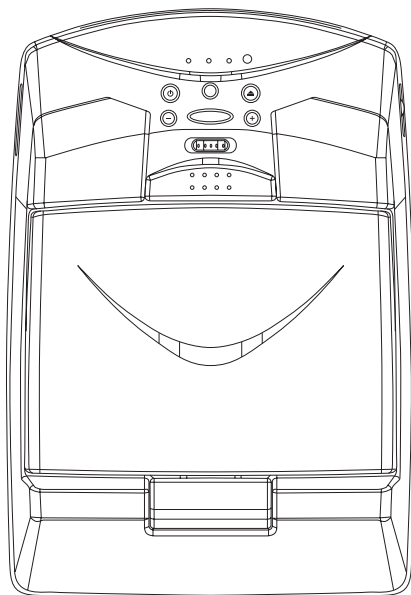

- **Digital Audio Out-Coaxial**
- **DVD Player**
- **Multi Color TFT Monitor**
- **Multi-subtitle Languages Function**
- **Multi-audio Languages Function**
- **Multi-angle Function**
- **Parental Control**
- **Remote Control**

## FEATURES

### **Compatible with PAL DVD (Video CD) and NTSC DVD (Video CD)**

This player can play discs recorded in either PAL or NTSC format.

- A single LSI chip now integrates all major DVD playback circuit functions including MPEG2 decoder, video D/A converter, and audio decoders.
- L/R stereo analog audio outputs for connection to existing head unit aux inputs. Video output is composite video.
- Supplied remote handles multi-function software (multi-language audio-track/subtitle, multi-angle, multi-story, etc.), plus all basic functions.

## USE THIS PRODUCT SAFELY

### **When Driving**

Keep the volume level low enough to be aware of road and traffic conditions.

### **When Car Washing**

Do not expose the product to water or excessive moisture. This could cause electrical shorts, fire or other damage.

### **When Parked**

Parking in direct sunlight can produce very high temperatures inside your vehicle. Give the interior a chance to cool down before starting playback.

### **Use the Proper Power Supply**

This product is designed to operate with a 12 volt DC, negative ground battery system (the regular system in a North American car).

### **Protect the Disc Mechanism**

Avoid inserting any foreign objects into the slot of this player.

Failure to observe this may cause malfunction due to the precise mechanism of this unit.

### **Use Authorized Service Centres**

Do not attempt to disassemble or adjust this precision product. Please refer to the Service Centre list included with this product for service assistance.

### **For Installation**

The unit should be installed in a horizontal position with the front end up at a convenient angle, but not more than 30°.

# CONTENTS

---

<b>Safety Information .....</b>	<b>4</b>
<b>Disc Notes .....</b>	<b>5</b>
<b>The Player .....</b>	<b>6</b>
<b>Installation .....</b>	<b>8</b>
<b>Replacing the Car Demo Lamp .....</b>	<b>9</b>
<b>Electric Connection .....</b>	<b>10</b>
<b>Remote Control .....</b>	<b>11</b>
Location and Function of Keys .....	11
Preparing the Remote Control .....	13
<b>Loading/Ejecting a disc .....</b>	<b>13</b>
Loading a Disc .....	13
Ejecting a Disc .....	13
<b>Operation .....</b>	<b>14</b>
Basic Play .....	14
Menu Function .....	16
On-Screen Display Function .....	16
Multi-audio Language Function .....	17
Title Menu Function .....	18
Multi-Subtitle Language Function .....	18
Multi-angle Function .....	18
MP3 Disc Play .....	18
<b>Setup .....</b>	<b>19</b>
Initial Setup .....	19
General Setup .....	19
Speaker Setup .....	21
Audio Setup .....	21
Preferences Setup .....	22
Defaults Table .....	24
<b>Trouble Shooting .....</b>	<b>25</b>
<b>Specifications .....</b>	<b>26</b>

# SAFETY INFORMATION

---

## CAUTION:

MOBILE DVD PLAYER IS A CLASS I LASER PRODUCT. HOWEVER THIS MOBILE DVD PLAYER USES A VISIBLE/INVISIBLE LASER BEAM WHICH COULD CAUSE HAZARDOUS RADIATION EXPOSURE IF DIRECTED. BE SURE TO OPERATE THE MOBILE DVD PLAYER CORRECTLY AS INSTRUCTED. USE OF CONTROLS OR ADJUSTMENTS OR PERFORMANCE OF PROCEDURES OTHER THAN THOSE SPECIFIED HEREIN MAY RESULT IN HAZARDOUS RADIATION EXPOSURE. DO NOT OPEN COVERS AND - DO NOT REPAIR YOURSELF. REFER SERVICING TO QUALIFIED PERSONNEL.

## WARNING:

- TO REDUCE THE RISK OF FIRE OR ELECTRIC SHOCK, DO NOT EXPOSE THIS EQUIPMENT TO RAIN OR MOISTURE.
- TO REDUCE THE RISK OF FIRE OR ELECTRIC SHOCK, AND ANNOYING INTERFERENCE, USE ONLY THE RECOMMENDED ACCESSORIES.
- THIS DEVICE IS INTENDED FOR CONTINUOUS OPERATION.

This product incorporates copyright protection technology that is protected by method claims of certain U.S. patents and other intellectual property rights owned by Macrovision Corporation and other rights owners. Use of this copyright protection technology must be authorized by Macrovision Corporation, and is intended for home and other limited viewing uses only unless otherwise authorized by Macrovision Corporation. Reverse engineering or disassembly is prohibited.

## Region Management Information

Region Management Information: This Mobile DVD Player is designed and manufactured to respond to the Region Management Information that is recorded on a DVD disc. If the Region number described on the DVD disc does not correspond to the Region number of this Mobile DVD Player, this Mobile DVD Player cannot play this disc.

# DISC NOTES

## Disc formats supported by this player



**DVD**  
12 cm disc  
(Single-sided disc only)



**Video CD**  
12 cm disc



**CD**  
12 cm disc



**MP3**  
12 cm disc

## Discs which cannot be played with this player

- DVD-ROM
- DVD-R/DVD-RAM
- CDV
- CD-G

## Handling and Cleaning

- Dirt, dust, scratches and warping disc will cause misoperation.
- Do not place stickers or make scratches on discs.
- Do not warp discs.
- A disc should always be kept in its case when not in use to prevent from damaging.
- Do not place discs in the following places:
  1. Direct sunlight
  2. Dirty, dusty and damp areas
  3. Near car heaters
  4. On the seats or dashboard

## Disc Cleaning

Use a dry soft cloth to wipe the surface. If the disc is quite dirty, use a soft cloth slightly moistured with isopropyl (rubbing) alcohol. Never use solvents such as benzine, thinner or conventional record cleaners as they may mar the surface of the disc.

### Note:

A disc may become somewhat scratched (although not enough to make it unusable) depending on your handle it and conditions in the usage environment.

Note these scratches are not an indication of any problem with the player.

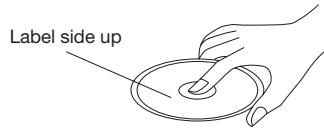

Do not touch the underside of the disc

Do not bend

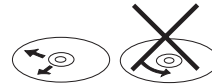

Wipe the disc from center toward the outside edge

## Preparing New Discs with Rough Spots

A new disc may have rough edges on its inside and outside edges. If a disc with rough edges is used, the proper setting will not be performed and the player will not play the disc. Therefore, remove the rough edges in advance by using a ball point pen or pencil as shown below. To remove the rough edges, press the side of the pen or pencil against the inside and outside edges of the disc.

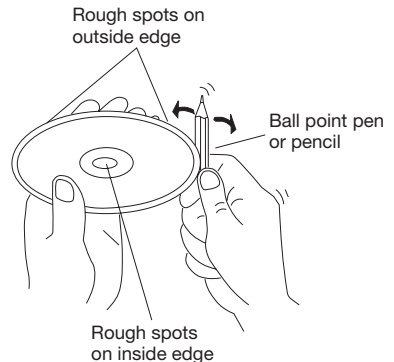

# THE PLAYER

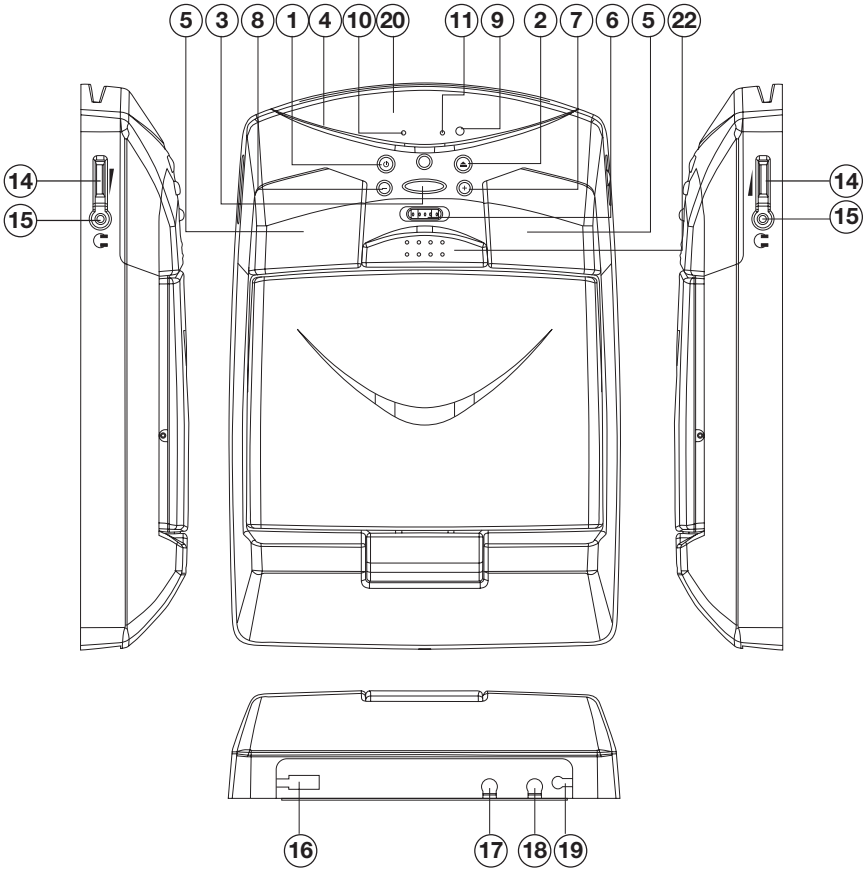

# THE PLAYER

---

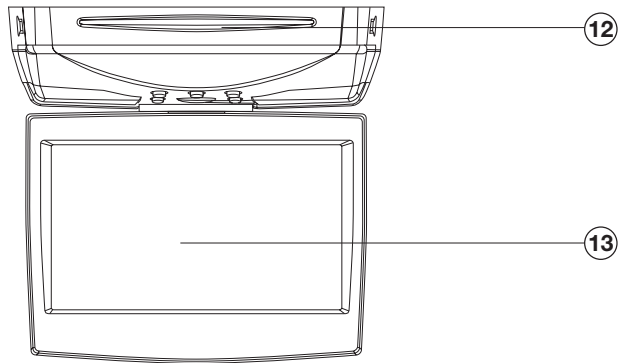

7 INCH TFT COLOR MONITOR

1. POWER (⏻)
2. EJECT (▲)
3. MENU
4. MOD
5. Car Dome Lamp
6. Light Switch
7. VOLUME +
8. VOLUME -
9. IR
10. Indicator Light for DVD
11. Indicator Light for AV
12. Disc slot
13. 7 inch TFT Color Monitor
14. Earphone volume control knob
15. Jacks for Earphone
16. DC 12V IN
17. AV IN
18. AV OUT
19. DIGITAL AUDIO
20. INFRARED TRANSMITTING WINDOW (For the unit with infrared transmitting function only)
21. Open button: Press the button to eject the screen display from the base at a little angle.

# INSTALLATION

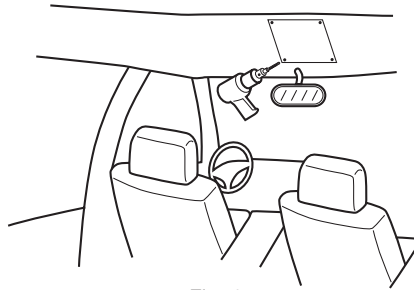

Fig. 1

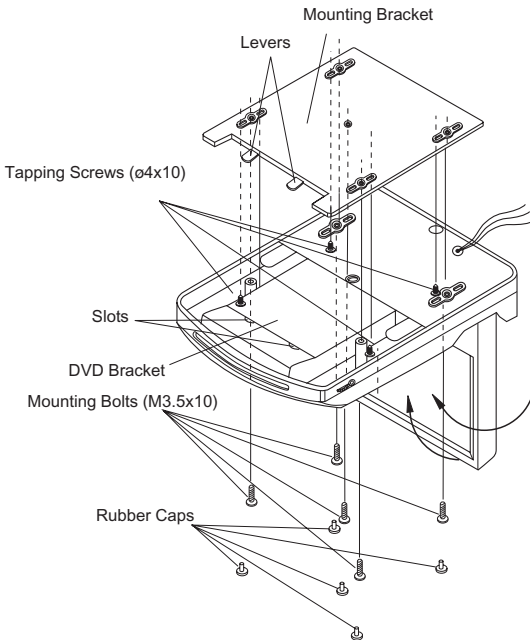

Fig. 2

1. Determine the mounting location and drill four mounting holes (See Fig.1).
2. Attach the mounting bracket to the holes with the tapping screws ( $\varnothing 4 \times 10$ ).
3. Let the two levers aim at the slots on the DVD bracket to fix the display unit.
4. Open the monitor to display the five screw holes.
5. Attach the unit to the bracket with the mounting bolts (M 3.5x10).
6. Insert five rubber caps to the screw holes.
7. When the installation has completed, you can also turn the display upward or downward, left or right to adjust the viewing angle. (See the arrowhead symbol in Fig.2).



# REPLACING THE CAR DOME LAMP

Follow the directions shown below for a new lamp changing.

1. Press the open button to eject the screen display and turn it upward.
2. Position light switch to "OFF".
3. Push back the lamp cover and open it. (Refer to the following figure)
4. Remove and discard the old lamp.
5. Install a new bulb.
6. Close the cover.

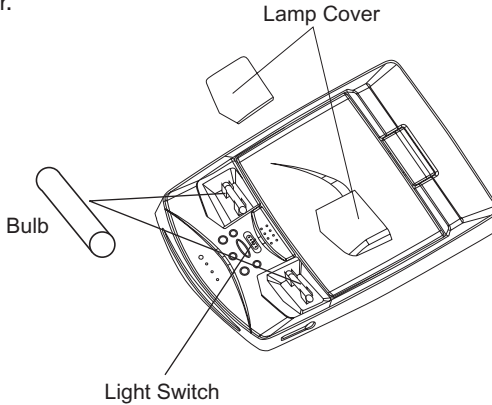

## Bulb Specification

Diameter:  $\varnothing 8\text{mm}$   
Length: 28mm  
Voltage Spec.: DC12V, 5W

## CAR DOME LAMP WIRING

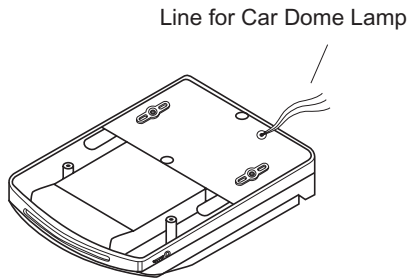

### Note:

Color	Connection
Red	Power Supply
White	Interior Light System
Black	Ground

# ELECTRIC CONNECTION

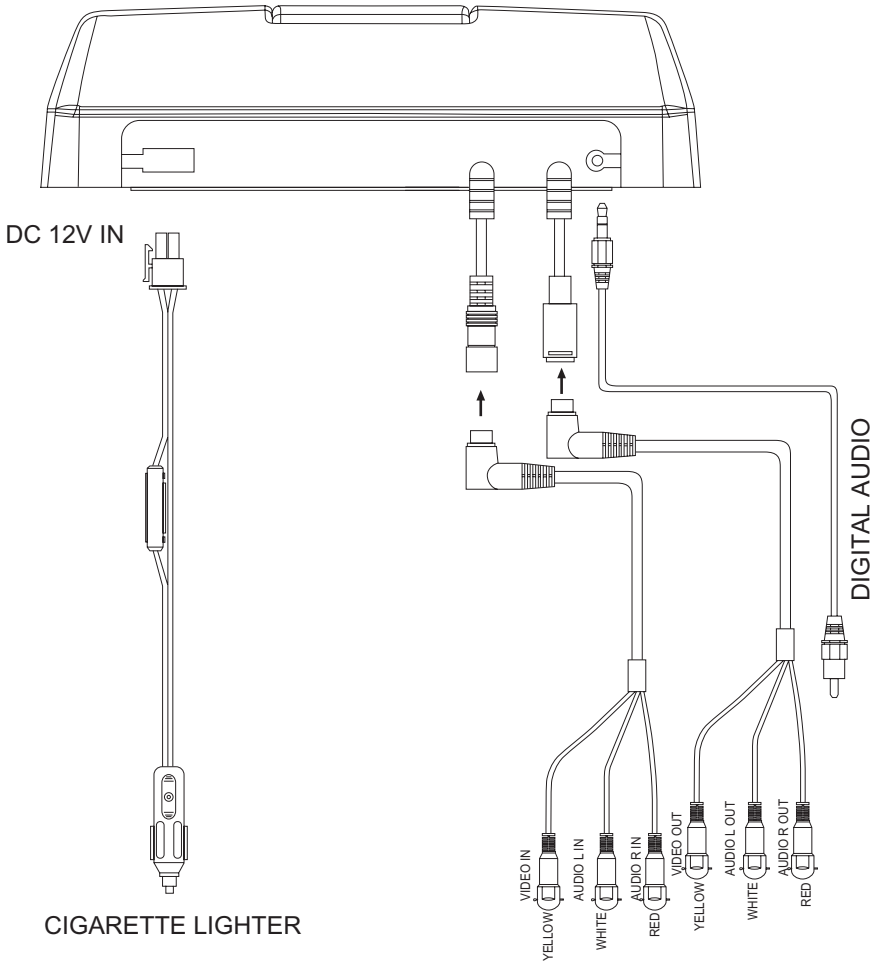





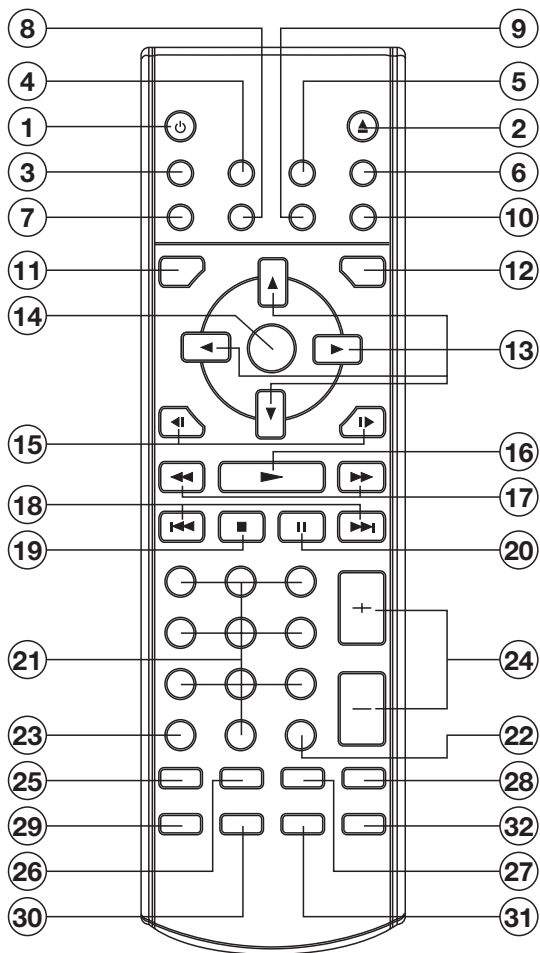

















# REMOTE CONTROL

## LOCATION AND FUNCTION KEYS



## REMOTE CONTROL

---

1.  POWER Press POWER to turn the unit ON or OFF.
2. EJECT Press to eject the disc.
3. MUTE Press to mute the sound.
4. SUBTITLE Changing of the SUBTITLE language on multi-subtitle language DVD disc.
5. ANGLE Changing of the view angle on multi-angle DVD disc.
6. DISPLAY Display statistical disc information during playback.
7. MODE Changing between DVD mode and AV mode.
8. SETUP Display the SETUP menu.
9. PAL/NTSC Switch between PAL mode and NTSC mode.
10. AUDIO Changing of the AUDIO soundtrack on multi-audio soundtrack DVD disc. Changing of the sound mode of the VCD/CD disc.
11. TITLE Display the TITLE menu that is stored in DVD disc.
12. MENU Display the adjustment items, such as Bright, Contrast, Color, Tint, Transmit, Screen and etc.
13.   ,   In case of MENU mode,   ,   buttons served as cursor buttons to select item left/right, ahead/back.
14. ENTER Confirm the Track/Chapter selected with the numeric buttons or selected with the cursor buttons on screen display.
15.   Changing for slow forward/reverse playback motion.
16.  Press to play the disc.
17.   Press  to search forward rapidly &  to search reverse rapidly.
18.   Press  to skip to the next track & press  to skip back one track.
19.  Press it to stop playback.
20.  Press it to pause playback.
21. 0 - 9 Numeric buttons
22. 10+ Digital selecting button, cooperatively used with numeric buttons.
23. CLEAR When you input a number in error, press the button to clear it.
24. VOLUME+/- Press VOLUME+/- button to increase or decrease the volume level.
25. ZOOM Allows the picture to be increased in size.
26. RESUME When in stop mode, press the button, then play can be resumed from the stop point.
27. GOTO Disc search button, cooperatively used with numeric buttons.
28. PBC Changing between PBC ON and PBC OFF on the VCD disc.
29. RANDOM Allows the track played in random order.
30. PROGRAM Allows the track played in the order you programmed.
31. REPEAT Switch the Repeat mode of discs.
32. A-B A-B repeat allows a passage to be repeated continuously.

# REMOTE CONTROL

---

## Preparing the Remote Control

### *Inserting the Batteries*

1. Open the battery compartment cover.
2. Insert the new batteries. Make sure that the positive and negative terminals of the batteries are oriented as indicated.
3. Close the cover  
Battery: Two AAA size battery.

### *Using the Remote Control*

Face the remote control towards the player front face **IR** mark (remote control signal receiver).

Operation angle: About  $\pm 30$  degree in each the direction of the front of the IR mark.

## LOADING/EJECTING A DISC

---

### Loading a Disc

When you have installed the unit and all connections have completed, you can load a disc as follows:

1. Turn the ignition on the the accessory position.
2. Press the **POWER** button (1).
3. Insert the disc with printed side facing up into the disc slot (2) (see below).
4. The player will start playback automatically.

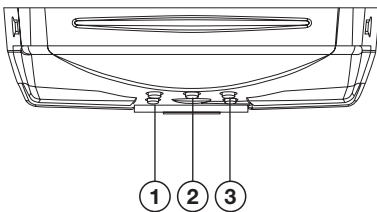

### Ejecting a Disc

Press **▲ (EJECT)** button (3) to eject the disc.

# OPERATION

## BASIC PLAY

### STOPPING PLAY

- Brief press the ■ (Stop) button to stop the unit playback, when the ► (Play) button is pressed, normal playback will continue.
- Press ■ (Stop) button twice to stop the playback and go back to initial Track/Chapter.

### RAPID FORWARD/RAPID REVERSE

Press ►► & ◀◀ during play. Each time the button is pressed, the speed of rapid forward/reverse changes according to the disc as follow.

DVD:



VCD/CD:

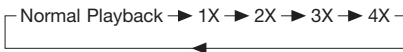

MP3:

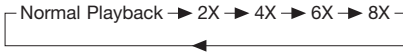

### SKIPPING TRACK

Press ►►/◀◀ buttons on the remote control during playback.

Press ►► to skip to next track, and ◀◀ to back one track.

Note: For some VCD 2.0 discs (PBC-playback control), ►►/◀◀ buttons may be unavailable.

### SLOW MOTION PLAY

Press ► / ◀ during play. Each time the button is pressed, the speed of slow forward/reverse changes according to the disc as follow.

DVD:



## PAUSE

Pressing II on the remote control during playback will stop play temporary. To return to normal playback, press ► on the remoter control.

## MUTE

Will mute the sound, but the disc continues playing. When you unmute the sound (press MUTE again), sound will resume.

## REPEAT

FOR DVD:

Press the **REPEAT** button to select repeat mode as follow.



FOR VCD/CD:

Press the **REPEAT** button to select repeat mode as follow.



1. Continuously repeat at the current chapter/track, when selected REP-ONE mode.
2. Select REP-ALL mode to continuously repeat all chapter/track on the current disc.
3. When the player finishes playback the current disc last chapter/track, it will stop and display the elapsed time. When REPEAT OFF mode is selected, REP-ONE & REP-ALL disappears from screen display.
4. REPEAT feature does not support VCD2.0 (with PBC ON).

## A-B

A-B repeat allows a passage to be repeated continuously. Press **A-B** button at the start of the required passage, then press **A-B** button again at the end of the passage. To revert to normal playing, press **A-B** button again. Each time the button pressed, the screen will display as follows:

A TO B SET A -> A TO B SET B -> A TO B CANCELLED

# OPERATION

## DISC SEARCH (GOTO)

FOR DVD

Press **GOTO** button twice, the screen will display the following message:

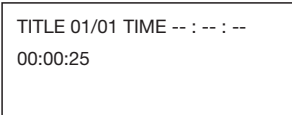

You can select the item you want to watch through TIME setting by using numeric buttons and ENTER key.

FOR CD/VCD (WITH PBC OFF):

Press **GOTO** button once, the screen will display the following message:

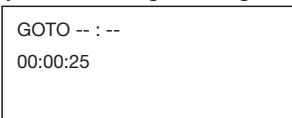

Use numeric buttons to input the time directly.

## ZOOM

Allows the picture to be increased in size. Press **ZOOM** to toggle among 1.5 scale, 2.0 scale and 3.0 scale.

## RANDOM

Press **RANDOM** button, track selection will be made in random order. The display screen will show "SHUFFLE ON" on the screen. Press **RANDOM** button again, "SHUFFLE OFF" appears and release the mode.

## PROGRAM

In stop mode, press **PROGRAM** button, the screen will display "PROGRAM P00:00". For example: press numeric button 4 and ► button, "PROGRAM P01:04" appears. It means track 4 will be played first.

## MODE SELECTION

Press **MOD** button on the front panel of the unit or **MODE** button on the remote control to select among DVD and AV mode. When select one mode, the corresponding indicator on the front panel will be illuminated.

## VOLUME LEVEL ADJUSTMENT

Press **VOL +/VOL -** on the front panel or **VOLUME +/-** on the remote control to increase or decrease the volume level.

## LIGHT SWITCH

The two car dome lamps on the unit will be on in some needed situations. There are three settings for the car dome lamp operation: OFF, AUTO, and ON, refer to the light switch.

- A. **OFF**: To turn off the lamp.
- B. **AUTO**: To make the lamp turned on only when car doors are opened.
- C. **ON**: To turn on the lamp.

## JACK FOR EARPHONE ( )

There are two jacks for earphone. You can connect an earphone to anyone of the jacks to receive sound signal.

## EARPHONE VOLUME ADJUSTMENT

Slide the knob on the side of the DVD unit to increase or decrease the volume level of the earphone.

## REMOTE SENSOR (IR)

Point the remote handset to the remote sensor **IR** on the front panel. Receive the signal from remote handset.

## TURNING THE UNIT ON/OFF

Press the ⏻ (**POWER**) button on the front panel or on the remote control to turn the unit on or off.

## Monitor Release

Press the button on the unit to eject the screen display from the base at a little angle. Then you can easily turn the display upward or downward for good viewing.

## INFRARED TRANSMITTING WINDOW

There are six infrared transmitting lights inside the window on the unit, the user can put on the infrared wireless headphones supplied with the unit and hear the sound signal emitting from the window.

## SPEAKER ON/OFF SWITCH:

When you eject the monitor and turn it upward, you will see a speaker on/off switch on the base. Press it to switch the speakers on/off.

# OPERATION

## MENU FUNCTION

Press the **MENU** button on the unit or on the remote control during DVD, AV mode to display the adjustment items on the screen.

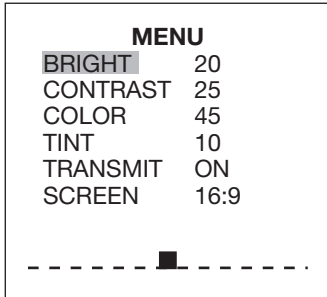

Press **MENU** button repeatedly to select among BRIGHT, CONTRAST, COLOR and TINT (For the unit with NTSC system) items and etc. Press **VOL+/VOL-** buttons on the unit or **VOLUME +/-** buttons on the remote control to adjust the corresponding item.

**Note:** When you set the TV TYPE item to "PAL" in "PREFERENCES SETUP", there is no "TINT" item to display. The TRANSMIT item is effective when the unit has the infrared transmitting function. In TRANSMIT item, there is ON or OFF to be selected. When set it to ON, the sound signal can be emitted from the infrared transmitting window on the unit and you can use the infrared wireless headphone to hear the sound signal. In SCREEN item, you can select appropriate TV aspect ratio (4:3 or 16:9) using the **VOL +/VOL-** buttons on the unit or **VOLUME +/-** buttons on the remote control.

## ON-SCREEN DISPLAY FUNCTION

Press the **DISPLAY** button during playback to display the contents of the current disc on the screen.

Example:

DVD:

- (1) Press **DISPLAY** for the first time:

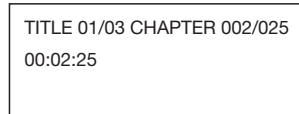

Title Number, Total Title Number, Chapter Number, Total Chapter Number of this Title of the disc currently being played will be shown on the screen, along with the elapsed time.

- (2) Press **DISPLAY** for the second time:

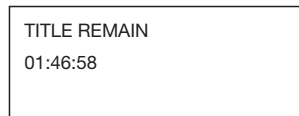

- (3) Press **DISPLAY** for the third time:



- (4) Press **DISPLAY** for the fourth time:

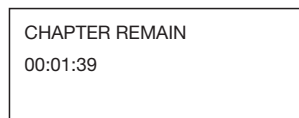

- (5) Press **DISPLAY** for the fifth time:

The message on the screen will be cleared.

VCD:

- (1) Press **DISPLAY** for the first time:





# OPERATION

(2) Press **DISPLAY** for the second time:

SINGLE REMAIN  
00:03:15

(3) Press **DISPLAY** for the third time:

TOTAL ELAPSED  
00:00:25

(4) Press **DISPLAY** for the fourth time:

TOTAL REMAIN  
00:40:35

(5) Press **DISPLAY** for the fifth time:

The message on the screen will be cleared.

CD:

(1) Press **DISPLAY** for the first time:

SINGLE ELAPSED  
00:00:25  
  
TRACK : 01/14

(2) Press **DISPLAY** for the second time:

SINGLE REMAIN  
00:03:15  
  
TRACK : 01/14

(3) Press **DISPLAY** for the third time:

TOTAL ELAPSED  
00:00:25  
  
TRACK : 01/14

(4) Press **DISPLAY** for the fourth time:

TOTAL REMAIN  
00:40:35  
  
TRACK : 01/14

(5) Press **DISPLAY** for the fifth time:

The message on the screen will be cleared.

MP3 (When set to NO MENU in SMART NAV item):

(1) Press **DISPLAY** for the first time:

CHAPTER ELAPSED 00:00:25  
  
TRACK : 01/123

(2) Press **DISPLAY** for the second time:

CHAPTER REMAIN 00:04:25  
  
TRACK : 01/123

(3) Press **DISPLAY** for the third time:

The message on the screen will be cleared.

## MULTI-AUDIO LANGUAGE FUNCTION For DVD:

Press **AUDIO** on the remote control during playback.

Each time the button is pressed, the audio soundtrack language changes in sequential order.

Notes:

- The language number is different according to the disc.
- Some disc only contain one language soundtrack.
- When no different language soundtrack are recorded,  will be displayed at screen left top corner.

## For VCD/CD:

Press **AUDIO** on the remote control during playback.

It is possible to switch the sound between monaural and stereo sound.

# OPERATION



## TITLE MENU FUNCTION (FOR DVD ONLY)

If the DVD has multiple titles recorded on the disc. It can select preferred title from the title menu to start playback.

- Press **TITLE** during playback. The title menu is display.
- Press the cursor button shown in screen display, select preferred title by the cursor button and confirmed by **ENTER** key.

## MULTI-SUBTITLE LANGUAGE FUNCTION (FOR DVD ONLY)

Press **SUBTITLE** during playback. Each time the button is pressed, the subtitle language changes in sequential order.

Notes:

- The language number is different according to the disc.
- Some discs only contain one subtitle language.
- When no different subtitle language are recorded, will be displayed at screen left top corner.

## MULTI-ANGLE FUNCTION (FOR DVD ONLY)

Press **ANGLE** during playback. Each time the button is pressed, the angle changes in sequential order.

Notes:

- The angle number is different according to the disc.
- The function only works for discs having scenes recorded at different angles.
- When no different angle are recorded, will be displayed at screen left top corner.

## MP3 DISC PLAY

MP3 disc is playing as the format of FOLDER.

For example:

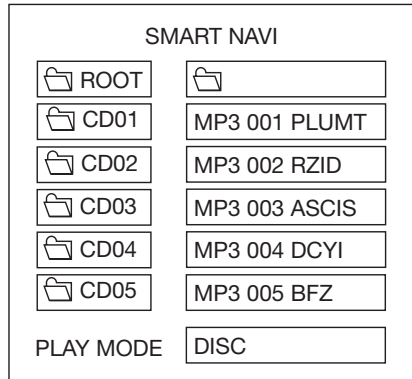

In stop mode, use **▲/▼**, **◀/▶** on the remote control to select the item or folder (such as CD01, CD02...), and press **ENTER** button on the remote control to confirm, then select the desired track (such as 001 PLUMT, 002 RZID...) on the current folder to play.

Pressing **REPEAT** button repeatedly can select three kinds of repeat play mode. REP-ONE:

Play the same song over and again.

FOLDER REP:

Play all songs in the current directory in sequence, over and again.

FOLDER:

Play all songs in the current directory once.

When select PLAY MODE, press **▲/▼** to change between the following mode:

SINGLE → REP-ONE → FOLDER → FOLDER REP →

DISC SCAN → DISC → DISC REP →

SHUFFLE ON → PROGRAM PXXX

In the playback, use **▶▶** or **◀◀** to skip an item ahead or back.

**◀◀** : Rapid reverse, **▶▶** : Rapid advance

Note: The FOLDER cannot be selected during playing. It can be selected after

**■** (Stop) button pressed.

# SETUP

## INITIAL SETUP

SETUP MENU --- MAIN PAGE

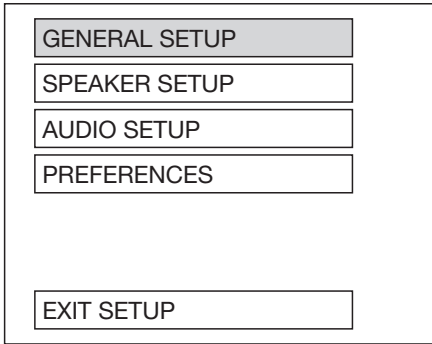

1. Press **SETUP** in the stop mode.  
(Press the stop button twice to ensure the player is in STOP mode.)
2. The initial SETUP menu is displayed.
3. Select the preferred item by using the ▲/▼ buttons.
4. Press ENTER buttons.
  - a. **GENERAL SETUP**  
This setup page includes all the item of TV display & audio output feature. The detail please refer to **GENERAL SETUP MENU**.
  - b. **SPEAKER SETUP**  
This is to activate the audio output from DOLBY AC3 5.1 DOWNMIX to 2 channel mode. Please refer to **SPEAKER SETUP MENU**.
  - c. **AUDIO SETUP**  
This setup page includes all the items for AUDIO. Please refer to **AUDIO SETUP MENU**.
  - d. **PREFERENCE SETUP**  
This setup page includes all the configuration of support feature. The detail please refer to **PREFERENCES SETUP MENU**.

## GENERAL SETUP

--- GENERAL PAGE ---

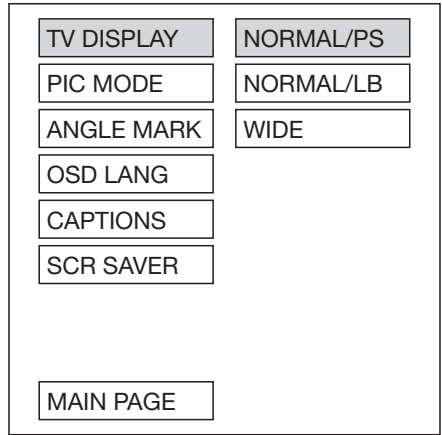

Video Material	TV Screen			
	4:3			Wide (16:9)
	Normal	Pan Scan	Letter-box	
4:3				
16:9				

### TV display setup

This is to select the appropriate TV aspect (4:3 or 16:9) according to the connected TV set.

#### Normal/PS (For 4:3 TV)

Played back in the PAN & SCAN style. (If connected to wide-screen TV, the left and right edges are cut off.)

#### Normal/LB (For 4:3 TV)

Played back in letterbox style. (If connected to wide-screen TV, black bands appear at top and bottom of the screen.)

#### Wide (For 16:9 TV)

Select when a wide-screen TV set is connected.

# SETUP

--- GENERAL PAGE ---

TV DISPLAY	
PIC MODE	AUTO
ANGLE MARK	HI-RES
OSD LANG	N-FLICKER
CAPTIONS	
SCR SAVER	
MAIN PAGE	

## PIC mode setup

Select AUTO, the player PIC mode will depend on DVD disc.  
Select HI-RES format for best image resolution.  
Select N-FLICKER format on format on image or picture under noise affect.

--- GENERAL PAGE ---

TV DISPLAY	
PIC MODE	
ANGLE MARK	
OSD LANG	ENGLISH
CAPTIONS	FRENCH
SCR SAVER	GERMAN
	ITALIAN
	SPANISH
MAIN PAGE	

## OSD LANG type setup

Select the preferred OSD (On Sreen Display) language by using the ▲ / ▼ buttons.

--- GENERAL PAGE ---

TV DISPLAY	
PIC MODE	
ANGLE MARK	ON
OSD LANG	OFF
CAPTIONS	
SCR SAVER	
MAIN PAGE	

## ANGLE MARK display setup

If it is set to ON, when the multi-angle DVD disc is playing, ∞ (the angle mark) will appear on the screen; if it is set to OFF, the mark will not appear.

--- GENERAL PAGE ---

TV DISPLAY	
PIC MODE	
ANGLE MARK	
OSD LANG	
CAPTIONS	ON
SCR SAVER	OFF
MAIN PAGE	

## CAPTIONS setup

Activate the CAPTIONS feature by selecting ON. And deactivate this feature by selecting OFF.

# SETUP

--- GENERAL PAGE ---

TV DISPLAY	
PIC MODE	
ANGLE MARK	
OSD LANG	
CAPTIONS	
SCR SAVER	ON
	OFF
MAIN PAGE	

## SCR SAVER setup

Select the SCR SAVER ON/OFF.

## SPEAKER SETUP

--- SPEAKER SETUP PAGE ---

DOWNMIX	LT/RT
	STEREO
MAIN PAGE	

This is to activate the audio output from DOLBY AC3 5.1 DOWNMIX to 2 channel mode. Select the preferred SPEAKER connection by using the cursor buttons.

- Select the LT/RT to activate the Dolby surround compatible output.
- Select the STEREO to activate simple stereo mode.

## AUDIO SETUP

--- AUDIO SETUP ---

SPDIF	OFF
OP MODE	ON
DYNAMIC	
LPCM OUTPUT	
MAIN PAGE	

## SPDIF

This is to activate the digital audio output on or off.

--- AUDIO SETUP ---

SPDIF	
OP MODE	LINE OUT
DYNAMIC	RF REMOD
LPCM OUTPUT	
MAIN PAGE	

## OP MODE

There are two operating modes for the Dolby Digital decoder: LINE OUT and RF REMOD.

# SETUP

--- AUDIO SETUP ---

SPDIF	
OP MODE	
<b>DYNAMIC</b>	
LPCM OUTPUT	
	FULL
	6/8
	4/8
	2/8
	OFF
MAIN PAGE	

## Dynamic Range Control

Select DYNAMIC and adjust the dynamic range of a Dobyly Digital encoded program. There are 8 steps between full compression and off compression.

--- AUDIO SETUP ---

SPDIF	
OP MODE	
DYNAMIC	
<b>LPCM OUTPUT</b>	LPCM 48K
	LPCM 96K
MAIN PAGE	

## LPCM OUTPUT

Select the LPCM OUTPUT between LPCM 48K and LPCM 96K.

# PREFERENCES SETUP

--- PREFERENCES PAGE ---

TV TYPE	<b>AUTO</b>
AUDIO	NTSC
SUBTITLE	PAL
DISC MENU	
PARENTAL	
PASSWORD	
DEFAULTS	
SMART NAV	
LOGO	
MAIN PAGE	

## TV type setup

This player can play discs recorded in either PAL or NTSC format.

Select NTSC format, when you connected to NTSC TV.

Select PAL format, when you connected to PAL TV.

Select AUTO format, the player TV output format will be according to the DVD disc format.

--- PREFERENCES PAGE ---

TV TYPE	
<b>AUDIO</b>	<b>ENGLISH</b>
SUBTITLE	FRENCH
DISC MENU	SPANISH
PARENTAL	CHINESE
PASSWORD	JAPANESE
DEFAULTS	GERMAN
SMART NAV	ITALIAN
LOGO	
MAIN PAGE	

## AUDIO language setup

Select the preferred AUDIO soundtrack by using the cursor buttons.

# SETUP

--- PREFERENCES PAGE ---

TV TYPE	
AUDIO	
SUBTITLE	ENGLISH
DISC MENU	FRENCH
PARENTAL	SPANISH
PASSWORD	CHINESE
DEFAULTS	JAPANESE
SMART NAV	GERMAN
LOGO	ITALIAN
MAIN PAGE	OFF

## SUBTITLE language setup

Select the preferred SUBTITLE language by using the cursor buttons.

--- PREFERENCES PAGE ---

TV TYPE	1 G
AUDIO	2
SUBTITLE	3 PG
DISC MENU	4 PG 13
PARENTAL	5
PASSWORD	6 PG-R
DEFAULTS	7 NC-17
SMART NAV	8 ADULT
LOGO	NO PARENTAL
MAIN PAGE	

## PARENTAL

Select suitable parental guidance by the cursor buttons and conformed by pressing ENTER button.

--- PREFERENCES PAGE ---

TV TYPE	
AUDIO	
SUBTITLE	
DISC MENU	ENGLISH
PARENTAL	FRENCH
PASSWORD	SPANISH
DEFAULTS	CHINESE
SMART NAV	JAPANESE
LOGO	GERMAN
MAIN PAGE	ITALIAN

## DISC MENU language setup

Select the preferred DISC MENU language by using the cursor buttons.

--- PREFERENCES PAGE ---

TV TYPE	
AUDIO	
SUBTITLE	
DISC MENU	
PARENTAL	
PASSWORD	CHANGE
DEFAULTS	
SMART NAV	
LOGO	
MAIN PAGE	

## PASSWORD

Select CHANGE and press ENTER button. Type the old password (The initial factory code is 3308) and key in 4 characters password now you want to use, and retype again to confirm key in correctly.

# SETUP

--- PREFERENCES PAGE ---

TV TYPE
AUDIO
SUBTITLE
DISC MENU
PARENTAL
PASSWORD
DEFAULTS
SMART NAV
LOGO
MAIN PAGE

RESET
-------

## DEFAULTS

Select reset to become factory initial setting.

--- PREFERENCES PAGE ---

TV TYPE
AUDIO
SUBTITLE
DISC MENU
PARENTAL
PASSWORD
DEFAULTS
SMART NAV
LOGO
MAIN PAGE

ORIG LOGO
CUST LOGO

## LOGO

Select ORIG LOGO (original picture when the unit turns on) or CUSTLOGO (customer-set picture when the unit turns on).

## DEFAULTS TABLE

General Setup	TV Display	Normal/PS
	PIC Mode	AUTO
	Angle Mark	ON
	OSD Language	English
	Captions	OFF
SCR Saver	OFF	
Speaker Setup	Downmix	Stereo
Audio Setup	SPDIF	OFF
	OP Mode	Line Out
	Dynamic	FULL
	LPCM Output	LPCM 96K
Preferences	TV Type	AUTO
	Audio	English
	Subtitle	English
	DISC Menu	English
	Parental	6 PG-R
	Password	3308
	Smart NAV	With Menu
	Logo	Orig Logo

--- PREFERENCES PAGE ---

TV TYPE
AUDIO
SUBTITLE
DISC MENU
PARENTAL
PASSWORD
DEFAULTS
SMART NAV
LOGO
MAIN PAGE

NO MENU
WITH MENU

## SMART NAV

In this item, you can select NO MENU mode or WITH MENU mode.



## **TROUBLE SHOOTING**

---

If it appears that your DVD unit is faulty, first consult this checklist. It may be that something simple has been overlooked.

**Under no circumstances should you try to repair the player yourself, as this will invalidate the warranty. Only qualified service personnel can remove the cover or service this player.**

### **NO POWER**

- Check if the on/off button on the front of the player is set to on.
- Check if AC or DC power plug of the mains unit is properly connected.
- Check if there is power at the AC or DC outlet.

### **NO PICTURE**

- Check if the mode it set to proper state, such as DVD mode and AV mode.
- Check the video connection.

### **DISTORTED PICTURE**

- Check the disc for fingerprints and clean with soft cloth, wiping from centre to edge.
- Sometimes a small amount of picture distortion may appear. This is not a malfunction.

### **COMPLETELY DISTORTED PICTURE**

- The disc format is not according to the TV-set used (PAL/NTSC).

### **NO COLOR IN PICTURE**

- The disc format is not according to the TV-set used (PAL/NTSC).

### **DISC DOES NOT PLAY**

- Ensure the disc label is upwards.
- Clean the disc.
- Check if the disc is defective by trying another disc.

### **NO SOUND**

- Check audio connections.
- If using a HIFI amplifier, try another sound source.

### **DISTORTED SOUND FROM HIFI AMPLIFIER**

- Check to make sure that no audio connections are made to the amplifier phono input.

### **NO RETURN TO START-UP SCREEN WHEN DISC IS REMOVED**

- Press POWER to turn off the unit, then press it again to turn on the unit.

### **THE PLAYER DOES NOT RESPOND TO THE REMOTE CONTROL**

- Aim the remote control directly at the sensor on the front of the player.
- Avoid all obstacles which may interfere with the signal path.
- Inspect or replace the remote control batteries.

### **DISTORTED OR B/W PICTURE**

- The disc format is not according to the TV-set used (PAL/NTSC).

### **NO AUDIO AT DIGITAL OUTPUT**

- Check the digital connections
- Check the Digital Audio menu to make sure that the digital output is correctly set.
- Check if the audio format of the selected audio language matches your receiver's capabilities.

### **BUTTONS DO NOT WORK**

- Turn the player off and on with the power on/off button on the front of the player.

# SPECIFICATIONS

---

Supply Voltage	: 12V DC (11V-15V), test voltage 14.4V, negative ground
Current Consumption	: Less than 2A
Signal System	: Compositive video 1.0Vp-p 75Ω
Discs Played	: (1) DVD-VIDEO Disc 5" (12 cm) single-sided, single-layer 5" (12 cm) single-sided, double-layer (2) Compact Disc (CD-DA/CD-R/CD-RW/MP3) (3) 5" (12cm) VIDEO CD
Audio Output Level	: 10kΩ (2 ch 2.0 Vrms)
Audio Signal Output Characteristics	: (1) Frequency Response 20 Hz - 20 KHz (2) S/N Ratio 80 dB (JIS) (3) Wow and Flutter Below measurable limits

**Note:**

Specifications and design are subject to modification, without notice, due to improvements in technology.

**This product incorporates copyright protection technology that is protected by method claims of certain U.S. patents and other intellectual property rights owned by Macrovision Corporation and other rights owners. Use of this copyright protection technology must be authorized by Macrovision Corporation, and is intended for home and other limited viewing uses only unless otherwise authorized by Macrovision Corporation. Reverse engineering or disassembly is prohibited.**

[www.pyleaudio.com](http://www.pyleaudio.com)



## Free Manuals Download Website

<http://myh66.com>

<http://usermanuals.us>

<http://www.somanuals.com>

<http://www.4manuals.cc>

<http://www.manual-lib.com>

<http://www.404manual.com>

<http://www.luxmanual.com>

<http://aubethermostatmanual.com>

Golf course search by state

<http://golfingnear.com>

Email search by domain

<http://emailbydomain.com>

Auto manuals search

<http://auto.somanuals.com>

TV manuals search

<http://tv.somanuals.com>