

Cat. No. 43-1123 A

## OWNER'S MANUAL

ET-1123

Please read before using this equipment.

# 900 MHz Digital Dual Keypad Cordless Phone

with Speakerphone and  
Caller ID/Call Waiting

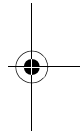
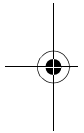

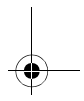
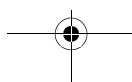
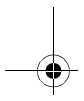

**RadioShack**<sup>®</sup>

[www.radioshack.com](http://www.radioshack.com)<sup>SM</sup>



## FEATURES

**WARNING:** To reduce the risk of fire or shock hazard, do not expose this product to rain or moisture.

	<b>CAUTION</b> RISK OF ELECTRIC SHOCK. DO NOT OPEN.	
<b>CAUTION:</b> TO REDUCE THE RISK OF ELECTRIC SHOCK, DO NOT REMOVE COVER OR BACK. NO USER-SERVICEABLE PARTS INSIDE. REFER SERVICING TO QUALIFIED PERSONNEL.		



This symbol is intended to alert you to the presence of uninsulated dangerous voltage within the product's enclosure that might be of sufficient magnitude to constitute a risk of electric shock. Do not open the product's case.



This symbol is intended to inform you that important operating and maintenance instructions are included in the literature accompanying this product.

Your RadioShack Digital 900 MHz Dual Keypad Cordless Speakerphone operates on the 900 MHz band, which means less interference, clearer sound, and greater range than 46/49 MHz cordless telephones. The Caller ID records each caller's telephone number (and name, if available in your area) and the date and time of the call. If you subscribe to Call Waiting with Caller ID service, your phone shows you the incoming caller information, even when you are already on the phone.

Your phone's features include:

**Dual Keypad** — let you use the keypad on the base or on the handset to make and answer calls or program the phone's features.

**Speakerphone** — lets you hold a conversation handsfree from the base intercom speaker.

**30-Number Memory Dialing** — lets you store 30 numbers in memory (20 in the handset, 10 in the base) for easy dialing.

**4 One-Touch Speed Dial Memory** — lets you store four numbers on the base for one-touch dialing.

**Caller ID Memory** — stores up to 50 Caller ID records on the handset.

**Dual Liquid Crystal Displays** — lets you view an entire Caller ID record on the handset or base display.

© 2000 RadioShack Corporation.  
All Rights Reserved.

RadioShack and COM-LOK are registered trademarks used by RadioShack Corporation.

**Two-Way Intercom/Paging System** — lets you send a signal from the base to the handset, or from the handset to the base, to locate the handset or page someone using it away from the base. If someone answers the page, you can use the phone as an intercom and speak to the person on the handset.

**30 Channels** — automatically selects a clear channel when you make or answer a call. You can also manually change channels during a call.

**Headset Jack** — lets you connect an optional headset for handsfree convenience.

**Volume Controls** — let you adjust the volume you hear through the handset and speakerphone.

**Ringer Volume Control** — lets you select from four ringer tone/volume settings on the handset.

**Security Access-Protection Code** — helps prevent other cordless phone users from using your phone line while the handset is off the base.

**COM-LOK** — ensures that other cordless phone users cannot use your phone line when the handset is on the base.

**Long Battery Life** — the supplied battery pack (when fully charged) provides about 7 hours of talk time or 7 days of standby time.

**Tone/Pulse Dialing** — lets you use either type of service, and you can easily

switch from pulse to tone dialing for long-distance, bank-by-phone, or other special services.

**Redial** — lets you quickly redial any of the last three numbers dialed on the handset. You can also redial the last number you dialed on the base.

**Auto Talk** — you can set the phone so you can answer a call simply by lifting the handset from the base.

**Any Key Answer** — you can set the phone so you can press any key to answer a call when the handset is away from the base.

**Hearing-Aid Compatibility** — lets you use your phone with hearing aids that have a T (telephone) switch.

**Facedown/Faceup Handset Charging** — you can charge the handset on the base facedown or faceup.

**Wall Mountable** — you can mount the phone base on a wall to save space on your desktop.

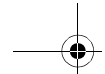

### Important Caller ID Information

To use the phone's Caller ID and Caller ID with Call Waiting features, you must be in an area where those services are available and you must subscribe to those services through your local phone company.

Where Caller ID is offered, one or more options are generally available:

- caller's number only
- caller's name only
- caller's name and number

### READ THIS BEFORE INSTALLATION

We have designed your phone to conform to federal regulations, and you can connect it to most telephone lines. However, each device that you connect to the phone line draws power from the phone line. We refer to this power draw as the device's ringer equivalence number, or REN. The REN is on the bottom of the base. If you are using more than one phone or other device on the line, add up all the RENs. If the total is more than five (three in rural areas), your phones might not ring. If ringer operation is impaired, remove a device from the line.

### FCC STATEMENT

Your phone complies with Part 68 of FCC Rules. You must, upon request, provide the FCC registration number and the REN to your phone company. These numbers are on the bottom of the base.

You must not connect your phone to any of the following:

- coin-operated systems
- party-line systems
- most electronic key phone systems

**Note:** Your telephone operates on standard radio frequencies, as allocated by the FCC. Even though the security access-protection code prevents unauthorized use of your phone line, it is possible for radios operating on similar frequencies within a certain area to unintentionally intercept your conversations and/or cause interference. This lack of privacy can occur with any cordless phone.

# CONTENTS

---

<b>Preparation .....</b>	<b>6</b>
Mounting the Phone .....	6
Connecting and Charging the Battery Pack .....	8
Setting the Dialing Mode .....	9
Turning the Base Ringer On/Off .....	10
Setting the Handset's Ringer Tone/Volume .....	10
Setting Auto Talk .....	10
Turning Caller ID/Call Waiting On/Off .....	10
Storing Your Area Code .....	11
<b>Operation .....</b>	<b>12</b>
Making a Call .....	12
Receiving a Call .....	12
Adjusting the Handset Volume .....	13
Selecting the Channel .....	13
Using Mute .....	13
Switching Between the Handset and the Speakerphone .....	13
Using Both the Handset and the Speakerphone .....	14
Using Flash .....	14
Using Redial .....	14
Using Tone Services On a Pulse Line .....	14
Using Page/Intercom .....	15
Transferring a Call Between the Handset and the Base .....	15
Out of Range .....	16
Using a Headset .....	16
Memory Dialing .....	17
Caller ID Operation .....	20
<b>Troubleshooting .....</b>	<b>23</b>
<b>Care and Maintenance .....</b>	<b>25</b>
Replacing the Battery Pack .....	26
The FCC Wants You to Know .....	27
Lightning .....	27

## PREPARATION

**Note:** The base unit display is protected during shipment by a piece of clear film. Carefully peel off this film before using your phone for the first time.

## MOUNTING THE PHONE

You can place the phone's base on a desk or table, mount it on a standard wall plate, or mount it directly on a wall. Choose a location that is:

- near an AC outlet
- near a modular telephone line jack
- out of the way of normal activities
- away from electrical machinery, electrical appliances, metal walls or filing cabinets, wireless intercoms, alarms, and room monitors
- away from other cordless phones

The base's location affects the phone's range. If you have a choice of several locations, try each to see which provides the best performance.

**Caution:** The supplied RadioShack adapter was designed specifically for your phone. Use only the supplied adapter.

### Notes:

- Your telephone connects directly to a modular telephone line jack. If your phone line jack is not a modular jack, you can update the wiring yourself, using jacks and adapters available at your local RadioShack

store. Or, you can let the phone company update the wiring for you.

- The USOC number of the jack to be installed is RJ11C (RJ11W for a wall plate).

### On a Desk Top

1. Plug one end of the supplied long modular cord into the **TEL LINE** jack on the back of the base.

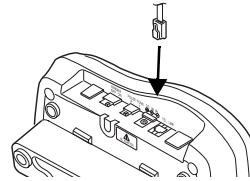

2. Plug the modular cord's other end into a modular telephone line jack.
3. Insert the supplied AC adapter's barrel plug into the **DC IN 9V** jack on the back of the base.

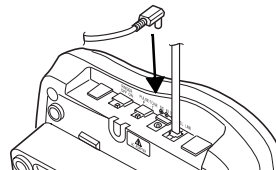

4. Route the adapter's cord through the strain relief slot on the bottom of the base.

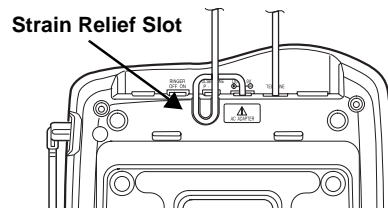

5. Plug the adapter into a standard AC outlet.
6. Lift the base's antenna to a vertical position.

in Step 3 of "On a Desk Top" on Page 7.

5. Route the adapter and modular cords through the grooves on the bracket.

### On a Wall Plate

1. Detach the stand from the base by pressing the latches on the stand.

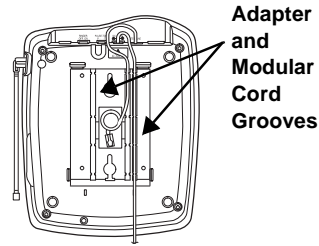
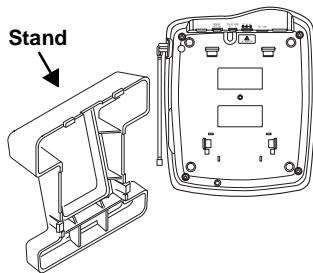

6. Plug the modular cord's other end into the wall plate jack, then align the bracket's keyhole slots with the wall plate studs and slide the base downward to secure it.

2. Insert the two tabs at the top of the narrow end of the supplied bracket into the base's upper tab slots as shown, then press down on the bracket's latches and insert them into the lower slots.

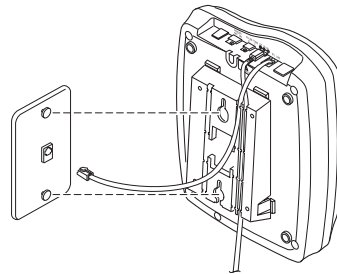
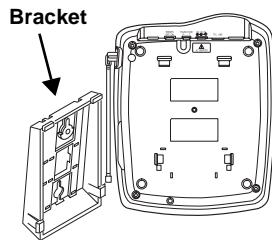

3. Plug one end of the supplied short modular cord into the **TEL LINE** jack on the back of the base as in Step 1 of "On a Desk Top" on Page 6.
4. Insert the supplied AC adapter's barrel plug into the **DC IN 9V** jack as

7. Plug the adapter into a standard AC outlet.
8. Press and lift out the handset holder, flip it over as shown, then snap it back into place so it holds the handset.

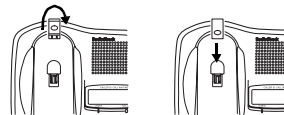

9. Lift the base's antenna to a vertical position.

## On a Wall

To mount the phone directly on a wall, you need two screws (not supplied) with heads that fit into the keyhole slots on the bottom of the base. Follow the steps under "On a Wall Plate" on Page 7, then apply these additional instructions for placement on a wall.

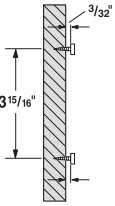
1. Drill two holes  $3^{15}/16$  inches (100 mm) apart. Then thread a screw into each hole, letting the heads extend about  $5/16$  inch (8 mm) from the wall. 
2. Plug one end of the supplied long modular cord into the **TEL LINE** jack at the back of the base.
3. Align the bracket's keyhole slots with the mounting screws and slide the base downward to secure it.

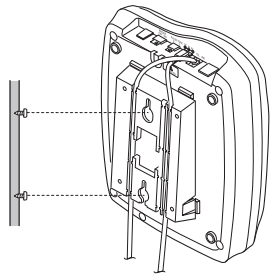

## CONNECTING AND CHARGING THE BATTERY PACK

The phone comes with a rechargeable nickel-cadmium battery pack installed in the handset, but not connected. Before using your phone, you must connect the battery pack, then charge it for about 24 hours.

1. Press down and slide off the battery pack compartment cover.

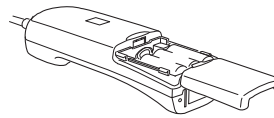

2. Lift the battery pack out of the compartment. Plug the battery pack's connector into the socket in the compartment. The connector fits only one way.

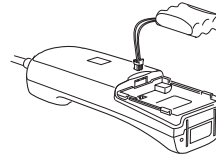

3. Put the battery pack in the compartment.
4. Replace the cover.

To charge the battery pack, simply place the handset on the base, facing either up or down. The **CHARGE/IN USE** indicator on the base lights.

Recharge the battery pack when **Low Battery** flashes on the handset's display.



**Important:** Be sure the battery pack is properly connected before you try to charge it.

**Notes:**

- When you first use the phone after charging or recharging the battery pack, the phone might not work and you might hear a five-beep error signal. If this happens, return the handset to the base for about 5 seconds. This resets the security access-protection code.
- Using a pencil eraser, clean the charging contacts on the handset and the base about once a month.

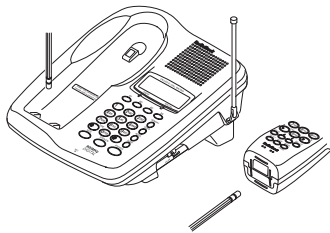

- If the handset's display is blank and the phone does not work, recharge the battery pack. (The battery power might be too low to light the display.)
- If the battery pack becomes weak during a call, the handset beeps every 3 seconds and **Low Battery** flashes. When this happens, you cannot make another call on the phone until you recharge the battery pack.
- About once a month, fully discharge the battery pack by keeping the handset off the base until **Low Battery** flashes. Otherwise, the

battery pack loses its ability to fully recharge.

- If the battery pack is completely discharged or the base loses power while the handset is away from it, place the handset on the base to reset the security access-protection code. If it was the handset that lost power, recharge the battery pack.
- The supplied battery pack should last about a year. When it loses its ability to fully recharge, order a replacement battery pack through your local RadioShack store (see "Replacing the Battery Pack" on Page 26).

## SETTING THE DIALING MODE

Set **DIAL MODE P- -T** on the back of the base for the type of service you have. If you are not sure which type you have, after you charge the handset battery pack, do this simple test.

1. Set **DIAL MODE P- -T** to **-T**.
2. Press **SPEAKER** and listen for a dial tone.
3. Press any number other than **0** on the base's keypad.

**Note:** If your phone system requires that you dial an access code (9, for example) before you dial an outside number, do not press the access code number either.

If the dial tone stops, you have touch-tone service. Leave **DIAL MODE P- -T** set to **-T**. If the dial tone continues, you have pulse service. Set **DIAL MODE P- -T** to **P-**.

4. Press **SPEAKER** to hang up.

## TURNING THE BASE RINGER ON/OFF

To turn off the base's ringer, set **RINGER** on the back of the base to **OFF**. You can still make or receive calls using this phone. Telephones on the same line (and the phone's handset if it is away from the base) still ring when there is an incoming call.

To turn on the base's ringer, set **RINGER** to **ON**.

## SETTING THE HANDSET'S RINGER TONE/VOLUME

You can select one of four different ringer tone/volume settings while the phone is not in use. Press **▲** or **▼** on the handset to increase or decrease to the ringer level setting. Repeatedly press **▲** or **▼** until you hear the desired ringer setting. Each time you press **▲** or **▼**, the ringer changes and the display shows **Ringer A High**, **Ringer A Low**, **Ringer B High**, or **Ringer B Low**.

**Note:** Pressing **▲** when the display shows **Ringer A High** or **▼** when the display shows **Ringer B Low** does not

change the setting. Press the other button to change the setting.

## SETTING AUTO TALK

Your phone is preset so you must press **TALK** to answer a call. With auto talk turned on, you can answer a call by just lifting the handset from the base, or, if the handset is away from the base, by pressing any key.

Follow these steps to turn auto talk on or off.

1. Lift the handset and hold down **CALL ID** until the Caller ID setup menu appears with **Auto Talk** selected.
2. Press **SELECT** to change the auto talk setting. **On** or **Off** appears indicating the selected setting.
3. Press **CALL ID** or return the handset to the base to store the new setting.

## TURNING CALLER ID/ CALL WAITING ON/OFF

If you have Call Waiting with Caller ID service, you can set the phone to show Caller ID information for an incoming call even while you are already on the phone.

Follow these steps to turn the Caller ID/ Call Waiting feature on or off.

1. Lift the handset and hold down **CALL ID** until Caller ID setup menu appears with **Auto Talk** selected.
  2. Press **2** or **▼** to select **CIDCW** (Caller ID/Call Waiting).
  3. Press **SELECT** to change the Caller ID/Call Waiting setting. **On** or **Off** appears indicating the selected setting.
  4. Press **CALL ID** then return the handset to the base to store the new setting.
4. Press **SELECT**, then press **CALL ID** and return the handset to the base cradle to store the new setting.

**Note:** In some areas, the area code is necessary even for a local call. If you live in such an area, do not enter the area code.

## STORING YOUR AREA CODE

By storing your local area code in the phone's memory, the area code does not appear in the Caller ID record display if it matches the one you stored.

Follow these steps to store your area code.

1. Lift the handset and hold down **CALL ID** until Caller ID setup menu appears with **Auto Talk** selected.
2. Press **3** (or **▼** twice) to select **Area Code**.
3. Press **SELECT**, then enter your 3-digit area code. If you make a mistake, repeatedly press **◀** or **▶** to move the cursor over the incorrect digit, then enter the correct number.

**Note:** If an area code is already stored, it appears on the display. To delete the area code, press **DEL/CH** three times. Then enter your new area code.

## OPERATION

---

**Note:** To use the speakerphone, you must use the base keypad; to use the handset, you must use the handset keypad.

### MAKING A CALL

#### Using the Handset

To make a call, lift the handset and press **TALK**. **Talk** appears on the handset's display and **Handset in Use** appears on the base's display and CHARGE/IN USE lights. Dial the number. You see the number as you dial, then (after a few seconds) the call's elapsed time.

**Note:** You can also dial the number before you press **TALK**. If you make a mistake, repeatedly press **DEL/CH** to erase each digit up to the wrong entry, then enter the correct number. You can also press and hold **DEL/CH** for more than one second to delete the entire number.

To end a call, place the handset on the base or press **TALK**.

#### Using the Speakerphone

To make or answer a call using the speakerphone, simply press **SPEAKER**. **SP-Phone** appears on the base's display. Use the base's keypad to dial the number. You see the number as you dial, then (after a few seconds) the call's elapsed time.

**Note:** You can also dial the number before you press **SPEAKER**. If you make a mistake, repeatedly press **CLEAR** to erase each digit up to the wrong entry, then enter the correct number. You can also press and hold **CLEAR** for more than one second to delete the entire number.

To adjust the speakerphone's volume, adjust **VOLUME** on the side of the base.

To end a speakerphone call, press **SPEAKER** again.

### RECEIVING A CALL

When the phone receives a call, **Incoming Call** appears. If you subscribe to Caller ID service from your telephone company, the phone company sends information about the call, as well as time and date, between the first and second rings of every call you receive.

#### Notes:

- The base's display shows the number and name (if available). The handset's display shows the date, time, and number of calls received from same caller in addition to the number and name.
- For the details of the Caller ID message, see "Caller ID Messages" on Page 21.

To answer the call using the handset, lift the handset off the base and press **TALK**. If auto talk is on, just lift the handset or press any key on the handset. To answer a call using the speakerphone, simply press **SPEAKER**.

## ADJUSTING THE HANDSET VOLUME

To adjust the volume you hear through the handset during a call, press **▲** to increase or **▼** to decrease the volume. The display shows **Volume Maximum**, **Volume High**, **Volume Medium**, or **Volume Low**.

**Note:** If you press **▲** while the volume is at the maximum or press **▼** while the volume is low, the setting does not change.

## SELECTING THE CHANNEL

The phone scans 30 channels (frequency pairs used between the base and the handset) and automatically selects a clear channel each time you make or receive a call. If you hear other conversations or excessive noise during a call, press **DEL/CH** to select a different channel. The display shows **Scanning**.

**Note:** If the handset is too far from the base, the channel might not change and you hear an error beep. Move closer to the base and try again.

## USING MUTE

To talk to someone in the room while using the speakerphone without the person on the other end of the phone line hearing your conversation, press **MUTE**. **MUTE** appears on the base's display.

Press **MUTE** again to resume your phone conversation.

**Hint:** When you talk over the speakerphone, the party that speaks first has priority. If you are making a call in a noisy environment, the phone might pick up the noise and assume you are still communicating, thus not switching back to the person you are speaking with. If this should happen, press **MUTE** so the noise will not be picked up by the phone's microphone. Press **MUTE** again to release when it is your turn to speak.

## SWITCHING BETWEEN THE HANDSET AND THE SPEAKERPHONE

To switch to the speakerphone while you are using the handset, press **SPEAKER** on the base. When you hear the conversation on the speakerphone, press **TALK** on the handset.

To switch to the handset while you are using the speakerphone, lift the handset off the base. If the handset is away from the base, press **TALK**, then press **SPEAKER**.

## USING BOTH THE HANDSET AND THE SPEAKERPHONE

If someone else is using the speakerphone, press **TALK** on the handset to join the conversation. If someone else is using the handset, press **SPEAKER** on the base to join the conversation. **Conference** appears on the base's display and CHARGE/IN USE lights.

During the call, one person can hang up and let the call continue at the other keypad. Or, both people can hang up to end the call.

**Note:** If you hear a high-pitched noise from the base's speaker, the handset and the base are too close together.

## USING FLASH

Flash performs the electronic equivalent of a switchhook operation for special services, such as Call Waiting. For example, if you have Call Waiting, press **FLASH** to answer an incoming call without disconnecting the current call. Press **FLASH** again to return to the first call.

**Note:** If you do not have any special phone services, pressing **FLASH** might disconnect the current call.

## USING REDIAL

To quickly dial any of the last three numbers dialed on the handset, lift the hand-

set and press **REDIAL/PAUSE**. The last number dialed on the handset appears below **<Redial 1>**. Press **REDIAL/PAUSE** repeatedly until the desired number appears on the display, then press **TALK**.

To dial the last number dialed on the base, press **REDIAL** on the base. The last number dialed on the base appears on the base's display. Then press **SPEAKER**. You can redial only the last number on the base.

### Notes:

- The redial memory is separate for each keypad. You cannot redial a number you dialed on the handset keypad using **REDIAL** on the base, and vice versa.
- The redial memory holds up to 32 digits, so you can redial any long-distance number as well as local numbers.
- The redial memory also holds pause entries (see "Entering a Pause" on Page 19).

## USING TONE SERVICES ON A PULSE LINE

Some special services, such as bank-by-phone, require tone signals. If you have pulse service, you can still use these special tone services by following these steps.

1. Be sure **DIAL MODE P- -T** is set to **P-**.

2. Dial the service's main number.
3. When the service answers, press **-tone/**. Any additional numbers you dial are sent as tone signals.
4. When you hang up, the phone automatically resets to pulse dialing.

## USING PAGE/INTERCOM

You can use the phone as a two-way pager and intercom between the base and the handset. This is useful if the handset is away from the base and you want to locate it, or if you want to have a conversation between someone with the handset and someone at the base.

*To page the base from the handset,* press **INTCM**. The base and handset ring. **Paging** appears on the base's display and **Paging Base** appears on the handset's display. Press **SPEAKER** or **INTERCOM** on the base to answer the page. Both displays change to **Intercom**.

*To page the handset from the base,* press **INTERCOM**. The handset and base ring. **Paging Handset** appears on the base's display and **Paging** appears on the handset's display. Press **TALK** or **INTCM** on the handset to answer the page. Both displays change to Intercom.

In either case, if the called party does not answer within 1 minute, the paging stops. Press **INTCM** or **INTERCOM** again to restart paging.

To end an intercom call, press **TALK** on the handset, press **SPEAKER** on the base, or hang up the handset.

If a call comes in during an intercom conversation, only the base rings, but the person at the handset can also hear the ring through the intercom. Either person can answer the call by pressing **TALK** or **SPEAKER** once to end the intercom call, then pressing **TALK** or **SPEAKER** again to answer the call.

**Note:** The intercom does not operate if the party being paged is already on a call.

## TRANSFERRING A CALL BETWEEN THE HANDSET AND THE BASE

You can use the phone's intercom feature to transfer a call between the handset and the base for a three-way conversation.

To transfer a call from the handset to the base, press **INTCM**. The call is placed on hold, **CHARGE/IN USE** blinks, and **Hold** and **Paging Base** appear on the handset's display. When the person at the base answers, press **TALK**. The call is released from hold and transferred to the base. To bring the handset back into the conversation for a three-way conference, press **TALK** again.

To transfer a call from the base to the handset, press **INTERCOM**. The call is placed on hold, **CHARGE/IN USE** blinks, and **Hold** and **Paging Handset** appear on the base's display. When the person with the handset answers, press **SPEAKER**. The call is released from hold and transferred to the handset and the display changes to **Handset in Use**. To bring the base back into the conversation for a three-way conference, press **SPEAKER** again.

## OUT OF RANGE

If you have the handset out of the base's range while a call is in progress, noise increases. Return to the base's range within 30 seconds, then you can resume your phone conversation.

If you keep the handset out of the base's range for 30 seconds or more, the call is disconnected. However if you are in 3-way conference call, the speakerphone call remains connected.

## USING A HEADSET

You can talk with handsfree convenience using an optional headset that has a  $\frac{3}{32}$ -inch (2.5-mm) plug. Your local RadioShack store has a variety of suitable headsets to choose from.

To connect the headset, open the rubber cover marked  $\cup$  on the side of the handset, then insert the headset's plug into the jack.

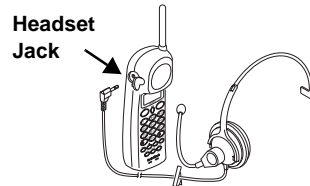

### Notes:

- Connecting a headset disconnects the handset's earpiece and microphone.
- $\blacktriangle$  or  $\blacktriangledown$  on the handset also controls the connected headset's volume, but maximum setting is not available on the headset.
- If you place the handset on the base to recharge it while the headset is connected, be sure the handset seats properly.

With a headset connected, you can make or answer calls as usual using the keys on the handset. You can also make or answer calls by pressing the **SPEAKER** button located on the base.

You can use a handset holder (available from your local RadioShack store) to hang the handset on your belt for greater convenience.

When you finish using the headset, disconnect it from the handset and close the rubber cover to protect the jack.



## MEMORY DIALING

You can store up to 20 numbers in the handset's memory and another 10 in the base's memory, then dial a stored number by pressing a memory location number. You can also store a name with each number in the handset's memory. The base has four one-touch dial memories in addition.

Each number you store can be up to 20 digits long, and each name can be up to 13 characters.

You cannot dial a number stored in one memory location (the base or the handset) using the keypad on the other.

### Storing a Name and Number in Memory

#### Notes:

- An error tone sounds and the phone exits the storing process if you wait more than 20 seconds between key presses.
- If you receive a call during memory entry, the phone exits the storing process.

To store a name and number in the *handset*, follow these steps:

1. Lift the handset.
2. Hold down **MEM** until **Memory Store** and a list of memory location numbers (and names, if any) appear.

3. Select an empty memory location (or the one you want to replace) by using **▲** or **▼** to scroll through the list or entering the location number (**01-20**). Precede a single-digit number with a **0** (**01**, for example).

#### Notes:

- If the phone sounds five quick beeps, you have made an entry error and the number was not stored. Re-enter the location number correctly.
4. Press **SELECT**. **Store Name** appears.
    - If you do not want to enter a name, skip to Step 6.
  5. To enter a name, use **▲** or **▼** to select the characters and **◀** or **▶** to move the cursor to the next character space. Repeatedly press **▼** to view the characters in alphabetical order. The display shows uppercase letters first, then lowercase letters, numbers, and special characters. Press **▲** to view the characters in reverse order. You can hold down **▲** or **▼** to scroll rapidly through the characters.

If you make a mistake, move the cursor over the error, then enter the correct character, or press **DEL/CH** to delete a character. To delete all the characters, hold down **DEL/CH** for at least 1 second.

6. Press **SELECT**. **Store Number** appears.

7. Enter the phone number and any tone or pause entries (see "Entering a Pause" on Page 19).

If you make a mistake, use the same method to correct it as described in Step 5.

8. Press **SELECT**. The phone beeps and **Memory nn Stored** (*nn* stands for the memory location number you assigned) appears. After 2 seconds, **Memory Store** appears. Repeat Steps 3-8 to store more numbers.

9. When you finish, press **MEM**.

To replace a stored number, store a new one in its place using the same steps above.

To store number in the **base**, follow these steps:

1. Hold down **MEMORY** until **Store Number** appears on the base's display.

2. Enter the phone number and any tone or pause entries (see "Entering a Pause" on Page 19).

If you make a mistake, press **CLEAR** to exit the memory store operation. Start again at Step 1.

3. Press **MEMORY** again. **Location No.** appears. Enter the memory location number (0-9) or the one-touch dial button (M1-M4) where you want to store the number. A tone sounds and **Memory n Stored** or **Memory Mn Stored** appears on the display to indicate that the number is stored.

To clear a stored number, simply store a new number in its place. Or, hold down **MEMORY** until **Store Number** appears. Then press **MEMORY** and the memory location number (0-9) or the one-touch dial button (M1-M4) you want to clear. A tone sounds and **Memory n Stored** or **Memory Mn stored** appears on the display.

Use the supplied memory directory sticker to record your stored numbers. Peel the backing from the sticker and attach it to the base.

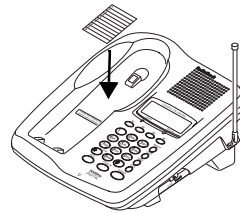

### Editing or Deleting a Number in the Handset's Memory

Follow these steps to edit or delete a memory number.

1. Lift the handset.
2. Hold down **MEM** until **Memory Store** and a list of memory location numbers appear on the display.
3. Choose a memory location (01-20) by pressing a number or by repeatedly pressing **▲** or **▼**.
4. Press **SELECT**. A menu appears with the three options listed below. Press **▲** or **▼** to highlight the desired option then press **SELECT** to choose it.

### Menu Options:

- **Edit Memory nn** — edit the record as described in Steps 5 through 8 of “Storing a Name and Number in Memory” on Page 17.
- **Delete Memory nn** — the display prompts you to confirm the deletion. Move the cursor to **Yes**, then press **SELECT** or **DEL/CH**. The phone beeps, and **Memory nn Deleted** appears.
- **Go Back** — returns you to the list of memory numbers.

### Entering a Pause

In some telephone systems, you must dial an access code (9, for example) and wait for a second dial tone before you can dial an outside number. You can store the access code with the phone number. However, you should also store a pause after the access code to allow the outside line time to connect.

To enter a 2-second pause, press **REDIAL/PAUSE** (**REDIAL** on the base). **P** appears on the display when you enter a pause in the memory. You can add more pause entries for a longer pause.

### Reviewing Memory Numbers (Handset Only)

To review your memory numbers, press **MEM**. The list of memory location numbers (01-20) and the name stored with each number (or **<Memory nn>** if you did not store a name) appears. To view several a memory location, press its

number (01-20) or repeatedly press **▲** or **▼**.

To see the stored phone numbers, press **▶**. An arrow to the right of the number means it is longer than 14 digits. Press **▶** again to see the rest of the number.

Repeatedly press **◀** to return to the name display.

To exit the memory number list, press **MEM**.

To see a stored name and phone number at the same time, press **SELECT** when the cursor is by a memory location number. To exit this display, hold down **DEL/CH** until the display clears.

### Dialing a Memory Number

To dial a number stored in handset memory, lift the handset and press **MEM**. The list of memory location numbers appears. Choose a memory location (01-20) by pressing a number or by repeatedly pressing **▲** or **▼**, then press **TALK**.

You can also dial a memory number after pressing **TALK**. Press **MEM** (the display does not change but the phone is in memory recall mode) then enter a memory location number.

To dial a number stored in the base's memory, press **MEMORY**. **Location No.** appears. Press a number key (0-9); the display shows the number contained in the selected memory location. Press **SPEAKER** to dial the number on the display.

**Note:** If you select an empty memory location, no number appears.

To dial a number stored in one-touch dial memory, simply press the button (**M1-M4**). You do not need to press **SPEAKER** to dial the number in one-touch dial memory.

**Note:** If you select an empty one-touch dial memory, the base beeps five error beeps.

### Chain-Dialing Service Numbers

For quick recall of numbers for special services (such as bank by phone), store each group of numbers in its own memory location. Dial the service's main number first. Then, at the appropriate place in the call, press **MEM** (or **MEMORY** on the base) and enter the number for the location where the additional information is stored.

### Testing Stored Emergency Numbers

If you store an emergency service's number (police department, fire department, ambulance) and you choose to test the stored number, make the test call during the late evening or early morning hours to avoid peak demand periods. Also, remain on the line to explain the reason for your call.

## CALLER ID OPERATION

If you subscribe to Caller ID service from your phone company, the phone company sends information about the call, as well as the time and date, between the first and second rings of every call you receive. This information appears after the second ring on both the handset's and the base's displays. The display also shows if caller information is unavailable or if the name and number were blocked by the caller (see "Caller ID Messages" on Page 21).

If you subscribe to Call Waiting with Caller ID, you will hear a tone through the handset when a call comes in, then the Caller ID record appears. If you want to answer the incoming call, press **FLASH**. To resume the previous phone conversation, press **FLASH** again.

The handset has Caller ID memory to store the information received up to 50 Caller ID records for later review. It stores the information even when you answer the call using the speakerphone.

If the Caller ID memory becomes full, any new call replaces the oldest call's record.

The base's **NEW CALL** indicator also flashes when the phone receives a call with Caller ID information and you have not yet reviewed it. Use the handset's Caller ID memory to review the information about the call(s) received.

## Reviewing Caller ID Records (Handset Only)

To review the Caller ID records in the handset's memory, lift the handset and press **CALL ID**. The number of new Caller ID records, if any, and the total number of records appears.

**Note:** If the handset is faceup on the base, it shows the number of Caller ID records, so you can see if you have new records to review.

Repeatedly press ▼ to scroll through the Caller ID records from the newest to the oldest, or ▲ to scroll back through the records. To scroll quickly through the records, hold down ▲ or ▼.

When you scroll past the last record, **End** appears. When you scroll past the first record, the record totals appear.

The top line of each record shows the date, time and the number of calls from that number. The second line shows the caller's name, and the third line shows the caller's phone number.

**Note:** Calls cannot be reviewed or stored in the base.

## Caller ID Messages

Display	Description
<b>New: XX</b> <b>Total: XX</b>	Shows the number of new Caller ID records (records you have not reviewed) and the total number of records.
<b>Private Name</b> or <b>Private Number</b>	The caller has blocked the Caller ID information from being sent.
<b>Unknown Name</b> or <b>Unknown Number</b>	The caller is not within a Caller ID service.
<b>Incomplete Data</b>	Appears if there was an error during the transmission of Caller ID information. Minor electrical disturbances can affect Caller ID information. Occasional errors are normal. If the phone frequently displays Incomplete Data, contact your local telephone company or RadioShack store for assistance.
<b>End</b>	Appears when you scroll past the oldest Caller ID record.

## Dialing Numbers From a Caller ID Record (Handset Only)

To dial a local number stored in a Caller ID record, recall the record, then press **TALK**. If it is a long distance call, press **1** before you press **TALK**.

**Note:** If a Caller ID record does not contain a phone number (if it was blocked by the caller, for example) you cannot dial from that record.

### Storing a Caller ID Record to Memory (Handset Only)

To store the name and number from a Caller ID record into a handset's memory location, recall the record you want to store. Press **MEM**, then **Select Location** appears.

Choose a memory location (**01-20**) by pressing a number or by repeatedly pressing **▲** or **▼**, then press **SELECT**.

If the selected location is empty, the phone beeps to confirm that it stored the number, then the Caller ID record appears. If a record exists in the selected location, **Replace Memory?** appears, prompting you to confirm the replacement. Move the cursor to **Yes** or **No**, then press **SELECT**.

### Deleting Caller ID Records (Handset Only)

You can delete Caller ID records individually or all at once.

To delete a single record, recall it, then press **DEL/CH**. **Delete Message?** appears, prompting you to confirm the deletion. Move the cursor to **Yes**, then press **SELECT** or **DEL/CH**.

To delete all the records at once, press **CALL ID** so the record totals appear, then press **DEL/CH**. **Delete All?** appears, prompting you to confirm the deletion. Move the cursor to **Yes**, then press **SELECT** or **DEL/CH**.

## TROUBLESHOOTING

We do not expect you to have any problems with your phone, but if you do, these suggestions might help.

Problem	Suggestion
Low volume or unusual sounds.	Someone has picked up another phone on the same line. Hang up the other phone.
Severe noise interference.	Press DEL/CH to change the channel.
	Keep the handset away from computers, remote control toys, wireless microphones, alarm systems, intercoms, room monitors, fluorescent lights, and electrical appliances.
	Move the handset to another location or turn off the source of interference.
The phone cannot be operated at a useful distance from the base because the signal becomes weak or noisy (handset's range has decreased).	Lift the base's antenna to a vertical position.
	Be sure neither antenna is touching a metal surface.
	Return the handset to the cradle, and recharge the battery pack.
	Replace the battery pack if necessary (see "Replacing the Battery Pack" on Page 26).
The phone does not work or works poorly.	Be sure the base's phone line cord and AC adapter are correctly and securely connected, and the battery pack is charged.
The handset battery pack does not charge.	Check the charging contacts on the handset and base. If they are dirty, clean them with a pencil eraser.
	Be sure the battery pack is connected correctly.
	Replace the battery pack.
The handset does not ring or receive a page.	Move the handset closer to the base.
	Lift the base's antenna to a vertical position.
	Be sure the battery pack is charged. (If the battery power is too low, it does not have enough power to light the display.)
The handset does not ring or receive a page.	Move the base away from other electrical devices and sources of noise.

Problem	Suggestion
The handset stops working or works poorly during a call.	Move the handset closer to the base.
	Lift the base's antenna to a vertical position.
	Be sure the battery pack is charged. (If the battery power is too low, it does not have enough power to light the display.)
	If the base loses power while the handset is away, the security access-protection code might change. Restore power to the base, then place the handset back on the base. The CHARGE/IN USE indicator lights, indicating that the code is set again.
<b>Low Battery</b> flashes on the display every few seconds.	Be sure the battery pack is correctly connected.
You have an incoming call, but do not receive any Caller ID information.	Let the phone ring twice before you answer so the system has time to record the Caller ID information.
	Check that the system is correctly and securely connected.
	Call your phone company to verify that your Caller ID service is active.

If you still have problems, disconnect the phone. If other phones on the same line work properly, the fault is in this phone or its installation. If you cannot find the problem, take your phone to your local RadioShack store for assistance.



## CARE AND MAINTENANCE

---

Your RadioShack Digital 900 MHz Dual Keypad Cordless Speakerphone is an example of superior design and craftsmanship. The following suggestions will help you care for your phone so you can enjoy it for years.



Keep the phone dry. If it gets wet, wipe it dry immediately. Liquids might contain minerals that can corrode the electronic circuits.



Use and store the phone only in normal temperature environments. Temperature extremes can shorten the life of electronic devices, damage batteries, and distort or melt plastic parts.



Keep the phone away from dust and dirt, which can cause premature wear of parts.



Handle the phone gently and carefully. Dropping it can damage circuit boards and cases and can cause the phone to work improperly.



Use only fresh batteries of the required size and recommended type. Batteries can leak chemicals that damage your phone's electronic parts.



Wipe the phone base and handset with a damp cloth occasionally to keep them looking new. Do not use harsh chemicals, cleaning solvents, or strong detergents to clean the phone.

Modifying or tampering with the phone's internal components can cause a malfunction and might invalidate its warranty and void your FCC authorization to operate it. If your phone is not performing as it should, take it to your local RadioShack store for assistance. If the trouble is affecting the telephone lines, the phone company can ask you to disconnect your phone until you have resolved the problem.

## REPLACING THE BATTERY PACK

If you follow the instructions in "Connecting and Charging the Battery Pack" on Page 8, the battery pack should last about one year. If the battery pack does not hold a charge for more than 2 hours after an overnight charge, replace it with a new 3.6-volt, 600 mAh battery pack with a connector that fits the socket in the battery compartment. You can order a replacement battery pack through your local RadioShack store.

Install the new battery pack as described below, then charge it for about 24 hours (see "Connecting and Charging the Battery Pack" on Page 8).

**Warning:** Dispose of old batteries promptly and properly. Do not burn or bury them.

### Cautions:

- Use only fresh batteries of the required size and recommended type.
- Be careful not to short the battery by touching the connector's pins with conducting materials, such as rings, bracelets, and keys. The battery pack or conductor might overheat and burn.

**Note:** To avoid losing memory numbers, install and begin charging the new battery pack within 30 seconds.

Follow these steps to replace the batteries.

1. Press down and slide off the battery pack compartment cover.
2. Lift the battery pack out of the compartment, then gently pull on the battery connector to disconnect it.
3. Insert the new battery pack's connector into the socket in the compartment and place the battery pack into the compartment.
4. Replace the cover.

If you have trouble replacing the battery, take the phone to your local RadioShack store for assistance.

**Important:** The EPA certified RBRC<sup>®</sup> Battery Recycling Seal on the nickel-cadmium (Ni-Cd) battery indicates RadioShack is voluntarily participating in an industry program to collect and recycle these batteries at the end of their useful life, when taken out of service in the United States or Canada. The RBRC program provides a convenient alternative to placing used Ni-Cd batteries into the trash or the municipal waste stream, which may be illegal in your area. Please call 1-800-THE-SHACK (1-800-843-7422) for information on Ni-Cd battery recycling and disposal bans/restrictions in your area. RadioShack's involvement in this program is part of the company's commitment to preserving our environment and conserving our natural resources.



---

## THE FCC WANTS YOU TO KNOW

In the unlikely event that your phone causes problems on the phone line, the phone company can temporarily discontinue your service. If this happens, the phone company attempts to notify you in advance. If advance notice is not practical, the phone company notifies you as soon as possible and advises you of your right to file a complaint with the FCC.

Also, the phone company can make changes to its lines, equipment, operations, or procedures that could affect the operation of this telephone. The telephone company notifies you of these changes in advance, so you can take the necessary steps to prevent interruption of your telephone service.

Your phone might cause TV or radio interference even when it is operating properly. To determine whether your phone is causing the interference, turn off your phone. If the interference goes away, your phone is causing it. Try to eliminate the interference by:

- moving your phone away from the receiver
- connecting your phone to an AC outlet that is on a different electrical circuit from the receiver
- contacting your local RadioShack store for help

If you cannot eliminate the interference, the FCC requires that you stop using your phone.

Some cordless telephones operate on frequencies that might cause interference to nearby TVs and VCRs. To minimize or prevent such interference, the base of the cordless telephone should not be placed near or on top of a TV or VCR.

## LIGHTNING

Your telephone has built-in surge protection to reduce the risk of damage from surges in telephone line and power line current. This protection meets or exceeds FCC requirements. However, lightning striking the telephone or power lines can damage your telephone.

Lightning damage is not common. Nevertheless, if you live in an area that has severe electrical storms, we suggest that you unplug your phone during storms to reduce the possibility of damage.

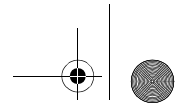

### Limited One-Year Warranty

This product is warranted by RadioShack against manufacturing defects in material and workmanship under normal use for one (1) year from the date of purchase from RadioShack company-owned stores and authorized RadioShack franchisees and dealers. EXCEPT AS PROVIDED HEREIN, RadioShack MAKES NO EXPRESS WARRANTIES AND ANY IMPLIED WARRANTIES, INCLUDING THOSE OF MERCHANTABILITY AND FITNESS FOR A PARTICULAR PURPOSE, ARE LIMITED IN DURATION TO THE DURATION OF THE WRITTEN LIMITED WARRANTIES CONTAINED HEREIN. EXCEPT AS PROVIDED HEREIN, RadioShack SHALL HAVE NO LIABILITY OR RESPONSIBILITY TO CUSTOMER OR ANY OTHER PERSON OR ENTITY WITH RESPECT TO ANY LIABILITY, LOSS OR DAMAGE CAUSED DIRECTLY OR INDIRECTLY BY USE OR PERFORMANCE OF THE PRODUCT OR ARISING OUT OF ANY BREACH OF THIS WARRANTY, INCLUDING, BUT NOT LIMITED TO, ANY DAMAGES RESULTING FROM INCONVENIENCE, LOSS OF TIME, DATA, PROPERTY, REVENUE, OR PROFIT OR ANY INDIRECT, SPECIAL, INCIDENTAL, OR CONSEQUENTIAL DAMAGES, EVEN IF RadioShack HAS BEEN ADVISED OF THE POSSIBILITY OF SUCH DAMAGES.

Some states do not allow limitations on how long an implied warranty lasts or the exclusion or limitation of incidental or consequential damages, so the above limitations or exclusions may not apply to you.

In the event of a product defect during the warranty period, take the product and the RadioShack sales receipt as proof of purchase date to any RadioShack store. RadioShack will, at its option, unless otherwise provided by law: (a) correct the defect by product repair without charge for parts and labor; (b) replace the product with one of the same or similar design; or (c) refund the purchase price. All replaced parts and products, and products on which a refund is made, become the property of RadioShack. New or reconditioned parts and products may be used in the performance of warranty service. Repaired or replaced parts and products are warranted for the remainder of the original warranty period. You will be charged for repair or replacement of the product made after the expiration of the warranty period.

This warranty does not cover: (a) damage or failure caused by or attributable to acts of God, abuse, accident, misuse, improper or abnormal usage, failure to follow instructions, improper installation or maintenance, alteration, lightning or other incidence of excess voltage or current; (b) any repairs other than those provided by a RadioShack Authorized Service Facility; (c) consumables such as fuses or batteries; (d) cosmetic damage; (e) transportation, shipping or insurance costs; or (f) costs of product removal, installation, set-up service adjustment or reinstallation.

This warranty gives you specific legal rights, and you may also have other rights which vary from state to state.

RadioShack Customer Relations, 200 Taylor Street, 6th Floor, Fort Worth, TX 76102

*We Service What We Sell*

12/99

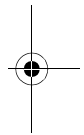
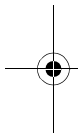

**RadioShack Corporation  
Fort Worth, Texas 76102**

UCZZ01660BA  
Printed in China

09A00

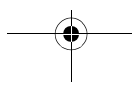

## Free Manuals Download Website

<http://myh66.com>

<http://usermanuals.us>

<http://www.somanuals.com>

<http://www.4manuals.cc>

<http://www.manual-lib.com>

<http://www.404manual.com>

<http://www.luxmanual.com>

<http://aubethermostatmanual.com>

Golf course search by state

<http://golfingnear.com>

Email search by domain

<http://emailbydomain.com>

Auto manuals search

<http://auto.somanuals.com>

TV manuals search

<http://tv.somanuals.com>