



Cat. No. 43-1036/1049  
**OWNER'S MANUAL**

Please read before using this equipment.

# Cordless Telephone

## with 10-Number Memory

**ET-536/10-Channel**  
**ET-549/25-Channel**



**RadioShack™**



## FEATURES

---

Your RadioShack ET-536 10 Channel/ ET-549 25-Channel Cordless Telephone with 10-Number Memory is designed to exacting standards that ensure reliability, long life, and outstanding performance.

Its features include:

**10 Channels (ET-536) / 25 Channels (ET-549)** — lets you change to a clearer channel during a call to reduce static interference.

**10-Number Memory Dialing** — lets you store up to 10 numbers in memory for easy dialing.

**Super CCT Noise-Reduction Circuitry** — provides clear telephone conversations, giving you sound clarity comparable to that of a corded phone.

**Security Access-Protection Code** — automatically prevents other cordless phone users from using your phone line while the handset is off the cradle.

**COM-LOK<sup>®</sup>** — ensures that other cordless phone users cannot use your phone line when the handset is on the cradle.

**Redial** — lets you quickly redial the last number dialed.

**Page** — lets you send a paging signal from the base to the handset to page someone or locate the handset if you misplace it.

**Flash** — sends an electronic switch-hook signal for use with special phone services, such as Call Waiting.

**Programmable Ringers** — let you select from four ringer types and change the type from the handset.

**Tone/Pulse Dialing** — lets you use your phone with tone or pulse service.

**Quick Talk** — lets you make or answer a call by simply lifting the handset from the base.

**Hearing-Aid Compatibility** — lets you use your phone with hearing aids that have a T (telephone) switch.

This telephone has been tested and found to comply with all applicable UL and FCC standards.

We recommend you record your phone's serial number here. The number is on the bottom panel of the base.



Serial Number: \_\_\_\_\_

© 1997 Tandy Corporation.  
All Rights Reserved.

COM-LOK is a registered trademark used by Tandy Corporation  
RadioShack is a trademark used by Tandy Corporation.

**Important Note:** Cordless phones such as this one require AC power to operate. When the AC power is off, you cannot dial out or receive incoming calls using your ET-536/ET-549. To be safe, you should also have a phone that does not need AC power to operate (not a cordless phone) so you can still make and receive calls if there is an AC power failure.

**Warning:** To prevent fire or shock hazard, do not expose this product to rain or moisture.

|  |   |   |
|--|---|---|
|   | <b>CAUTION</b><br>RISK OF ELECTRIC SHOCK.<br>DO NOT OPEN. |  |
| <b>CAUTION:</b> TO REDUCE THE RISK OF ELECTRIC SHOCK, DO NOT REMOVE COVER OR BACK. NO USER-SERVICEABLE PARTS INSIDE. REFER SERVICING TO QUALIFIED PERSONNEL. |   |   |



This symbol is intended to alert you to the presence of uninsulated dangerous voltage within the product's enclosure that might be of sufficient magnitude to constitute a risk of electric shock. Do not open the product's case.



This symbol is intended to inform you that important operating and maintenance instructions are included in the literature accompanying this product.

## READ THIS BEFORE INSTALLATION

Each device that you connect to the phone line draws power from the phone line. We refer to this power draw as the device's Ringer Equivalence Number, or REN. The REN is shown on the bottom of the base.

If you are using more than one phone or other device on the line, add up all the RENs. If the total is more than five, your phones might not ring. In rural areas, a total REN of three might impair ringer operation. If ringer operation is impaired, remove a device from the line.

## FCC STATEMENT

This telephone complies with Part 68 of *FCC Rules*. You must, upon request, provide the FCC Registration Number and the REN to your phone company. These numbers are located on the bottom panel of the base.

**Note:** You must not connect your phone to any of the following:

- coin-operated systems
- party-line systems
- most electronic key phone systems

# CONTENTS

---

|  |           |
|--|-----------|
| <b>Installation .....</b>                    | <b>5</b>  |
| Selecting a Location .....                   | 5         |
| Placing the Base on a Desk Top .....         | 5         |
| Mounting the Base on a Wall Plate .....      | 6         |
| Mounting the Base Directly on the Wall ..... | 8         |
| Connecting and Charging the Battery .....    | 9         |
| Setting the Dialing Mode .....               | 11        |
| Setting the Ringer Tone and Volume .....     | 11        |
| <b>Operation .....</b>                       | <b>12</b> |
| Making and Receiving Calls .....             | 12        |
| Changing the Channel .....                   | 12        |
| Using Redial .....                           | 12        |
| Using Flash .....                            | 13        |
| Using Tone Services on a Pulse Line .....    | 13        |
| Paging .....                                 | 14        |
| Memory Dialing .....                         | 14        |
| Storing a Number in Memory .....             | 14        |
| Entering a Pause .....                       | 15        |
| Dialing a Memory Number .....                | 15        |
| Chain-Dialing Service Numbers .....          | 15        |
| Testing Stored Emergency Numbers .....       | 15        |
| <b>Troubleshooting .....</b>                 | <b>16</b> |
| <b>Care and Maintenance .....</b>            | <b>18</b> |
| Replacing the Battery .....                  | 19        |
| The FCC Wants You to Know .....              | 20        |
| Lightning .....                              | 20        |

## INSTALLATION

### SELECTING A LOCATION

You can place the phone on a desk top or table, or mount it on a wall. Select a location that is:

- near an AC outlet
- near a telephone line jack
- out of the way of normal activities
- away from electrical machinery, electrical appliances, metal walls or filing cabinets, wireless intercoms, alarms, and room monitors
- away from other cordless phones

The base's location affects the handset's range. If you have a choice of several locations, try each to see which provides the best performance.

**Caution:** The supplied RadioShack adapter was designed specifically for your ET-536/ET-549. Use only the supplied adapter.

#### Notes:

- Your telephone connects directly to a modular telephone line jack. If your phone line jack is not a modular jack, you can update the wiring yourself, using jacks and adapters available at your local RadioShack store. Or, you can let the phone company update the wiring for you.
- The phone company will charge you for the installation of necessary jacks.

- The USOC number of the jack to be installed is RJ11C (RJ11W if you want to mount it on a wall plate).

### Placing the Base on a Desk Top

Follow these steps when you place the base on a desk, shelf, or table.

1. Plug one end of the supplied modular cord into the **TEL LINE** jack on the back of the base.

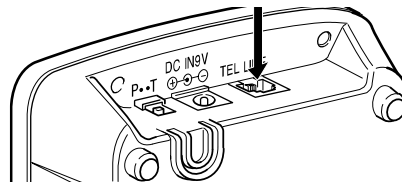

2. Insert the supplied AC adapter's barrel plug into the **DC IN 9V** jack on the back of the base.

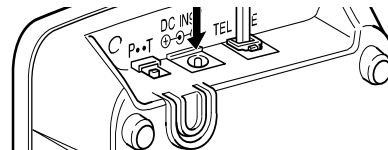

3. Route the adapter's cord through the strain relief slot on top of the base.

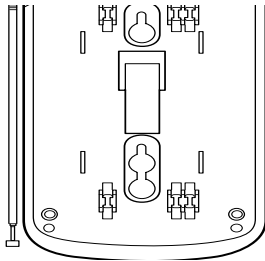

4. Plug the adapter into a standard AC outlet. The POWER indicator on the base lights.

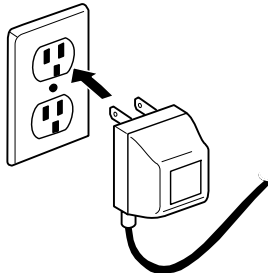

5. Plug the modular cord's other end into a modular phone line jack.

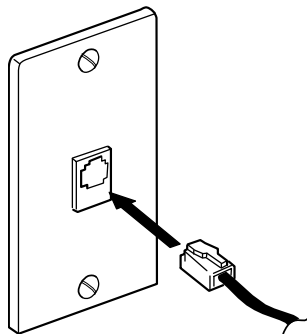

6. Fully extend the base's antenna and place it in a vertical position.

## Mounting the Base on a Wall Plate

1. Plug one end of a short modular cord (such as Cat. No. 279-390, not supplied) into the **TEL LINE** jack on the back of the base.

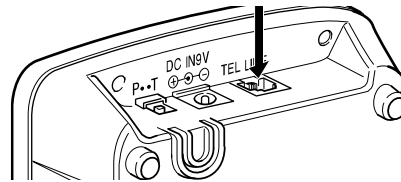

2. Insert the supplied AC adapter's barrel plug into the **DC IN 9V** jack on the back of the base.

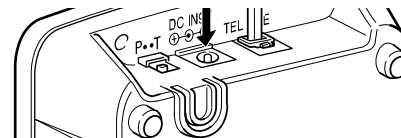

3. Route the modular cord through the top groove and the adapter cord through both grooves on the bottom of the base.

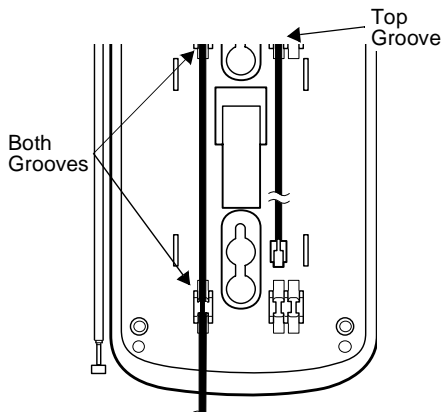

4. Plug the adapter into a standard AC outlet. The POWER indicator on the base lights.

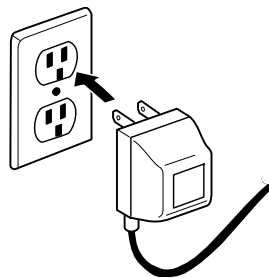

5. Plug the short modular cord's other end into the wall plate jack, then align the base's keyhole slots with the wall plate studs and slide the base downward to secure it.

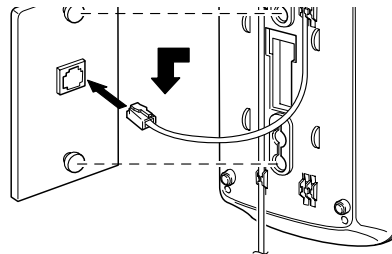

6. Press and lift out the handset holder, rotate it 180°, then snap it back into place so it holds the handset.



7. Fully extend the base's antenna and place it in a vertical position.

## Mounting the Base Directly on the Wall

For this mounting method, you need two wood screws (not supplied) with heads that fit into the keyhole slots on the bottom of the base.

1. Drill two holes  $3^{15}/16$  inches apart. Then thread a screw into each hole, letting the heads extend about  $5/16$  inch from the wall.

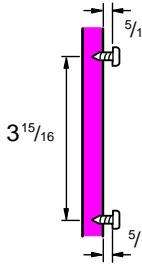

2. Plug one end of the supplied modular cord into the **TEL LINE** jack on the back of the base.

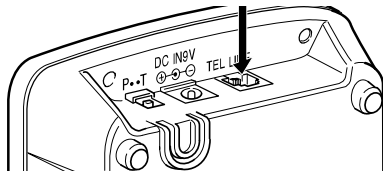

3. Insert the supplied AC adapter's barrel plug into the **DC IN 9V** jack on the back of the base.

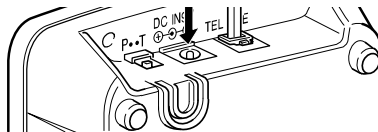

4. Route the modular and adapter's cords through both grooves on the bottom of the base.

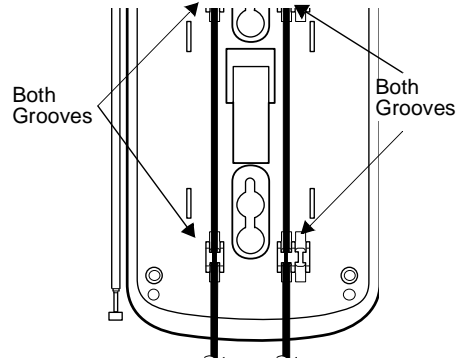

5. Plug the adapter into a standard AC outlet. The **POWER** indicator on the base lights.

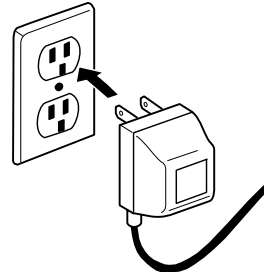



6. Plug the cord's other end into a modular phone line jack.

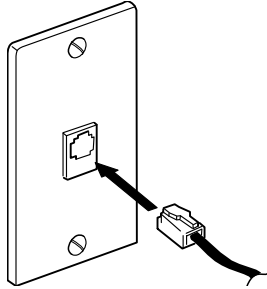

7. Align the keyhole slots with the mounting screws and slide the base downward to secure it.

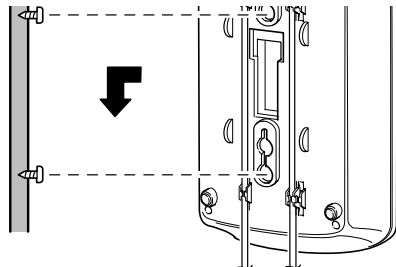

8. Press and lift out the handset holder, rotate it 180°, then snap it back into place so it holds the handset.

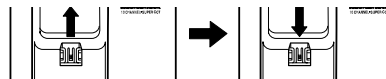

9. Fully extend the base's antenna and place it in a vertical position.

## CONNECTING AND CHARGING THE BATTERY

The ET-536/ET-549 comes with a rechargeable nickel-cadmium battery installed in the handset. Before using your phone, you must connect the battery then charge it for about 14 hours.

1. Remove the screw on the battery compartment cover on the bottom of the handset. Press down and slide off the handset's battery compartment cover in the direction of the arrow.

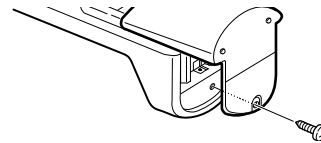

2. Insert the battery pack's plastic connector into the phone's socket. The plug fits only one way.
3. Replace the cover and tighten the screw.
4. To charge the battery, simply place the handset on the base.

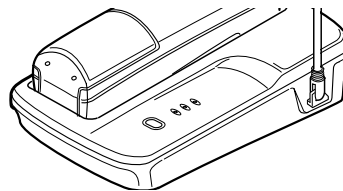

The CHARGE indicator on the base lights.

Recharge the battery when the BATT LOW indicator flashes.

**Notes:**

- If the CHARGE indicator does not light when you place the handset on the base, be sure the battery and AC adapter are correctly and securely connected.
- When you first use the phone after charging or recharging the battery, the phone might not work and you might hear an error tone. If this happens, return the handset to the base for about 5 seconds.
- If the BATT LOW indicator does not light, but the phone does not work, recharge the battery. The battery charge might be too low to light the indicator.
- If the battery pack gets weak during a call, the handset sounds a beep every 30 seconds, and the BATT LOW indicator flashes every 3 seconds. If this happens, you cannot make another call on the phone until you recharge the battery.
- About once a month, fully discharge the battery by keeping the handset off the base until the BATT LOW indicator lights. Otherwise, the battery loses its ability to fully recharge.

- Using a pencil eraser, clean the charging contacts on the handset and the base about once a month to make sure they are not dirty or tarnished.

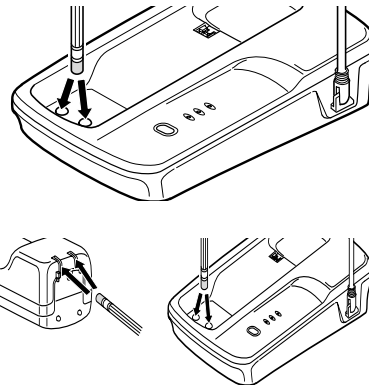

- If the battery gets completely discharged, the ET-536/ET-549 loses the security access-protection code. To reset the security code, place the handset on the base and charge the battery.
- The supplied battery should last for about a year. When the battery loses its ability to fully recharge, order a replacement battery from your local RadioShack store (see "Replacing the Battery" on Page 19).

## SETTING THE DIALING MODE

Set **P••T** on the back of the base for the type of service you have. If you are not sure which type you have, do this test.

1. Set **P••T** to **T** (tone).



2. Lift the handset and listen for a dial tone.
3. Press any number other than **0**.

**Note:** If your phone system requires that you dial an access code (**9**, for example) before you dial an outside number, do not press the access code either.

If the dial tone stops, you have touch-tone service. Leave **P••T** set to **T**.

If the dial tone continues, you have pulse service. Set **P••T** to **P** (pulse).

## SETTING THE RINGER TONE AND VOLUME

You can select one of four different ringer/tone volume settings when the phone is not in use.

1. Lift the handset. If you hear a dial tone, press **TALK** to turn it off.

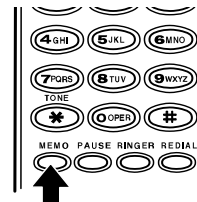

2. Press **RINGER**. The phone sounds the current ringer tone and volume.

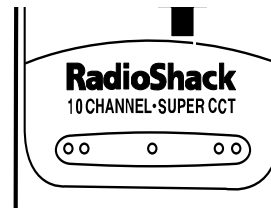

3. Repeatedly press **RINGER** until you hear the desired ringer tone and volume.

Each time you press **RINGER**, the ringer changes in the following order:

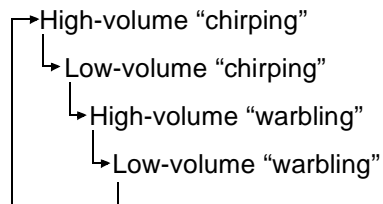

## OPERATION

### MAKING AND RECEIVING CALLS

To make or answer a call, lift the handset. Or, if the handset is away from the cradle, press **TALK**. The BATT LOW indicator on the handset and the IN USE indicator on the base light.

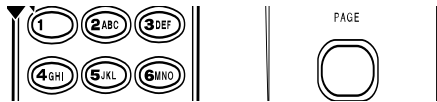

To end a call, place the handset on the cradle or press the handset's **TALK** button.

**Note:** If you press **TALK** to hang up and the phone does not disconnect, place the handset on the cradle or press **TALK** again while holding the handset closer to the base.

### CHANGING THE CHANNEL

If you notice interference, static, or noise during a call, you can press **CH** (channel) to find a clearer channel.

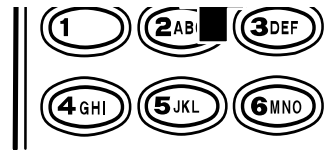

The ET-536/ET-549 changes to a different channel each time you press **CH**.

**Note:** If the handset is too far from the base, the channel might not change. Move closer to the base and try again.

### USING REDIAL

**REDIAL** lets you quickly dial the last number dialed. When you hear a dial tone, simply press **REDIAL**.

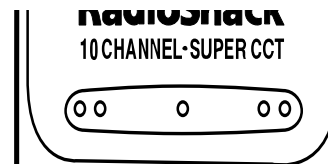

**Notes:**

- The redial memory holds up to 32 digits, so you can redial long-distance as well as local numbers.
- The redial memory also holds pause entries. See "Entering a Pause" on Page 15.
- The redial memory does not store a flash entry or any digits you press after **FLASH** (see "Using Flash.").

**USING FLASH**

**FLASH** performs the electronic equivalent of a switchhook operation for special services, such as Call-Waiting.

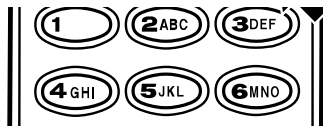

For example, if you have call waiting, press **FLASH** to answer an incoming call without disconnecting the current call. Press **FLASH** again to return to the first call.

**Note:** If you do not have any special phone services, pressing **FLASH** might disconnect the current call.

**USING TONE SERVICES ON A PULSE LINE**

Some special services, such as bank-by-phone, require tone signals. If you have pulse service, you can still use these special tone services by following these steps.

1. Be sure **P••T** is set to **P**.
2. Lift the handset from the cradle or press **TALK**.
3. Dial the service's main number.
4. When the service answers, press **-tone**. Any additional numbers you dial are sent as tone signals.

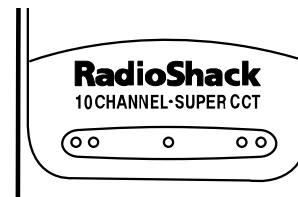

5. After you complete the call, return the handset to the cradle or press **TALK**. The phone automatically resets to the pulse mode.

## PAGING

To page the person who has the handset or to locate the handset when the phone is not in use, press **PAGE** on the base. The handset beeps five times.

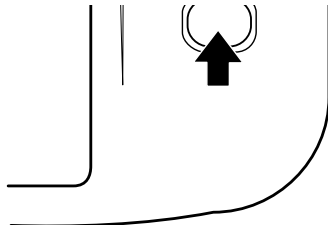

## MEMORY DIALING

You can store up to 10 numbers in memory, then dial a stored number by pressing a one-digit memory location number.

**Note:** Each number you store can be up to 16 digits long.

## Storing a Number in Memory

**Note:** An error tone sounds and the phone exits the programming mode if you wait more than 20 seconds between each key press.

1. Lift the handset. If you hear a tone, press **TALK** to turn it off.
2. Press **MEMO**. The BATT LOW indicator blinks.

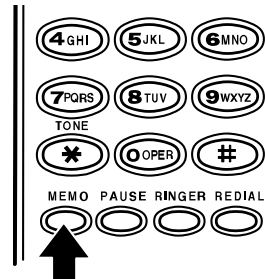

3. Enter the number and any **TONE** and **PAUSE** entries (see "Using Tone Services on a Pulse Line" on Page 13 and "Entering a Pause" on Page 15).

**Note:** Each **TONE** or **PAUSE** entry uses one digit of memory.

4. Press **MEMO**, then enter the memory location number (**0-9**). A single tone sounds to indicate that the number is stored.

**Note:** If five quick beeps sound, you have made an entry error and the number was not stored. Start again from Step 2.

5. For each stored number, write the person's or company's name next to the appropriate location number on the supplied MEMORY directory sticker. (Use a pencil in case you want to change the number later.) Attach the sticker to the phone.

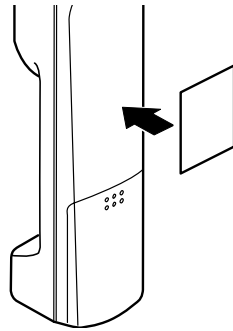

To erase a stored number, simply store a new number in its place. Or, skip Step 3, then press the memory location number (0-9) you want to clear. A tone sounds.

### Entering a Pause

In some telephone systems, you must dial an access code (9, for example) and wait for a second dial tone before you can dial an outside number. You can store the access code with the phone number. However, you should also store a pause after the access code to allow the outside line time to connect.

To do so, press **PAUSE**. Each press enters a 2-second pause. For a longer pause, press **PAUSE** additional times.

### Dialing a Memory Number

To dial a number stored in memory, lift the handset from the cradle or press **TALK**.

When you hear a dial tone, press **MEMO** and enter the memory location number for the number you want to dial.

### Chain-Dialing Service Numbers

When calling special services (such as alternate long distance or bank by phone), dial the service's main number first. Then, at the appropriate place in the call, press **MEMO** and the number for the location where the additional information is stored.

### Testing Stored Emergency Numbers

If you store an emergency service's number (police department, fire department, ambulance) and you choose to test the stored number, make the test call during the late evening or early morning hours to avoid peak demand periods. Also, remain on the line to explain the reason for your call.

## TROUBLESHOOTING

We do not expect you to have any problems with your phone, but if you do, the following suggestions might help.

| Problem   | Suggestion   |
|---|--|
| Low volume or unusual sounds.   | Someone has picked up another phone on the same line. Hang up the other phone.   |
| Severe noise interference.  | <ul style="list-style-type: none"> <li>• Press <b>CH</b> to change the channel.</li> <li>• Keep the handset away from computers, remote control toys, wireless microphones, alarm systems, intercoms, room monitors, fluorescent lights, and electrical appliances.</li> <li>• Move to another location or turn off the source of interference.</li> </ul> |
| The phone cannot be operated at a useful distance from the base because the signal becomes weak or noisy (handset's range has decreased). | <ul style="list-style-type: none"> <li>• Fully extend the base's antenna in a vertical position.</li> <li>• Be sure neither antenna is touching a metal surface.</li> <li>• Return the handset to the cradle, and recharge the battery.</li> </ul>   |
| The phone does not work or works poorly.  | Be sure the base's phone line cord and AC adapter are correctly and securely connected, and the battery is charged.  |
| The handset battery does not charge.  | <ul style="list-style-type: none"> <li>• Check the charging contacts on the handset and base. If they are dirty, clean them with a pencil eraser.</li> <li>• Be sure the battery is connected correctly.</li> </ul>  |



| Problem  | Suggestion  |
|--|---|
| Handset does not ring or receive a page.                 | <ul style="list-style-type: none"> <li>• The battery pack might be weak. Charge the battery.</li> <li>• Extend the base's antenna vertically.</li> <li>• Move the handset closer to the base.</li> <li>• Move the base away from other electrical devices and sources of noise.</li> </ul>  |
| The handset stops working or works poorly during a call. | <ul style="list-style-type: none"> <li>• Move the handset closer to the base.</li> <li>• Fully extend the base's antenna, and place it in a vertical position.</li> <li>• Make sure the charging contacts on the handset and base are clean.</li> <li>• Be sure the handset's battery is charged. (If the battery power is too low, it does not have enough power to light the BATT LOW indicator.)</li> <li>• If the base loses power while the handset is off of it, the security access-protection code might change. Restore power to the base, then place the handset back on the base. The CHARGE indicator lights, indicating that the code is set again.</li> </ul> |
| The call is too noisy.                                   | Change channels or hang up and redial the number.   |

If you still have problems, disconnect the phone. If other phones on the same line work properly, the fault is in this phone or its installation. If you cannot find the problem, take your phone to your local RadioShack store for assistance

## CARE AND MAINTENANCE

Your RadioShack ET-536 10 Channel/ET-549 25-Channel Cordless Telephone with 10-Number Memory is an example of superior design and craftsmanship. The following suggestions will help you care for your cordless telephone so you can enjoy it for years.



Keep the phone dry. If it gets wet, wipe it dry immediately. Liquids might contain minerals that can corrode the electronic circuits.



Handle the phone gently and carefully. Dropping it can damage circuit boards and cases and can cause the phone to work improperly.



Use and store the phone only in normal temperature environments. Temperature extremes can shorten the life of electronic devices and distort or melt plastic parts.



Keep the phone away from dust and dirt, which can cause premature wear of parts.



Wipe the phone with a damp cloth occasionally to keep it looking new. Do not use harsh chemicals, cleaning solvents, or strong detergents to clean the phone.

Modifying or tampering with the telephone's internal components can cause a malfunction and might invalidate your telephone's warranty and void your FCC authorization to operate it. If your phone is not performing as it should, take it to your local RadioShack store for assistance. If the trouble is affecting the phone lines, the phone company might ask you to disconnect your phone until you have resolved the problem.

## REPLACING THE BATTERY

If you follow the instructions in "Connecting and Charging the Battery" on Page 9, the battery should last about one year. If the battery will not hold a charge for more than 2 hours after an overnight charge, replace the battery with a new 3.6 V, 300 mAh battery with a connector that fits the socket in the battery compartment. You can order a replacement battery through your local RadioShack store.

Install the new battery as described below, then charge the battery (see "Connecting and Charging the Battery" on Page 9).

**Note:** To avoid losing phone numbers stored in memory, try to install and begin charging the new battery within 1 minute.

1. Remove the screw on the battery compartment cover on the bottom of the handset. Press down and slide off the handset's battery compartment cover in the direction of the arrow.

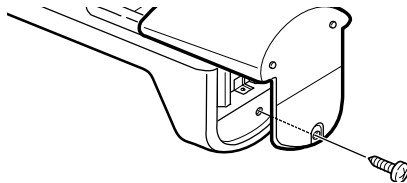

2. Gently pull on the battery connector to disconnect it, then remove the battery.
3. Insert a fresh battery and insert its connector into the socket inside the battery compartment.
4. Replace the cover and tighten the screw.

### Cautions:

- You must use a replacement battery of the same size and type.
- Do not dispose of the battery in a fire because it might explode.
- Do not open or mutilate the battery.
- Be careful not to short the battery by touching it with conducting materials, such as rings, bracelets, and keys. The battery or conductor might overheat and burn.

**Important:** This product contains a rechargeable nickel cadmium battery. At the end of the battery's useful life, it must be recycled or disposed of properly. Contact your local, county, or state hazardous waste management authorities for information on recycling or disposal programs in your area. Some options that might be available are: municipal curb-side collection, drop-off boxes at retailers such as your local RadioShack store, recycling collection centers, and mail-back programs.

---

## THE FCC WANTS YOU TO KNOW

In the unlikely event that your phone causes problems on the phone line, the phone company can temporarily discontinue your service. If this happens, the phone company attempts to notify you in advance. If advance notice is not practical, the phone company notifies you as soon as possible and advises you of your right to file a complaint with the FCC.

Also, the phone company can make changes to its lines, equipment, operations, or procedures that could affect the operation of this telephone. The telephone company notifies you of these changes in advance, so you can take the necessary steps to prevent interruption of your telephone service.

Your phone might cause TV or radio interference even when it is operating properly. To determine whether your phone is causing the interference, turn off your phone. If the interference goes away, your phone is causing the interference.

Try to eliminate the interference by:

- Moving your phone away from the receiver
- Connecting your phone to an AC outlet that is on a different electrical circuit from the receiver
- Contacting your local RadioShack store for help

If you cannot eliminate the interference, the FCC requires that you stop using your phone.

Some cordless phones operate at frequencies that might cause interference to nearby TVs and VCRs. To minimize or prevent such interference, the base of the cordless phone should not be placed near or on top of a TV or VCR.

## LIGHTNING

Your telephone has built-in lightning protection to reduce the risk of damage from surges in telephone line and power line current. This lightning protection meets or exceeds FCC requirements. However, lightning striking the telephone or power lines can damage your telephone.

Lightning damage is not common. Nevertheless, if you live in an area that has severe electrical storms, we suggest you unplug your phone during storms to reduce the possibility of damage.



# NOTES

---

---

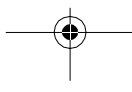
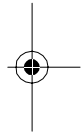
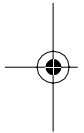

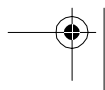
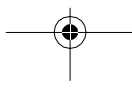
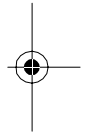
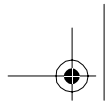

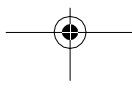
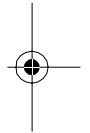

### Limited One-Year Warranty

This product is warranted by RadioShack against manufacturing defects in material and workmanship under normal use for one (1) year from the date of purchase from RadioShack company-owned stores and authorized RadioShack franchisees and dealers. In the event of a product defect during the warranty period, take the product and the RadioShack sales receipt as proof of purchase date to any RadioShack store. RadioShack will, at its option, unless otherwise provided by law: (a) correct the defect by product repair without charge for parts and labor; (b) replace the product with one of the same or similar design; or (c) refund the purchase price. All replaced parts and products, and products on which a refund is made, become the property of RadioShack. New or reconditioned parts and products may be used in the performance of warranty service. Repaired or replaced parts and products are warranted for the remainder of the original warranty period. You will be charged for repair or replacement of the product made after the expiration of the warranty period.

This warranty does not cover: (a) damage or failure caused by or attributable to acts of God, abuse, accident, misuse, improper or abnormal usage, failure to follow instructions, improper installation or maintenance, alteration, lightning or other incidence of excess voltage or current; (b) any repairs other than those provided by a RadioShack Authorized Service Facility; (c) consumables such as fuses or batteries; (d) cosmetic damage; (e) transportation, shipping or insurance costs; or (f) costs of product removal, installation, set-up service adjustment or reinstallation.

EXCEPT AS PROVIDED HEREIN, RadioShack MAKES NO EXPRESS WARRANTIES AND ANY IMPLIED WARRANTIES, INCLUDING THOSE OF MERCHANTABILITY AND FITNESS FOR A PARTICULAR PURPOSE, ARE LIMITED IN DURATION TO THE DURATION OF THE WRITTEN LIMITED WARRANTIES CONTAINED HEREIN. EXCEPT AS PROVIDED HEREIN, RadioShack SHALL HAVE NO LIABILITY OR RESPONSIBILITY TO CUSTOMER OR ANY OTHER PERSON OR ENTITY WITH RESPECT TO ANY LIABILITY, LOSS OR DAMAGE CAUSED DIRECTLY OR INDIRECTLY BY USE OR PERFORMANCE OF THE PRODUCT OR ARISING OUT OF ANY BREACH OF THIS WARRANTY, INCLUDING, BUT NOT LIMITED TO, ANY DAMAGES RESULTING FROM INCONVENIENCE, LOSS OF TIME, DATA, PROPERTY, REVENUE, OR PROFIT OR ANY INDIRECT, SPECIAL, INCIDENTAL, OR CONSEQUENTIAL DAMAGES, EVEN IF RadioShack HAS BEEN ADVISED OF THE POSSIBILITY OF SUCH DAMAGES.

Some states do not allow the limitations on how long an implied warranty lasts or the exclusion of incidental or consequential damages, so the above limitations or exclusions may not apply to you. This warranty gives you specific legal rights, and you may also have other rights which vary from state to state.

RadioShack Customer Relations, Dept. W, 100 Throckmorton St., Suite 600, Fort Worth, TX 76102

*We Service What We Sell*

1/97

**RadioShack**  
**A Division of Tandy Corporation**  
**Fort Worth, Texas 76102**

UDZZ01500ZZ  
Printed in Hong Kong

3A7



## Free Manuals Download Website

<http://myh66.com>

<http://usermanuals.us>

<http://www.somanuals.com>

<http://www.4manuals.cc>

<http://www.manual-lib.com>

<http://www.404manual.com>

<http://www.luxmanual.com>

<http://aubethermostatmanual.com>

Golf course search by state

<http://golfingnear.com>

Email search by domain

<http://emailbydomain.com>

Auto manuals search

<http://auto.somanuals.com>

TV manuals search

<http://tv.somanuals.com>